

**This volume was donated to LLMC
to enrich its on-line offerings and
for purposes of long-term preservation by**

Hawaii State Archives

This volume contains handwritten text that may be partially illegible due to age, penmanship, or deterioration of the medium. LLMC has scanned the material in the same format and page order in which it is maintained in the Hawaii State Archives.

Index to Volume VIII Award Book

Number	Names	Page	Number	Names	Page	Number	Names	Page
9402	Kikiau (no Lino W)	708	4095	Kahookalahala	51	2811	Kahui	120
8104	Kaula	721	9102	Kaauhaukimi	"	7408	Kawahumana	121
3979	Kaulalani	742	4097	Kuaana	52	2926	Kahukai	122
240 ^R	Kulu	748	5135	Kekipi	53	7417	Kunkaliu	123
7277 ^B	Kakae	761	8931	Keke	"	8419	Kealainana	"
			4936	Kapowahou	54	7771	Kahulukaai	125
			9104	Kahahane	"	8845	Kaholopapa	129
			4185	Kaluau 2	55	8808	Kekelaiiku	130
			5063	Kama	56	5065	Kupala	"
3107	Kaili	1	8921	Kenui	59	4955	Kapuki	131
3539	Kapule	5	5074	Kauhau	60	5855	Kaniho	"
3545	Keawamahi	6	5137	Kahukahukai	61	8987	Kunaka	132
3104	Kaalemakule	7	4079	Kuapu	63	6775	Kekuli	133
8808	Kekelaiiku	8	4082	Kamvai	"	4853 ^B	Kuhaku	136
5742	Kaluahinui	"	5785	Kanakaole	65	4876 ^B	Kaili	137
5551	Kekua	10	4819	Kaanaana	66	3038	Koalakahi	"
3520	Keawe W	"	6288	Kealohanui	67	5176 ^B	Kaleo	138
3523	Kalahouka	13	4171	Kolanoa	71	3036	Kupupu	"
8807	Kuikona	15	8654	Kupaole	74	9024	Kikiana	139
399	Kainu A	16	8550	Kuuhulu	75	4939	Kaku	140
5324	Keakini	18	8462	Kawalaau	77	4853	Kuwaloa	142
3103	Kutawala	20	5299	Kali	78	4849	Kalohelau	145
3109	Kuheloa	24	8866	Kuniko	79	5004	Kahela	146
3847	Kauaiwa	"	6429	Kuialii	82	4571	Kualei	148
2424	Kawapalaole	"	9021	Kamui	"	2965 ^B	Kamule	149
5282	Kanepuakewo	22	4649	Kealakane	83	4670 ^B	Keke	"
8289	Kaumaka	27	5267	Kauau	85	3108	Konoia	150
8285	Keawe	29	8462 ^B	Kailianu	"	5087	Kepea	"
2085	Keamalu (no Unuau)	31	9671	Kekahuna	86	3324+3648	Kala	152
1304	Keawekolua	"	8602	Kekua	87	8842	Kaawapupuole	153
1647	Kekui (no Kaikuaana)	33	5294	Koi	88	8833	Kaipu	154
1305	Kahuaina	"	6414	Keawe	89	8834	Kalawala	156
1308	Kalua	34	7971 ^H	Kalia	"	7966	Keaonui	159
1650	Kapali	35	5397	Kuuiwi	90	3413 ^B	Kuaki	160
1868	Kanao	36	6425	Kahukulanui	91	4909	Kaleu	162
1871	Kalakuaole	"	8655	Kahopahi	"	5023	Kohia (Golia)	163
1865	Kaitauapule	37	8652	Kahela	95	5199	Kueha	165
1873	Kamano	38	3759 ^B	Kaili	"	5084	Kuniku	166
1813	Keaka I	"	3720 ^B	Kaumaiawa	96	4971	Kalehua	167
1629	Kaaukai	39	8627	Kauhikapo	"	5205	Kaholomoana	168
2126	Keoho	40	6825	Kalamiahine	97	4981	Kalimaelele	"
1302	Keau	41	9000	Kawauki	99	4984	Kale	170
1380	Kahaakeo	"	6840	Kuoha	100	5142	Kaliwaa	"
8290	Kinowa	"	8557	Kaluwala	"	5170	Kalawala	171
8287	Kawainui	42	8558	Kaleo	"	5024	Keaka	174
8291	Kaalu	"	7425	Kawalo	103	5087	Kahawaioloa	"
6283	Kaheakulani	45	7342	Kuokoa L.	105	7583	Kuheloa	176
6290	Kapopule	"	2925	Kealikuluhulu	109	5101	Kalua	177
4175	Kaluau 1	46	4305	Kahala	114	5085	Kaipu	"
4187	Kahookano	47	7414	Kapule	115	8933	Kealikuwakaole	179
5187	Kaluau 3	48	2849	Kaanaana	116	6344	Kalauakea	181
4899	Kalamaike	49	2907	Keawe	119	6285	Kawalo	182
4985	Kiaki	50	7374	Kapule	120	8982	Kalamo	183

Index to Volume VIII Award Book

Number	Names	Page	Number	Names	Page	Number	Names	Page
5012	Kahanamui	184	4080	Kahilina	248	4131	Kahoonohano	301
6292	Kawahue	"	9081	Kaape	"	5507	Kanui	302
5798	Kueaw	186	9833	Kuachu	250	8584	Keoho	305
4901	Kauwipalaoa	"	9276	Kiolea	251	4960	Kapahu	306
5001	Kahinu	187	9072	Keolo	"	5162	Kamohai	307
8930	Kaluau (no Kahimealii)	190	2444	Kawakuhia	252	5392 ^d	Kanakaohai	308
5010	Kaahu	192	2843	Kaanaana	"	5392 ^b	Kawahine (ois M.)	309
5797	Kame	195	9215	Kaahu	253	5525	Koki	309
8934	Kaianui	"	9266	Keikinui	"	3700 ^b	Keomalu	310
8910	Kawainui	196	9273	Kawahine	254	3703 ^b	Kauahi	317
8955	Kulow	197	9171	Keaka	255	8809	Kekauwa	"
6300	Kauwinui	"	11031	Kimo (James)	256	3705 ^b	Koolau	313
5071	Kaili (no Kalahale)	198	4090	Kauakahi	257	5836	Kahawaiolaa	314
5203	Kauhale	"	5793	Kaiauwoku	258	3190	Kealina	"
168 ^b	Kowilikopaa	200	4951	Kailua	259	3905 ^c	Kolia (ois Lolia)	316
169 ^b	Koahouka	"	4948	Keainini	260	5459 ^f	Kaahaien	317
4926	Kuapa	202	5794	Keili	"	5016	Kuapuu	319
4902	Kekahuna	"	11085	Keowai	261	5498	Kaumakaawakea	"
4912	Kaniau (no Kaholoakahiki)	203	4953	Kauwenui	"	5395	Kepea	320
4903	Kunakaale	204	5736	Kaha	262	5423	Kauahi	320
4900	Kahuliakaua	206	4289	Kauhikou	263 Vol. 8 + 438 Vol. 9	6455	Kaha	324
4200	Kahena	209	1956	Kupaula	265	5306	Kaaukai	325
3528	Koa	211	4266	Kalalawala	267 + 442 Vol. 6	3905 ^h	Kuwa	326
2225	Kuamui	215	4431	Kaumaka	267	6411	Kilaua	326
3524	Kukele	216	2246 ^g	Kaliliha	270	7972	Kalawahinemui	327
3525	Keliolo	217	" ^c	Kaa	"	3905 ^f	Konohia	3.
5277	Kanakaaloo	"	" ^g	Kapule	271	6234	Koleamoku	"
3522	Kawana	218	8164 ^o	Keakua	"	5521 ^b	Kanewaa	328
8672	Kaluau	"	2246 ^h	Kealakaia	274	5499	Kauhi I.	"
5280	Kahuhu	219	3699 ^b	Kainoakou	275	5392 ^e	Kauhi J.	"
492	Kepea	221	8164 ^l	Kalima	277	5508	Kaapaahili	331
5286	Kaneaupio	222	" ^f	Kawaala	279	5512	Kulani	332
8870	Kamene	223	2421	Kaawa A.S.	281	5516 ^c	Kai	334
5285	Kahiewalu	224	3710 ^b	Kanakaualii	282	5393	Kealawala	336
3546	Kupalii	225	4427	Kanakaui	283	2468	Keaw	338
3105	Kaaa	226	3507	Kawahine	284	5520 ^b	Kulawala	339
1759	Kaupa	227	4295	Kapiho	285	6482	Kuana	340
2428	Kaowaa	228	4426	Kahinu	286	4432	Kahikiula	342
8806	Kalapuna	229	3517	Kanuisheana	287	3438	Kumahana	343
3527	Kamohai	231	4277	Kaholoaulani	288	3451	Kapahi (or Napahi)	"
3647	Kapuhohi	233	4416	Kauaiwa	290	6405	Kapahu	344
6377	Kaulaloa	234	3113	Kauakahi	"	3515	Kuamoo	345
9657	Kekeale	"	4377	Keawe	291	4440	Keino	346
7919	Kaiahauna	"	5780	Kumaihoa	292	4444 ^b	Keapu	"
3655	Kanewahine	237	5174	Koololo	294	3447	Kepe	347
3605	Kaiaholomoku	238	5786	Kamai	"	3529	Kaape	348
9010	Kahaawilau	239	3033	Kaili	295	3431	Kalamiaa	"
5109	Kuie	243	4927	Kaukuaale	"	3457	Kamaka	349
9799	Konohia	"	3024	Kanemi	296	5497	Kawahilakaale	350
1761	Kawahae	244 + 387	8187 ^b	Kuhia	297	7686	Kawaa	351
5811	Kumumui (no Kauamui)	244	5498 ^b	Kahuhu	"	3433	Kuana	352
9149	Kalawa	246	4796	Kealoha	298	3458	Kikaho	"
4076	Kamakuiwa	247	5511	Kamaha	300	3428	Kekai	353

Index to Volume VIII Award Book

Number	Names	Page	Number	Names	Page	Number	Names	Page
5459 ^V	Kaliki	356	3177	Kaairamahi	425	6147 ^N	Kekona	491
3462	Kalomij	"	2461	Kanehailua	"	4120 ^B	Kapohaku	492
3435	Kaohula	358	2447	Kaawa	426	6147 ^C	Kauhiku	494
5459 ^X	Kamauu	359	2412	Kauhi	427	"	Kailiuli	496
2433	Kuhikapu	361	3459	Keawe	428 ^{28.395.57}	"	Kanau	499
3460	Kaia	362	3443	Kamai	430	"	Kaauana	"
3452	Kaili	364	4120	Kapohaku	432	6148 ^H	Kahiawalu	503
8305	Kalua	"	4518	Kekanaka	433	"	Kauluhua	504
5495	Kepoa	365	6291	Kauhauui	"	"	Kauinui	"
3510	Kaakina	"	4403 4812	Kanohoua	437	"	Keeka	505
3434	Kaamakua	366	4816	Kaaiole	"	"	Kamalalawalu	506
4303 ^V 4304	Kekahuna	367	4814	Kanakaakai	438	4876 ^I	Kapule	508
4063	Kanehikili	368	4182	Kahue	"	6776	Kaiaikalipo & Kanukule	"
6389	Kahaleole	369	8928	Kalua	440	5173 ^E	Kaimihaku	509
520 ^B	Kalaipaihala	"	176 ^B	Kamakaukau	442	4405 ^Z	Kamakahuana	510
8623	Kamakakehau	372	138 ^B	Kawainui	443	3561	Kaumuulii Asia	513
4417	Keoili	374	8946	Kaawa	444	1438	Ku	515
2474	Kuhi	375	4405 ^{NH}	Kukeleaumoku	445	3111:3559	Kapule Debora	516
5521	Koofu	377	"	Ku	446	3600	Keolanui	519
4444	Kaahu	379	"	Kaakaa	447	7944	Kahu	520
4438 ^B	Kekaula	"	2391	Kuapuu	449	8521:9663	Kaialaweikeaw	522
4896	Kekuahaleole	382	3579	Kuhouwaha (no Mahuka)	"	3598	Kihepono Jeremiah	523
3448	Kaalapahi	"	1653	Keaka	450	5143	Kaahiki	524
5118	Kaualeliki	383	4149	Kapohuli	"	5190	Kekuaiti	525
5123	Kamehoalani	384	3275 ^E	Kalo	451	4538:4556:4913	Kameho Ma	526
4138	Kekahuna	385	4405 ^D	Kaulahiwa	452	5090	Koae	530
3450	Kapulu	386	3275 ^U	Kaiolani	453	3607	Kaunu	531
3436	Kapahi	389	4284	Kekumoku	456	5554	Kao	"
3441	Kapaula	393	4405 ^D	Kaalepo	458	3259	Kapau	532
2426	Kaiwi	394	4243 ^C	Kauwawahine	460	3026	Kaulimakule	533
4049	Kaniolo	"	4251	Kaauakulani	"	5434	Kapau	535
2466	Kahula	396	4243	Keliipoina	461	6328	Kaulaulapawale Alias	536
2482	Kane	"	4246	Kalo	463	4308 ^C	Kaupano	541
3434	Kaapowale	397	3981	Kahope	467	5272 ^D	Kealoha	"
4918	Kapua	"	4255	Kuhope	467	3234 ^C	Kaianui	542
3437	Kaliula	398 ^V 402	4247	Kahue	468	1379	Kapule	544
5623	Kualii	399	4243 ^B	Kukalehua	"	7348	Kaiwi	546
3444	Kalopa	400	4263	Kapule	471	5561 ^L	Kahaleko	548
5622	Kameakala	401	4262	Kailiivi	475	7341	Kekahumanui	549
6466	Kapua	403	4256	Kenao	476	7399	Kahaleola	"
5494	Kiahuikala	"	4250	Kau	477	7332	Kahoaee	550
8889	Kopa	404	4065	Kahiki	479	7349	Keohokalole	551
4121	Kaai	406	6145 ^X	Kaleiku	480	7963	Kukea	552
5326	Kalaeloa	407	"	Kahoa	484	5249	Kuapuu	553
2487	Kahue	"	"	Kuamo	485	7965	Kawahaciai	553
5501	Kaumana	409	6147 ^H	Kuheana	"	8575	Kaiahauhi	554
2419	Kamahiau	411	"	Kihelo	486	7958	Keliimohokaha	557
4133	Kaai	412	"	Kaowao	"	7960	Kahalo	"
5420	Kulamea	413	"	Kapapuluole	487	1812	Kau	558
3446	Kaahu	417	"	Kamalii	488	7961	Kaanehe	559
4136	Kahale	419	"	Kaopumana	489	5769	Kapule	559
4673 ^B	Kalilo	420	"	Kumauna	490	5788	Kauaawa	561
2489	Kuhelauakia	423	"	Kapuwahi	"	5562	Kahoua	562

Index to Volume VIII Award Book

Number	Names	Page	Number	Names	Page	Number	Names	Page
1449	Kaumoalii	564	7953	Kuahine	622	208 ^c	Kahaipo	674
5773	Kalepaa	568	7968	Kahaunapa	622	204 ^B	Kanele	"
5770	Kalua 2	"	7084	Kailikulani	623	9513	Kapalapala	"
5787	Kaneua	571	7075	Kalamakini	624	9504	Kaulau	675
5561 ^B	Kaukauli	"	7082	Keakuahoa	625	9510	Kekuaupuhi	676
5786	Kapela	573	6402	Kanahelo	626	7186	Keaka	"
5566 ^E	Keahualaumoku	574	1413	Kaua	627	9502	Kekaw	677
7320	Kahililoa	"	7912	Kaniu	"	7188	Kahula	678
7361	Kapiipui	575	7913	Kaaneke	628	206 ^B	Kaoni	"
5561 ^D	Kauihana	576	7337	Kaaitoole	629	9699 ^c	Kaikuino	679
7327	Keohulu	577	7345	Kahualaalaa	"	4747	Kama	"
9752	Kauhikoa	578	7368	Kamakahu	630 ^B	632	Kumukhea	680
9428	Koikua	579	7380	Kauakahi	630	7290	Kaukai	681
7212	Kaiaino	580	7346	Kainā	631	7052	Kiowai	"
8455	Kanapi	"	7464	Keawelwaale	633	7046	Kaolelo	682
7203	Kahawanui	581	7460	Kumukhea	634	7003.9789	Kau	"
7797	Kamohoulii	582	7467	Kapatauhulu	"	7016 ^B	Kupo	683
9242	Keawehookino	"	8212	Kalino	635	7293	Kaipo	"
9060	Koiku	583	9242	Kapohaku	"	7069	Keawe	684
9237	Kahiona	584	7198	Kukahuna	636	226 ^B	Kekoa	"
7197	Kamahela	585	7204	Kapoi	"	9677	Kamahine	686
8157 ^E	Kamohaku	"	6985	Kuniola	637	7293 ^B	Kamauli	687
7035	Kauwaiwa	587	8757 ^D	Kalawaiaki	638	9787	Kauhanni	"
8455 ^C	Kuluiki	588	8523 ^C	Kaaua	640	8538	Kukui	688
909	Kameihua	591	6241	Kanakamaku	641	8531	Kalua	"
7313	Kaawa	"	7076	Kupike	"	8197 ^D	Kaumaymalani	689
7606 ^B	Keliinui	592	7077	Kahuakailoa	"	7002	Kaonohi	690
7451 ^B	Kamohopaa	596	7951	Kaneua	642	7292: 8197 ^B	Kahikina	691
7600: 7312	Keaw 3	597	4070 ^B	Kaholo	644	8957	Kuhamea	"
8754 ^B	Kelikaulolo	"	7914	Kekipi	"	8959	Kuamoo	693
" ^C	Keaurakui	598	7496 ^B	Keawehua	646	7291	Keoholau	"
8781	Keohokuna	599	7073	Kapae 1	647 ^B	649	Kamaui	694
1633	Kalawana	599 ^B : 662 ^B	9126	Kakauola	647	228 ^B	Kaeha	"
8787 ^B	Kupete	600	7335	Kaanaana	648	5182	Kalikelike	695
" ^D	Kauka	601	7350	Kialoa	650	8900	Kamuku	696
9228	Kukalohe	602	7690	Kulou	651	9002	Kawaken	698
3434 ^B	Kahaoi	"	7483	Kuluu	652	6486	Kehoacae	699
3435	Kapahu	603	7897	Kahumui	654	2851	Keoni	700
3433 ^B	Kahookeli	"	1008	Ku	656	1328	Kahuakoma	701
3436 ^B	Kaeha	604	858	Kamealoha	657	1318	Kahalapalaa	"
4053: 7363	Kuupaka	"	5715	Kulauwa	658 ^B : 865 ^B	716	Kaawa	702
9428 ^D	Kama	606	5544	Kalaau (no Aieono)	659	1313 ^B	Kauwahi	703
8157 ^F	Kapaaku	607	4250 ^B	Keliopunui	661	8659	Kuapuu	705
9423	Kukele	610	4202	Kamaka	663	5888: 9347	Kapua	706
7731	Kapohaku	"	1034: 8400	Kapauhi Kukelelei	664	5839: 5669: 9346	Kupikea	707
9419	Keawe	611	9725	Koko	667	8580	Keliwawaiolo	708
9428 ^F	Keawikaapali (or Kauhikaapali)	612	9722	Keoni	668	1321	Kalanikilo	710
9236	Kahaulewahine	"	212 ^B	Kanepaahana	"	1758	Kalaoni	713
3738 ^B	Kuhana	613	9745 ^G	Kaha	670	4149	Kapohuli	714
9061	Kanae	616	8164	Kaiwo	671	6289	Kamelele	715
7890	Kukonoa	"	205 ^B	Kalua	672	10025	Kaneakua	716
456	Kaai	619	207 ^B	Kuheana	"	10058	Kannele	718
7870	Kamohai	620	9508	Kekuanui	673	11095	Kalino	719

Index to Volume VIII Award Book

Number	Names	Page	Number	Names	Page	Number	Names	Page
3521	Kekuapaa	719	7687	Leiona	60	10145	Manaole	92
6288	Kelohaniu	720	9990	Lolo	71	4750	Maia	93
5709	Kaicholua	721	6691	Lili	72	6837	Maalulu	101
4176	Kanemanaole	722	6652	Lima	74	2768 ^B	Maio	113
6354	Keawe	724	5476	Lapaku	83	3703	Mao	117
6365	Kahuna	725	6738	Lukeluhe	88	10144	Makahiki	128
4933	Kapule	"	10364	Lonokaho	110	4739	Meiki	141
4947	Kahiko	726	9951	Laanui S.	111	4736	Moakee	142
8632	Keawe	727	2692	Luahiwa	115	10155	Moa	143
8945	Kahawaiapu	"	5176 ^C	Liili	134	4741	Meru	151
8942	Karuhemahema	730	2986	Laaihanu	144	10148	Moamaki	157
8943	Kamao	731	5376	Lono	148	10149	Mokuahine	160
8941	Kihia	"	4686	Luaniu	206	4712	Mokaino (Kiko)	167
8951	Kailua	732	3270	Luka	240	4719	Moukaola	"
8913	Kapule	733	10014	Luahine	255	4711	Moulow	171
4945	Kekahuna	"	9988	Lio	256	4716	Mohoe	185
4953	Kaemui	734	10005	Laa (via Laamaikahiki)	273	6672	Moa	189
5002 ^B	Kupaa	735	3258	Laka	376	6670	Mohi	194
5012 ^B	Kanakaole	736	3259	Luachiu	422	3019	Mohao	209
4519	Kaanaana	"	4832	Liipali	435	3314	Mokabalu	238 ^B 525
160 ^B	Kapuakali	741	5139	Lala	466	10074	Moa	250
6521 ^B	Kuhookano	742	3802	Lohelohe	478	10110	Moadakia	257
6375	Kahapu	743	3803	Lalahua	479	4723	Mohoe	258
7136:6362	Kakalekapu	"	5260	Lopahilikona	578	3720	Mokaimu	260
165 ^B	Konakani	745	9918	Lumihai	556	1770	Moa	274
140 ^B	Kailimeau	746	9680 ^C	Lohi	579	3698 ^B	Mohoe 2	280
161 ^B	Kauhi	"	8754 ^D	Lia	595	10285	Mokanana	313
144 ^B	Kewaha	747	7277 ^D	Lono	608	3156	Mohula	315
167 ^B	Kaiwinui	748	7739	Lupea	609	52	Moku	321
240 ^S	Kekahuna	749	1845	Lio	613	5392 ^E	Mokahikipuni	323
" ^S	Kukakara	"	6736	Lono	625	4753	Moiola	330
" ^M	Keaweolu	750	7912 ^C	Liawahine	628	5519 ^C	Moa	331
" ^V	Kapu	751	9919	Laemui	631	5516 ^B	Moa	334
" ^W	Kaleo	752	1989	Lulea	653	3718	Mokaaaloa Iona	353
8164 ^M	Kotikoli	756	2549	Luaihu	711	3721	Mokale	367
7294	Kaelimakule	757	4687	Luwelawe	716	3701	Mokaaonana	381
8497	Kawiwi	758	9990	Lolo	720	1806	Mokaluwawe	391
7055 ^B	Kekauna	758	4685	Luka 2	729	4516	Mohiau	409
7220	Kaukapohua	"	9991	Lolo	754	2526	Mokani	410
7059	Kukahimano	760				3681	Mokapo	439
7010	Kahue	761				4817	Mohoe	440
7098	Kahaia	762				4405 ^F	Mohoe II	444
			3301	Mohoe & Kamakee	4	3012	Mokaweli	448
			2208	Moa	9	4405 ^G	Moa	455
			3020	Mokai	15	" ^R	Moi	457
			10160	Mohoe	23	4708	Mohuka	462
1646	Luahiwa (or Kaluahiwa)	34	1896	Mohana	30	4243 ^D	Mokale	469
1891	Lolo	44	1912	Moa	43	3992	Moa	470
4175 ^B	Luaka	45	10169	Mohoe	44	6148 ^C	Mokapo	501
4683	Leimakani	51	3662	Mohuka	46	" ^L	Moi	506
4682	Lua	52	3667	Mokani	50	3275 ^C	Mokupani	510
3797	Lokomakai	55	4710	Mohula	64	8124 ^B	Moa	527 78 457 74
7485	Luka	59	4810	Moku	74	10223	Moa	527

Index to Volume VIII Award Book

Number	Names	Page	Number	Names	Page	Number	Names	Page
4641	Paele	178	7558 B	Pai	57	11987	Wahinealoha	757
6563	Puana	188	8754 C	Pahupuu	595			
10622	Pai	193	3436 C	Paele	605			
4612	Pala	201	1059 B	Paiu	607			
2397	Puhii	210	7490	Polapohii	614			
2607	Pupaii	214	10521	Puhiale	622			
2609	Poepoo	215	9771	Panaunau	637			
3866	Piimauwaa	264	10692	Paii	653			
246 E	Palu	269	10671	Pepu	655			
64 N	Punee	273	10597	Puou	"			
3	Petero	280	4268 B	Punahoa	660			
3886	Pila	288	3752 B	Pelelu	661			
10650	Pia	303	9453	Papaula	669			
3701 B	Paakauu	312	9514	Palaui	678			
905 C	Piopia	329	9785	Pahua	690			
5459	Pohua	330	1920	Paaluhii	692			
5514	Pohiale	344	1384	Pale	698			
3373	Pu	354	1181: 1183	Pakilo	703			
5515	Pekupuku	359	2020	Pai (no Kaimii w.)	706			
5904	Polea	370	236 L	Pepuku (no Kahalepalaui)	711			
310	Pikamule K.	373	1775	Pawa	713			
3770	Paiii	378	4613	Patupala	715			
1842	Paele	388	4313 B	Paukaa (oriu Maukaa # 10163)	726			
3379	3379 Puaa	395	5216	Penopua	728			
3377	Puulau	399	4620	Pepohii	739			
3374	Pale	401	240 C	Pupuka	753			
5459	Paaluhii	402						
3396	Pilipawahine & Lani	414						
5454	Puanahii	416						
10631	Pahamii	421	11022	Wahinealii	2 * 125			
6564	Papai	435	3277	Waiho	6			
4405 S	Puhii	446	4567	Wahine	84			
3925 A	Pupuaole Puhii	446	6053	Waimaleo S.	98			
10854	Pupuaole	472	10974	Wekelau	118			
6602	Pelua	473	4554	Walanaku	164			
6147 S	Puana	483	4558	Wai	178			
" S	Pahua	496	6517	Waipio	193			
" W	Palaukai	497	4557	Waihowale	201			
" Y	Pai	500	3326	Wahapuu	235			
5341	Poniki	515	10955	Wahimiki	246			
3819: 10646	Puupoo	521	1954	Waiaku	247			
3813	Pahuwai	528	3690 B	Waiaku	268			
6583	Puaa	532	3273	Waiwaiole	345			
2982	Pawale Aiaia	536	2554	Wawae	363			
10733	Pimohu	548	3274	Wanao	415			
10723	Pelapela	552	6148 S	Waiuu	502			
7979	Pinao	553	" S	Wala	"			
7978	Poku	555	4566	Wahineaa	540			
10654	Pueo	560	4271 B	Waiuunatio	659			
7986	Pepuku	563	3135	Walker James	666			
5899	Pupu	567		Wahineaa	696			
10768	Palapala	576	11009	Waiolama	732			
10750	Puki	578	10989	Waiu	759			

		Page
✓ 1629	Kaunohai Oaititi	118
✓ 10974	Wekelu Waialua	348
✓ 9081	Kaupu Kanalei	257 P
✓ 10101	Maalahia Seawater Molokai	480 P
✓ 6445	² Kalahele Kalahele Hawaii	364
✓ 8865	Kaha Wahee Maui	54 P
✓ 3979	Paluani Kaamola Molokai	742

Ke aina o Kahaia ma Keei 2, Kona Hawaii.

E hoomaka ma ke kahi Komohana, a e holo Kona 21° 10' Kik. 7, 70 Kk. ma ke aina Komohiki, Kk. 72° 45' Kik. 7, 50 Kk. ma ke aina Komohiki, Kk. 16' Kom. 7, 80 Kk. ma ke aina Komohiki, Kk. 72° 20' Kom. 8, 75 Kk. ma ke aina Komohiki a hiki i kahi i hoomaka i Moku o keia Apana Aina ke 6 Eka.

Kona Hawaii Aper. 7, 1853

J. Fuller
Lunaanaana

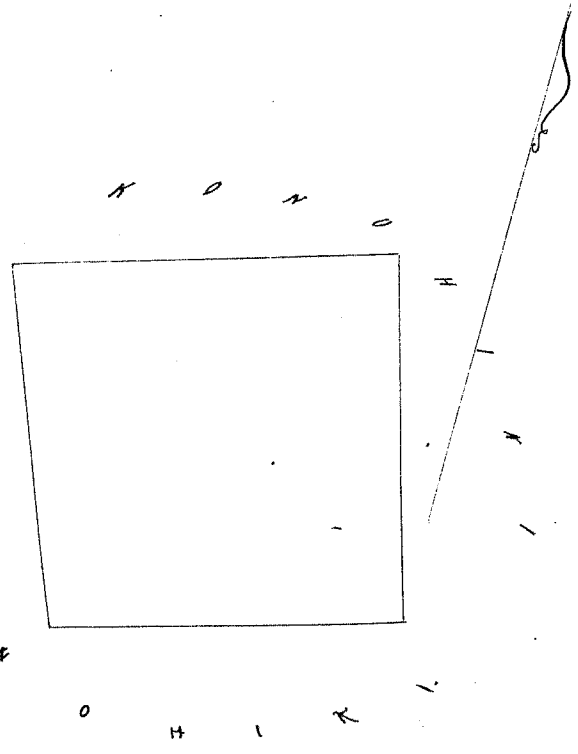

2 Kaulahas - Inika

Ukupaoua

#7

W. L. Lee
G. M. Robertson
J. Kaulahas
J. H. Smith

Honolulu August 23, 1853

Aina ma Kauwala, Kapalama, Oahu.

Ap. 1 Mau Loi. E hoomaka ma ke kahi Kona o keia aina, e pili ana ma ka lili mauka o ke Kahawai, - A e holo Kona 50° 45' Kik. i 116 Panku ana Kona 35° Kom. 295 Panku, e pili ana ma ke aina o ke Komohiki o Kalulu a hiki i Kahawai, - A e holo ma Kahawai i keia Kona 54° Kom. 112 Panku, a malaila a e holo ma ke mawa Kona o ia Kahawai ma ka lili mauka a hiki i ka hoomaka ana. Eia ka Ali 38/100 Eka.

Maraki 28, 1853

J. Kalama
Ana Aina

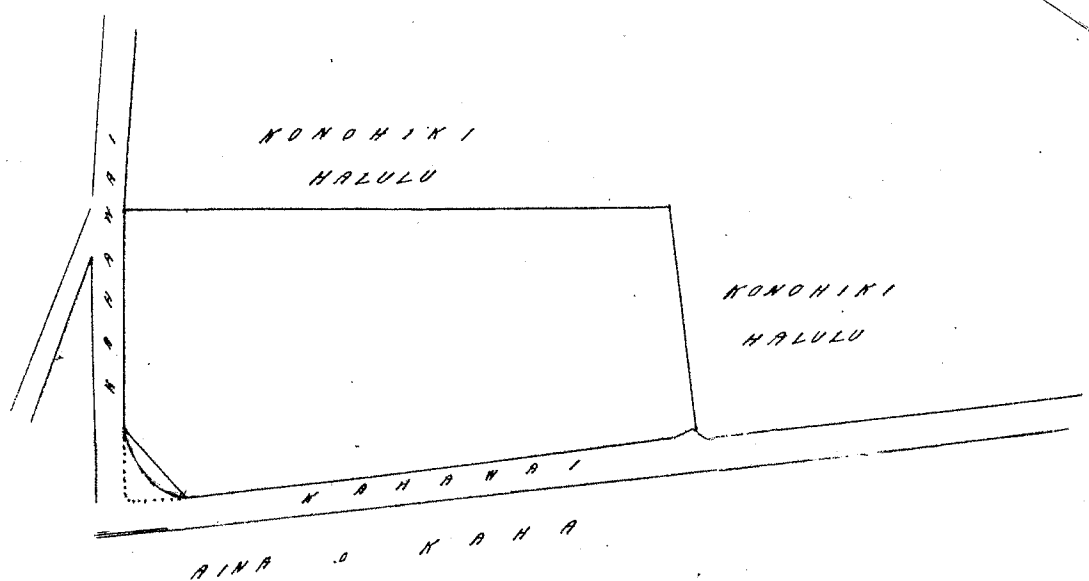

Ukupaoua

#2

W. L. Lee
G. M. Robertson
J. Kaulahas
J. H. Smith

Honolulu December 30, 1853

Index to Volume III Award Book

Number	Names	Page	Number	Names	Page	Number	Names	Page
6667	Maika	543	3921	Nalii	203	1409	Nakoko	704
5743	Manu	540	4758	Nalii	205	3910	Nalaalaau	723
10292	Malale	546	6689	Nakama (or Kuli)	208	10502	Nakou	730
4705	Moopuu	561	3371	Naeu	232	4762	Napela	734
6088	Manumana (no Kapade)	563	4768	Nahiu I.	236	10501	Ninikua	738
10889	Manumuu	569	3366	Naka	240	1084	Nuanu (no Kamama)	762
7277	Maikaiwi	581	3907	Nakala	242		Oni see 1 Page 57	57
8455	Maikole	588	3902	Napahi	259			
6680	Maikoli	617	8146	Nailiha	266			
6105	Maikipora	621	3702	Nawai	312			
9887	Meleai	633	3519	Napohaku	322	460	Pupahoehoe	4
10267	Malowale	642	3886	Napela	333	2980	Pakele	12
10270	Mauiou	643	5516	Naopu (or Opu)	335	2199	Pahou	22
10252	Mauiw	648	4562	Namokulua	350	1882	Paalea	26
1769	Malaihi	657	10469	Napoe	355	1649	Pupuawa	2
2008	Malailua (no Kaumama)	665	5521	Nakaikuaana	375	2619	Pahaw	29 vs 1000
9507	Maikowai	670	5439	Naele	405	10623	Pakui	33
974	Moo Boaza	686	3327	Naialaolao	414	1885	Panawa	43
1294	Manu	689	5501	Nalwahi	417	4821	Paipaiku	48
10106	Maikole	695	3336	Nalopi	418	5218	Penopeno	59
10107	Maunaloa	722	3528	Naopu	421	7617	Puha	60
5011	Maikaulaau	737	2572	Nahana	431	4610	Pule	62
6665	Maahi	744	4818	Namaile	436	6560	Pouahi	66
240	Manoha	753	3924	Nakupala	464	3841	Pakaka	68
			3931	Naiwimawaho	465	3818	Paloku	"
			6147	Napuunoo	488	6569	Paaku	73
			6148	Nahalea	501	4613	Palapala	"
			"	Nahoa	507	5328	Pupuka	80
10481	Napailoi	11	10312: 9134	Namaileua	514	5279	Palikai	81
3343	Nikeu	12	2660: 10313	Namaui O.	521	10639	Pa	87
3340	Nahau	17	10691	Naiwi + Punonea	523	10883	Pahuama	92
3337	Naanaa	19	5181	Nawaimakaha	537	5332	Pule	94
10460	Nalii	19	26	Nahelu	538	10816	Pohano	101
1446	Naa	32	10369	Ninawaiwi	547	3868	Pila	102
10545	Nahale	39	10888	Nakakou	569	2741	Puo	112
6634	Nahoiha	56	10327	Nahuina	583	2726	Puakalihi (no K)	113
6636	Nauue	57	3936	Nakahili	586	10727	Paele	117
4757	Napoka	62	8754	Nanoaina	594	2743	Pilipi	118
3826	Nalu	65	9212	Nailiha	601	4670	Puau	136
3913	Nao	69	10986	Nawelu	605	2965	Puhi	146
3912	Nakaula	70	9414	Naai	609	6592	Puana	147
4755	Naai	72	10319	Nahina	618	5127	Pikomui	151
10482	Naha	76	10526	Naw	632	10628	Puhi	154
7971	Nauliuli	93	5692	Naiwiakolea	638	1989	Puali	158
6824: 10030	Napuulu	99	1446	Naa	639	10689	Pukuakahi	161
2749	Nakahihale	107	9944	Nalima	645	10660	Pakaa	"
2748	Nachuelua	109	10322	Nalima Nahi	649	4640	Puaa	165
10482	Naha	124	4273	Nakaluna	658	4611	Pohaku	169
10907	Nammiumi	155	7283	Napuawa	662	4656	Puoa	"
10473	Nahi	156	"	Nawaihu	669	4636	Puakauwala	172
10326	Naneataa	180	9745	Naili	678	2597	Puola	"
6635	Naholowaa	182	"	Namaulike	685	4625	Pohina	173
6630	Nakalina	191	1999	Nalimu	697	3414	Puauhi	175

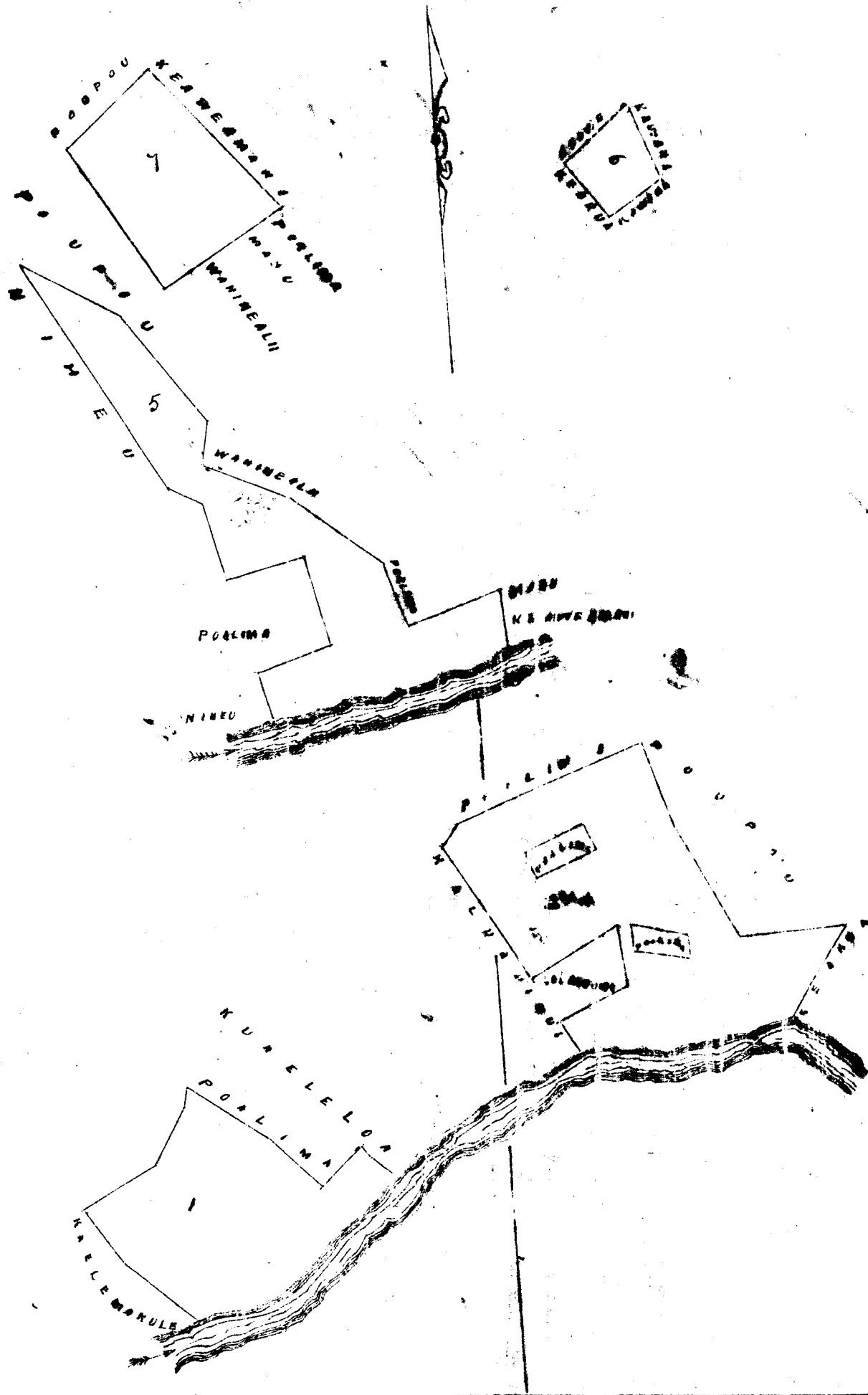

Uku Tau Loa 74.

Wahine
 G. M. Robertson
 J. Kakaualaha
 C. H. Smith

Honolulu June 25 1852

Lot 1022 Wahinealii Waikapu Maui

Keleka 11222 no Wahinealii Waikapu Maui
 Apana 1 ili, Palama 8 hoomaka ma ke kiki Ahau via ke kiki Hema. Loaloe a e holo ke 35 ke 36
 ke pili ana me A Catalina ke 30 ke 41 Ah e pili ana me A Catalina ke 60 1/2 ke 78 Ah e pili ana me
 ke Palama ke 32 1/2 ke 45 Ah e pili ana me ke Poalina Ah 51 ke 75 Ah e pili ana me ke Poalina
 ke 20 ke 141 Ah e pili ana me A Catalina ke 17 ke 68 Ah e pili ana me ke A Catalina ke 74 ke 83 Ah
 pili ana me ke Kahawai Ah 27 ke 547 Ah e pili ana me ke Haina Ah 30 ke 82 Ah e pili
 ana me ke Kula Ah 56 1/2 ke 56 Ah e pili ana me ke Kula a e holo i hoomaka ke 7 1/2 Eka
 Apana 27 e. Mahale 1 ili o Palama 8 hoomaka ma ke kiki Ahau e pili ana me ke Kula a e holo
 ke 34 1/2 ke 419 Ah e pili ana me Haina ke 54 1/2 ke 77 Ah e pili ana me ke Poalina ke 32 1/2 ke 57 Ah
 pili ana me ke Poalina Ah 62 ke 100 Ah e pili ana me ke Poalina ke 8 ke 124 Ah e pili
 ana me Haina ke 31 1/2 ke 43 Ah ma ke Poalina ke 58 1/2 ke 78 Ah ma ke Poalina Ah 33 1/2 ke 46 Ah
 ma ke Poalina ke 56 ke 111 Ah ma ke Poalina ke 44 1/2 ke 57 Ah ma ke Poalina ke 44 1/2 ke 42 Ah
 ma ke Poalina Ah 45 ke 73 Ah ma ke Poalina ke 48 1/2 ke 56 Ah ma ke Poalina Ah 43 1/2 ke 44 Ah
 ma ke Keawamahi Ah 18 1/2 ke 134 Ah ma ke Keawamahi Ah 31 1/2 ke 302 Ah ma ke Keawamahi
 ke 47 ke 115 Ah ma ke Keawamahi Ah 54 ke 274 Ah ke Kula Aupuni 1 1/2 Eka
 Apana 27 e Mahale 1 hoomaka ma ke Kahawai kiki Hema a e holo Ah 30
 ke 267 Ah e pili ana me ke Kahawai ke 40 ke 116 Ah ma ke Poalina Ah 44 ke 25 Ah
 pili ana me ke Poalina ke 49 1/2 ke 80 Ah e pili ana me ke Poalina ke 48 ke 86 Ah
 pili ana me ke Keawamahi i ke hoomaka ma ke Kakaualaha

Apana 243 Mahale 2 ili o Palama i hōmaka ma te Kihī Akau e pili ana me te Kōwhiri a e hō
 He 47½ He 373 Kk e pili ana me te Kōwhiri He 47½ He 71 Kk e pili ana me te Kōwhiri He 57½ He 111 Kk
 e pili ana me te Kōwhiri He 111 He 373 Kk e pili ana me te Kōwhiri He 47½ He 627 Kk e pili ana
 me te Kōwhiri He 373 He 202 Kk e pili ana i te Kōwhiri me te Kōwhiri i hōmaka i hōmaka
 1 $\frac{58}{100}$ Eka,

Apana 4 ili o Palama i hōmaka ma te Kihī Akau e pili ana me te Kōwhiri a e hō
 He 21½ He 74 Kk e pili ana me te Kōwhiri He 21½ He 253 Kk e pili ana me te Kōwhiri He 48½ He 111 Kk
 ma te Kōwhiri He 21½ He 144 Kk e pili ana me te Kōwhiri He 70½ He 12 Kk e pili ana me te Kōwhiri
 He 22½ He 103 Kk e pili ana me te Kōwhiri He 71½ He 46 Kk e pili ana me te Kōwhiri He 57½ He 111
 Kk e pili ana me te Kōwhiri He 67½ He 111 Kk e pili ana me te Kōwhiri He 9 He 15 Kk e pili ana
 me te Kōwhiri He 67½ He 57 Kk e pili ana me te Kōwhiri He 57 He 38 Kk e pili ana me te Kōwhiri
 He 60½ He 96 Kk e pili ana me te Kōwhiri i hōmaka i hōmaka i hōmaka i hōmaka
 1 $\frac{9}{100}$ Eka,

Apana 8 Pahale 8 ili o Palama i hōmaka ma te Kihī Akau e pili ana me te Kōwhiri a e hō
 He 62 He 23 Kk e pili ana me te Kōwhiri He 11½ He 237 Kk e pili ana me te Kōwhiri
 He 67½ He 216 Kk e pili ana me te Kōwhiri He 23 He 257 Kk e pili ana me te Kōwhiri
 me te Kōwhiri i hōmaka i hōmaka i hōmaka i hōmaka

E Bailey

Mea ana aina

April 16 1852

N. B. He mau Pelema ma Apana 5, 6 & 7

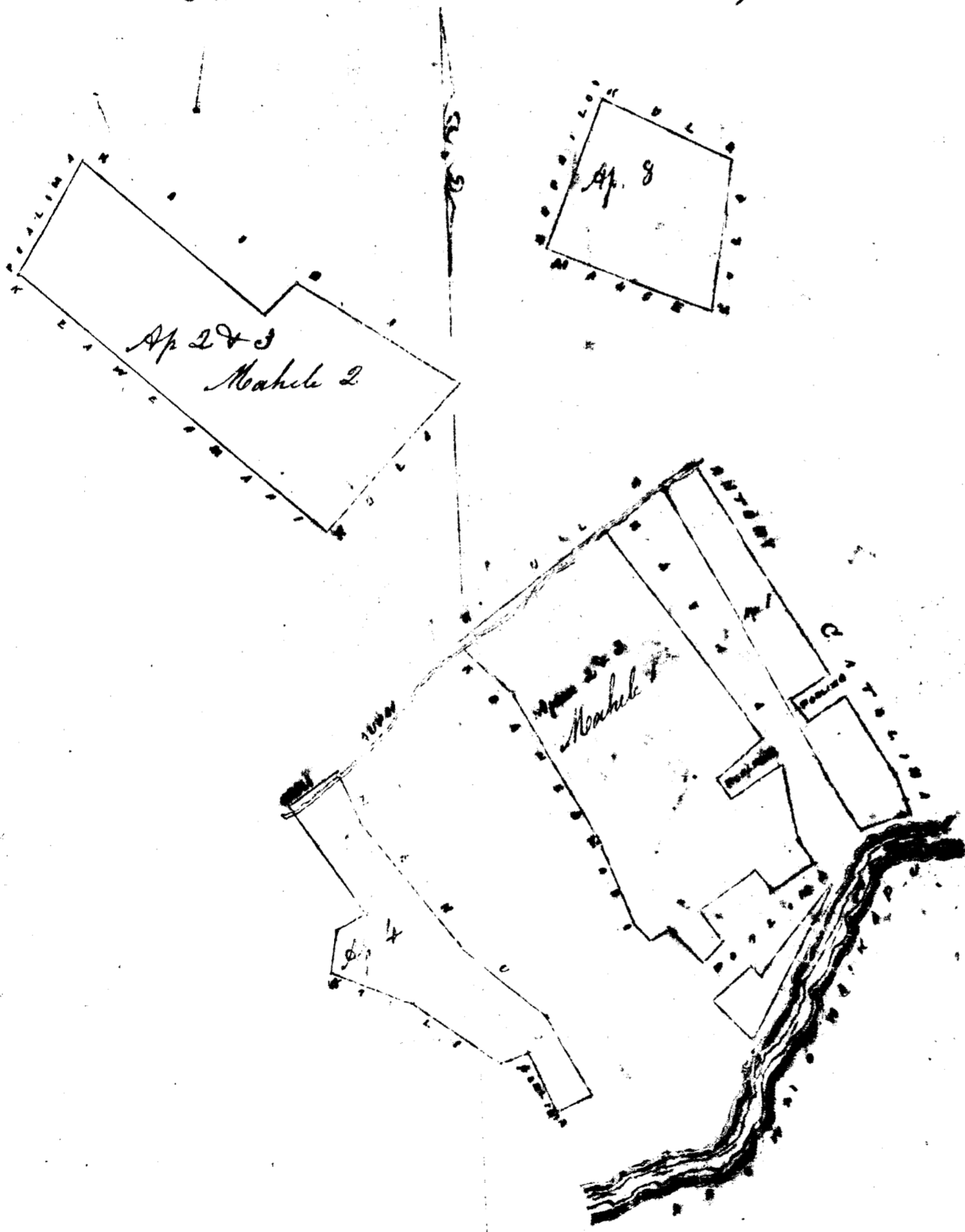

48
 7
 80
 1.58
 67
 5.23
 60
 5.83

Ulu Loo Loo 77

W. H. Robertson
 J. H. Robertson
 J. H. Smith

Keolu 3304 Mahoe & Hamakua Waikapu Maui

Hamakua 3304 no Mahoe & Hamakua ili o Olohe Waikapu Maui
 Apana i E homaka ke ana ma ke kumu Miliwili kiki kuma ana ka pali a e holo AK 72° Ni
 400 Ah e pili ana i ke kahawai AK 45° Ni 100 Ah e pili ana i ke kahawai AK 25° Ni 76 Ah
 e pili ana me Pakela AK 34° Ni 55 Ah e pili ana me ka Poalima AK 48° Ni 120 Ah e
 pili ana me ka Poalima Ke 37½ Ni 58 Ah e pili ana me ka Poalima AK 45 Ni 313 Ah
 e pili ana me ke Pakela AK 19½ Ni 123 Ah e pili ana me ke Pipinui AK 37½ Ni 756 Ah
 e pili ana me ke Pipinui Ke 73 Ni 718 Ah e pili ana me ka Pali AK 15½ Ni 756 Ah e pili
 ana me Haleole Ke 28° Ni 427 Ah e pili ana me ke Pipinui me Kapaiti i Kahi i homaka
 ni 9. ⁷/₁₀₀ Eka

Ua haalele laua i ka Apana 2

I oi Aupuni mai ke kiki ma ke ala ma ka wai Hamakua e ana ke
 AK 59° Ni 226 Ah i ke kiki ma alaila holo AK 57½ Ni 200 Ah AK 32½ Ni 30 Ah
 Ke 57½ Ni 200 Ah Ke 32½ Ni 70 Ah i Kahi i homaka: 1 ⁷/₁₀ Naulakaa

April 27 1852

G. Bailey
 Heo ana aina

9.07
 4/6
 9/67

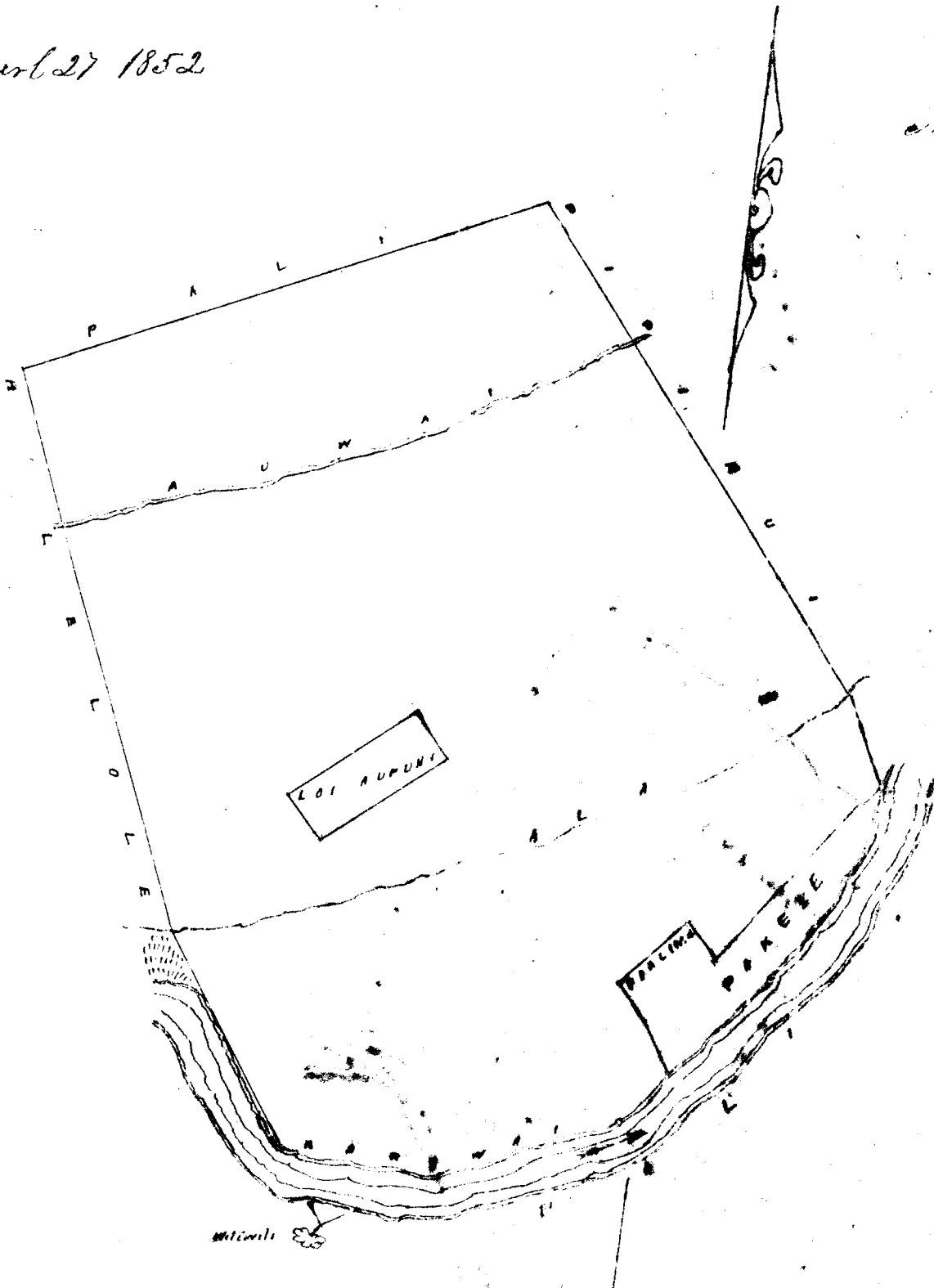

Uku Pau Loa 10.

M. M. K.
 G. M. Robertson
 J. K. Kaulahao
 J. H. Smith

Honolulu June 25 1852

Keolu 460 Poupahoe Waikapu Maui

Pulapala no ke ana ana i ke Kuleana 460 no Poupahoe ma ka ili o Pihipili Waikapu
 mo Kapeuni o Maui
 Apana i E homaka i ke ana ma ke kiki Akau o keia e pili ana me ke Kulekai
 Kulekai a me Kulekai a me holo AK 75½ Ni 755 Ah ma ke Kulekai AK 32½ Ni 40
 Ah ma ke Poupahoe AK 20 Ni 200 Ah e pili ana me ke Poupahoe AK 10 Ni 100 Ah ma
 ke Kulekai AK 20 Ni 200 Ah ma ke ili o Pihipili Waikapu ma ka kahawai
 AK 20 Ni 200 Ah ma ka Kulekai AK 20 Ni 200 Ah ma ke ili o Pihipili Waikapu
 AK 20 Ni 200 Ah ma ke Kulekai AK 20 Ni 200 Ah ma ke ili o Pihipili Waikapu

He 28 1/2° Ni 51 Kk e pili ana me ka Poalima Ak 31° Ni 84 Kk e pili ana me ka Poalima Ak 31°
 Ni 94 Kk e pili ana me ka Wakimaele He 45 1/2° Ni 63 Kk e pili ana me ka Wakimaele He 48° Ni 18
 Kk e pili ana me ka Poalima He 38 1/2° Ni 47 Kk e pili ana me ka Poalima Ak 46 1/2° Ni 80
 Kk e pili ana me ka Poalima He 43 1/2° Ni 151 Kk e pili ana i ka Poalima & Wakimaele
 He 25 1/2° Ni 125 Kk e pili ana me ka Mahawai He 76 1/2° Ni 164 Kk e pili ana me ka Mahawai
 Ak 6 1/2° Ni 38 Kk e pili ana me ka Kaili Ak 63 1/4° Ni 90 Kk e pili ana me ka Moani Ak 8 1/2°
 Ni 102 Kk e pili ana me ka Moani Ak 37° (116 Kk) e pili ana me ka Poalima Ak 39 1/2° Ni 147
 Kk e pili ana me ka Moani Ak 32 1/2° Ni 189 Kk e pili ana me ka Moani Ak 40 1/2° Ni 90 Kk
 e pili ana me ka Poalima Ak 42° Ni 66 Kk e pili ana me ka Kaili & Poupou Ak 57° Ni 112
 Kk e pili ana me ka Kaili & Poupou Ak 39 1/2° Ni 57 Kk & Ak 57 1/2° Ni 69 Kk me ka Poalima
 Ak 80 1/2° Ni 126 Kk me ka Poalima akai Ak 18° Ni 67 Kk & Ak 56 1/2° Ni 83 Kk me ka
 Heaka a pumi 2 2/100 Eka

April 16, 1852

E. Bailey
Me ana aina

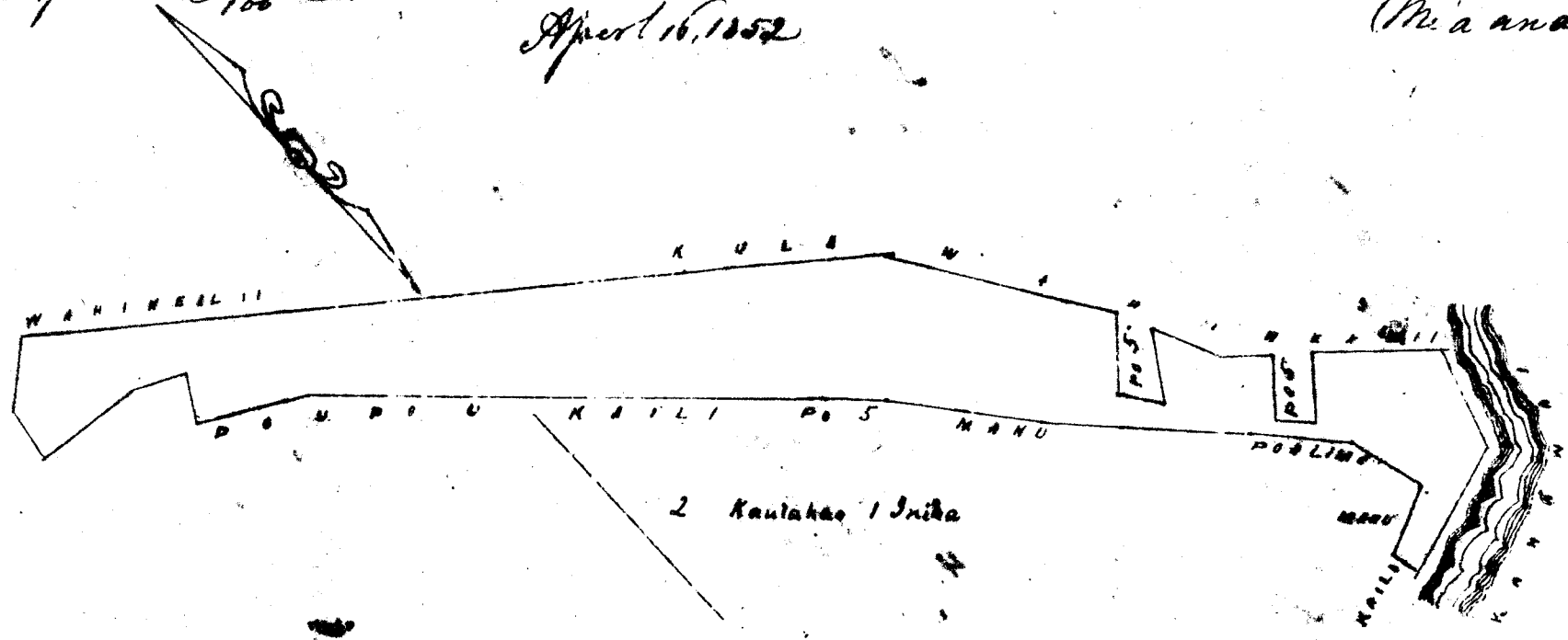

Ulu Pau Loa #6.
 H.H.L.
 G. M. Robertson
 J. Kaulahe
 J. H. Smith

Honolulu June 25 1852

Hele 3/04 Kaulahe

Waikapu Maui

Palapala o ke ana ana i ke Kaulahe 3104 me ka Kaulahe ma ka Kaili o Chio Waikapu Motupuni
 Moani e hoonaka ma ke Kaili Kaulahe. Heia e pili ana me ka Kaulahe me ka Mahawai a e holo Ak 44°
 Ni 141 Kk ma ka Kaili Ak 36° Ni 39 Kk ma ka Kaili & Kaulahe a ke he 91 Kk wale me a hiki
 ke Kaili o ka Poalima Ak 27° Ni 568 Kk ma ka Kaulahe Ak 45° Ni 429 Kk ma ka Kaulahe
 & Aupuni He 33° Ni 80 Kk ma ka Aupuni a hiki ma ka Moani He 34 1/2° Ni 797 Kk ma ka Moani
 o ka Kaulahe He 14° Ni 90 Kk a hiki i ka Moani He 26 1/2° Ni 173 Kk ma ka Moani He 38 1/2°
 Ni 265 Kk ma ka Moani a hiki i ka Mahawai Ak 15 1/2° Ni 220 Kk ma ka Mahawai a hiki
 Ni ma Kahi i hoonaka i o maalohe oia anapuni 1 83/100 Eka

1.83
16
7.67

Poalima via Kaulahe - ua hui ai aku hui mai ua hui ia ma Kahi hiki hiki Eka
 onaka e hiki me luna oia a e holo Ak 36° Ni 89 Kk ma ka Poalima o Kaulahe He 50° Ni 189 Kk
 ma ka Kaulahe He 38 1/2° Ni 88 Kk ma ka Moani Ak 49 1/2° Ni 183 Kk ma ka Kaulahe
 a hiki ma Kahi i hoonaka i o maalohe oia anapuni 1/50 o ka Eka

E. Bailey
Me ana aina



Uku paau loa 15.

W. H. Keen
G. M. Robertson
J. H. Kaulahao
J. H. Smith

Honolulu June 25 1852

Heleu 8808 Heheliiaiku

Waikapu Maui

Pulapala ou ke ana ana i ke Heleuana 8808 no Heheliiaiku ma ka ili. Matakulaha Waikapu
Maui

Ke hoomaka i ke ana, ma Apana 1, 2 a me 4 i hui ia i hookahi ma ke Kiki Komohana
Apana e pili ana me Puupahohoe Maunuku & Nanihi a e holo Ak 7° Ni 339 Kh ma ka palena
Kahuahi Ak 14 1/2 Ni 204 ma ka palena o Nanihi me Puupahohoe Ak 7 1/2 Ni 358 Kh ma ke
Kehukua (w) Ak 9 1/2 Ni 56 Kh ma ke Kukulua (w) Ak 6 1/2 Ni 136 Kh ma ke Kukulua (e)
Ak 18 1/2 Ni 168 Kh ma ke Kukulua (e) a i ke S. Richardson, Ak 7 1/2 Ni 508 ma ke S.
Richardson a i ke Puupahi Ak 3 1/2 Ni 702 Kh ma ke Puupahi a i ke Puupahohoe
Ak 16 1/2 Ni 555 Kh ma ke Puupahohoe a hiki i Kahi i hoomaka i a maloko ia ana
puni 5 1/2 Eka.

Apana 3. Ke hoomaka i ke ana ma ke Kahawai i ke Kiki Nihina Nema e pili ana me
Kaa a e holo Ak 5 1/4 Ni 490 Kh ma ka palena o Kaa i ka auwai Ak 7 1/4 Ni 398 Kh
ma ke Koniha & Maunuku Ak 7 1/4 Ni 332 ma ke Kulaia Ak 23° Ni 210 Kh ma ke
Kaa Ak 7 1/2 Ni 60 Kh ma ke Eka Ak 23 1/2 Ni 123 Kh ma ke Eka Ak 6 1/2 Ni 70 Kh ma
ke Eka Ak 8 1/2 Ni 61 ma ke Eka Ak 4 1/2 Ni 131 Kh ma ke Eka a hiki i Kahawai
Ak 7 1/2 Ni 80 Kh ma ke Kahawai Ak 7 1/2 Ni 136 Kh ma Kahawai a hiki ma Kahi i hoo-
maka i a maloko ia anapuni 1 9/100 Eka

E. Bailey
Ke ana ana

5.50
1.96
7.46

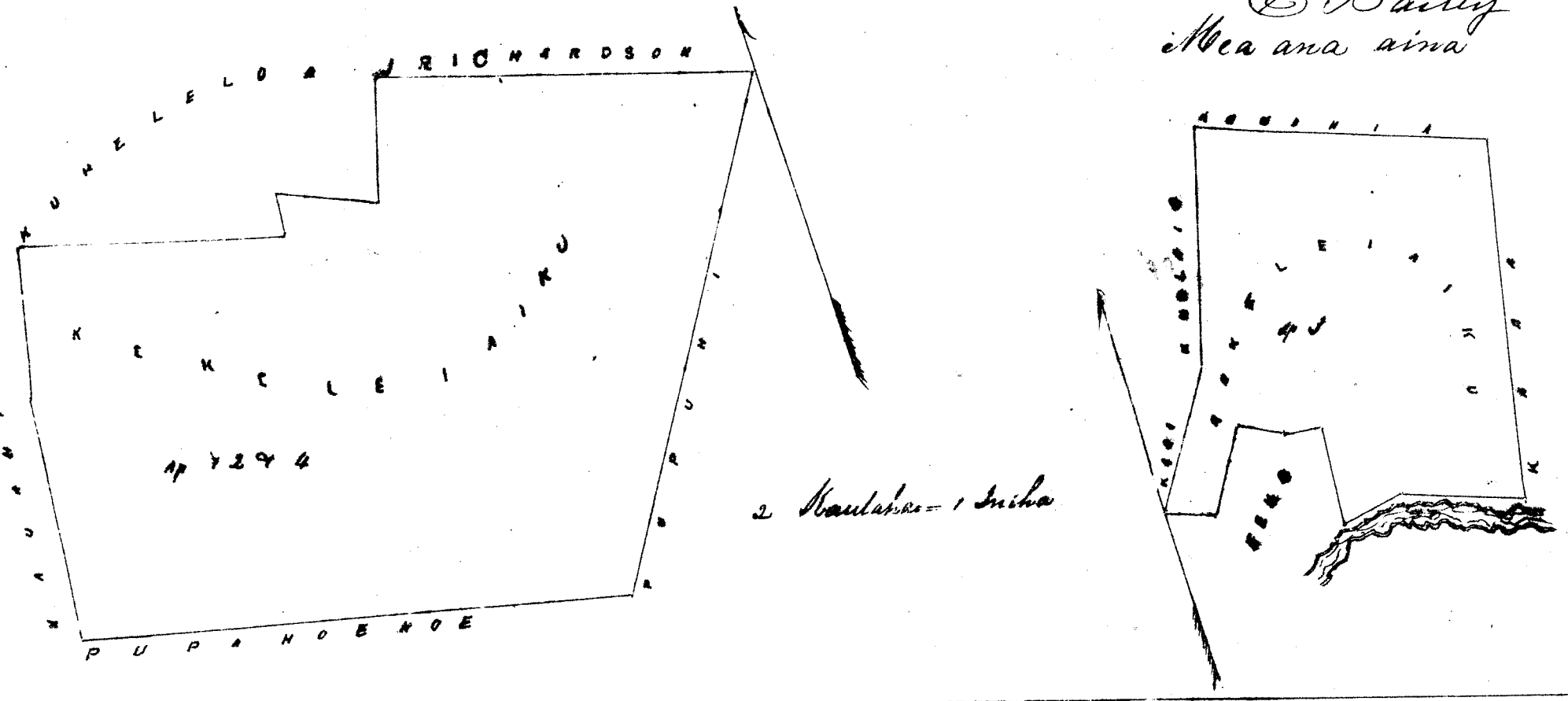

Uku Paau Loa 18.

W. H. Keen
G. M. Robertson
J. H. Kaulahao
J. H. Smith

Honolulu June 25 1852

Heleu 5742 Kahuahinui

Waikapu Maui

Heleuana 5742 no Kahuahinui Waikapu Maui
Apana 1 Mahute i Ili. Ohia Ke hoomaka ma ke Kiki Akau e pili ana me ke Nahuana
Heleuana a e holo Ak 57 1/2 Ni 200 Kh e pili ana me ke Nahuana Ak 56° Ni 122 Kh
ma ke Nahuana Ak 23 1/4 Ni 60 e pili ana me ke Nahuana Ak 72 1/4 Ni 56 Kh ma ke
Nahuana Ak 29 1/2 Ni 383 Kh ma ke Nahuana Ak 55° Ni 81 Kh ma ka Palima
Ak 35 1/4 Ni 444 ma ke Palima Ak 57° Ni 444 Kh ma ka Palima Ak 40°
Ni 532 Kh

A hiki ma kahi i hoomaka i $\frac{72}{100}$ Eka
 Apana 1 Mahale 2 E hoomaka ma ke kahi Akau e pili ana me ka Poalima
 a me Kaili a e holo $AK 32^{\circ}$ $Hi 208$ Kh e pili ana me ke Kaili $AK 42^{\circ}$ $Hi 140$ Kh e pili
 ana me ka Poalima $AK 34^{\circ}$ $Hi 59$ e pili ana me ka Poalima $AK 61^{\circ}$ $Hi 136$ Kh ma
 ka Poalima $AK 62^{\circ}$ $Hi 60$ Kh e pili ana me ke Kaili $AK 61^{\circ}$ $Hi 146$ Kh ma ke Kaili
 $AK 30^{\circ}$ $Hi 121$ Kh ma ke Kihuhiloa $AK 38^{\circ}$ $Hi 222$ Kh ma ke Manu $AK 57^{\circ}$
 $Hi 162$ Kh ma ka Poalima i kahi i hoomaka i $\frac{51}{100}$ Eka

Apana 2 ili o Puhau Palama E hoomaka ma ke kahi Akau e pili ana
 me Keawamahi a e holo $AK 55^{\circ}$ $Hi 82$ Kh ma - Poupou $AK 57^{\circ}$ $Hi 126$ Kh
 $AK 42^{\circ}$ $Hi 65$ Kh e holo $AK 56^{\circ}$ $Hi 177$ Kh ma ke Keaka $AK 18^{\circ}$ $Hi 67$ Kh ma ke Keawamahi
 a hiki ma kahi i hoomaka i $\frac{12}{100}$ Eka

J. Bailey
 Mea ana aina

April 28, 1852

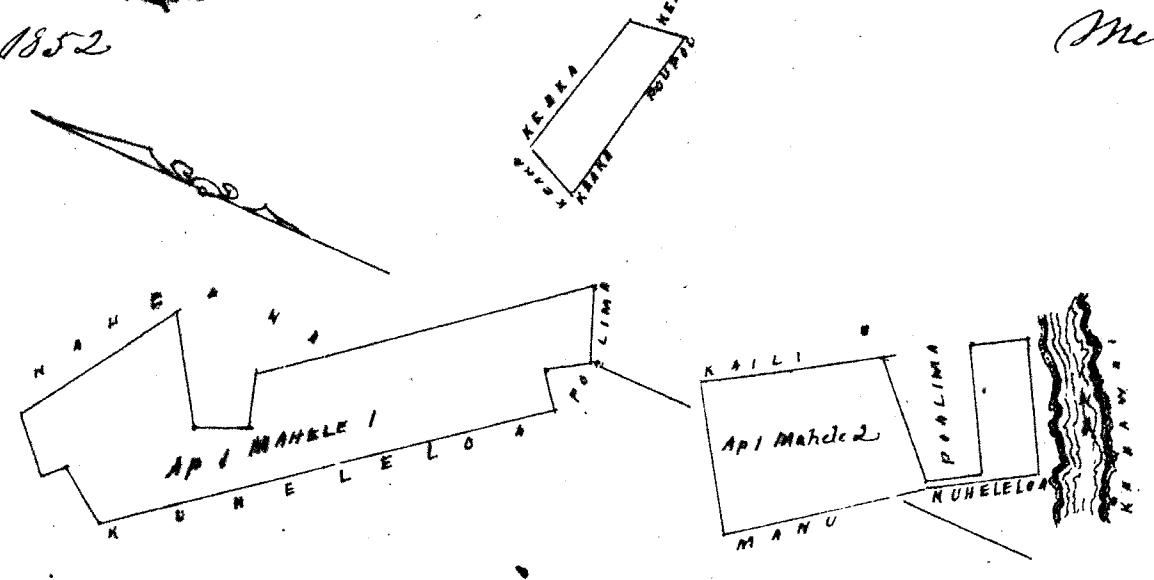

72
 36
 12
 1.20

Whiu Pau Loa 17
 W. M. Robertson
 J. Kakaialapa
 J. H. Smith

Honolulu June 25 1852

Hele 2208 Manu

Waikapu Maui

Palapala me ke ana ana i ke Kuleana 2208 me Manu me Waikapu Maui - a, kekahi
 hapa hapa ia Kuleana me kekahi hapa, ke Kuleana 446 me Akapau ka mea i mahele
 a o Manu ka hoilina

Apana 1 ma ka ili o Palama E hoomaka i ke ana ma ke kahi Komohana Akau o Keia
 e pili ana me ka pahale, Kaili a e holo $AK 57^{\circ}$ $Hi 37$ Kh ma ka Poalima, Kaili i Poupou
 $AK 52^{\circ}$ $Hi 87$ Kh ma ka Poalima $AK 59^{\circ}$ $Hi 97$ Kh ma ka Poalima $AK 33^{\circ}$ $Hi 189-78$ Kh ma
 ma ke Keawamahi i kekahi Poalima $AK 51^{\circ}$ $Hi 100$ Kh ma ka Poalima $AK 39^{\circ}$ $Hi 64$ Kh ma
 ka Poalima $AK 58^{\circ}$ $Hi 93$ Kh ma ka Poalima $AK 39^{\circ}$ $Hi 249$ Kh ma ke Keawamahi
 a i kekahi Poalima $AK 47^{\circ}$ $Hi 55$ Kh ma ka Poalima $AK 34^{\circ}$ $Hi 113$ Kh ma ka Poalima
 ma $AK 53^{\circ}$ $Hi 60$ Kh ma ka Poalima $AK 8^{\circ}$ $Hi 102$ Kh ma ke Keawamahi $AK 68^{\circ}$ $Hi 50$ Kh
 ma ke Keawamahi a i ke Kaili $AK 61^{\circ}$ $Hi 53$ Kh ma ke Kaili $AK 70^{\circ}$ $Hi 39$ ma ke Kaili
 i ke Mahinaihi $AK 36^{\circ}$ $Hi 144$ Kh ma ke Mahinaihi $AK 48^{\circ}$ $Hi 177$ Kh ma ke Mahinaihi
 $AK 36^{\circ}$ $Hi 255$ Kh ma ke Mahinaihi $AK 31^{\circ}$ $Hi 94$ Kh ma ke Mahinaihi a hiki ma kahi i
 hoomaka i mahele ia anapuni $\frac{72}{100}$ o ka Eka

Palama
 72

Ohia
 18

16
 150

Ua haule ma Apana 2 & 4 - he kili loa aha e ana ia ke Koi ma o Manu la
 Apana 3, ma ka ili o Ohia E hoomaka ma ke kahi Komohana e pili ana me ke Kihuhiloa
 a e holo $AK 86^{\circ}$ $Hi 46$ Kh ma ka Poalima, o ka Poalima $AK 38^{\circ}$ $Hi 222$ Kh ma ke Kaili
 ma $AK 66^{\circ}$ $Hi 47$ Kh ma ke Kihuhiloa, $AK 36^{\circ}$ $Hi 243$ ma ke Kihuhiloa a hiki ma kahi i
 hoomaka i a mahele ia anapuni, Kaulahao

Kuleana 446 Apana, ma Ohia E hoomaka ke ana ma ka pali Kihuhiloa Akau
 o Keia e pili ana me ke Pipinui a e holo $AK 73^{\circ}$ $Hi 116$ Kh ma ka pali a hiki
 ke Kaulamakule $AK 34^{\circ}$ $Hi 797$ Kh ma ka Poalima, Kaulamakule, $AK 1^{\circ}$ $Hi 90$ Kh
 ma ke Kaulamakule a i ke Mounuku $AK 73^{\circ}$ $Hi 86$ Kh ma ke Mounuku $AK 31^{\circ}$ $Hi 910$ Kh
 ma ke Pipinui a hiki ma kahi i hoomaka i mahele ia anapuni Kaulahao Eka

J. Bailey
 Mea ana aina

May 1852

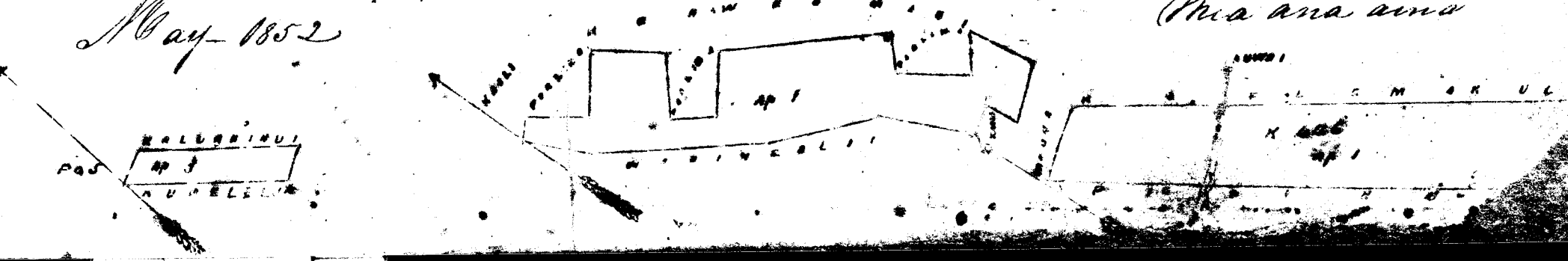

W. H. W.
G. M. Robertson
J. T. Kaulahao
J. H. Smith

Honolulu June 25 1852

Hulu 10481 Napailoi (((

Waikapu Maui

Kuleana 10481 no Napailoi Waikapu Maui

Apana 1 Mahale 1 ili o Paalae & hoomaka ma ke kahi hikina & pili ana me Mahimalii a e
He 23° No 170 Kh e pili ana me ke Mahimalii He 58° No 84 Kh e pili ana me ke Kula He 11°
314 Kh e pili ana me ke Kula He 71 1/2° No 202 Kh e pili ana me ke Kula He 11 1/2° No 19
ma ke Kula a hiki ma kahi i hoomaka i - 54/100 Eka

54
19
10
1 23
66
22
274

Apana 1 Mahale 2 ili o Paalae & hoomaka ma ke kahi hikina ma kahi i hoomaka
a e holo He 26 3/4° No 96 Kh e pili ana me ke Kula He 58° No 235 e pili ana me ke Kula
He 20 1/4° No 66 Kh e pili ana me ke Kula He 65 1/4° No 242 Kh e pili ana me ke Kula a e hiki
i hoomaka i - 19/100 Eka

363

Apana 1 Mahale 3 ili o Paalae ma ke kahi hema o ka mahale 2 e ana He 69 1/2°
Kh i ke kahi mua - He 9 3/4° No 115 Kh e pili ana me ke Kula He 55 1/2° No 96 Kh e pili ana
me ke Kula He 17 1/2° No 112 Kh e pili ana me ke Kula He 88 1/2° No 81 Kh e pili ana me ke Kula
i kahi i hoomaka i - 1/100 Eka

Apana 2 & 3 ili o Waipahulu & hoomaka i ka Maui hoomaka a e holo He 83 1/4° No 168 Kh
e pili ana me ke Kula onalo He 17 1/2° No 304 Kh e pili ana me ke Kula onalo He 14 1/2° No 315
Kh e pili ana me ke Kula onalo He 85° No 124 Kh e pili ana me ke Kaupali He 4° No 624 Kh
e pili ana me ke Kula onalo i kahi i hoomaka i - 1 3/100 Eka

Apana 4 ma ke Kuai ana me kekahi kua ma ke ili o Kaloala & hoomaka ma ke
hawaii kahi i kaale ai ka wai i ka pali kahi ma kahi o keia apana a e holo He 12° No 11
Kh e pili ana me ke Kahawai He 74° No 74 Kh e pili ana me ke Opunui He 55 1/2° No 5
e pili ana me ke Opunui He 15° No 161 Kh e pili ana me ke Opunui He 28° No 160 Kh
e pili ana i ke Kahawai He 66° No 437 Kh e pili ana me ka pali a kahi i hoomaka i - 56/100 Eka

Apana 5 ili o Kaopala & hoomaka ma ke Kahawai kahi Maui e pili ana me Waikoa
a e holo He 20° No 286 Kh e pili ana me Waikoa He 56 1/2° No 88 Kh e pili ana me Kahuhui
He 23° No 221 Kh e pili ana me Kahuhui He 79 1/2° No 90 Kh e pili ana i ke Kahawai
kahi i hoomaka i - 22/100 Eka

April 23 1852

C. Bailey
Mea ana aina

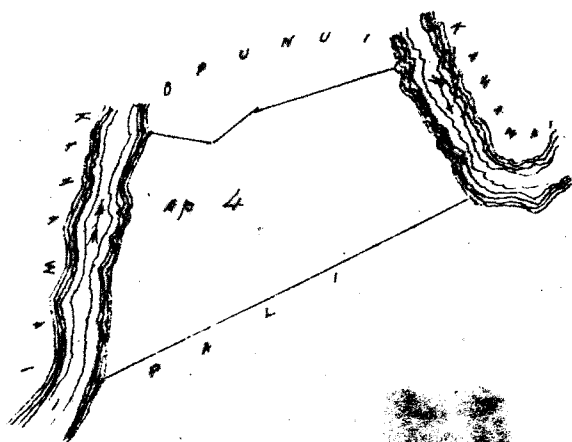
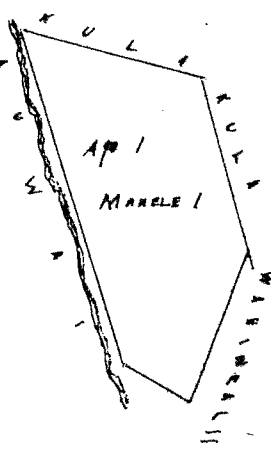
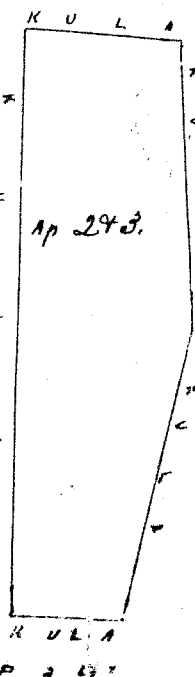
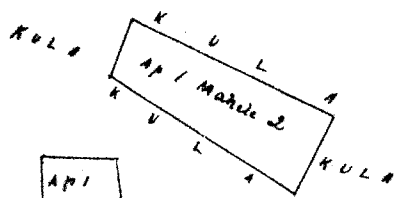

Uku Tau Ioa #6.

W. H. H. H.
G. M. Robertson
J. K. Kaulahao
J. H. Smith

Honolulu June 25 1852

Heleu 2980 Takele I

Waikapu Maui

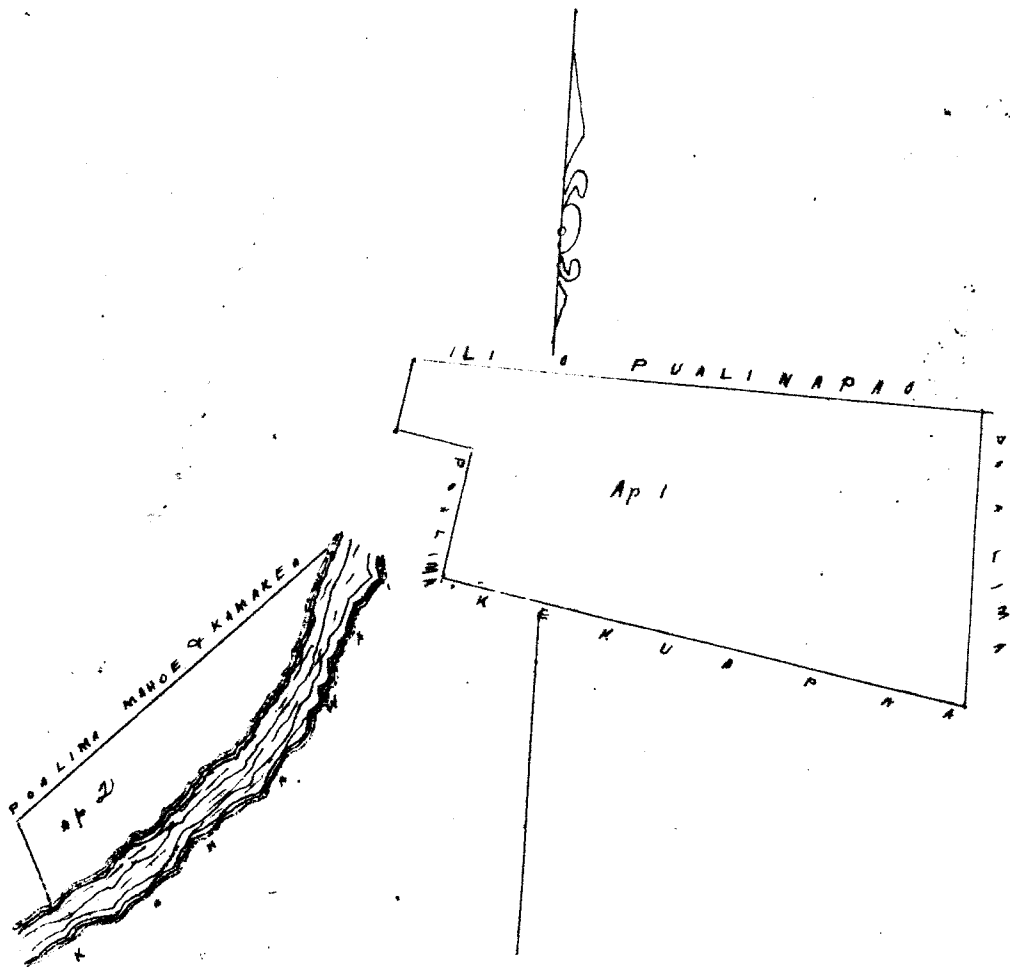

Heleuana 2980 mo Takele Waikapu Maui

Ahana 1 ili. Kaiaa i hoomaka ma ke kahi Komohana Akau e pili ana me ka ili o Pualinapao a i holo He 87 1/2 Ni 511 Kk e pili ana me ka ili o Pualinapao He 3 1/2 Ni 512 Kk e pili ana me ka Poalima He 78 1/2 Ni 572 Kk e pili ana me Kekuapaa He 9 1/2 Ni 144 Kk e pili ana me ka Poalima He 83 1/2 Ni 82 Kk e pili ana me ka Poalima He 1 1/2 Ni 75 Kk e pili ana me ka ili o Pili-pili i Kahi i hoomaka i 1 56/100 Ika.

Ahana 2 ili o Cloke i hoomaka ma ke kahi Komohana oia ke kahi He. Ka Poalima a i holo He 48 Ni 123 Kk e pili ana me ka Poalima He 45 Ni 313 Kk e pili ana me Kamaheka ma He 32 1/2 Ni 170 Kk e pili ana me ke Kahawai He 45 Ni 300 Kk e pili ana i ke Kahawai He 25 Ni 76 Kk e pili ana me ke Kamaheka ma a i Kahi i hoomaka i 24/100 Ika.

April 27, 1852

E. Bailey
Mea ana aina

Uku Tau Ioa #5.

W. H. H. H.
G. M. Robertson
J. K. Kaulahao
J. H. Smith

Honolulu June 25 1852

Heleu 3343 Nihuu I

Waikapu Maui

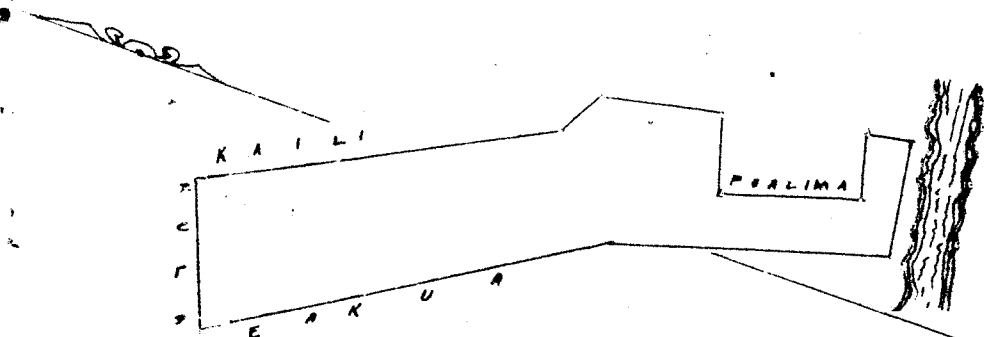

Heleuana 3343 mo Nihuu ili o Palama Waikapu i hoomaka ma ke kahi Komohana a i holo He 35 1/2 Ni 452 Kk e pili ana me ke Akua He 300 Ika ma ke Kekuapaa He 76 1/2 Ni 120 Kk e pili ana me ke Kahawai He 16 1/2 Ni 64 Kk e pili ana me ke Kekuapaa He 9 1/2 Ni 144 Kk e pili ana me ka Poalima He 2 1/2 Ni 150 Kk e pili ana me ka Poalima He 0 Ni 80 Kk e pili ana me ka

Poalima Ak 18 1/2 No 131 Kh e pili ana me Kaiti Ak 64 No 56 Kh e pili ana me Ke Kaiti Ak 32
 No 400 Kh e pili ana me Ke Kaiti Ak 50 1/4 No 162 e pili ana me Ke Kula a i Kahi i hoomaka
 98 Eka
 100
 April 15, 1852
 J. Bailey
 Mea ana aina

Uku Pau Loa 44.

W. H. W.
 G. M. Robertson
 J. Kamaulaha
 J. H. Smith

Honolulu June 25 1852

Hele 3523 Kalahouka Waikapu Maui

Kuleana 3523 me Kalahouka Kaopala Waikapu Maui

Apana 1 I hoomaka ma ke kahi Akau e pili ana me Pahi a e holo Ak 62 1/2 Ni 219 Kh e pili
 ana me Pahi Ak 37 1/2 No 75 Kh e pili ana me Opunui Ak 58 3/4 No 100 Kh e pili ana me Ka Poalima
 ma Ak 47 1/2 No 112 Kh e pili ana me Ka Poalima Ak 39 Ni 112 Kh e pili ana me Ka Poalima
 Ak 38 1/2 No 81 Kh ma Ke Keatini Ak 57 1/2 No 100 e pili ana me Opunui Ak 35 Ni 219 Kh
 e pili ana me Naanaa i Kahi i hoomaka i - 3/10 Eka

Ua Komo Ka Apana 2 i Loko Ke Kahi Apana

Apana 2 I hoomaka ma Ke Kahi Akau e pili ana me Kapa a e holo Ak 47 Ni 148
 Kh e pili ana me Opunui Ak 43 No 103 Kh e pili ana me Ke Ka Poalima Ak 37 1/2 Ni 77 Kh
 e pili ana me Ke Opunui Ak 41 1/2 Ni 39 Kh e pili ana me Ke Naanaa Ak 13 Ni 145 Kh
 pili ana me Ke Poalima a hiki ma Kahi i hoomaka i - 15/100 Eka

.30
 .15
 .50
 1.95

Apana 4c I hoomaka ma Ke Kahi Akau ma Ke Kahawai e pili ana me Kapuaia wa
 a e holo Ak 36 1/4 Ni 290 Kh e pili ana me Ke Kahawai Ak 53 1/4 No 248 Kh e pili ana me
 Kaai a me Poalima Ak 15 1/4 No 108 Kh + Ak 37 No 78 Kh Opunui Ak 14 Ni 94 Kh e pili ana
 me Opunui Ak 44 1/2 No 131 Kh + Ak 60 1/4 No 50 Kh Pahi Ak 25 1/2 Ni 70 Kh + Ak 54 1/2
 No 190 Kh Pahi Ak 30 No 66 Kh e pili ana me Ke Poalima Ak 21 Ni 140 Kh e pili
 ana me Ke Poalima Ak 39 Ni 56 Kh e pili ana me Ke Waiko Ak 22 Ni 53 Kh
 pili ana me Ke Mataia Ak 31 1/2 Ni 45 Kh e pili ana me Ke Kapuaia wa Ak 30
 Ni 280 Kh e pili ana me Kapuaia wa a i Kahi i hoomaka i 1/10 Eka

April 16, 1852

J. Bailey
 Mea ana aina

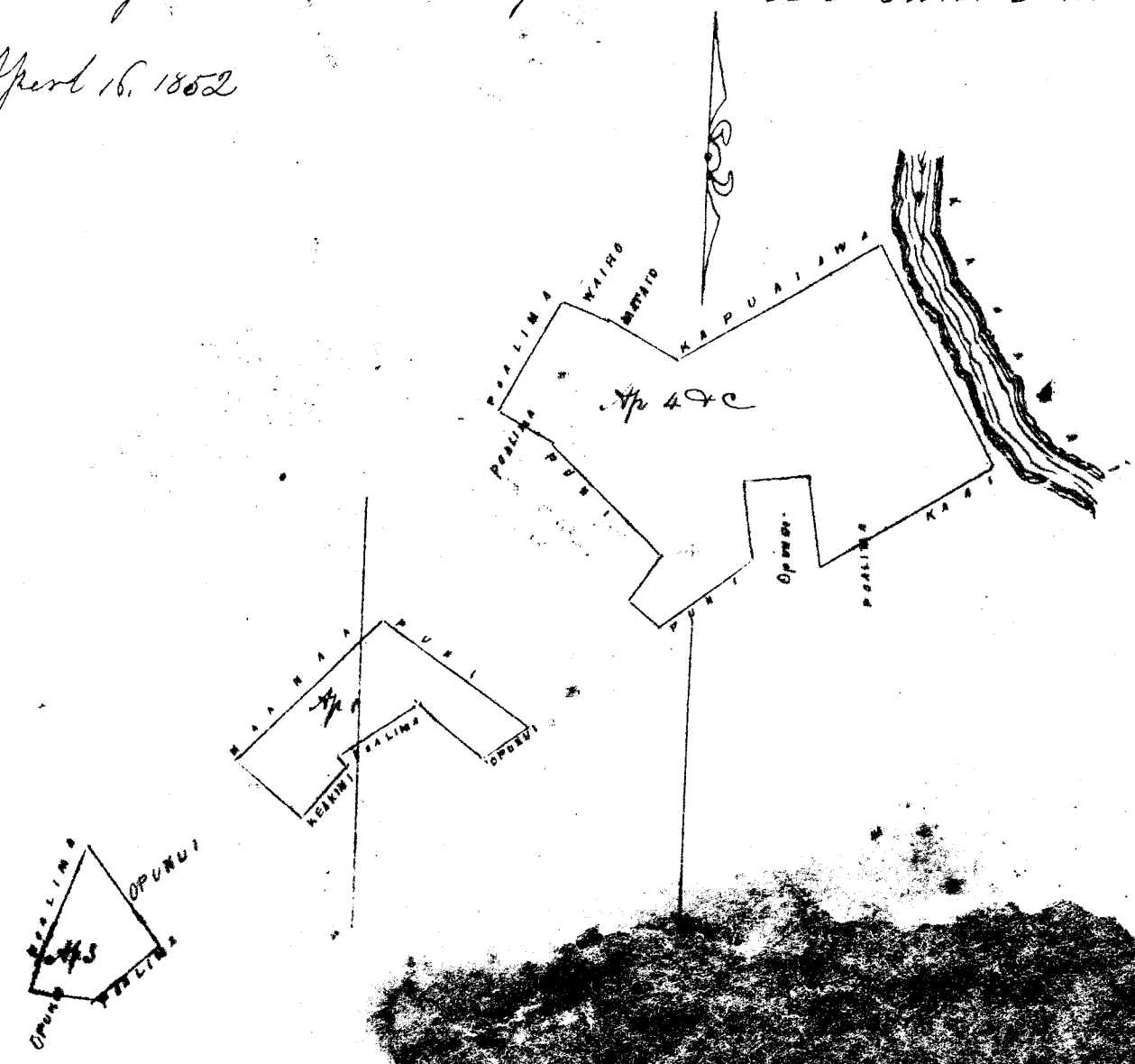

Uku Lan Lan # 6.

W. H. M.
G. M. Robertson
J. K. Kaulahao
J. H. Smith

Honolulu June 25 1852

Hulu 3224 Opunui

Waikapu Maui

Kulana 3224 me Opunui Waikapu Maui
A. B. me ka huihau wa haalele au i ka hulu onua ana o na Apana ku hulu hou keia

Apana 1 Pahale ili. Kaopala E hoomaka ma ke kiki Akau e pili ana me Kalahouka a e holo
Ke 57 1/2 Ni 106 Kk e pili ana me Kalahouka Ke 46 Ni 62 Kk e pili ana me Kaai Ke 50 1/2 Ni 61 Kk e
pili ana me ka ili. Luapuaa Ke 14 Ni 91 Kk e pili ana me ke Kalahouka Ke 77 Ni 78 Kk e pili ana me
ke Kalahouka i kahi i hoomaka i 1/10 Eka

Apana 2 Ili. Kaopala E hoomaka ma ke kiki Komohana e pili ana me ka Poalima a e holo
Ke 27 Ni 83 Kk e pili ana me ka Poalima Ke 63 1/2 Ni 17 Kk e pili ana me ke Kamatai Ke 20 1/2 Ni 62
Kk e Ke 67 Ni 76 Kk e pili ana me Kamatai Ke 20 1/2 Ni 23 Kk e pili ana me ke Kamatai Ke 81 1/2
Ke 106 Kk e pili ana me ke Naanaa i kahi i hoomaka i 12/100 Eka

Apana 3 Ili. Kaopala E hoomaka ma ke kiki Akau e pili ana me Kalahouka a e holo Ke 62 1/2
Ni 87 Kk e pili ana me Kei Ke 34 1/2 Ni 393 Kk e pili ana me ka ili. Luapuaa Ke 67 3/4 Ni 66 Kk
e pili ana me ka ili. Luapuaa Ke 29 1/2 Ni 156 Kk e pili ana me ka ili. Luapuaa Ke 53 1/4 Ni 58
Kk e pili ana me ka ili. Ka Luapuaa e Kaai Ke 36 Ni 184 Kk e pili ana me Kaai Ke 56 1/2 Ni 123
Kk e pili ana me Kekeahewale Ke 45 1/4 Ni 103 Kk e pili ana me ka Poalima Ke 48 1/4 Ni 60 Kk
e pili ana me ka Poalima Ke 28 1/2 Ni 215 Kk e pili ana me ka Poalima Ke 37 1/2 Ni 75 Kk
e pili ana me Kalahouka i kahi i hoomaka i 42/100 Eka

Apana 4 Ili. Kaopala E hoomaka ma ke kiki Akau e pili ana me Naanaa a e holo
Ke 59 1/2 Ni 100 Kk e pili ana me Kalahouka Ke 37 1/4 Ni 87 Kk e pili ana me Keatani Ke 37 1/2
Ni 49 Kk e pili ana me ka Poalima Ke 46 1/4 Ni 38 Kk e pili ana me ka Poalima Ke 78 Ni 100 Kk
e pili ana me Kekeahewale Ke 47 1/2 Ni 57 Kk e pili ana me Kekeahewale Ke 61 1/2 Ni 47 Kk
e pili ana me ka Poalima Ke 47 Ni 148 Kk e pili ana me Kalahouka Ke 53 1/2 Ni 100 Kk
e pili ana me Kepaa Ke 49 Ni 52 Kk e pili ana me Naanaa i kahi i hoomaka i 48/100 Eka

Apana 5 Ili. Kaalaea E hoomaka ma ke kiki Hikina e pili ana me Kaai a e holo
Ke 33 1/4 Ni 115 Kk e pili ana me Kaai Ke 20 1/2 Ni 33 Kk e pili ana me Kaai Ke 20 1/2 Ni 304 Kk
e pili ana me Poepoe Ke 9 1/2 Ni 24 Kk e pili ana me Naanaa Ke 87 3/4 Ni 79 Kk e pili ana
me Kalahouka Ke 33 Ni 204 Kk e pili ana me Poalima e Kaai i kahi i hoomaka i 22/100 Eka

Apana 6 Ili. Loala E hoomaka ma ke kiki makai ma ke Kahawai e pili ana me
Napaitoi a e holo Ke 75 Ni 161 Kk e pili ana me Napaitoi Ke 55 1/2 Ni 54 Kk e pili ana me Napaitoi
Ke 75 Ni 74 Kk e pili ana me Napaitoi i ke Kahawai a ma ke Kahawai e holo ai a loa ke kiki
onua 27/100 Eka

April 23 1852

E. Bailey
Mea ana aina

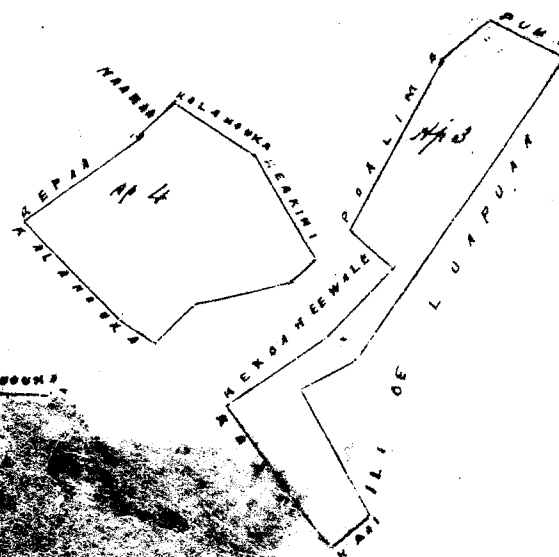
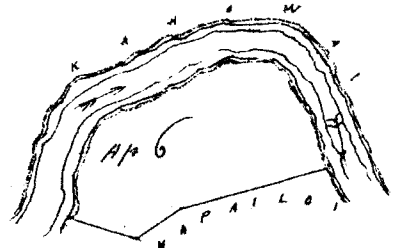

Keolu 3340

Nahau

Waikapu Maui

Keoluana 3340 Nahau Waikapu Maui

Apana 1 Iki o Nohoana E hoomaka ma ke kiki Akau e pili ana me ke Pahoa a e holo He 29° 14' 30" Kh e pili ana me Keuaoloia He 23° No 454 Kh e pili ana me ka Poalima i ke Kahawai alaila hiki ma ke Kahawai a i ke kiki Komohana Ak 73 1/2° No 429 Kh Ak 37 1/2° No 380 Kh e pili ana me Poalima Ak 28 1/2° No 31 Kh e pili ana me Pahoa Ak 54 1/2° No 319 Kh e pili ana Pahoa i kahi i hoomaka i 19/100 Eka

1.09

N.B. ua hui ka Apana 1. Kul. 2959 me kika ma keia paku o Hika ke onake ma o Nahau, a ua onake,

Apana 2 Iki o Olohe oia ka Apana 4 o ke Hika Keoluana e hoomaka ma ke kiki Kina Akau, a e holo Ak 83 1/2° No 234 Kh ma ke Kula Kema 7 1/2° No 387 Kh e pili ana i ke Kula Kema 78 3/4° No 180 Kh e pili ana me ke Kula Ak 15 1/4° No 409 Kh e pili ana me ke Kula i kahi i hoomaka i 8/100 Eka

80
46
1.26

April 14 1852

E Bailey
Ma ana aima

Apana pili me Apana 1 E hoomaka ma ke Kahawai e pili ana me ka u e holo ma ke Kahawai Ak 85° No 345 Kh & He 59 1/2° No 174 Kh alaila He 31 1/2° No 43 Kh & He 75° No 62 Kh ma ke Koa, Ak 63 1/4° No 182 & He 66 3/4° No 179 Kh ma ke Kahawai Ak 44 3/4° No 130 Kh a pili 46/100 Eka

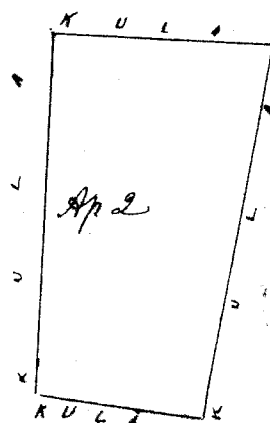
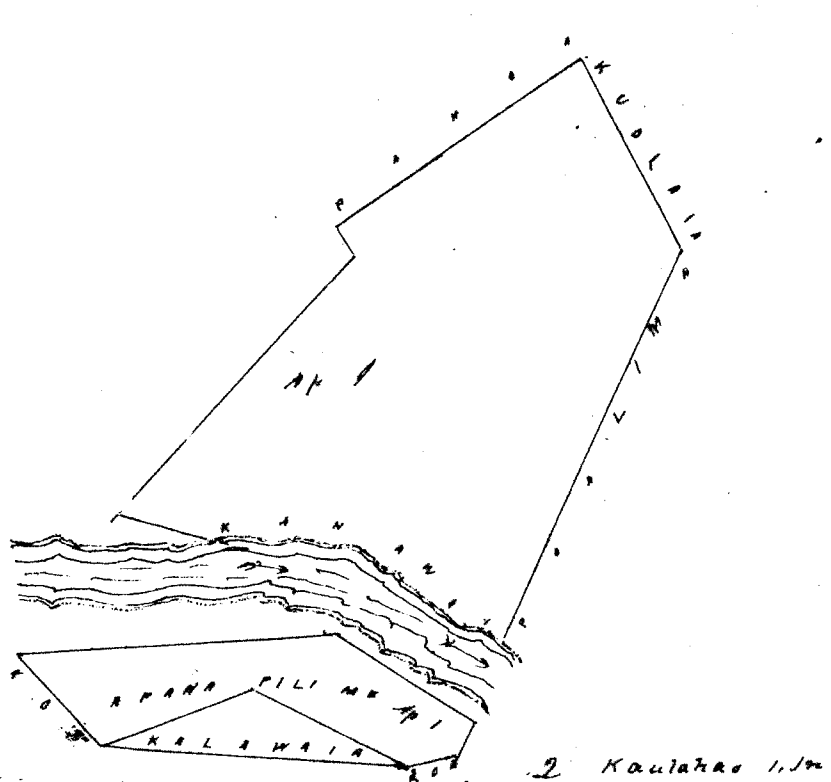

Uku Pau Loa #6.

M. Heu
G. M. Robertson
J. Kaulahoe
P. H. Smith

Honolulu Oahu June 25 1852

Keolu 6041 Eka

Waikapu Maui

Keoluana 6041 me Eka Waikapu Maui

Apana 1 Iki o Makahalahala E hoomaka ma ke Kahawai Kiki Kema e pili ana me ka Poalima He 20° No 276 Kh e pili ana me ka Poalima He 75° No 60 Kh e pili ana me Kekeliiaiku He 23 1/2° No 127 Kh e pili ana me Kekeliiaiku He 64° No 70 Kh e pili ana me Kekeliiaiku He 89° No 61 Kh e pili ana me Kekeliiaiku He 4 1/2° No 131 Kh e pili ana me Kekeliiaiku i ke Kahawai ma ke Kahawai e holo ai a hiki i ke kiki onua 52/100 Eka

Apana 2 Iki o Pili-pili Olohe oia ka Apana 2 ia Mounitu E hoomaka ka Apana 3 ma ke kiki Akau e pili ana me Mounitu a me Papatohoe e holo He 57° No 233 Kh e pili ana me Papatohoe He 3 1/2° No 9 Kh e pili ana i ke Koa Ak 78 3/4° No 320 Kh e pili ana me Kekeliiaiku Ak 40 1/2° No 190 Kh e pili ana me Mounitu i kahi i hoomaka i 37/100 Eka

April 24 1852

E Bailey
Ma ana aima

1 Anna Maria 126

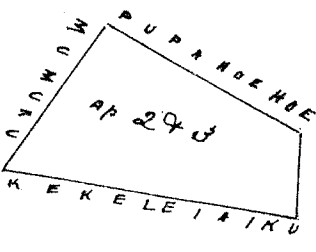
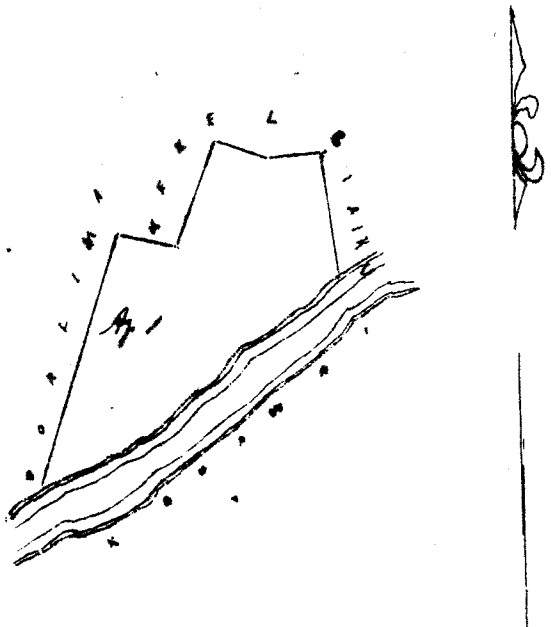

Uku Pau Loa \$5.

M. Hee
G. M. Robertson
J. Kekaulahao
J. H. Smith

Honolulu Oahu June 25 1852

Heu 5324 Keakini

Waikapu Maui

Palapala no ke ana ana i ke Kuleana 5324 no Keakini ma Waikapu Moku o Maui
Apana ma ka ili o Auhanaka ua kuai ia keia apana me ka awaawine no kekahi mau Lina
ma ka Apana 2.

Apana 2, ma ka ili o Kalaupulu i hoomaka ke ana ma ke Kiki Kema. Keia
ua koke i ka puka ma ke kahi awaawine i pili ana me ka ili o Auhanaka a e holo
Ak 2' No 492 Kk ma ka palena. Kula Aupuni Kanae, Ak 74 1/2' No 104 Kk ma ka palena. Moa
huka, me Kanae Ak 4 1/2' Ni 98 Kk ma ka palena. Kanae, Ak 87 1/2' No 123 Kk ma ka palena
o ke Kula Aupuni Ak 7 1/2' Ni 76 Kk ma ka palena. Kanae Ak 78' No 100 Kk ma ka palena
o Kanae, Ak 15' No 385 Kk ma ka palena. Ke Kula Aupuni Ak 67 1/2' Ni 479 ma ka palena. Ke Kula
Aupuni a hiki ma kahi i hoomaka i maoko via anapuni 1 82/100 Eka

Apana 3 ma ka ili o Kalaupulu i hoomaka ma ke Kiki Kema. Keia e pili ana me
ke Kanae me kaai a e holo Ak 33 1/2' Ni 15 Kk ma ka palena. Kaai Ak 65 1/2' No 56 Kk ma ka
palena o Kaai Ak 27 1/2' No 81 Kk ma ka palena o Kaai Ak 68' Ni 72 Kk e pili ana me ke
Kanae, a hiki ma kahi i hoomaka i a maoko via anapuni 5/100 o ka Eka

Apana 4 ma ka ili o Kalaupulu i hoomaka ma ke Kiki Kema. Keia e pili
ana me ke Opunui me Poalima a e holo Ak 40 1/2' Ni 91 Kk ma ka palena o ka Poalima
Ak 39' No 98 Kk e pili ana me Poalima Ak 38 1/2' No 31 Kk ma ka palena. Kalaupulu Ak 31 1/2'
Ni 87 ma ka palena. Opunui a hiki ma kahi i hoomaka i a maoko via anapuni 1/100 o ka Eka
ma ke Kuleana a pau Eka me 7/100 Eka

April 24, 1852

E. Bailey
Moa ana iwa

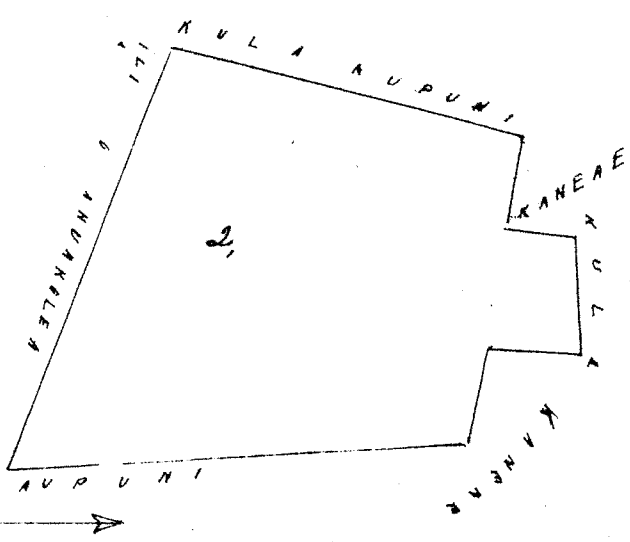
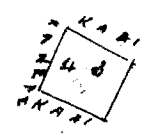

2 Kk 1 In

Uku Pau Loa \$6.

W. L. Hee
G. M. Robertson
J. Kekaulahao
J. H. Smith

Honolulu June 25 1852

Hele 3337 Naamaa

Waikapu Maui

Kutiana 3337 no Naamaa Waikapu Maui

Apana 1, 2, 3. oia Apana 1 ili. Punia E hoomaka ona ke kiki Homohana Akau e pili ana me Kawana a e holo He 60 3/4 Ni 68 Kk e pili ana me Poalima He 81 1/2 Ni 106 Kk e pili ana me Opunui He 84 3/4 Ni 107 Kk e pili ana me Kamakai He 21 Ni 115 Kk e pili ana me Pahi He 55 Kk e pili ana me Kalahouka He 49 Ni 52 Kk e pili ana me Ke Opunui He 80 Ni 105 Kk e pili ana me Kepaa He 25 3/4 Ni 115 Kk e pili ana me Ke Kepaa He 59 Ni 136 Kk e pili ana me Kamohai He 36 1/2 Ni 135 Kk e pili ana me Ke Poalima He 45 1/2 Ni 66 Kk e pili ana me Ke Poalima He 42 Ni 330 Kk e pili ana me Kawana i Kahi i hoomaka i 1/100 Eka

Apana 4 oia Ke Apana 2 Ili. Kaalaa E hoomaka ona ke kiki Akau e pili ana me Ke Kamohai a e holo He 57 Ni 290 Kk e pili ana me Kamohai He 15 3/4 Ni 59 Kk e pili ana me Ke Poalima He 81 1/2 Ni 54 Kk e pili ana me Ke Poalima He 9 1/2 Ni 63 Kk e pili ana me Ke Kalahouka He 74 1/2 Ni 300 Kk e pili ana me Paepe, He 5 1/4 Ni 114 Kk e pili ana me Ke Kula He 16 Ni 92 Kk e pili ana me Ke Kula i Kahi i hoomaka i 45/100 Eka

April 24 1852

32

E Bailey
Mea ana aina

Poalima o Ke Apana 1 mai Ke Kiki Homohana. Kalahouka e ana He 2 Ni 157 Kk i Ke Kiki mua paha He 10 Ni 67 Kk He 80 1/4 Ni 196 Kk He 46 Ni 67 Kk He 77 1/2 Ni 225 Kk a puni 1/100 Eka.

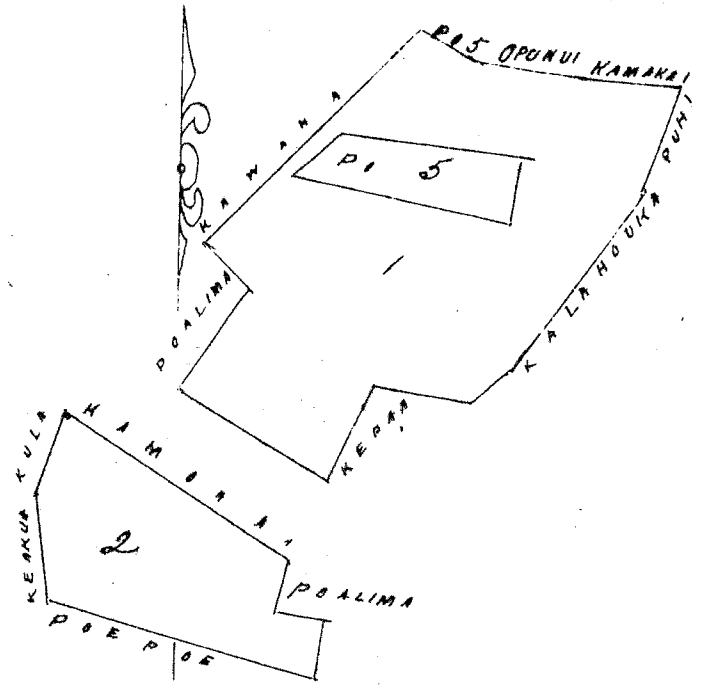

Uku Pau Loa #5

W. H. H. H.
G. M. Robertson
J. K. Kaulahoa
J. H. Smith

Honduli Oahu June 25 1852

Hele 10460 Kalei

Waikapu Maui

Kutiana 10460 no Kalei Waikapu Maui

Apana 1 Ili. Luapuaa E hoomaka ona ke kiki Akau e pili ana me Pahi a me Opunui a e holo He 45 1/2 Ni 165 Kk e pili ana me Ke Copp & Kaai He 49 Ni 184 Kk e pili ana me Ke Poalima & Kea He 48 3/4 Ni 40 Kk e pili ana me Ke Poalima & Kaai He 58 1/2 Ni 85 Kk e pili ana me Ke Poalima He 37 Ni 348 Kk e pili ana me Ke Copp He 36 3/4 Ni 60 Kk e pili ana me Ke Copp He 41 Ni 335 Kk e pili ana me Ke Copp He 50 1/2 Ni 70 Kk e pili ana me Ke Copp He 44 3/4 Ni 132 Kk e pili ana me Ke Copp He 85 3/4 Ni 47 Kk e pili ana me Ke Copp He 34 1/2 Ni 280 Kk e pili ana me Opunui i Kahi i hoomaka i 65/100 Eka

Apana 2 Ili. Olohe E hoomaka ona Ke auwai kiki Homohana Akau a e holo He 89 Ni 81 Kk e pili ana me Kacha He 4 1/2 Ni 82 Kk e pili ana me Kacha He 77 Ni 85 Kk e pili ana me Kacha He 14 Ni 100 Kk e pili ana me Kaauwai i Kahi i hoomaka i 7/100 Eka.

April 22 1852

E Bailey
Mea ana aina

Hoolia Keia

See Page 26.

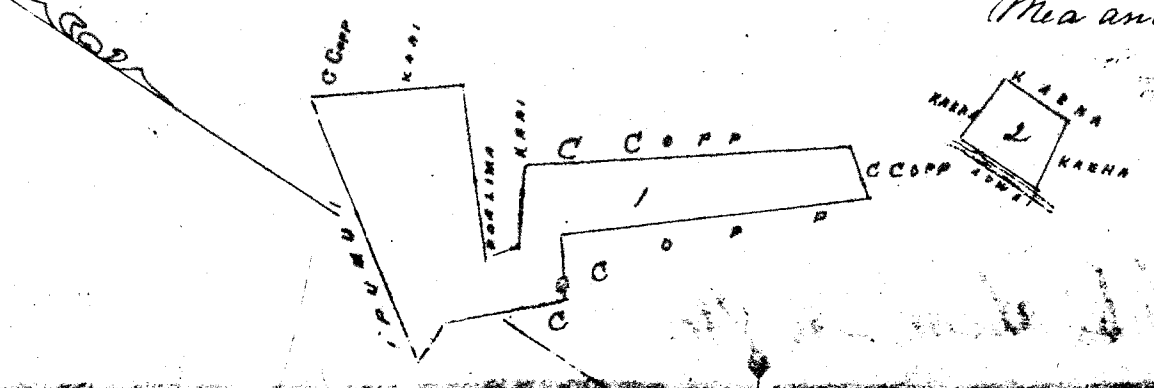

Uku Pau Loa #4.

W. H. H.
G. M. Robertson
J. Hekaulaha
C. H. Smith

Honolulu June 25 1852

Hele 3013 Kalaiaia

Waikapu Maui

Kuleana 3013 no Kalaiaia Waikapu Maui

Apana 1 Ili i Pihoku E hoomaka ma ke kahi Komohana e pili ana me Koa a e holo He 48 1/4 He 147 1/2 Ah e pili ana me Kuaolua He 11 He 25 Ah e pili ana me Ka Ili Paahao He 80 He 145 Ah e pili ana me Koa He 23 1/2 He 176 Ah e pili ana me Koa He 6 1/4 He 182 Ah e pili ana me Nahau He 66 1/2 He 179 Ah e pili ana me Nahau i Kahi i hoomaka i 48. Eka

Apr 27 1852

Ua huiia ka Apana 2 me ke Nahau.

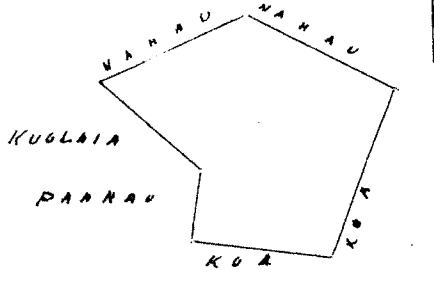

E. Bailey
Ma ana aina

Uku Pau Loa #4.

W. H. H.
G. M. Robertson
J. Hekaulaha
C. H. Smith

Honolulu June 25, 1852.

Hele 2499 Chunnui

Waikapu Maui

Palapala o ke ana ana i ke Kuleana 2499 no Chunnui ma Waikapu Mokupuni o Maui

Apana 1 ma ka Ili o Olohe E hoomaka ke ana ma ka auwai Kahi Akau o Keia e pili ana me ke Kamakaipooa e holo He 69 1/4 He 258 Ah ma ka palena o Kamakaipooa He 73 1/2 He 162 Ah e pili ana me Kahakumakaai He 20 1/4 He 214 Ah e pili ana me Aokiki o Ana Kula He 23 1/2 He 223 Ah e pili ana me Kacha i ka auwai He 4 He 243 Ah ma ka auwai a hiki ma Kahi i hoomaka i a onalohi via anapuni Ewalu hapaumi 2/3 o ka Eka

Apana 2, Ua huiia me ke Nahau

Apana 3 Ma Pihoku Ili E hoomaka ke ana ma ka auwai Kahi Akau o Keia e pili ana me ke Kelihoa oia hoi. Koa a e holo He 74 1/2 He 119 1/2 Ah ma ka palena o Koa He 10 1/2 He 84 Ah ma ka palena o Koa He 8 1/4 He 39 Ah ma ka palena o Koa He 11 He 78 Ah ma ka palena o Koa He 70 He 218 Ah ma ka palena o Koa o Kamakaipooa Akau poma 147 Ah e pili ana ma ka auwai a hiki ma Kahi i hoomaka i a onalohi via anapuni Ewalu hapaumi o ka Eka (2/3) a onalohi. Keia Kuleana Aokiki Eka me ke hapaumi

E. Bailey

Ma ana aina

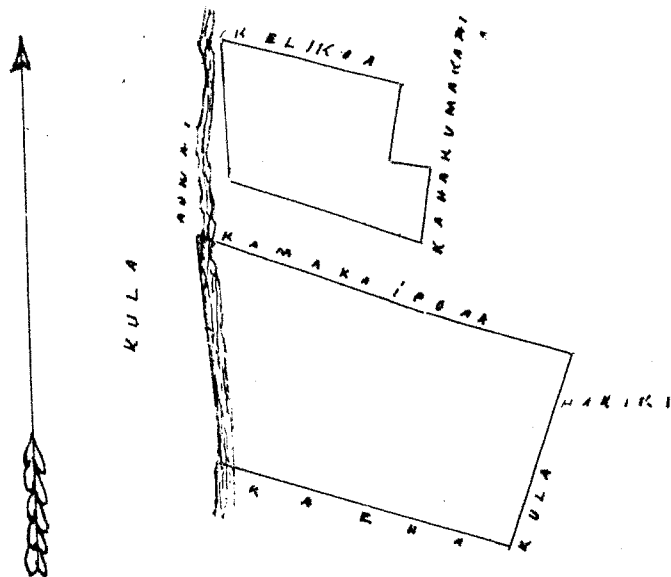

Uku Pau loa #5.

W. H. H.
G. M. Robertson
J. Hekaulaha
C. H. Smith

Honolulu June 25, 1852.

Hulu 3109 Kauhalea

Waikapu Maui

Palapala no ke ana ana i Ke Kauhalea 3109 no Kauhalea ma Ka ili o Kuaiwa Waikapu Mokapu Maui
 E hoomaka ma Ke Kahi Komohana. Keia Apana aina e pili ana me Ka ahi o Ke Kahi. Pili
 ili ma Ka auwai e holo A 12' Hi 154 Kk ma Ka auwai me Ka palena. Kahi He 80 1/2' Hi 269 Kk
 ma Ka palena. Kaha AK 54' Hi 200 Kk ma Ka palena. Kaha me Ke Kahi Palena He 15' He 200
 e pili ana me Ke Palena He 72' Hi 74 Kk e pili ana me Ke Palena AK 17' Hi 230 Kk ma Ke
 palena. Ke Palena He 67' Hi 42 Kk ma Ka palena. Kahi ia (J.R.) He 67 1/2' Hi 347 Kk e pili
 ana me J. Richardson He 18 1/2' He 168 Kk ma Ka palena. Kekeleiaiku AK 65 1/2' He 136 Kk ma Ka
 palena. Kekeleiaiku He 9 1/2' He 56 Kk ma Ka palena. Kekeleiaiku AK 73 1/2' He 358 Kk ma Ka
 palena. Kekeleiaiku ia Palakiko AK 8 1/4' Hi 45 Kk ma Ka palena. Palakiko o Frank. AK 80 1/2'
 He 121 ma Ka palena. Palakiko o Frank He 27' He 75 Kk e pili ana me Palakiko i Ka loi Pa-
 hao AK 87 1/2' He 219 Kk ma Ka palena Ii Pahaia & Kahi i hoomaka i a
 maloko oia anapuni 1 3/100 Eka

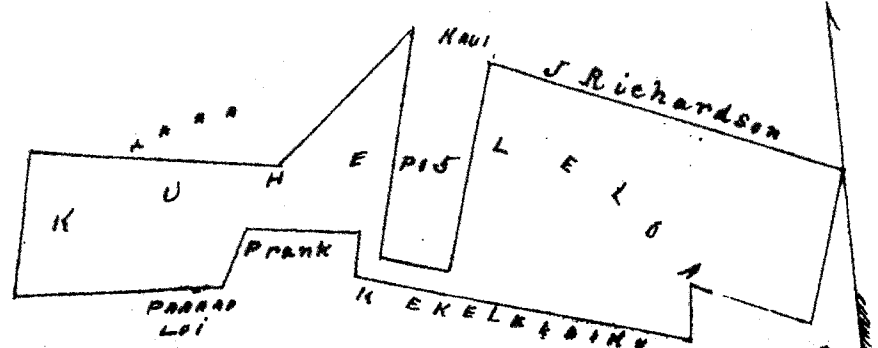

E. Bailey
 Mea ana aina

2 Kaulahas 1 Aika

Uku Pau Ioa \$5.

- W. H. H.
- G. M. Robertson
- J. Kekaulahas
- J. H. Smith

Honolulu June 25 1852

Hulu 3547 Kaulaha

Waikapu Maui

Palapala o Ke ana ana i Ke Kauhalea 3547 no Kaulaha ma Ka ili o Ohia Waikapu Mokapu Maui
 o Maui E hoomaka Ke ana ma Ke Kahi Ahaunalua. Ke auwai e pili ana me Ke Kahi ma Ke Kahi
 aina a e holo, He 51 1/4' He 304 Kk ma Ke Ke Anapuni palena He 47' Hi 235 Kk ma Ke Kaulamaku palena He
 29' Hi 500 Kk e pili ana ma Ke Kaulamaku palena He 36' Hi 106 Kk ma Ka palena. Ke Kaulamaku
 a hiki i Ke Palena AK 53 1/4' Hi 202 Kk ma Ke Ke Palena AK 47 1/4' Hi 146 Kk ma Ke Palena
 AK 57 1/4' He 779 ma Ke Kaulaha a hiki ma Kahi i hoomaka i a maloko oia anapuni 2 1/100 Eka

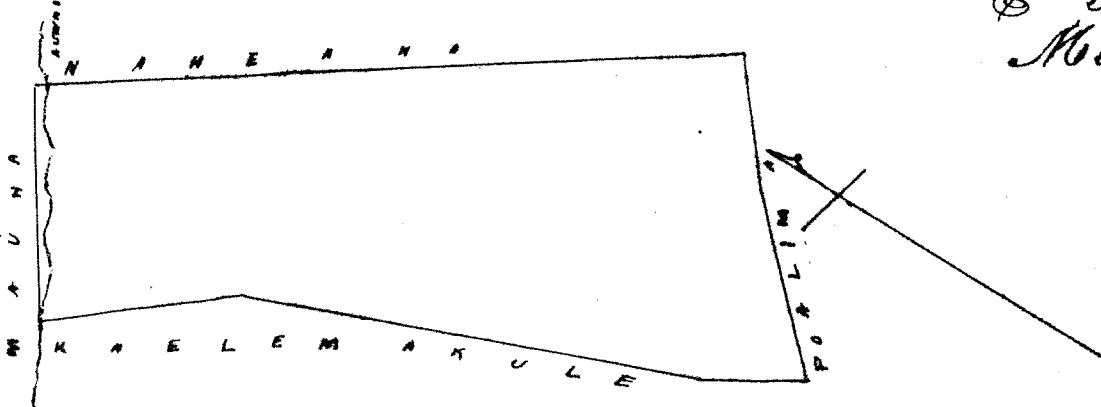

E. Bailey
 Mea ana aina

Uku Pau Ioa \$6.

- W. H. H.
- G. M. Robertson
- J. Kekaulahas
- J. H. Smith

Honolulu June 25 1852

Hulu 2424 Kawapalaole

Waikapu Maui

Kauhalea 2424 no Kawapalaole Waikapu Maui
 Ii. Waikapu E hoomaka ma Ke Kahi Kema e pili ana me Kama a e holo AK 52 1/2' He 78
 Kk e pili ana me Kama. AK 51' Hi 157 Kk e pili ana me Ke Kahi. He 52 1/2' Hi 214 Kk e pili
 ana me Kapa, He 51 1/4' Hi 129 Kk e pili ana me Kapa AK 62' Hi 179 Kk e pili ana me Ke
 pau, He 24' Hi 119 Kk e pili ana me Kapa He 58 1/2' He 406 Kk e pili ana me Kaulaha
 hooma i Kahi i hoomaka i a maloko oia anapuni 1 4/100 Eka

E. Bailey
 Mea ana aina

Honolulu June 25 1852

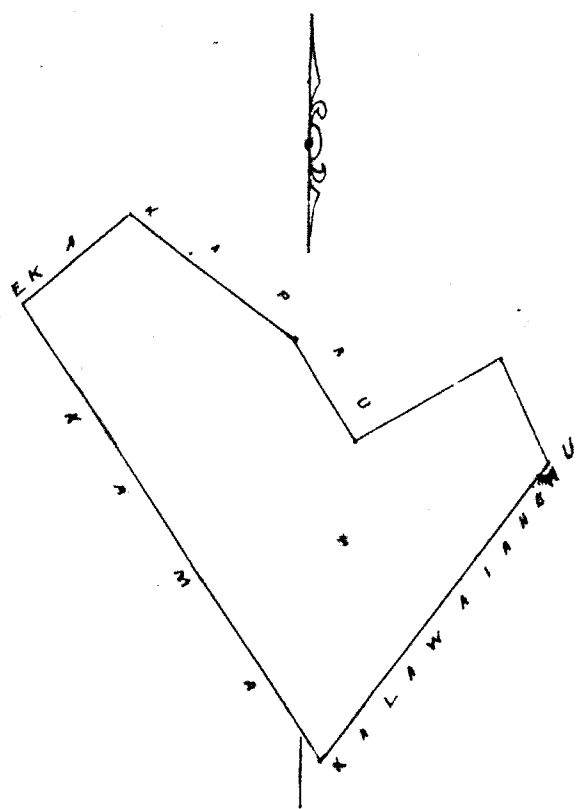

Uku Pau Loa #5.

W. Hee
G. M. Robertson
J. H. Smith

Honolulu June 25 1852 J. Hekeaulahao

Heleu 5282 Hanepuakewa

Waikapu Maui

Hukana 5282 no Hanepuakewa ili. Auwaiolimu Waikapu Maui
E hoomaka ma ke kahi Akaun e pili ana me George Shaw a e holo ke 74 ki 400 kha e pili
ana me Geo Shaw ke 60° ki 247 kha e pili ana me George Shaw ke 42 1/2° ki 108 kha e pili
ana me George Shaw ke 64 1/4° ki 133 kha e pili ana me George Shaw ke 71 1/2° ki 268 kha e pili
ana me Maui ke 72° ki 388 kha e pili ana me Maui ke 25 1/4° ki 178 kha e pili ana me ka
ili o Pili-pili i Kahi i hoomaka i 122/100 Eka

April 17 1852.

J. Bailey
Mea ana aina

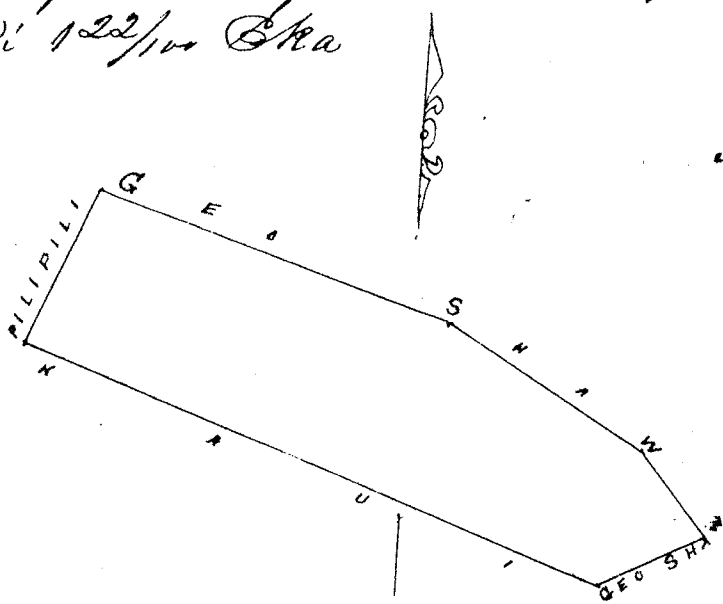

Uku Pau Loa #5.

W. Hee
G. M. Robertson
J. H. Smith

Honolulu June 25 1852 J. Hekeaulahao

Heleu 2199 Pahoa

Waikapu Maui

Falafala me ke ana ana i ke hukana 2199 no Pahoa ma ka ili o Haaiwo Waikapu Moku-puni. Maui.
E hoomaka ma ke kahi Kikina o Kia Apana e pili ana me Kuloia Kekeluaia a me Moomuku a e
holo ke 27 ki 184 kha ma ka palena. Moomuku ke 19 1/2° ki 149 kha ma ka palena. Moomuku a Kokohe i ka
hale Kula ke 89 1/2° ki 514 kha ma ka palena Kula. Waikapu o Frank Sylva ke 8° ki 380 kha ma ka
palena Kula. Waikapu o Frank Sylva ke 40° ki 29 kha e pili ana me ke Kula. Waikapu o Frank
Sylva i ka Palima Loi ke 18 1/2° ki 40 kha ma ka palena. Ka Palima ke 40° ki 102 kha ma ka
palena. Ka Palima ke 38 1/2° ki 227 kha ma ka palena. Ke Kahau, ke 31 1/2° ki 40 kha ma ka
Kahau Frank S. ke 28 1/2° ki 31 kha ma ka Kahau Frank S. ke 54 1/4° ki 15 kha ma ka Frank S.
ke 35 1/4° ki 22 kha ma ka Frank S. ke 54 1/4° ki 90 kha ma ka Frank S. ke 25 1/4° ki 22
kha ma ka Frank S. i ka Kahau ke 54 1/4° ki 244 kha ma Kahau + Kuloia ke 13 1/2°
ki 135 kha e pili ana me Kuloia ke 81° ki 192 kha ma Kuloia a hiki ma ka ili
i hoomaka a maboke via anapuni 2 26/100 Eka.

Palima malik via apana mai Kahi Komohana Akaun. E ana mai ke
mo ana ma ka Kana a i Kela Kahi alaila ke 88° ki 157 kha ma ke Kahi Akaun

Keia Poalima alaila holo 145 1/2 Ki 58 Kh A 70° Ki 96 Kh A 15 1/2 K 32 Kh Kema 85 Kora
98 Kh a puni ma ia anapuni 4/10 Ke Kaulahao

E Bailey
Ma ana alua

HALK KURE

2.26
40
36

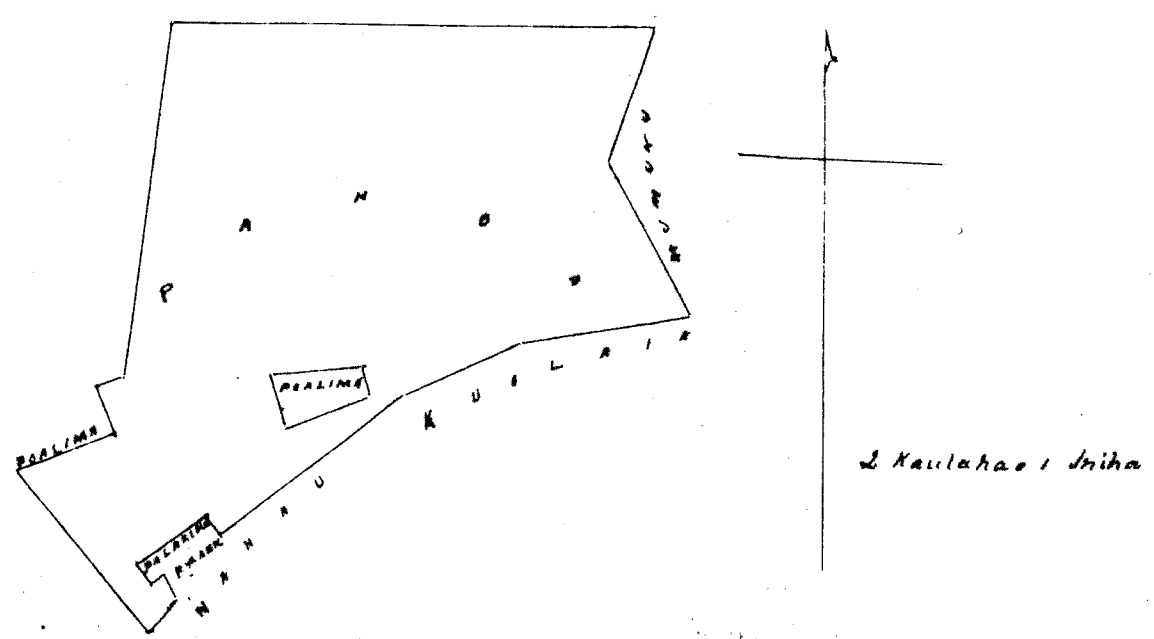

Uku Pau Loa #6.

W. H. K.
G. M. Robertson
J. H. Smith

Honolulu Oahu June 25 1852 J. H. Kaulahao

Hulu 10160 Maahoe

Waikapu Maui

10160 Maahoe Waikapu Maui

Apana 1 Ili. Ahuakolea E hoomaka ona Ke auwai Kiki Akau e pili ana me Wahimailii
a e holo Ke 65 1/2 Ki 56 Kh e pili ana me Wahimailii Ke 4° Ki 27 Kh e pili ana me Anapuni paha Ke 5 1/2
Ke 121 Kh e pili ana me Anapuni paha Ke 23 1/2 Ke 194 Kh e pili ana me Anapuni paha Ke 85 1/2 Ke 30
Kh e pili ana me Anapuni paha Ke 5° Ke 758 Kh e pili ana me Ke auwai a me Ke ili. Waikalulu a hiki
ona Kahi i hoomaka i 1/100 E Ka

1.99
3
2.08

Apana 4 Ili. Kikia E hoomaka ona Ke Kiki Kema a e holo Ke 6 1/2 Ke 12 Kh e pili
ana me Ke Kula Ke 80° Ki 113 Kh e pili ana me Ke Kula Ke 28 1/2 Ki 12 Kh e pili ana me Ke
Kula Ke 79° Ke 130 Kh e pili ana me Ke Kula i Kahi i hoomaka i 2/10 Kaulahao

Ua paa ona Apana 273 onahua. Ke Kulu ana. Haa a ua hoko ia nona
E Bailey
Ma ana aima
April 16, 1852

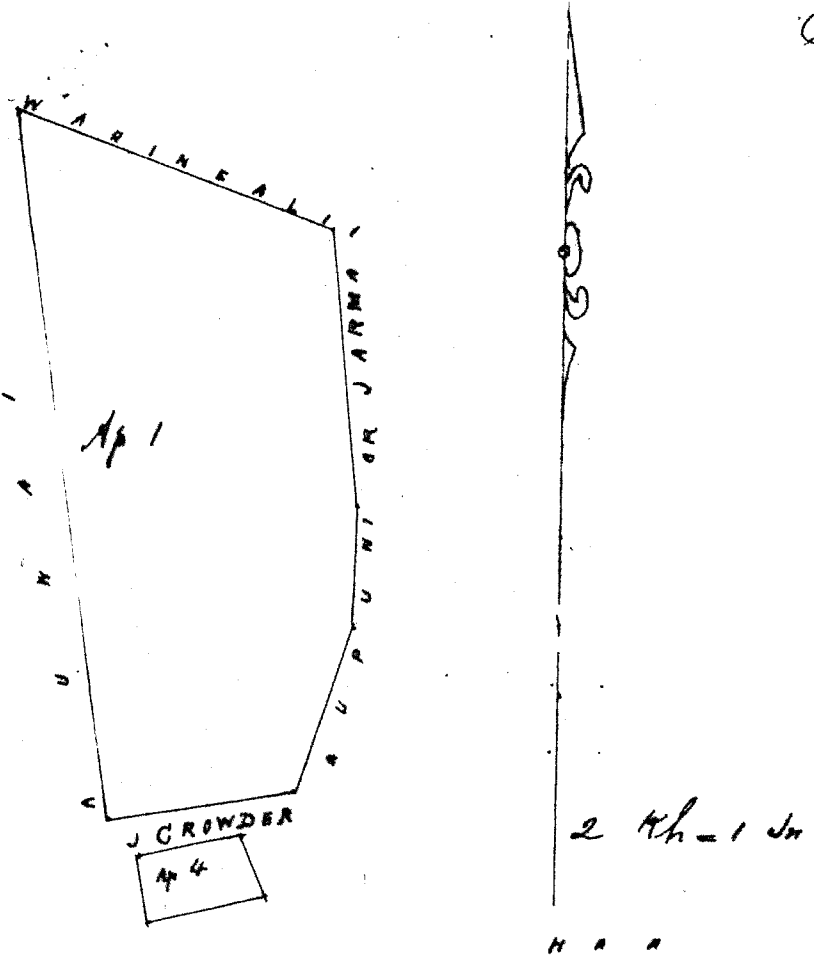

Uku Pau Loa #5.

W. H. K.
G. M. Robertson
J. H. Smith

Hono

Hulu 3110 Kuluia

Waikapu Maui

Kuliana 3110 No. Kuluia Waikapu Maui

Apana 1 Ili. Nohoana Choomaka ona Ke Kiki Akau Epili ana me Mumuku a e holo
No 7 1/4 No 322 Kh e pili ana me Kikeliaina No 78 1/2 No 158 Kh e pili ana me Ka Poalima No 29
No 230 Kh e pili ana me Kahau, No 65 1/2 No 135 Kh e pili ana me Pahoa No 81 No 192 Kh
e pili ana me Pahoa i Kahi i hoomaka i 6/100 Eka

Apana 2 Ora hui ia me Ke Kaulamakule - ae ia

Apana 3 Ili. Pihoku Mahale i Choomaka ona Ke Kiki Komoana Akau Epili ana me
Poalima a e holo No pumi 79 Kh e pili ana me Poalima No 81 1/2 No 88 Kh e pili ana me
No 6 1/2 No 98 Kh ma Ke Kula i Kahi i hoomaka i 8/100 Eka

Apana 3 Mahale 2 Choomaka ona Ke Kiki A e pili ana me Katalawaia A e holo
No 48 1/4 No 105 Kh ma Katalawaia No 85 3/4 No 77 Kh ma Ka Pahoa No 24 1/2 No 65 Kh e pili ana me
No 33 Kh ma Ke Kula a pumi 4/100 Eka

Ua haalele ia i Ka Apana 4

Apr 28 1852

E. Bailey
Moa ana aina

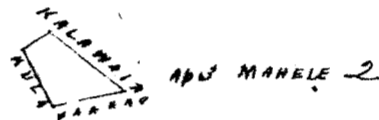
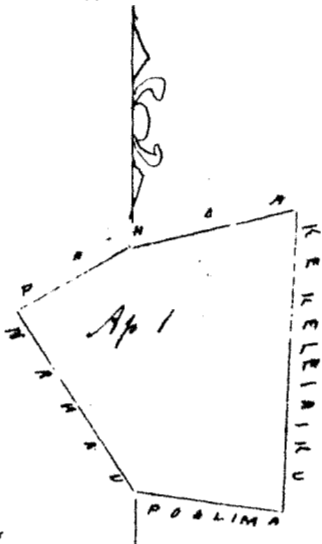
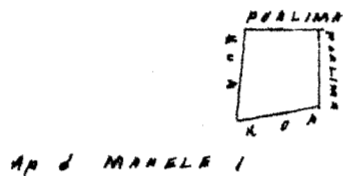

2 Kh - 1 in

Uku Pau Loa # 4

M. H. H.
G. W. Robertson
J. H. Smith

Honolulu Oahu June 25 1852

J. Kikantakas

Hulu 2416 Kapuhana

Waikapu Maui

Kuliana 2416 no Kapuhana ili. Kapatalaia Waikapu Maui

Choomaka ona Ka paaina a uwai Kiki Kom Akau e pili ana me Pipii A e holo No 84 No 1123
Kh e pili ana me Pipii J R. No 25 No 348 Kh e pili ana me J. Richardson No 81 3/4 No 274
Kh e pili ana me J. Richardson No 85 1/4 No 705 Kh e pili ana me Kalapuna No 3 1/2 No 344
Kh e pili ana me Ka uwai pa i Kahi i hoomaka i 36/100 Eka

Poalima mai Ke Kiki Komoana Aina e ana aku No 38 No 145 Kh i Ke Kiki
ma ataila holo Akau pumi 73 Kh Kiki pumi 53 Kh Aina pumi 73 Kh Komoana pumi
53 Kh a pumi 4/100 Eka

Apr 30 1852

E. Bailey
Luna ana aina

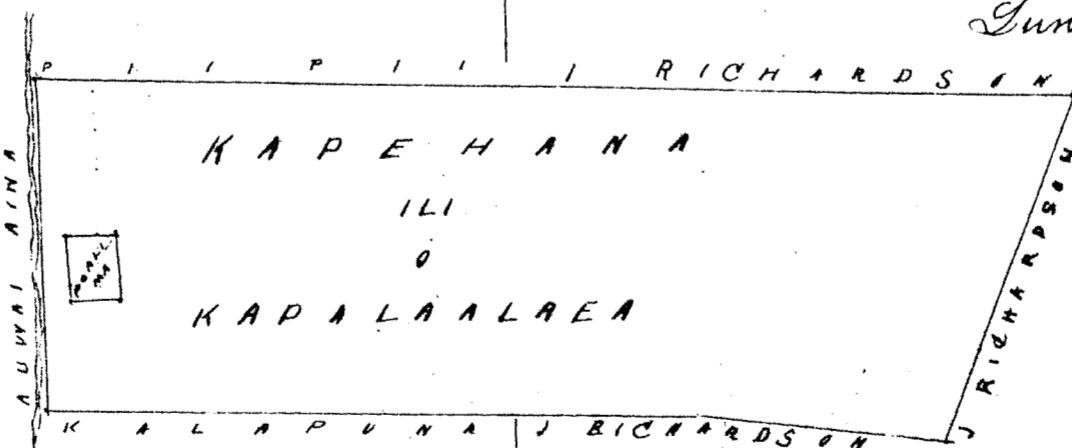

Uku Pau Loa # 7

M. H. H.
G. W. Robertson
J. H. Smith

J. Kikantakas

Honolulu Oahu June 25 1852

Hele 5280 Koaui

Waikapu Maui

Kulana 5280 no Koaui ili o Auwailimu Waikapu Maui
 E hoomaka ma ke Pihikiki a e pili ana me Kamupuahewa a e holo He 72° He 358 Kk e pili ana me
 Kamupuahewa He 71 1/4° He 268 Kk e pili ana me Kamupuahewa He 80° He 390 Kk e pili ana me
 Geo Shaw He 34° He 223 Kk e pili ana me J Richardson AR 23 1/2 He 498 Kk e pili ana me
 J Richardson AR 58 1/2 He 236 Kk e pili ana me J Richardson AR 14 He 54 Kk e pili ana me
 J Richardson AR 67 1/2 He 132 Kk e pili ana me J Richardson He 22 He 152 Kk e pili ana me
 J Richardson AR 67 He 134 Kk e pili ana me Poalima & C AR 23 1/4 He 198 Kk e pili ana me ka
 'hi o Pili-pili i Kahi i hoomaka'i 168/100 Eka

E Bailey
 mea ana aina

Apr 17, 1852

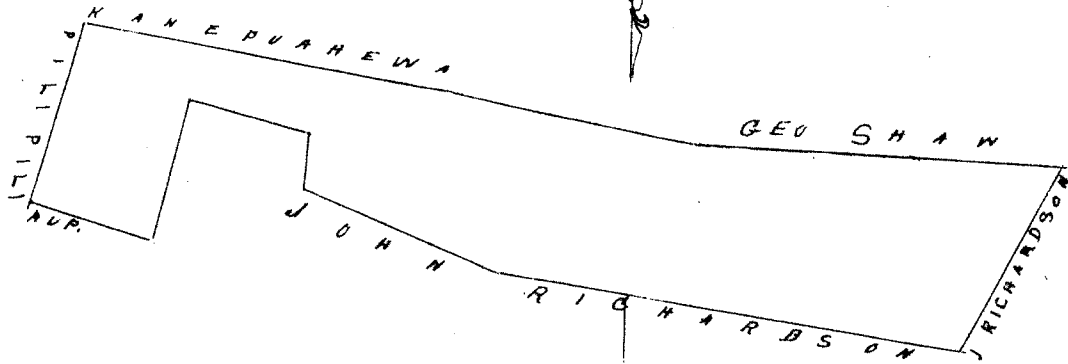

Uku Pau Loa # 5.

Uku
 G. M. Robertson
 J. H. Smith

Komolulu Oahu June 25 1852 J. Kaulahao

Hele 3506 Kamakai

Waikapu Maui

Kulana 3506 no Kamakai ili o Kaopala, Waikapu Maui
 E hoomaka ma ke Pihikiki a e pili ana me ka Hakiki a me Kamohai a e holo He 23 1/4 He 220 Kk e pili ana
 me Hakiki He 78 3/4 He 73 Kk e pili ana me ka Poalima He 21 He 175 Kk e pili ana me ka Poalima & Pihikiki
 AR 85 3/4 He 107 Kk e pili ana me Kaunaa AR 20 3/4 He 123 Kk e pili ana me Opunui AR 69 3/4 He 86
 Kk e pili ana me Opunui He 20 1/2 He 62 Kk e pili ana me Opunui AR 68 3/4 He 147 Kk e pili ana
 me Poalima AR 43 1/2 He 140 Kk e pili ana me Kamohai i Kahi i hoomaka'i 40 Eka

Ua hui ia ka Apana e 2 me ke Waiko me ka ae mai. Ka me ke Kulana
 E. Bailey
 mea ana aina

Apr 16, 1852

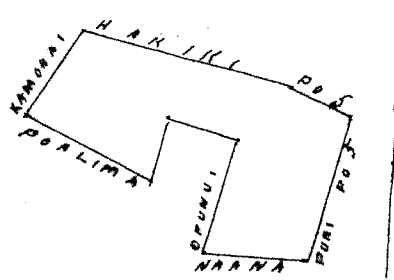

Uku Pau Loa # 4.

Uku
 G. M. Robertson
 J. H. Smith

Komolulu June 25 1852 J. Kaulahao

Hele 3296 Moemuku

Waikapu Maui

Kulana 3296 no Moemuku Waikapu Maui
 Ili o Auwailimu E hoomaka ma ke Pihikiki a e pili ana me Nauahi Kukulaiaku & Pimpahoa a e holo He 34 1/4
 He 447 Kk e pili ana me Pimpahoa He 40 1/4 He 190 Kk e pili ana me Nauhia AR 78 3/4 He 78 Kk e pili ana
 me Kukulaiaku AR 29 He 184 Kk e pili ana me Pahra AR 19 1/2 He 375 Kk e pili ana me Pahra & Kula
 He 89 1/2 He 232 Kk e pili ana me Kula He 85 3/4 He 181 Kk e pili ana me Nauahi i Kahi i hoomaka'i 162
 Eka

E Bailey
 mea ana aina

Apr 15, 1852

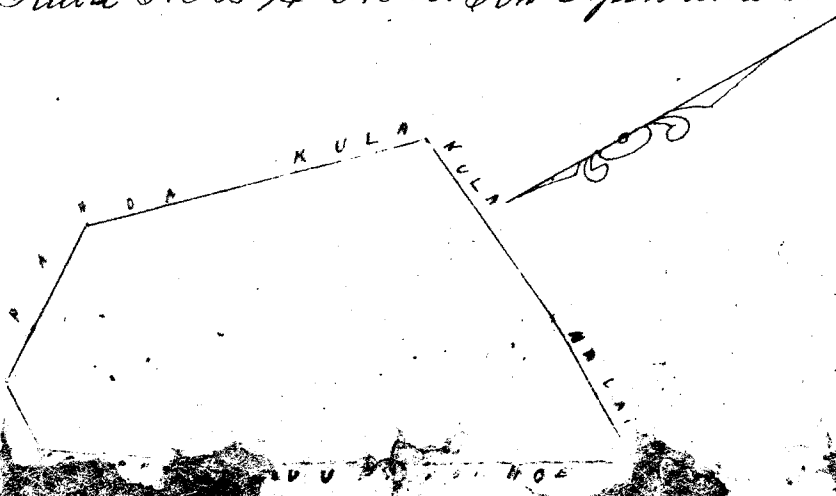

W. H. K.
G. M. Robertson
J. H. Smith

Honolulu June 25 1852 / J. Kekaulahas

Hulu 18460 Nalii / Waikapu Maui

Kulana 18460 no Nalii Waikapu Maui

Apana 1 Ua Romo Keia Apana i loki, Ke Kulana. C. Copp. a ua hokoria mona

Apana 2, ili, Olohe E hoomaka ma Ka auwai Kiki Komohana Akau a e hulu AK 89°
41' 81' Kh e pili'ana me Kacha, Ke 4 1/2' 82' Kh e pili'ana me Kacha AK 77' 85' Kh e
e pili'ana me Kacha AK 13 1/4' 100' Kh e pili'ana me Ka auwai i Kahi i hoomaka: 700' Eka

Apr 16, 1852

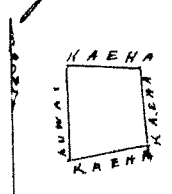

E Bailey
Mea ana aina

W. H. K. #4.

W. H. K.
G. M. Robertson
J. H. Smith

Honolulu June 25 1852 / J. Kekaulahas

Hulu 1882 Paalea / Palolo Waikiki Oahu

Paalea

Apana 1 Moaina, Puakea ili, Kiki Palolo Waikiki Oahu
E hoomaka ma Ke Kiki Komohana Akau Ake ana Hem 25' Kom: 60' Kh ma Ka palena. Kapahulu
malaila aku Hem 49° 41' 150' Kh ma Ka palena no Konoehiki malaila aku AK 19° 41' 200' Kh
ma Ka palena. Konoehiki malaila aku Hem 35' 140' Kh malaila aku AK 14° 41' 142' Kh ma
Ka palena no Konoehiki malaila aku Hem 70' 1064' Kh malaila aku AK 20° 41' 170' Kh
ma Ka palena no Kawaihae malaila aku Hem 68° 41' 082' Kh malaila aku Hem 16' Kom: i
0, 70' Kh ma Ka palena no Kawaihae malaila aku, AK 79° Kom: i 050' Kh malaila aku,
Hem 12' Kom: i 180' Kh ma Ka palena Koke malaila aku, Hem 15° 41' i 090' Kh ma Ka palena
no Konoehiki malaila aku, AK 13 1/2' 492' Kh ma Ka pa aina malaila aku AK 68°
Kom: i 190' Kh ma Ka palena no Upupe malaila aku Hem 25' Kom: i 142' Kh ma
Ka palena no Kawaihae malaila aku, AK 65' Kom: i 120' Kh malaila aku AK 54° 41'
i 184' Kh ma Ka palena no Kawaihae malaila aku AK 66° Kom: i 140' Kh ma Ka palena no
Upupe a hiki i Ka hoomaka ana 2 Eka 1 Kh huinaha

Apana 2 Mo. Puakea ili, Kiki Palolo Waikiki
E hoomaka ma Ke Kiki Komohana a hulu ana AK 67° Kom: i 610' Kh ma Ka palena no Heawe mal-
aila aku, AK 16° 41' i 523' Kh ma Ka palena. Kapahulu malaila aku Hem 60° 41' 266' Kh
ma Ka palena no Paalea malaila aku Hem 21' Kom: i 140' Kh ma Ka palena no Palahi
malaila aku, Hem 62° 41' i 080' Kh malaila aku AK 27° 41' i 124' Kh malaila aku
AK 62° 41' 112' Kh ma Ka palena no Paalea malaila aku Hem 18' Kom: i 154' Kh ma Ka
palena hale. Kawaihae malaila aku Hem 76° 41' i 20' Kh ma Ka palena hale.
Kawaihae malaila aku, Hem 15' Kom: i 184' Kh ma Ka palena pa aina a hiki i Ka
hoomaka ana, 1 Eka 4 2/3' Kh huinaha

Paulea 3 Eka 5 2/3' Kh, huinaha

A Bishop
Mea ana

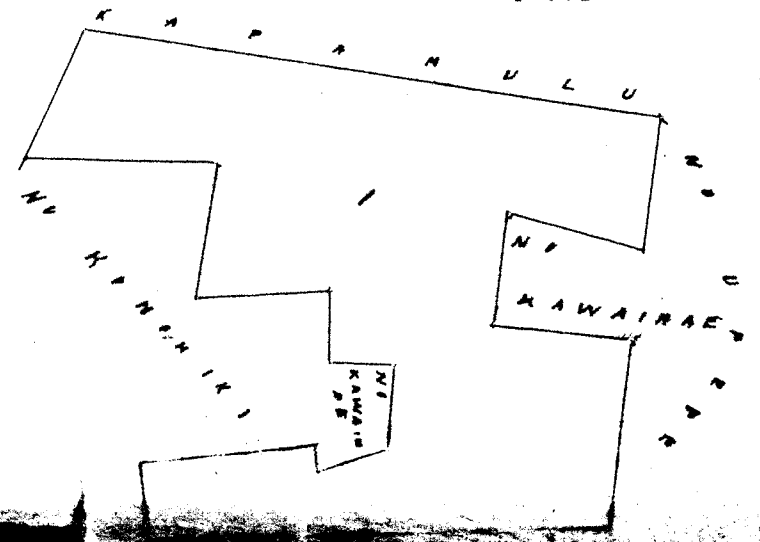
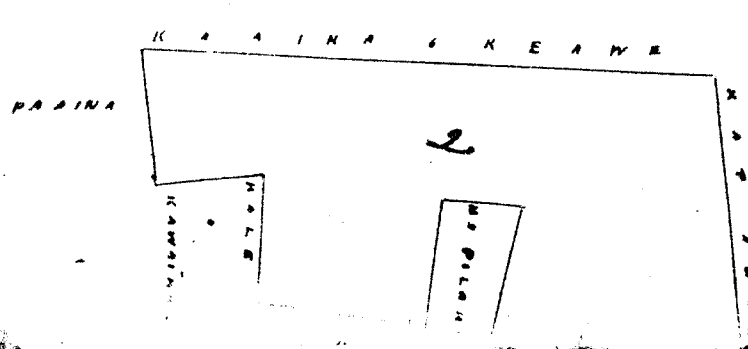

Uku Pau Ioa \$ 7.00

H. M. Robertson
J. H. Smith

Honolulu June 25 1852

J. Kekaulahao

Hele 6716 Hoanua + 518 Vol. 10

Waikiki Oahu

Apana 1 Ioi me Ka auwai i Keauhou ili, Kamookahi Waikiki Oahu.
E hoomaka ana ma Ke Kahi Kama e hulu AK 34° Kom: 115 Ah ma Ka palena no Makuaole malai
la aku AK 33 1/2° NIK: 294 Ah ma Ka palena no Maka malaila aku Kom 34° NIK 115 Ah ma
Ka palena Kahawai malaila aku Kom 33 1/2° Kom: 294 Ah ma Ka palena no Makoli a hiki i
Ka hoomaka ana, 3 3/8 per Haulahao huinaha

Apana 2 Mookalo, Keauhou ili, Kamookahi
E hoomaka ana ma Ke Kahi Kama e hulu Kom 48° NIK: 400 Ah ma Ka palena no Hauwa
hele malaila aku, AK 44° NIK: 535 Ah ma Ka palena no Keoni Ana, malaila aku AK 49° No
400 Ah ma Ka palena no Kamaukoti malaila aku Kom 44° Kom: 535 Ah ma Ka palena no Keuakaha
a hiki i Ka hoomaka ana, 2 Eka 4 7/8 per Ah huinaha

Apana 3. Mookalo i loko, Kalohelele Waikiki
E hoomaka ana ma Ke Kahi Kama e hulu AK 60° NIK: 380 Ah ma Ka pa auwai malaila aku
Kom 37° NIK: 700 Ah ma Ka palena no Kahiatahu malaila aku Kom 60° Kom: 200 Ah ma
Ka palena no C. Hanaina malaila aku AK 55° Kom: 720 Ah ma Ka palena no Ma Kua
ava, a hiki i Ka hoomaka ana, 1 Eka 7 5/8 per Ah huinaha hui ma Apana 3, 4 Eka 16 1/8 per Ah
huinaha

Helewa Keia ana ana E noma 518 Vol. 10

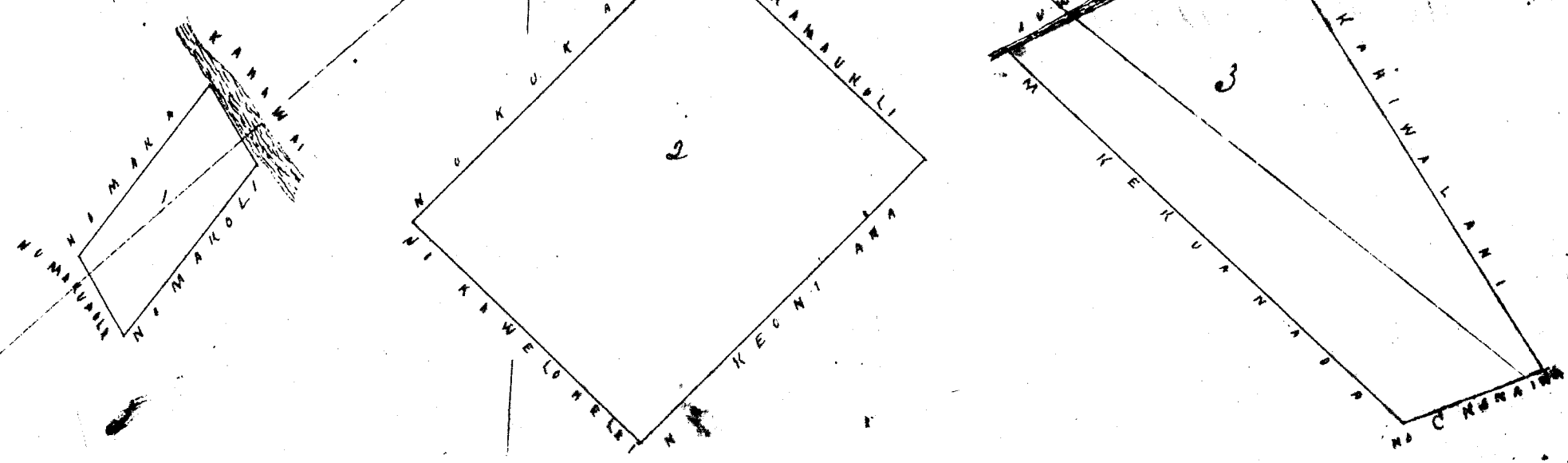

Uku Pau Ioa \$ 9.00

H. M. Robertson
J. H. Smith

Honolulu June 25 1852

J. Kekaulahao

Hele 8289 Hoanua

Palolo Oahu

Moo Kihia ili o Waialupe Palolo Oahu

Apana 1 E hoomaka ana ma Ke Kahi AKau e hulu ana Kom 52 1/2° NIK: 0.60 Ah ma Ka pal
ma no Konohele malaila aku Kom 55 Kom: 0.15 Ah malaila aku Kom 62 1/2° NIK: 0.30 Ah malai
aku AK 42° NIK: 0.50 Ah malaila aku Kom 54° NIK: 0.85 Ah malaila aku Kom 34 Kom: 0.70
Ah malaila aku Kom 88 1/2° NIK: 0.12 Ah malaila aku Kom 39° Kom: 0.20 Ah malaila aku Kom 60
NIK: 2.50 Ah ma Ka palena no Konohele malaila aku, Kom 46° Kom: 1.14 Ah ma Ka palena Kolu
malaila aku, AK 49° Kom: 0.85 Ah ma Ka palena no Pupuawa malaila aku AK 50° NIK: 0.28 Ah
malaila aku, AK 45° Kom: 3.10 Ah ma Ka palena no Pupuawa malaila aku Kom 27 1/2° Kom: 1.8
Ah malaila aku, AK 46 1/2° Kom: 1.30 Ah ma Ka palena no Pupuawa malaila aku, AK 45°
i: 0.70 Ah malaila aku AK 25° NIK: 0.60 Ah a hiki i Ka hoomaka ana 5 2/3 per Ah huinaha

Apana 2, Ili i loko o Kihia ili o Waialupe
E hoomaka ana ma Ke Kahi Kama e hulu ana AK 48° NIK: 1.50 Ah ma Ka palena Kolu
aku, Kom 45° NIK: 4.36 Ah malaila aku Kom 64° Kom: 1.89 Ah ma Ke Konohele

44 5° Kom i 400 Kh ma Ra palena no Pupuawa a hiti i Ra hoomaka ana 6 7/100 Kh huinaha
 Pau loa i Eka 199/100 Kh huinaha
 A. Bishop Mea ana

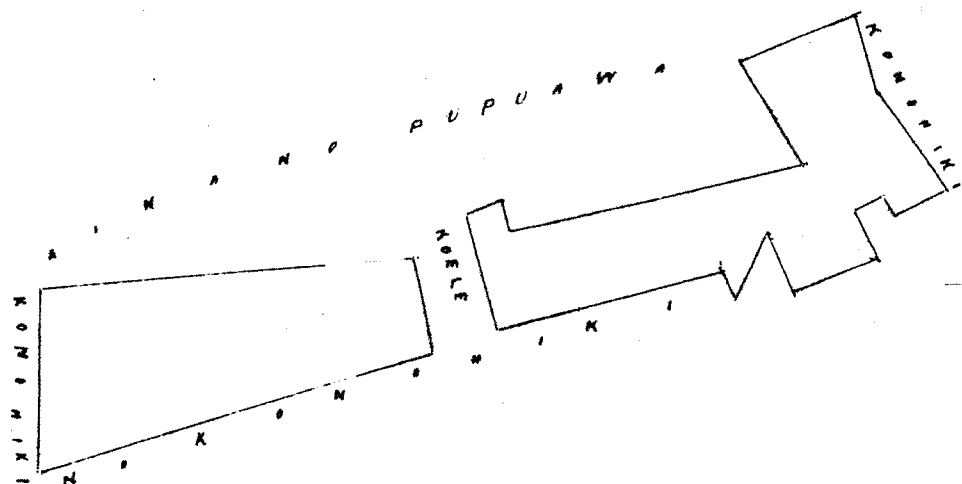

Kaumaka

Apana 3 E hoomaka ana Ke Kiki Kikina E hui ana Kom 25 Kom i 180 Kh malaila aku
 AK 65 Kom i 150 Kh malaila aku AK 25 AK 180 Kh malaila aku Kom 65 Hit i 150 Kh ma puni
 i Ke Kono hiti He 270 Kh huinaha Pau loa i Eka 4 69/100 Kh huinaha

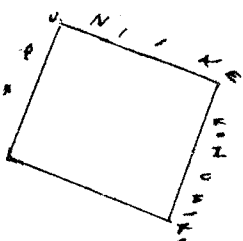

A. Bishop
 Mea ana

Uku Pau Loa \$ 6.00

M. Lee
 G. M. Robertson
 J. St. Smith

Honolulu June 25 1852 J. Kekaulaheo

Hohe 1649 Pupuawa

Talolo Oahu

Mo Kumuhaui i Waikupe Talolo Oahu

E hoomaka ana Ke Kiki Kikina e hui ana AK 37 Hit i 100 Kh ma Ra palena. Kono hiti malaila
 aku AK 48 Kom 050 Kh ma Ra palena no Kaumaka malaila aku AK 28 Hit i 028 Kh malaila
 palena Kele, malaila aku Kom 64 Hit i 424 Kh ma Ra palena no Amata a hiti i Ra hoomaka
 ana He 707/100 Kh huinaha

Apana 2 4 Poi i loku. Namoo Kumuhaui

E hoomaka ana Ke Kiki Kikina e hui ana AK 48 Hit i 118 Kh ma Ra palena Kele malaila aku
 AK 27 Kom i 088 Kh ma Ra palena no Miki malaila aku AK 50 Hit i 028 Kh malaila aku
 AK 43 Kom 318 Kh ma Ra palena no Miki malaila aku Kom 27 1/2 Kom i 200 Kh ma Ra palena no
 Kono hiti malaila aku Kom 46 1/2 Hit i 150 Kh ma Ra palena no Amata malaila aku AK 44
 Hit i 050 Kh malaila aku Kom 42 1/2 Hit i 170 Kh ma Ra palena no Amata a hiti i Ra hoomaka
 ana He 524/100 Kh huinaha Huina i Eka 237/100 Kh huinaha

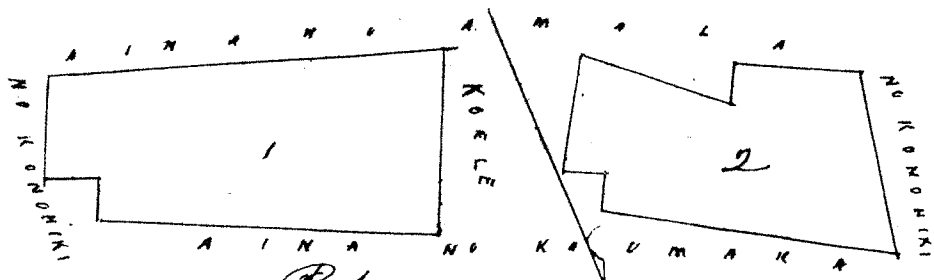

Pupuawa

A. Bishop Mea ana

Apana 3 He Kakuahale i Mauele Talolo Oahu

E hoomaka ana Ke Kiki Kikina Apana E hui ana Kikina i 180 Kh malaila aku Kom
 i 180 Kh malaila aku Komohana i 180 Kh malaila aku AK 130 Kh ma puni i Ke ana.
 Kono hiti He 234/100 Kh i loku

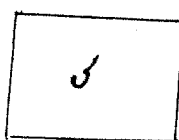

A. Bishop
 Mea ana

Uku Pau Loa \$ 6.00

M. Lee
 J. St. Smith
 G. M. Robertson

Honolulu July 5 1852

J. Kekaulaheo

7.07
 1.237
 2.34
 2.178

Heleu 8285 Kewane

Taloto Waitiki Oahu

Apana 1 He moa aina i loko. Heleu Taloto Waitiki Oahu
 E hoomaka ana ma ke Pihiki Kima e hiki ana AK 24° NIK i 370 Kh ma ka papa aina malaila
 aku AK 51° NIK i 140 Kh ma ka palena ma Konoiki malaila aku AK 57° NIK i 333 Kh
 malaila aku AK 44° NIK i 170 Kh ma ka palena ma Konoiki malaila aku AK 11° NIK
 i 92 Kh ma ka palena Koke, malaila aku AK 54° NIK i 200 Kh ma ka palena Koke
 malaila aku, AK 21° NIK i 100 Kh ma ka palena. Heleu malaila aku, AK 70° NIK
 i 33 Kh ma ka palena. Maano malaila aku, AK 43° NIK i 63 Kh ma Konoiki
 malaila aku, AK 25° NIK i 200 Kh ma ka palena malaila aku AK 51° NIK i 386 Kh
 ma ka palena Koke a hiki i ka hoomaka ana i Eka 4³²/₁₀₀ Kh huinaha

Apana 2 E Kolu Loi i loko. Heleu Taloto Oahu
 E hoomaka ma ke Pihiki Aka e hiki ana AK 75° NIK i 074 Kh ma ka palena ma Koke malaila aku
 AK 13° NIK i 150 Kh ma ka palena ma Koke malaila aku, AK 85° NIK i 060 Kh ma ka papa aina ma
 laila aku, AK 65° NIK i 156 Kh ma ka palena Koke. Heleu malaila aku AK 9° NIK i 100 Kh
 ma ka palena Koke. Heleu malaila aku, AK 65° NIK i 131 Kh ma ka palena Koke malaila
 aku AK 27° NIK i 180 Kh a hiki i ka hoomaka ana i Eka 3³³/₁₀₀ Kh huinaha

Pau loa i Eka 8¹⁵/₁₀₀ Kh huinaha

At Bishop
Mea ana

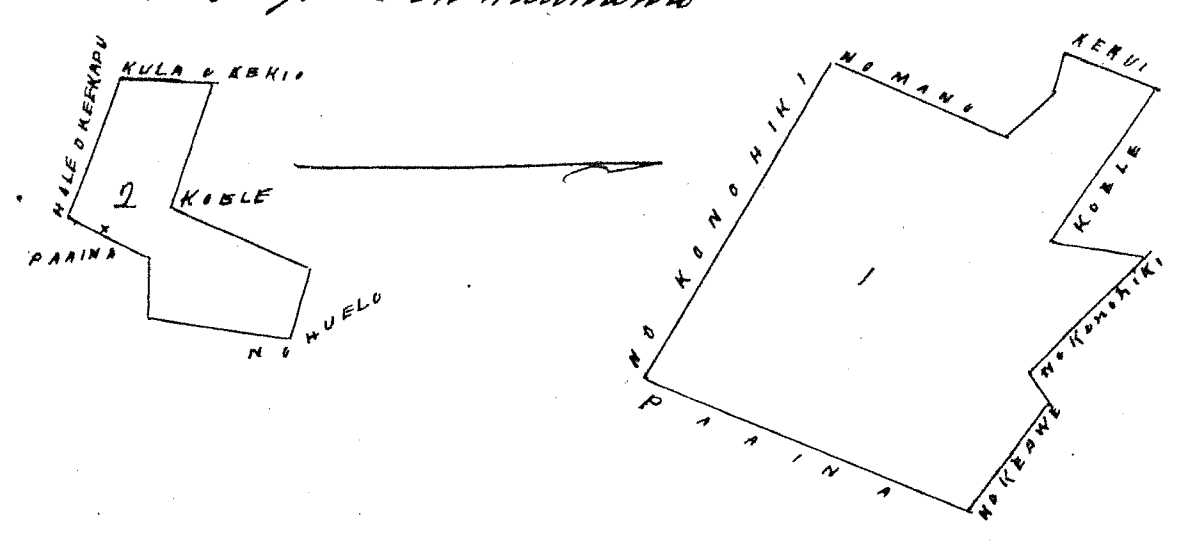

Uku Pau Loa # 6. 00
Heleu

J. Kekaulaha
G. M. Robertson
J. H. Smith

Honolulu Iulai 5, 1852

Heleu 2619 Pahau

Waitiki Oahu

He moa aina i loko. ka ili. Opukeala Waitiki Oahu
 E hoomaka ma ke Pihiki Aka e hiki ana, ma ka papohaku, AK 33° NIK i 338 Kh ma ka papa aina ma Paale
 malaila aku AK 43° NIK i 540 Kh ma ka palena ma Paale malaila aku AK 43° NIK i 120 Kh malaila
 aku, AK 78° NIK i 117 Kh ma ka palena ma Kahuahinu malaila aku, AK 51° NIK i 722 Kh ma ka papa
 ma Keku ahike malaila aku, AK 14° NIK i 140 Kh ma ka palena ma Kapaakea malaila aku AK 45° NIK i
 535 Kh ma ka Kapaakea malaila aku AK 43° NIK i 348 Kh ma Kahuahinu. Kapaakea malaila aku
 AK 72° NIK i 360 Kh ma ka palena ili. Kapaakea malaila aku AK 17° NIK i 173 Kh malaila aku
 AK 70° NIK i 454 Kh ma ka palena. Kapaakea a hiki i ka hoomaka ana i Eka 1⁹²/₁₀₀ Kh huinaha

At Bishop
Mea ana

Olelo hooakaa,
 Ma hu, keia keia ana
 ana e keia Kuleana
 o Pahau ma ke
 ka keia ana mai
 o C. Hamana
 ke Konoiki, a ua
 huolua ana huia
 o J. H. Kalama ana
 ka la 16 Feberuari
 1852 a ua ana ana
 a J. H. Kalama
 ka papa, ua keia
 keia ana ana.

Sana aoe 604 Buks. 5 Huia.
C. Hamana

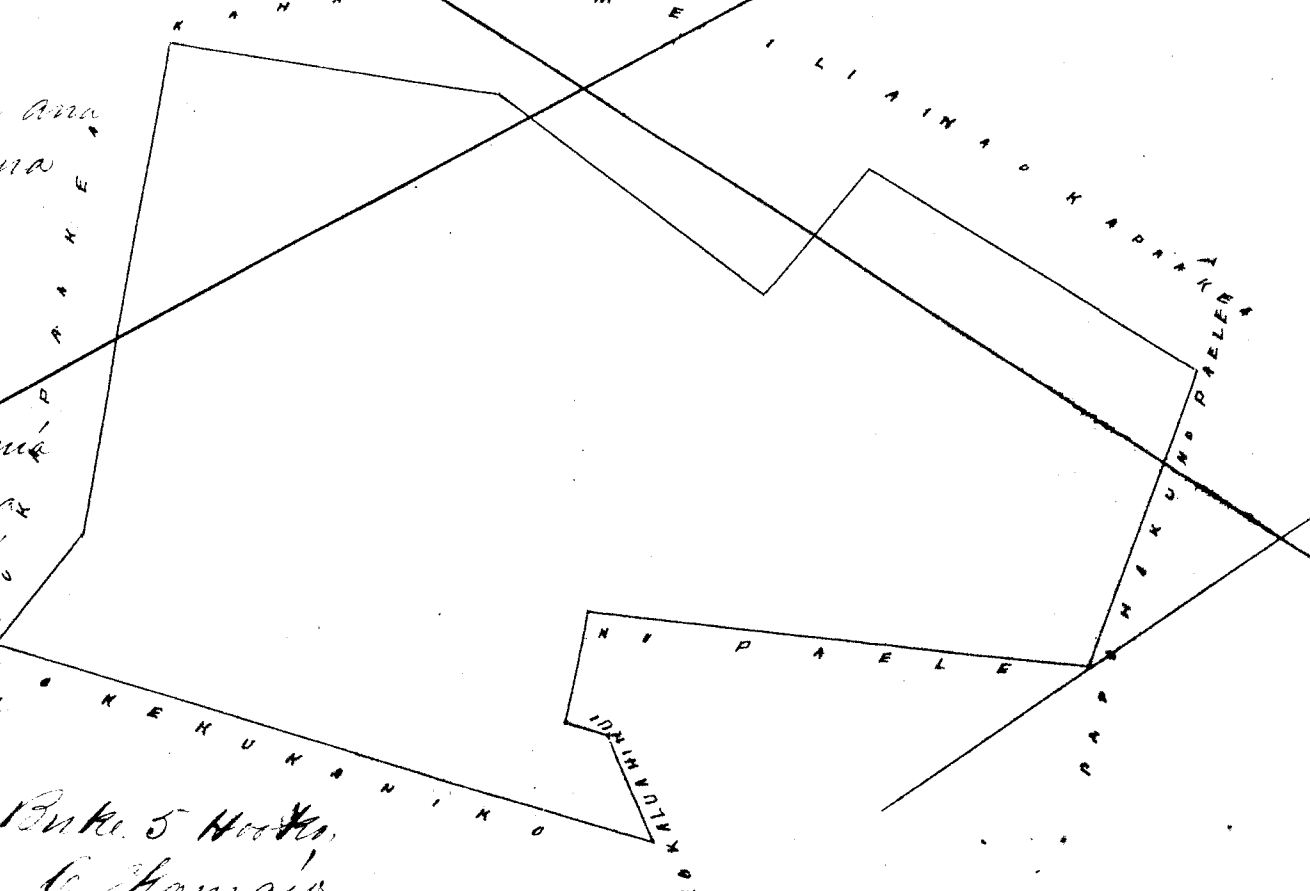

Uku Pau Loa \$ 10.00

Honolulu Julai 5 1852

Hulu 1896 Moahana

Palolo Oahu

Mou Anapapa ili o Kapahulu Palolo Oahu
 E hoomaka ma ke kiki Moahana E hulu ana AK 20° Hiki i 900 Ah ma ka palena o Honolulu malaila
 aku hem 60° Hiki 452 Ah ma ka palena o Hanalei malaila aku AK 63° Hiki 146 Ah malaila aku hem 66°
 Hiki 214 Ah ma ka palena o Keana malaila aku hem 27° Hem i 905 Ah ma ka palena o Paea malaila
 aku hem 86° Hiki i 200 Ah malaila aku hem 20° Hem 200 Ah ma ka palena o Honolulu malaila aku
 AK 59° Hem 152 Ah malaila aku AK 8 1/2° Hem i 054 Ah malaila aku AK 67° Hem i 700 Ah ma ka palena o
 Hele a hiki i ka hoomaka ana 6 Eka 6 92/100 Ah huinaha

Apana E ke Kula malaila ma Hanalei ili o Kapahulu
 E hoomaka ma ke kiki Hele ana AK 69° Hem i 220 Ah ma ka palena o Paea malaila aku hem 27 1/2°
 Hem i 532 Ah ma ka palena o Honolulu malaila aku hem 60° Hiki i 200 Ah malaila aku AK 27 1/2° Hiki 532
 Ah ma ka palena o Paeha a hiki i ka hoomaka ana 8 Eka 0 64/100 Ah huinaha
 Pau Loa : 7 Eka 7 56/100 Ah huinaha

A Bishop Ma ana

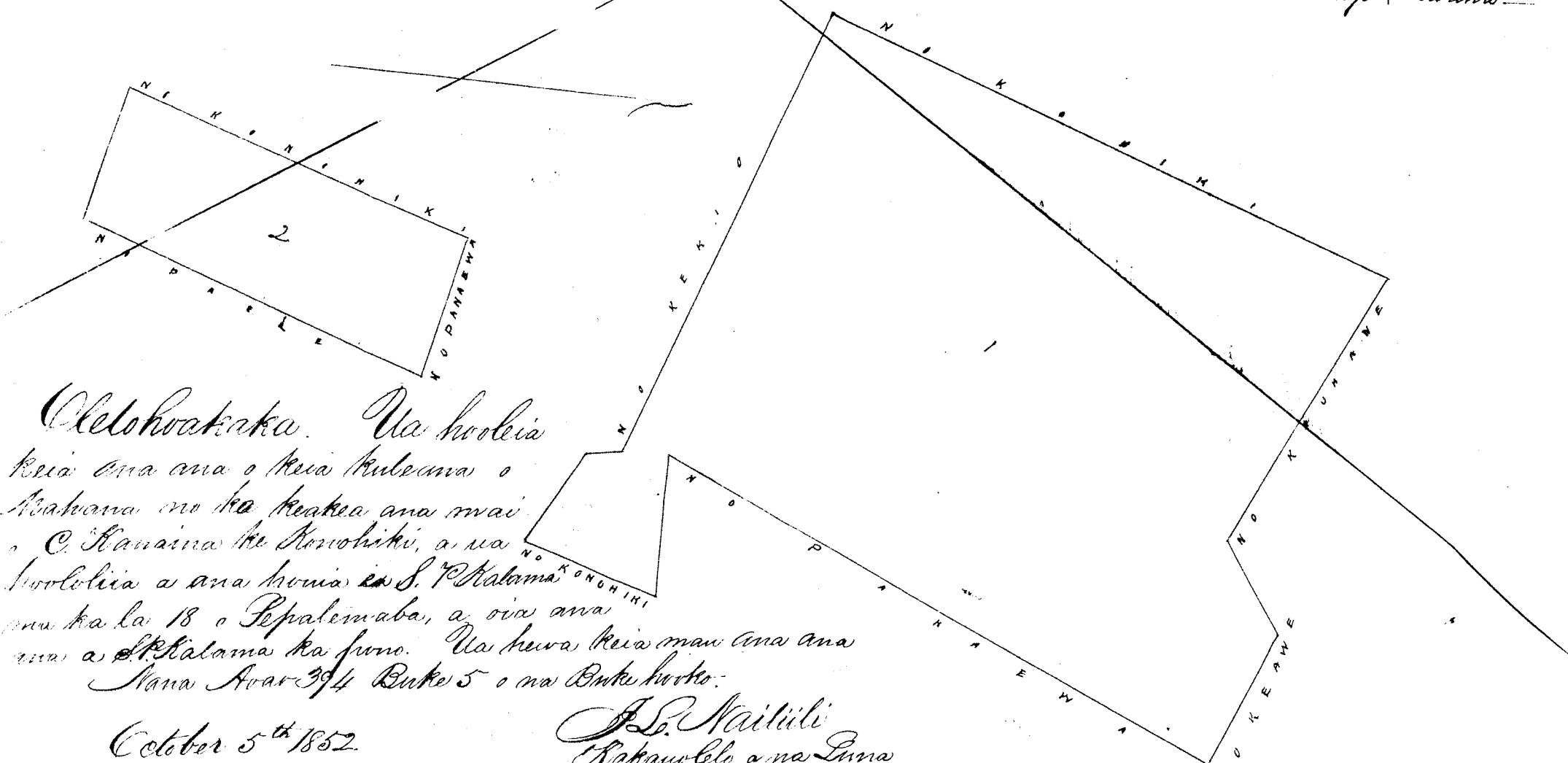

Ua hooleia
 Keia ana ana o Keia Kuleana o
 Moahana no ka keia ana mai
 o C. Hanaina ke Honolulu, a ua
 hooleia a ana houna o S. P. Malama
 ana ka la 18 o Pepalemaba, a oia ana
 ana a S. P. Malama ka fono. Ua hewa keia ana ana
 ana Awar 39 1/4 Buke 5 o na Buke hoko:

October 5th 1852

J. S. Kaitiuli
Kakawelo a na Lina

Uku Pau Loa \$
Uku
9.

Honolulu Julai 5 1852

Hulu 1430 Huikau mo Kaiwi Hooolina

Waikiki Oahu

Huikau make Kaiwi Kaitiamakine Hooolina
 E hulu i loko o ka ili o Kamookahi Waikiki Oahu E hoomaka ma ke kiki Hele ana AK 42°
 Hem i 160 Ah ma ka palena o Honolulu malaila aku hem 48° Hem i 730 Ah ma ka palena o Hele
 Kai malaila aku hem 43° Hiki i 160 Ah ma ka palena o Honolulu malaila aku AK 48° Hiki 730
 Ah ma ka palena o Honolulu a hiki i ka hoomaka ana 1 Eka 1 68/100 Ah huinaha

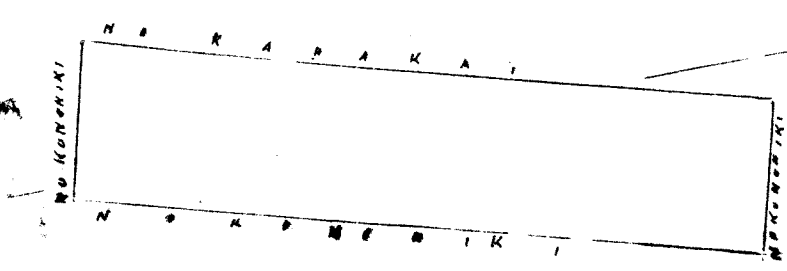

A Bishop
Ma ana

0 0 3 0

Wku Pau Loa \$5.00

G. M. Robertson
J. H. Smith
J. Kekaulahao

Honolulu June 25 1852

Heleu 2085 Heamalu Hooina Unuanu

Waikiki Oahu

Heamalu Part 2,

See Page 413-13. Awards Books

1. Loi, me Ka aiiwai, i loko. Kamookahi, Waikiki, Oahu.
E hoomaka ma Ke Pihikama, e hile ana, Ak 45; Hiki, i 126, Ak, ma Ka palena me Kaunani, malaila aku, Ak 45; Hom, 126, Ak, ma Ka palena me Pahu, malaila aku, Hom 45; Hom, i 126, Ak, ma Ka palena me Kahana, malaila aku, Hom 45; Hiki, i 126, Ak, ma Ka palena me Kuuwa, a hiki i Ka hoomaka ana, 1. 3/100, Ak, huihana.

A. Bishop, Mea ana,

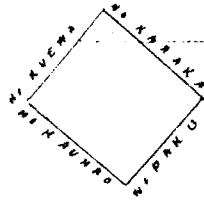

Wku Pau Loa \$3.00

G. M. Robertson

J. H. Smith

Honolulu July 5 1852

Heleu 1303 Kukeamenuu

Palolo Oahu

Kukeamenuu,

Mo Ka huihaukapa, S. Loi, i loko. Kapulu, Palolo Oahu.

E hoomaka ma Ke Pihikama, e hile ana, Ak 34; Hom, i 450, Ak, ma Ka palena me Makas, malaila aku, Ak 50; Hiki, i 172, Ak, malaila aku, Hom 62; Hiki, i 100, Ak, malaila aku, Hom 17 1/2; Hiki, i 270, Ak, ma Ka palena me Konoiki, malaila aku, Hom 51; Hom, i 170, Ak, a hiki i Ka hoomaka ana, Ak 9, Ak, huihana.

A. Bishop, Mea ana,

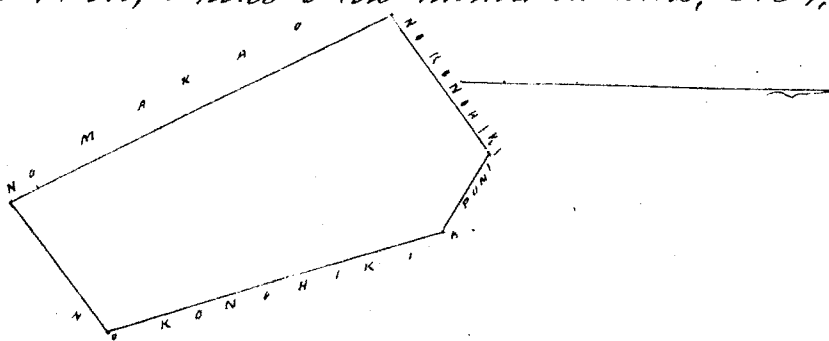

Wku Pau Loa \$ 5.00

W. H. Hui

J. H. Smith

G. M. Robertson

Honolulu July 5 1852

Heleu 1304 Keawekoloua

J. Kekaulahao

Palolo Oahu

Keawekoloua,

meo aima o Puhaitilata, i loko. Wailupe, Palolo, Oahu

E hoomaka ma Ke Pihikama e hile ana Akau i 255 Ak ma Ka palena me Konoiki malaila aku Ak 46 1/2 Hiki 273 Ak ma Ka palena o Puhaitilata, malaila aku Hom 45; Hiki 55 Ak ma Ka palena me Konoiki malaila aku Hom 65; Hom i 500 Ak ma Ka palena Kula o Konoiki a hiki i Ka hoomaka ana o Eka malalo

A. Bishop Mea ana

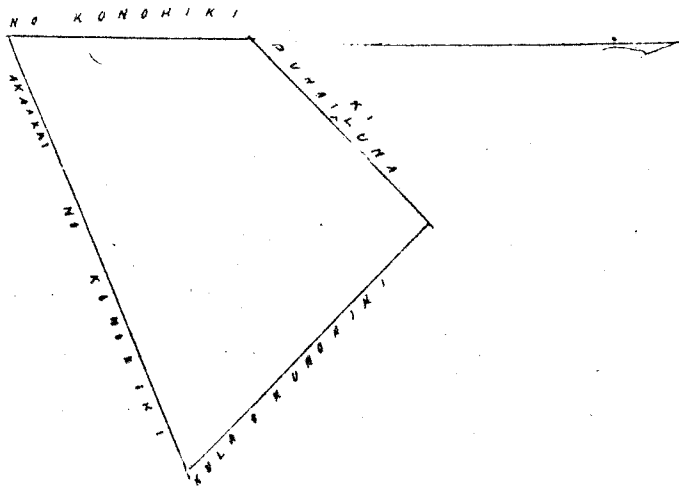

Uku Pau Loa \$ 6.00

Makae

G. M. Robertson

J. H. Smith

Honolulu Julai 5 1852

J. Kamaulahas

Hele 1413 Hooakaamomi

Waikaha Oahu Ewa

Hooakaamomi

Apana 1 He pahale i loko ke Kula. Anali Waikaha
Ua hookeia keia wahi e kaholo nona ke Kula
E hoomaka ana ke Pihikahi Komohana nona e hiki ana i Ak 5° Hiki i 176 Kk ma ka aao. ka paalua 2 Ak 6° Hiki i
308 Kk ma ka aao. ke Kula. Kaholo 3 Ak 30° Kom i 197 Kk ma ka aao. ke Kula. Kaholo 4 Ak 60° Kom 230 Kk
ma ka aao. ke Kula. Kaholo inalaki. keia pahale he 598 Kk huinahalike

Apana 2 He moaaina (Mikiokai ili) ke Ahupuaa Waikaha E. C.
E hoomaka ana ke Pihikahi Akau a e hiki 1 Ak 65° Kom i 113 Kk ma ka palena aina. Makue 2 Ak 20° Hiki i
10 Kk ma ka palena aina. Kaouliokama 3 Ak 70° Kom i 018 Kk ma ka palena aina. Kaouliokama
Ak 7° Hiki i 177 Kk ma ka palena aina. Kaouliokama 5 Ak 72° Kom i 177 Kk ma ka palena aina.
Kaouliokama 6 Ak 17° Hiki i 161 Kk ma ka palena aina. Kaouliokama 7 Ak 15° Kom 074 Kk ma
ka palena aina. Kaouliokama 8 Ak 52° Hiki i 335 Kk ma ka palena aina. Kaouliokama 9 Ak 50° Hiki i
171 Kk ma ka palena aina. Kaouliokama 10 Ak 6° Hiki i 113 Kk ma ka palena. Makue 11 Komohana
064 Kk ma ka palena. Makue 12 Ak 28° Kom i 333 Kk ma ka palena. Makue 13 Ak 66° Hiki i
405 Kk ma ka palena. Makue 14 Ak 30° Kom i 320 Kk ma ka palena aina. Makue Malaki.
Keia Apana e lua he 2 Eka me 003 Kk huinahalike

A Bishop Mea ana

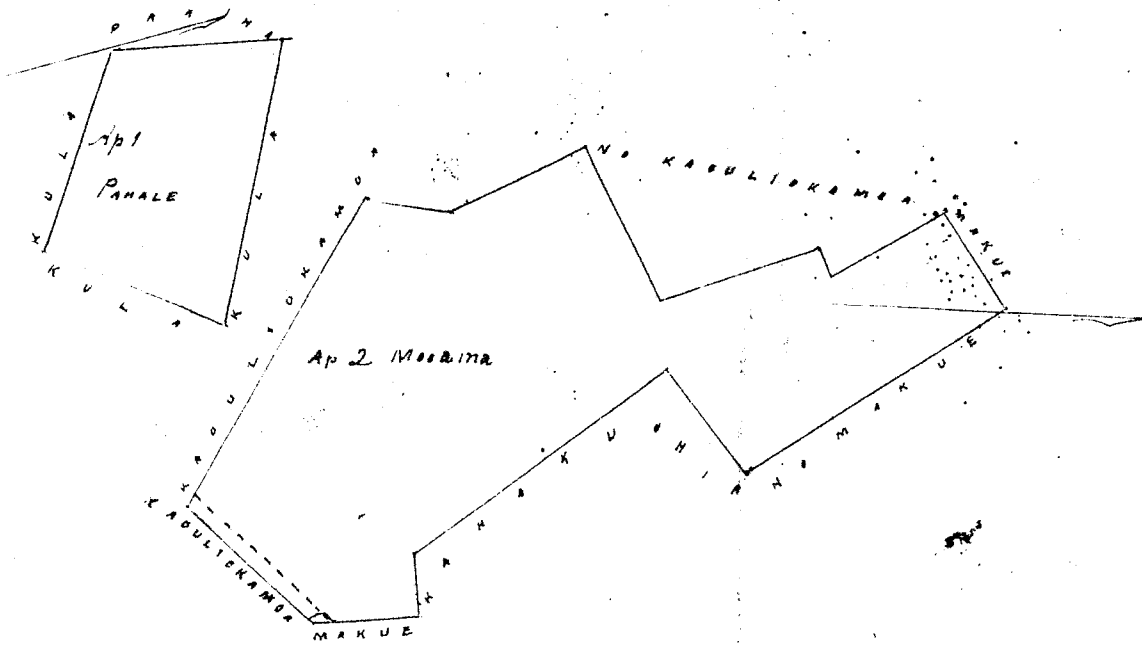

Uku Pau Loa \$ 6.00

Makae

G. M. Robertson

J. H. Smith

Honolulu Julai 5 1852

J. Kamaulahas

Hele 1446 Naa

Waikiki Oahu

Apana 1 He Pahale i loko ke Ahupuaa Waikiki Oahu
E hoomaka ana ke Pihikahi Kihina e hiki ana Ak 40 Kom i 080 Kk ma ka palena on Komohiki Malaila aku
Kom 50° Kom i 350 Kk ma ka palena on Palauale Malaila aku Kom 40° Hiki i 080 Kk ma ka palena Malaila
aku Ak 50 Hiki 350 Kk ma ka Komohiki a hiki i ka hoomaka ana he 2 80/100 Kk huinaha

A Bishop

Mea ana

see page 639

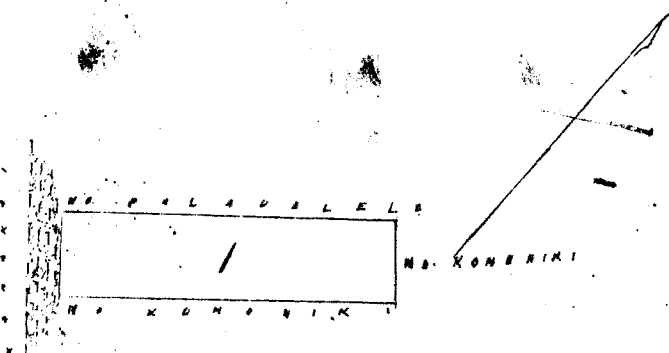

Uku Pan Loa # 4. 00

G. M. Robertson

J. H. Smith

Honolulu Iulai 5 1852

J. Kekaulahao

Hele 1646 Louahiwa or Kaulahiwa

Pablo Oahu

Ke Mo Kalo, Kaiahole ili, Kapahulu Palolo Oahu

E hoomaka ma Ke Kahi Komoana Koma e hule ana kem 74° Nih i 140 Kk ma Ka palena no Upupe Malaila aku AK 19° Nih i 275 Kk ma Ke Konoiki Malaila aku AK 62° kem i 277 Kk ma Ke Konoiki Malaila aku AK 10° Nih i 25 Kk Malaila aku AK 82 1/2° kem i 330 Kk ma Ka palena no Pehina Malaila aku kem 6 1/2° kem i 200 Kk ma Kahawai Malaila aku kem 72 1/2° Nih i 323 Kk ma Ka palena no Nahale Malaila aku AK 30° Nih i 070 Kk Malaila aku kem 72° Nih i 160 Kk ma Ka palena no Kele Malaila aku kem 9° kem i 200 Kk a hiki i Ka hoomaka ana 1 Eka i 24/100 Kk huinaha

Apana 2. Pahale: Keahua Kapahulu

E hoomaka ma Ke Kahi Komoana e hule ana AK 21° Nih i 160 Kk ma Ka palena Kula. Konoiki Malaila aku kem 66° Nih i 220 Kk ma Ka pa o Mahana Malaila aku kem 27 1/2° kem i 160 Kk ma Ka palena no Konauma Malaila aku AK 61° kem i 220 Kk ma Ka palena no Kuluhihuli a hiki i Ka hoomaka ana 3 5/100 Kk huinaha
Pan Loa 1 Eka 4 56/100 Kk huinaha

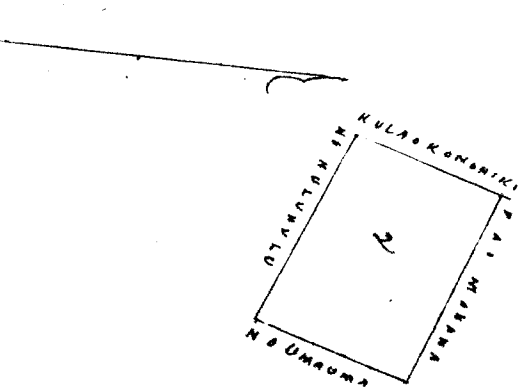
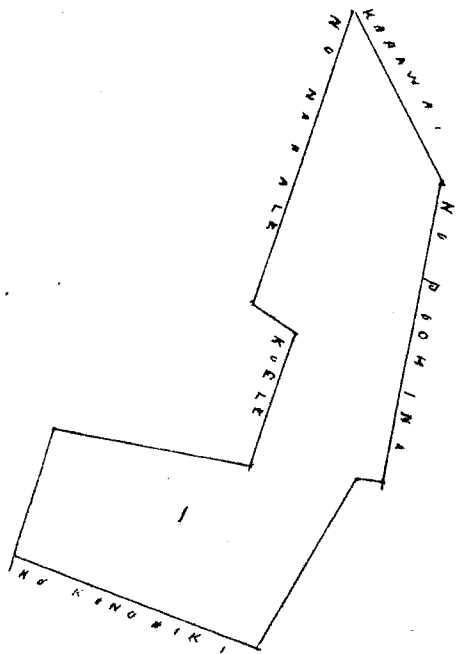

A Bishop Meana

Uku Pan Loa # 6

W. H. P. H.
G. M. Robertson
J. H. Smith

Honolulu Iulai 5 1852

J. Kekaulahao

Hele 1308 Kaula

Pablo Oahu

Ke mo aino o Puhalahua ili, Kapahulu Palolo Oahu

E hoomaka ma Ke Kahi Komoana e hule ana kem 65° Nih i 867 Kk ma Ka palena no Manamana Malaila aku AK 10° Nih i 200 Kk ma Ka palena no Konoiki Malaila aku AK 50° kem i 200 Kk ma Ka palena no Kaaunawaia Malaila aku kem 30 1/2° kem i 070 Kk ma Ka palena no Kele Malaila aku AK 46° kem i 174 Kk Malaila aku AK 56 1/2° Nih i 070 Kk Malaila aku AK 48 1/2° kem i 473 Kk ma Ka palena no Kaaunawaia Malaila aku kem 7° kem i 445 Kk a hiki i Ka hoomaka ana 2 Eka 22 1/100 Kk huinaha

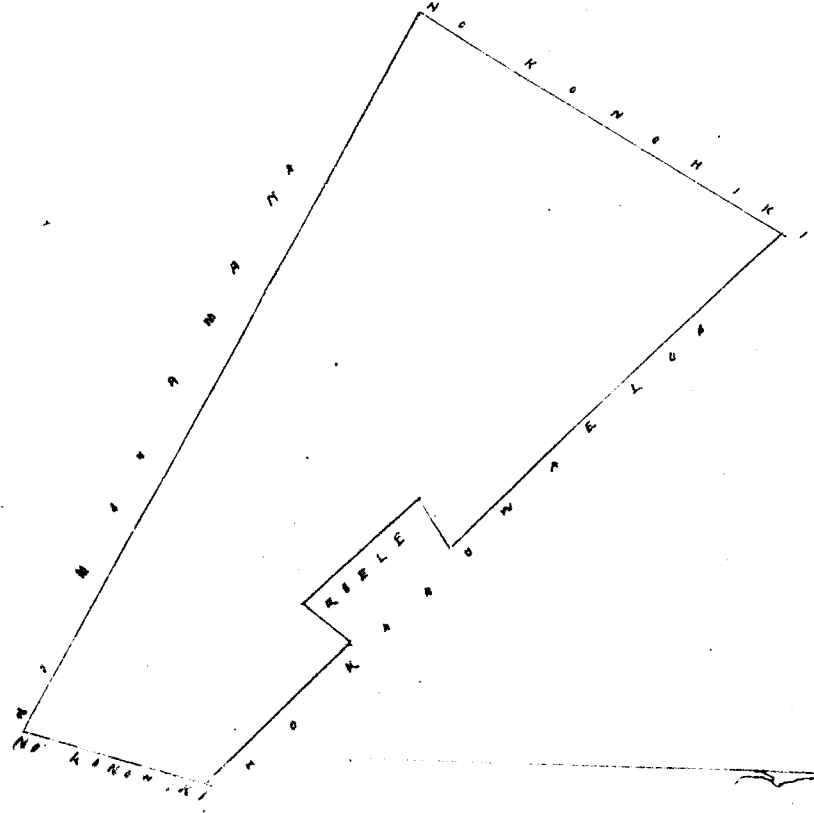

A Bishop Meana

Wm. Pau Loa # 6

W. H. K.
G. M. Robertson
J. H. Smith

Honolulu Iulai 5 1852

J. Kekaulahas

Helu 1897 Okule

Palolo Waikiki Oahu

Apana 1 He Pahale ana Hanohuku Palolo Waikiki Oahu
E hoomaka ma ke Pihiki Hikina e hele ana AK 69° Kom i 200 Kk ma ka palena Kula mo Hanohuku Malaila aku
Kom 21° Kom 170 Kk Malaila aku, Kom 69° Kik i 200 Kk ma ka palena Kula mo Hanohuku Malaila aku
AK 21° Kik i 170 Kk a hiki i ka hoomaka ana He 3 40/100 Kk huinaha

Apana 2, He moe Pooiki Ohi. Kikio Palolo Waikiki Oahu
E hoomaka ma ke Pihiki Hikina e hele ana Kom 23° Kom i 200 Kk ma ke Kahawai Malaila aku Kom 63°
Kom i 260 Kk ma Kahawai Malaila aku, AK 22° Kom i 120 Kk ma ka palena mo Kapuni Malaila aku
AK 82° Kik i 220 Kk ma ke Hanohuku Malaila aku, AK 30° Kom i 260 Kk ma ka palena mo Kawaihae Malaila
aku, AK 70° Kik i 170 Kk ma ka palena mo Kawaihae Malaila aku Kom 30° Kik i 118 Kk ma ka palena
Hanohuku Malaila aku, Kom 62° Kik i 550 Kk a hiki i ka hoomaka ana He 6 22/100 Kk huinaha Pau Loa
9 92/100 Kk huinaha

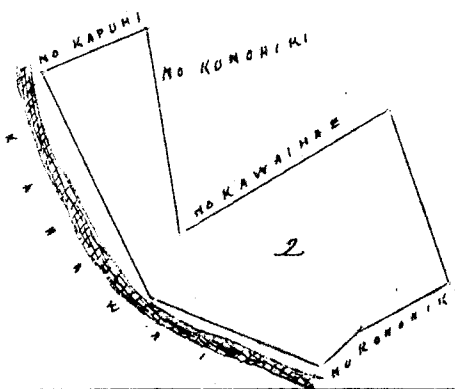
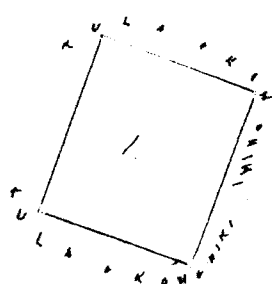

A. Bishop
Mea ana

Wm. Pau Loa # 4

W. H. K.
G. M. Robertson
J. Kekaulahas
J. H. Smith

Honolulu Iulai 5, 1852

Helu 1650 Hoapali

Palolo Waikiki Oahu

He moe aina i loko ka ili o Kaula Palolo Oahu
E hoomaka ma ke Pihiki Hikina e hele ana, AK 19 1/2° Kik i 400 Kk, ma ka palena Kula, Malaila aku,
AK 57° Kom i 321 Kk, ma ka palena mo Hanohuku Malaila aku, Kom 57° Kik i 508 Kk, ma ke Hanohuku
malaila aku, Kom 57° Kik i 115 Kk, a hiki i ka hoomaka ana, He 8 85/100 Kk huinaha,

A. Bishop, Mea ana,

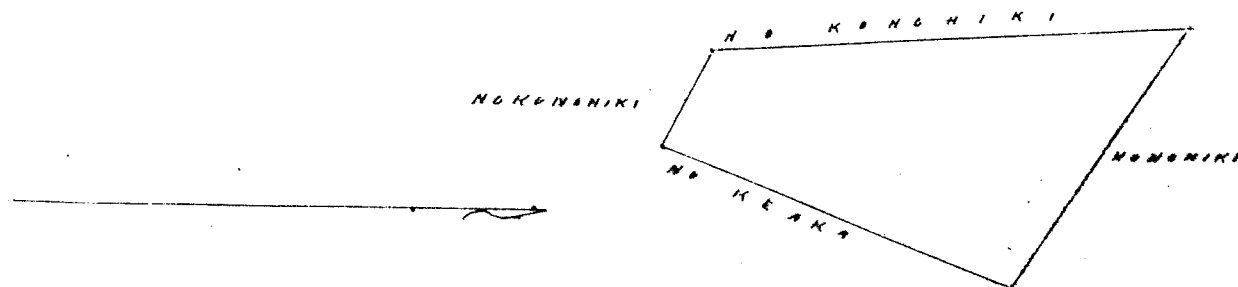

Wm. Pau Loa #

W. H. K.
G. M. Robertson
J. H. Smith

Honolulu Iulai 5 1852

J. Kekaulahas

Helu 1656 Upepe

Palolo Oahu

He moe aina Kaulaaha ili. Kikio Palolo Oahu
E hoomaka ma ke Pihiki Hanohuku e hele ana, AK 22° Kik i 300 Kk ma ka palena mo Hanohuku
Malaila aku AK 53° Kom i 550 Kk Malaila aku AK 42° Kik i 380 Kk ma ka palena mo Kapuni
Malaila aku, Kom 57° Kik i 180 Kk ma ka palena mo Mea Malaila aku Kom 15° Kom 150 Kk
ma ka palena mo Hanohuku Malaila aku, AK 62° Kom i 345 Kk a hiki i ka hoomaka ana

2 Eka 1¹/₁₀₀ Kk huinaha

Apana o Ke Kahuahale Kauhahaia ili. Keki Palolo
E hoomaka ma Ke Kiki Akau e huli ana kem 61° NKK 100 Kk ma Ke palena ma Hale Malaila aku
kem 61° NKK 150 Kk ma Ke palena ma Kuaana Malaila aku AK 24 1/2 NKK 100 Kk Malaila aku
AK 61° Kom 150 Kk a hiki i Ke hoomaka ana 150/100 Kk huinaha
Aui Pau loa 2 Eka 26/100 Kk huinaha

A Bishop
Mea ana

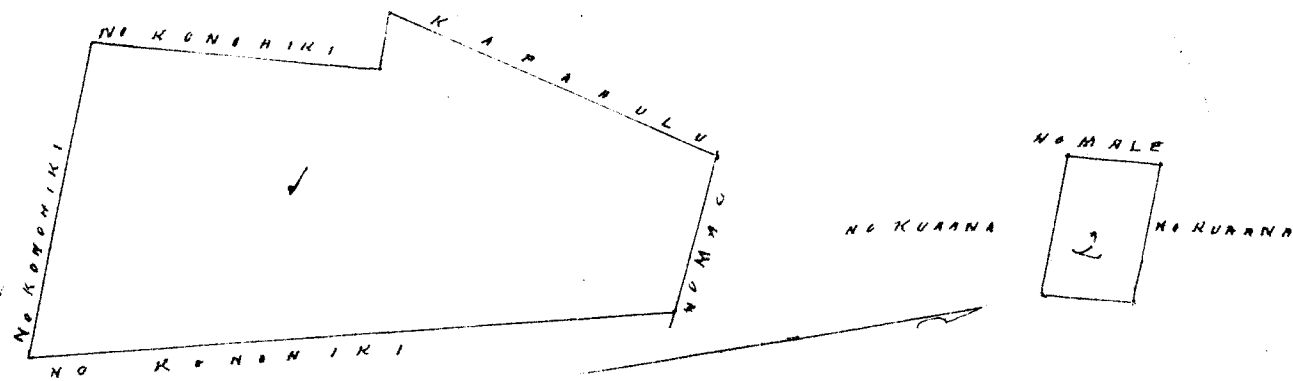

Wku Pau Loa \$ 7.00
W. H. H. H.
G. M. Robertson
J. H. Smith
J. Kekaulaha

Honolulu June 25 1852

Feb 1868 Kona

Palolo Oahu

Noo aina o Launi ili. Kapahulu Palolo Oahu
E hoomaka ma Ke Kiki Kikina e huli ana AK 55° Kom 125 Kk ma Ke palena ma Kahala Malaila aku
kem 31° Kom 080 Kk ma Ke palena Kule Malaila aku, AK 58° Kom 154 Kk Malaila aku AK
32 1/2 NKK 090 Kk ma Ke palena Kule Malaila aku, AK 62° Kom 1048 Kk ma Ke Kahala
Malaila aku kem 24° Kom 410 Kk ma Kahawai Malaila aku, kem 63° NKK 300 Kk ma Ke palena
ma no Konoiki Malaila aku AK 25° NKK 310 Kk ma Ke palena ma Paalea a hiki i Ke hoomaka
ana 1 Eka 1¹⁴/₁₀₀ Kk huinaha

A Bishop
Mea ana

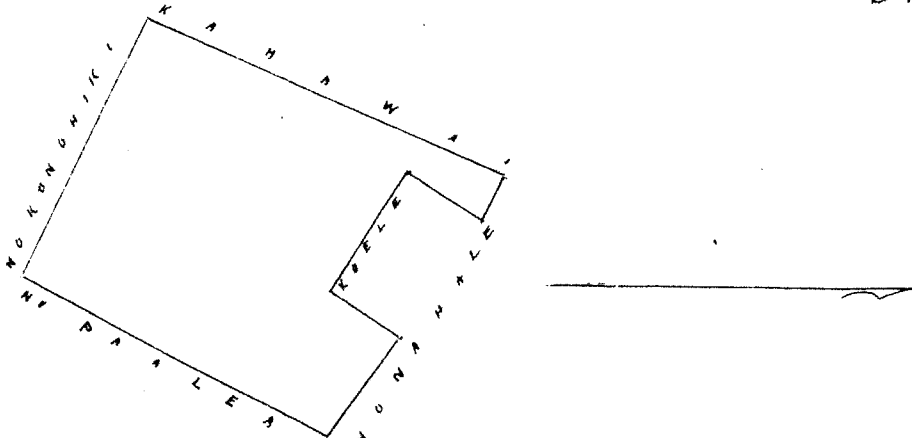

Wku Pau Loa \$ 6.00
W. H. H. H.
G. M. Robertson
J. H. Smith

Honolulu June 25 1852

J. Kekaulaha

Palolo Waikiki Oahu

Ke moe aina i loko. Ke ili o Waialae, Palolo, Oahu
E hoomaka ma Ke Kiki Konoheana ma Ke pa aina o Wilama e huli ana, AK 46° NKK 175 Kk ma Ke palena
Kula o Waialae Malaila aku kem 49° NKK 284 Kk ma Ke palena ma Amala Malaila aku
kem 48° Kom 200 Kk ma Ke palena Kule Malaila aku, kem 47 1/2 NKK 100 Kk ma Ke pa
aina Malaila aku AK 47° NKK 200 Kk ma Ke palena Kule Malaila aku, kem 49° NKK 474
Kk ma Ke palena ma Amala Malaila aku, kem 38° Kom 200 Kk ma Kahawai malaila
aku AK 47° Kom 900 Kk ma Ke pa aina o Wilama a hiki i Ke hoomaka ana 1 Eka
58 3/100 Kk huinaha

A Bishop
Mea ana

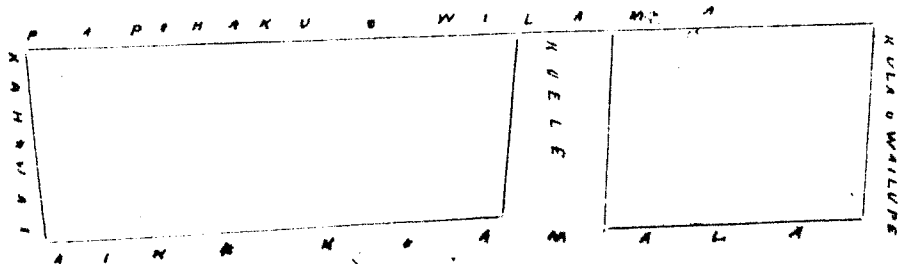

Wai Pau Loa \$ 6.00

W. H. W. H.
G. M. Robertson
J. H. Smith

Honolulu Iulai 5 1852

J. Kekaulahao

Hulu 1855 Kailanapule

Palolo Oahu

Moo, Kalo, Kapakahu, Palolo, Oahu

E hoomaka ma Ke Kiki Nema, e hula ana, AK 23' Hiki i 0 90, Ah, ma ka palena o Kekio, Malaila aku, AK 70' Hom i 175 Ah ma Ke Konoiki Malaila aku, AK 6' Hiki i 100 Ah Malaila aku, AK 77' Hom i 335 Ah ma ka palena o Kaunani Malaila aku Hom 24' Hom i 184 Ah ma Kahuwai Malaila aku Hom 73' Hiki i 55 Ah ma ka palena o Konoiki a hiki i ka hoomaka ana He 8 84/100 Ah huinaha

Apana 2 Kahuwai ma Kapa Kapakahu Palolo

E hoomaka ma Ke Kiki Kikina e hula ana Hom 35' Hom i 162 Ah ma ka palena o Kekio Malaila aku AK 60' Hom i 250 Ah ma ka palena o Kahuwai Malaila aku AK 27' Hiki i 157 Ah ma Kula, Konoiki Malaila aku, Hom 63' Hiki i 250 Ah ma ka palena o Konoiki a hiki i ka hoomaka ana He 3 25/100 Ah huinaha Hei pau loa 1 Eka 2 39/100 Ah huinaha A Bishop Mea ana

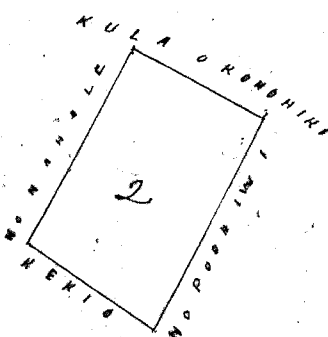
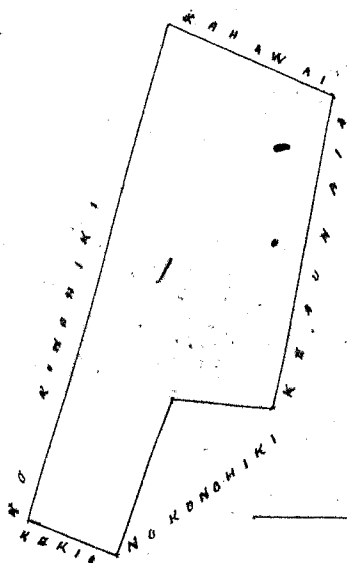

Wai Pau Loa \$ 6.00

W. H. W. H.
G. M. Robertson
J. H. Smith

Honolulu Iulai 5 1852

J. Kekaulahao

Hulu 1858 Kahuwai Kahuwai Kahuwai

Palolo Oahu

Kahuwai, Kahuwai, Kahuwai

E Kolu Iui me Kula, i loko o Kekio, Palolo, Oahu, E hoomaka ma Ke Kiki Nema, e hula ana, AK 19' Hiki i 100 Ah ma ka palena o Kahuwai Malaila aku, AK 70' Hom i 438 Ah ma ka palena o Konoiki Malaila aku Hom 184' Hom i 117 Ah ma ka palena o Kahuwai Malaila aku Hom 80 1/2' Hiki i 438 Ah ma ka palena o Konoiki a hiki i ka hoomaka ana He 4 52/100 Ah huinaha A Bishop Mea ana

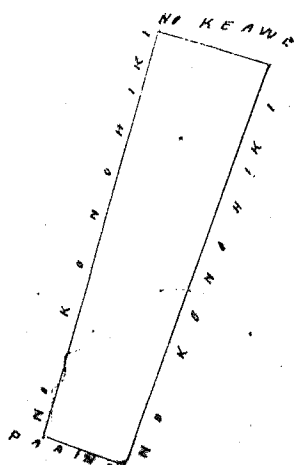

Wai Pau Loa \$ 5.00

W. H. W. H.
G. M. Robertson
J. H. Smith
J. Kekaulahao

Honolulu Iulai 5 1852

Heleu 1873 Hamano

Palolo Oahu

Apawa 1 Mo Apawa 2 i loko o Kapahulu Palolo Oahu

E hoomaka ma ke Piki Akau e hulu ana Stem 22° Nomi 160 Kk ma ka palena Mole Malaila aku Stem 74 Niki 425 Kk ma ka palena no Pookini Malaila aku, Ak 9, Niki i 123 Kk ma ka palena no Hawaii, Malaila aku, Ak 77 Nomi i 400 Kk ma ka palena no Honolulu a hiki i ka hoomaka ana Ak 4 54/100 Kk huinaha

Apawa 2 Kahuahale ma Keahua Kapahulu

E hoomaka ma ke Piki Akau, e hulu ana Stem 70° Niki i 135 Kk ma ka palena Kupapau Malaila aku, Stem 30° Nomi i 150 Kk ma ka palena o Kekio Malaila aku, Ak 58° Nomi 110 Kk ma ka palena o Pookini Malaila aku Ak 21 Niki i 120 Kk ma ka palena a hiki i ka hoomaka ana Ak 79/100 Kk huinaha Nui pau Loa 5 63/100 Kk huinaha

A. Bishop
Mee ana

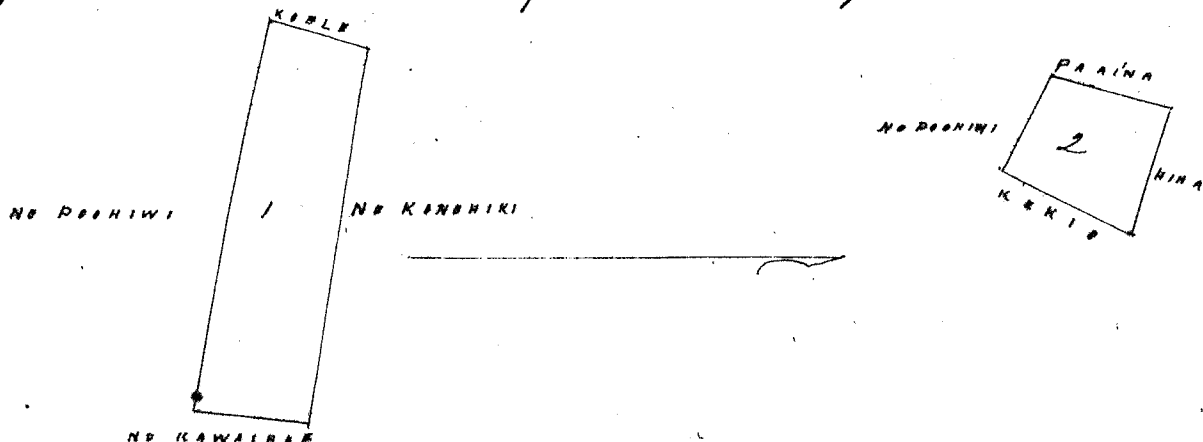

Ukupau Loa # 5.00

M. H. H.

G. M. Robertson

J. Kekaulaha

J. H. Smith

Honolulu Iulai 5 1852

Heleu 1887 Koukukulu

Palolo Oahu

Apawa 1 Mo aina i loko o Kapahulu Palolo Waikiki

E hoomaka ma ke Piki Niihama e hulu ana, Stem 19° Nomi i 175 Kk ma ka palena o Kekio Malaila aku, Ak 65° Nomi i 150 Kk ma ka palena no Upepe Malaila aku, Ak 12° Niki i 147 Kk ma ka palena no Honolulu Malaila aku, Stem 76° Niki i 110 Kk ma ka palena no Hamano a hiki i ka hoomaka ana 2 64/100 Kk huinaha

Apawa 2 Kahuahale ma Kula o Kapahulu Palolo

E hoomaka ma ke Piki Niihama e hulu ana Ak 61° Nomi i 180 ma ka palena hale o Inahe Malaila aku, Stem 22° Nomi i 200 Kk ma ka palena o Honolulu Malaila aku Stem 64° Niki i 170 Kk ma ka palena Kupapau, Malaila aku Ak 21 Niki i 170 Kk ma ka palena o Kekio a hiki i ka hoomaka ana Ak 35 2/100 Kk huinaha Nui pau loa 6 7/100 Kk huinaha

A. Bishop
Mee ana,

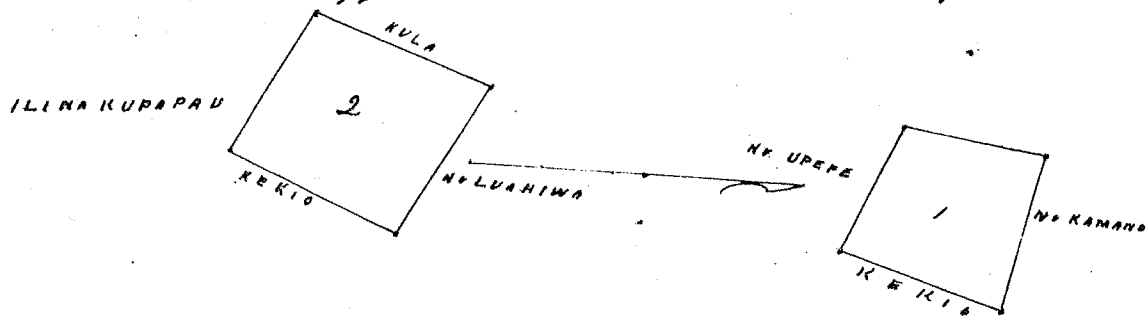

Ukupau Loa # 5

M. H. H.

G. M. Robertson

J. H. Smith

Honolulu Iulai 5 1852

Heleu 1863 Keaka

Waikiki Oahu

Ehua Ioi i loko o Piliama Waikiki Oahu

E hoomaka ana ma ke Piki Nema e hulu Ak 50° Nomi i 112 Kk ma ka palena no Kalawa, Malaila aku, Ak 24° Niki i 030 Kk malaila aku Ak 65° Nomi i 10 Kk ma ka palena no Pookini malaila aku, Ak 40 Niki i 110 Kk ma ka palena no Pookini malaila aku, Stem 37° Nomi i 190 Kk ma ka palena no Iona a hiki i ka hoomaka ana 4 7/100 Kk huinaha

A. Bishop
Mee ana

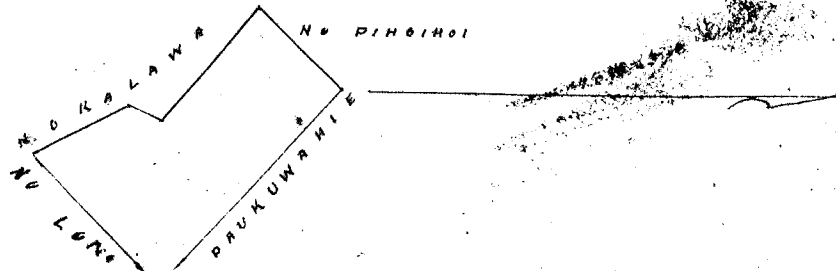

Wm Pau Loa \$6.00

J. H. Smith
G. M. Robertson
J. Kekaulahao

Honolulu Julai 5 1852

Hele 2126 Heahe Hea Kahakalo i Waitiki Oahu

He pahale ma Keomukukai Waitiki Oahu
E hoomaka ma Ke Kiki Komohana e hile ana AK 24° Niki i 148 Ah ma ka palena Pahale, Kanae Malaila
aku Hem 65° Niki i 048 Ah ma ka palena Kelumoa Malaila aku Hem 24° Kom 148 Ah ma ka palena
hale. Ku, Malaila aku AK 65° Kom i 048 Ah ma Kahakalo a hiki i ka hoomaka ana He 7/100
Ah huihaha
A Bishop Mea ana



Wm Pau Loa \$4.00

W. H. H. H.
G. M. Robertson
J. Kekaulahao
J. H. Smith

Honolulu Julai 5 1852

Hele 1898 Opunui (no Kahakalo Hoolina) Palolo Oahu
Opunui Hoopii Kahakalo Hoolina

Apana 1. He Pahale i Kahuahau Ili, Waiomas Palolo Oahu
E hoomaka ma Ke Kiki Komohana e hile ana Hem 40 Niki i 200 Ah ma ka palena no Pa. Malaila
aku, AK 84° Niki i 224 Ah ma ka palena no Kaala Malaila aku, AK 40° Kom i 200 Ah Malaila
aku, Hem 84° Kom 224 Ah ma ka palena no Kiuwa a hiki i ka hoomaka ana He 4 4/100 Ah huihaha

Apana 2, 3 Ii i Makapua Ili o Waiomas Palolo
E hoomaka ma Ke Kiki Kama e hile ana AK 35° Kom i 150 Ah ma ka palena no Konoiki Malaila
aku, AK 60° Niki i 348 Malaila aku, Hem 35° Niki i 145 Ah ma ka Konoiki Malaila aku Hem 46°
Kom i 440 Ah ma Kahawai a hiki i ka hoomaka ana He 5 2/100 Ah huihaha

Apana 3, 1 Ii i Iki o Waiomas
E hoomaka ma Ke Kiki Komohana e hile ana Hem 32° Niki i 126 Ah ma ka palena no Kono-
hiki Malaila aku, AK 46° Niki i 460 Ah ma ka palena no Kiuwa Malaila aku, Hem 32°
Kom i 450 Ah a hiki i ka hoomaka ana, He 2 8/100 Ah huihaha Wm Pau Loa \$6.00
A Bishop
Mea ana

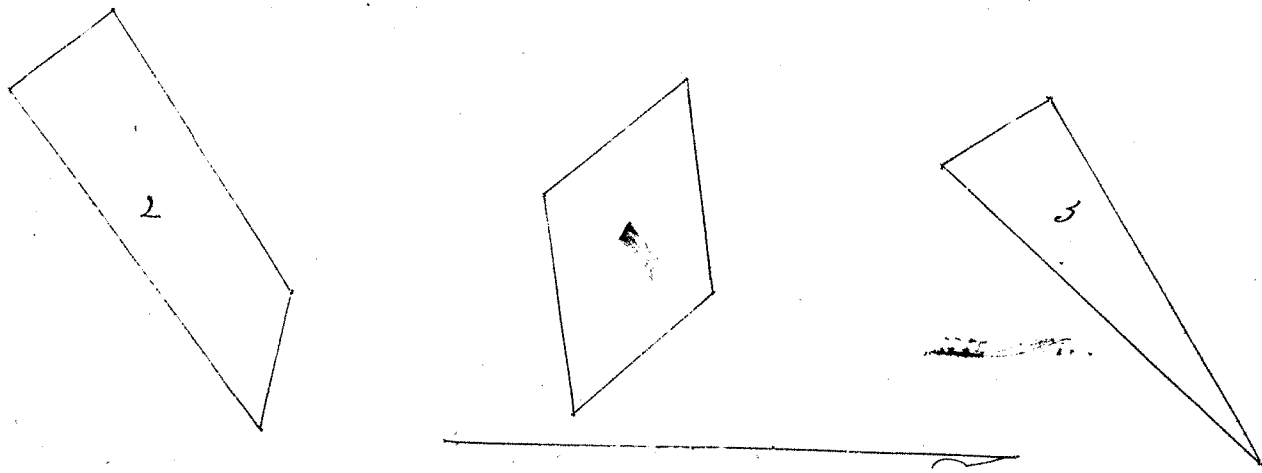

Wm Pau Loa \$6.00

G. M. Robertson
J. H. Smith
J. Kekaulahao

Honolulu July 5 1852

Hoenu 1302 Hoenu

Waikiki Oahu

41

2 Loi i loko Kihī Waikiki Oahu
E hoomaka ma ke Kihī Komohana e hili ana Am 49° Niki i 075 Ah ma ka palena no Kamaka Malaila ahu
Am 43° Niki i 174 Ah ma ka palena no Kapawa malaila ahu, Am 49° Niki i 074 Ah ma ka palena no
Kamaka Malaila ahu, Am 43° Niki i 114 Ah ma ka palena no Paakea, a hiki i ka hoomaka ana
130/100 Ah huinaha

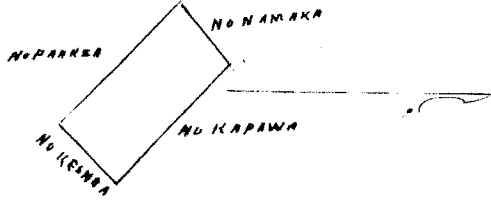

A Bishop
Mea ana

Uku Pau Loa \$4.00

W. Lee

J. H. Smith
G. M. Robertson

Honolulu Iulai 5 1852

J. Kikaulaao

Hoenu 1380 Kakaakeo

Waikiki Oahu

Ke Kula i loko Keomukuu i Kai Waikiki Oahu
E hoomaka ma ke Kihī e Kahu e hili ana, Am 42° Niki i 350 Ah ma ka palena no Kakaakeo Malaila
ahu, Am 34° Niki i 473 Ah ma ka palena no Kakaakeo Malaila ahu, Am 33° Niki i 155 Ah ma ka palena
Malaila ahu, Am 30° Niki i 180 Ah ma ka palena no C. R. Bishop Malaila ahu, Am 46° Niki i 260 Ah ma
ka palena no C. R. Bishop a hiki i ka hoomaka ana, 1 Eka 9 85/100 Ah huinaha

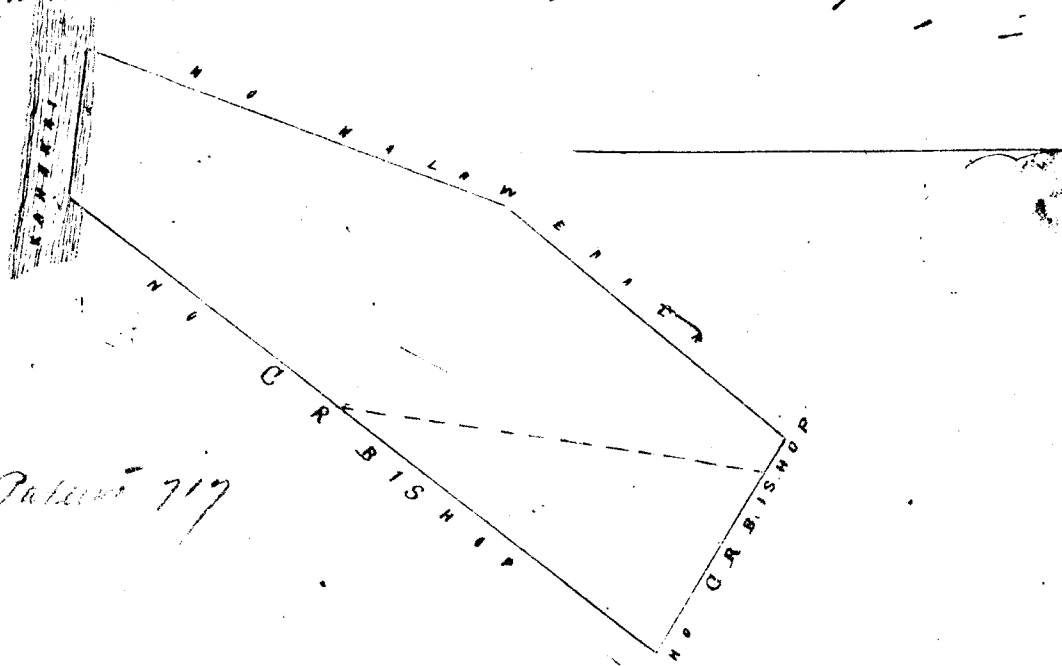

A Bishop
Mea ana

2 Apana
See original papers + Patent 717
C.H.

Uku Pau Loa \$6.00

J. H. Smith
G. M. Robertson

Honolulu Iulai 5th 1852

J. Kikaulaao

Hoenu 8290 Keimoua

Palolo Oahu

2 Apana i ka moe Kakaakeo i loko Waimea Palolo Oahu
E hoomaka ma ke Kihī e Kahu e hili ana Am 23° Niki i 030 Ah Malaila ahu, Am 49° Niki i 548 Ah ma ka
palena no Keimoua Malaila ahu, Am 31° Niki i 030 Ah Malaila ahu, Am 49° Niki i 548 Ah ma ka palena
a hiki i ka hoomaka ana, 1 Eka 1 24/100 Ah huinaha

Apana 2, Keipahale i loko Waimea Palolo
E hoomaka ma ke Kihī Komohana e hili ana Am 32° Niki i 333 Ah ma ka palena no Keimoua Malaila
ahu, Am 27° Niki i 333 Ah ma ke Keimoua Malaila ahu, Am 32° Niki i 333 Ah Malaila ahu Am
27° Niki i 333 Ah ma ke Keimoua a hiki i ka hoomaka ana 1 Eka 78/100 Ah huinaha Uku Pau Loa 1 Eka 1 24/100
Ah huinaha

A Bishop
Mea ana

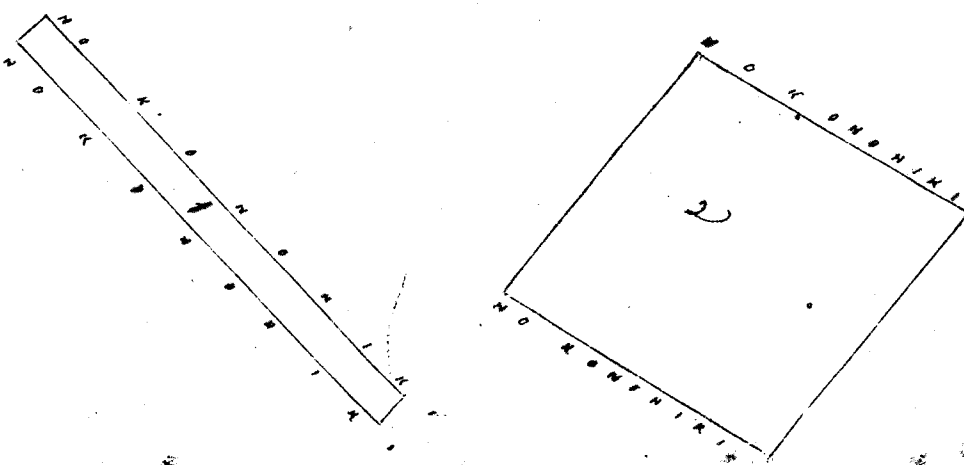

Uku Pau Loa \$6.00
 W. H. Lee
 J. H. Smith
 G. M. Robertson

Honolulu July 5 1852 J. Kekaulaao
 Hele 8287 Koa-wainuu

Palolo Oahu

Ma mo aina Kamakaha ili. Waiomas Palolo Oahu
 E hoomaka ana ke Piki Hikiina e hui ana AK 47° Kom i 140 Kh ma ka palena o Konoiki
 Mabaila aku Kom 40 1/2° Kom i 350 Kh ma ka Konoiki Mabaila aku Kom 25° Kom i 150 Kh ma
 baila aku Kom 89 1/2° Hiki i 222 Kh ma ka palena o Konoiki Mabaila aku AK 49 1/2° Hiki
 i 350 Kh a hiki i ka hoomaka ana, He 840.00 Kh huinaha

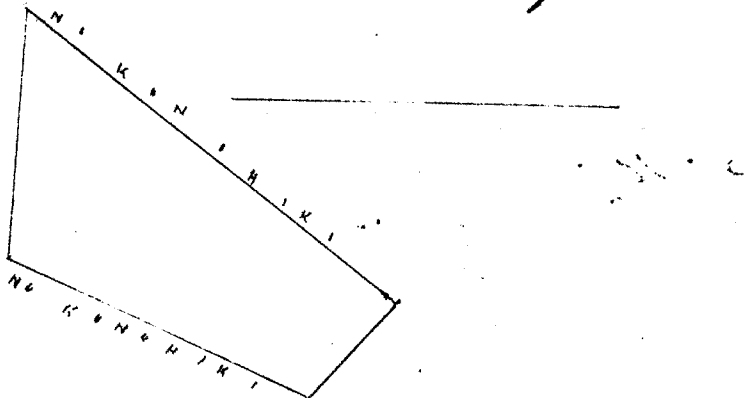

A. Bishop
 Mea ana,

Uku Pau Loa \$5.00
 W. H. Lee
 J. H. Smith
 G. M. Robertson

Honolulu July 5 1852 J. Kekaulaao
 Hele 8291 Koa-aku

Palolo Oahu

Apana 1 He palala o Kamanuena ili. Waiomas Palolo Oahu
 E hoomaka ana ke Piki Hikiina e hui ana Kom 84° Kom i 224 Kh ma ka palena o Kahaalena
 Mabaila aku AK 48° Kom i 120 Kh Mabaila aku AK 84° Hiki i 224 Kh ma ka palena o Konoiki
 Mabaila aku Kom 48 Hiki i 120 Kh ma ka Konoiki a hiki i ka hoomaka ana He 200 Kh huinaha

Apana 2 He mo aina i Koa-aku ili. Waiomas
 E hoomaka ana ke Piki Hikiina e hui ana AK 4° Kom i 020 Kh Mabaila aku Kom 48 Kom i 320 Kh ma ka
 awai Mabaila aku Kom 37° Kom i 150 Kh ma ka palena o Konoiki Mabaila aku Kom 17° Hiki i 120 Kh
 Mabaila aku AK 27° Hiki i 530 Kh ma ka Konoiki a hiki i ka hoomaka ana He 3 1/4 Kh huinaha

Apana 3, Elua hiki i loko. Koa-aku Waiomas
 E hoomaka ana ke Piki Hikiina e hui ana Kom 80° Hiki i 154 Kh ma ka palena o Konoiki Mabaila aku Kom
 14° Kom i 158 Kh Mabaila aku AK 80° Kom i 158 Kh ma ka Konoiki Mabaila aku AK 14° Hiki i
 158 Kh a hiki i ka hoomaka ana, He 2 5/10 Kh huinaha Pau loa 8 1/4 Kh huinaha

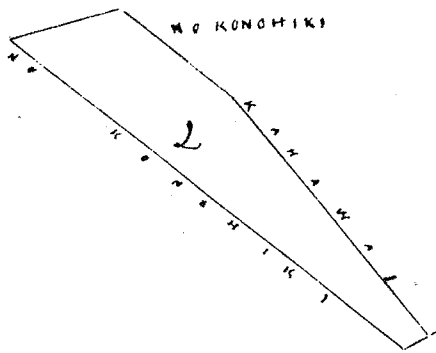
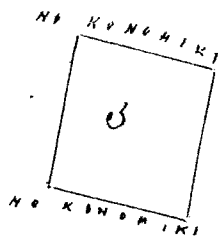

A. Bishop
 Mea ana,

Uku Pau Loa \$5.00
 W. H. Lee
 J. H. Smith
 G. M. Robertson

Honolulu July 5 1852 J. Kekaulaao

Hele 1900 Amala

Palolo Oahu

Moo Keonuliaku, ili o Wailupe, Palolo Oahu,
E hoomaka ma ke kiki Komohana, e huli ana, hem 49° hiki i 858 Kk, ma ka palena o Kalakauale, Malaila
aku, AK 44° hiki i 187 Kk, ma ka hawaii, Malaila aku, AK 52° hem i 460 Kk, ma ka palena o Pupuawa
Malaila aku, hem 48° hem i 150 Kk ma ka palena koke Malaila aku, AK 48° hiki i 150 Kk Malaila aku
AK 52° hem i 164 Kk ma ka palena o Pupuawa Malaila aku, hem 45° hem i 054 Kk Malaila aku AK 52°
hem i 120 Kk ma ka palena o Pupuawa Malaila aku, hem 43° hem i 111 Kk ma ka palena koke o Wailupe
a hiki i ka hoomaka ana i ka 2 1/2% Kk huinaha

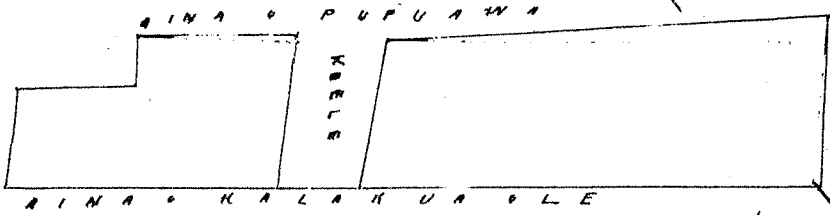

A Bishop Mea ana

Uku Pau Loa \$ 6.00

W. H. W.
J. H. Smith
G. M. Robertson

Honolulu Iulai 5 1852

J. Kikaulahao

Hele 1885 Panawa

Palolo Oahu

Ka moe aiaa Koroahi ili o Kapahulu Palolo Oahu
E hoomaka ma ke kiki Kama e huli ana AK 19° hem i 200 Kk ma ka palena o Mahana Malaila
aku, AK 18 1/2° hiki i 266 Kk ma ka palena o Konoehiki Malaila aku, AK 64° hem i 060 Kk Malaila
aku, AK 22° hiki i 100 Kk ma ka palena o Kalawa Malaila aku, AK 41 1/2° hem i 040 Kk
Malaila aku, AK 22° hiki i 460 Kk ma ka palena o Keams Malaila aku, hem 69° hiki i 122 Kk
ma ka palena o Kana Malaila aku, hem 25 1/2° hem i 080 Kk Malaila aku, hem 71° hiki i 200 Kk
ma ka palena o Konoehiki Malaila aku, hem 27° hem i 940 Kk ma ka palena o Keki a hiki i
ka hoomaka ana, 2 Eka 1 8/100 Kk huinaha

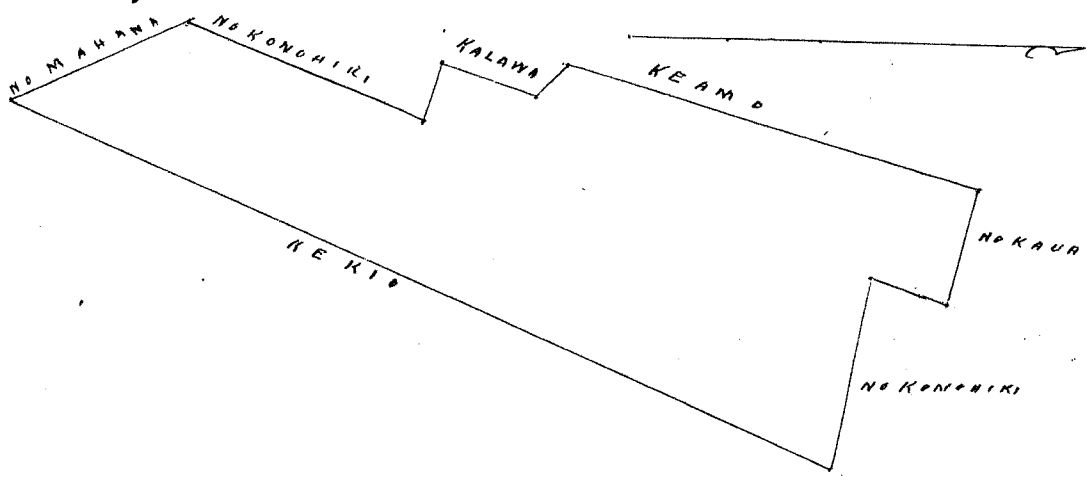

A Bishop Mea ana

Uku Pau Loa \$ 7.00

W. H. W.
G. M. Robertson
J. Kikaulahao
J. H. Smith

Honolulu Iulai 5 1852

Hele 1912 Malo

Palolo Oahu

Apana 1, Moe aiaa i loko o Humu Ili o Pukele Palolo Oahu,
E hoomaka ma ke kiki Kama, e huli ana AK 58° hem i 300 Kk ma ka palena o Konoehiki Malaila aku
AK 49° hiki i 380 Kk ma ka hawaii Malaila aku, hem 49 1/2° hiki i 096 Kk ma ka hawaii Malaila aku hem 12°
hem i 353 Kk ma ka palena o Konoehiki a hiki i ka hoomaka ana AK 7 2/100 Kk huinaha

Apana 2, Ke Mahuakali o Humu Pukele Palolo
E hoomaka ma ke kiki Akau, e huli ana, hem 25° hem i 200 Kk, ma ka palena aiaa o Malo Malaila aku, hem 52°
hiki i 200 Kk ma ka papohaku Malaila aku, AK 25° hiki i 200 Kk Malaila aku, AK 62° hem i 200 Kk a
hiki ma kahi i hoomaka ana AK 4,00 Kk huinaha Kama 7 2/100 Kk huinaha

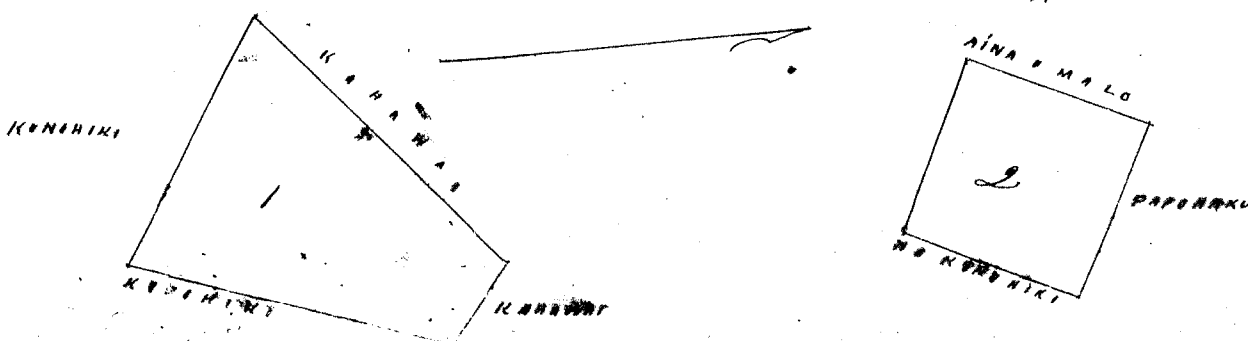

A Bishop Mea ana

Uku Pau Loa # 5.00
W. H. K.

J. H. Smith
G. M. Robertson

Honolulu Iulai 5 1852 J. Kaulahao

Heleu 1891 Golo

Palolo Oahu

Aprana 1 Ke Kahuahala owa Male ili o Kekai Palolo Waiitihi Oahu,
E hoomaka ma ke kahi Kauhaha i huli ana hem 65° Niki i 200 Kk ma ka palena o Papuaa Malaila
aku, AK 25° Niki i 125 Kk ma ka palena Kula. Konoiki Malaila aku, AK 65° Hem i 200 Kk ma
laila aku hem 25° Hem i 125 Kk ma ka palena atarui a hiki i ka hoomaka ana He 25/100
Kk huinaha

Aprana 2. Moa Moiki iloko o Kekai Palolo
E hoomaka ma ke kahi Kihina i huli ana hem 36° Hem i 240 Kk ma ka palena o Konoiki Ma
laila aku, hem 71° Hem i 030 Kk Malaila aku AK 38° Hem i 111 Kk ma ka palena o Kauhaha
Malaila aku, hem 54° Hem i 130 Kk Malaila aku, AK 29° Hem i 080 Kk Malaila aku
AK 39° Niki i 140 Kk ma ka palena o Konoiki Malaila aku, AK 51° Niki i 190 Kk ma ka
palena o Konoiki Malaila aku, hem 58° Niki i 180 Kk ma ka palena Hele a hiki i ka
hoomaka ana He 8 6/100 Kk huinaha Pau loa 1 Eka 1 1/100 Kk huinaha

A Bishop Mea ana

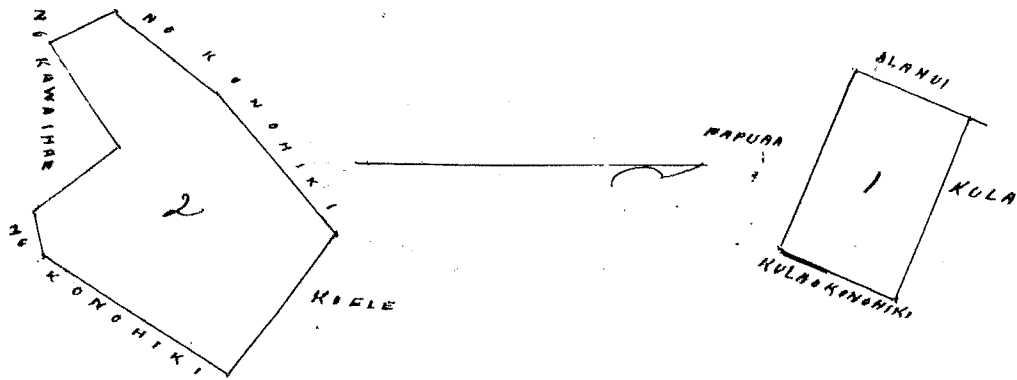

Uku Pau Loa # 6.00
W. H. K.

J. H. Smith
G. M. Robertson

Honolulu Iulai 5 1852 J. Kaulahao

Heleu 10169 Moakoe

Palolo Oahu

Ke owa Kalo Kopenui ili o Pukele Palolo Oahu
E hoomaka ma ke kahi Kama i huli ana AK 62 1/2° Hem i 174 Kk ma ka palena o Kauhaha
Malaila aku AK 27° Niki i 400 Kk ma ka palena o Konoiki Malaila aku, AK 52° Hem i
180 Kk Malaila aku, AK 12° Niki i 545 Kk ma ka palena o Konoiki Malaila aku,
hem 84° Niki i 246 Kk Malaila aku, hem 13 1/2° Hem i 1140 Kk ma Kauhaha a hiki i ka
hoomaka ana He 2 Eka 0 68/100 Kk huinaha

A Bishop
Mea ana

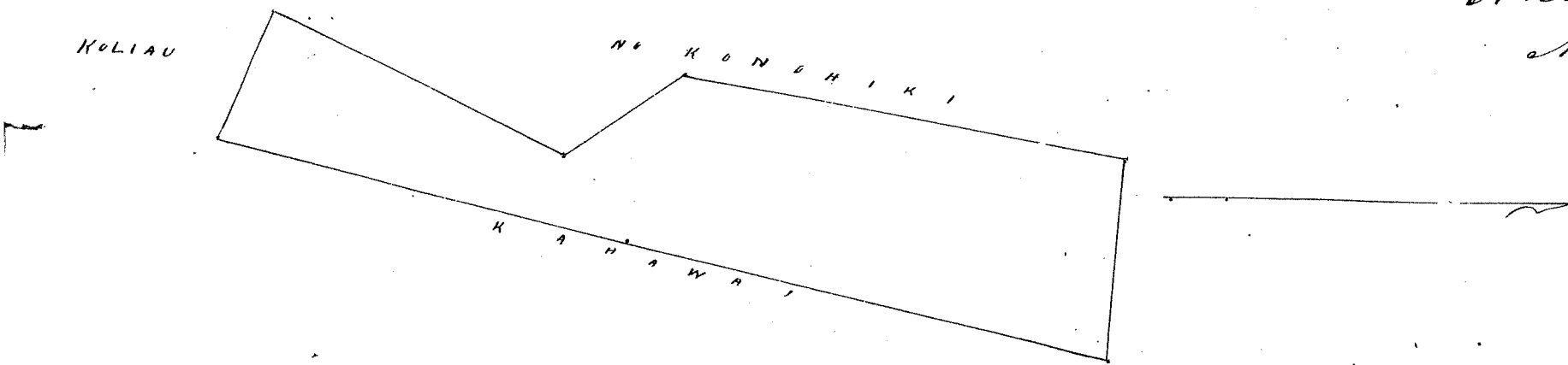

Uku Pau Loa # 6.

W. H. K.
G. M. Robertson
J. H. Smith

J. Kaulahao

Honolulu July 5 1852

Ana 1/2 in - 1 Kaul

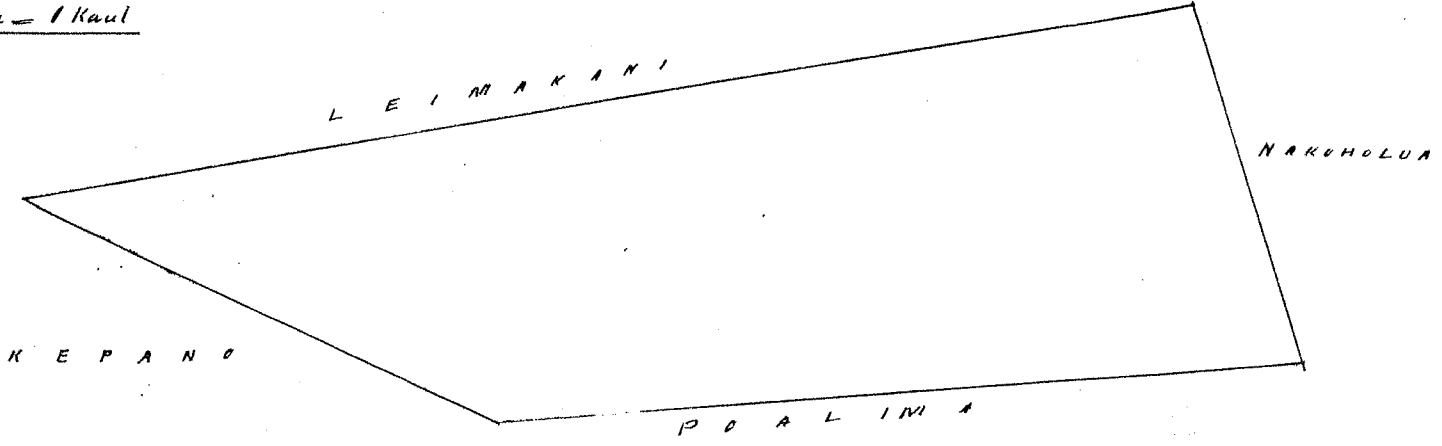

R. W. Meyer, Surveyor

Uku Pau Loa \$ 5.00

W. L. Lee

J. H. Smith, G. M. Robertson, J. Kaulahao

Honolulu Iulai 5 1852

Hoelu 4115 Kahuau 1

Manowai Molokai

4115 Kahuau 1 Manowai ili Apahiki Molokai

Apana 1 Chomaka ma Ke Pihii Kom Ake via loi a e holo ana Ake 12 1/2 Hi 81 Kaul ma Ke Kuaana alaila He 12 1/2 Hi 94 Kaul ma Ke Konohiki alaila He 70 Hi 70 Kk ma Ke Kapehane Ake 7 Hi 87 Kk ma Ke Manukani a hiki i Kahi i hoomaka maia Apana 100 anana

Apana 2 Chomaka ma Ke Pihii Hi He. maanei via aina a e holo ana Ake 52 Hi 80 Kaul ma Ke Keki alaila He 40 Hi 25 Kk ma Ke Kalamaika alaila He 3 1/2 Hi 20 50 Kaul ma Ke pali alaila Ake 49 Hi 260 Kaul ma Ke Kahiapaiole a hiki i Kahi i hoomaka maia Apana 4 Eka 1115 anana

R. W. Meyer Surveyor

Mai 15 1852

100 A, 4E 1115, 734, 435 P6, 1949, 1226, 50-739

Ana 1/4 in - 1 Kaul

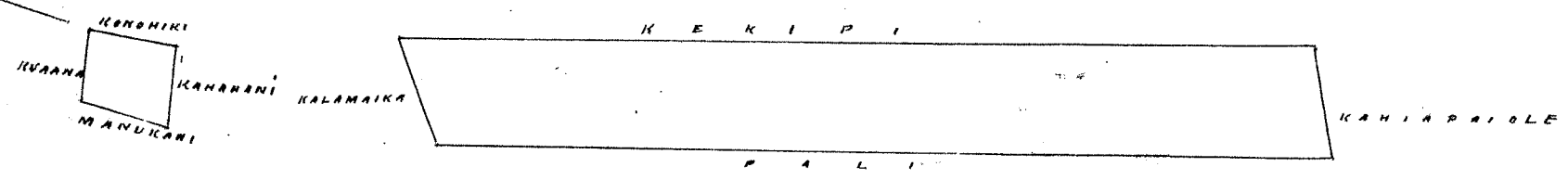

R. W. Meyer, Surveyor

Uku Pau Loa \$ 6.00

W. L. Lee

G. M. Robertson, J. H. Smith

Honolulu Iulai 5 1852

Hoelu 3662 Mahuka +

Waialua Molokai

Mahuka Waialua Molokai ili, Pahala

Apana 1 Chomaka ma Ke Pihii Komohana He maanei. Keia aina a e holo ana Ake 46 1/4 Kom 1 Kk 69 ptk. ma Ke Kahuwai alaila Ake 44 3/4 Hi 8 Kk 95 ptk. ma Ke Lili alaila He 36 1/2 Hi 2 Kk ma Ke pali alaila He 45 3/4 Kom 8 Kk 60 ptk. ma Ke Kanakaole a hiki i Kahi i hoomaka maia Apana 1 Eka 505 Anana

Apana 2 Chomaka ma Ke Pihii Hi He malalo via aina a holo ana Ake 50 Kom 8 Kk 36 ptk ma Ke Kahuwai alaila Ake 40 Hi 2 Kk 00 ptk ma Ke Konohiki alaila He 58 Hi 7 Kk 95 ptk ma Ke pali he 38 3/4 Kom 3 Kk 00 ptk ma Ke Konohiki a hiki i Kahi i hoomaka maia Apana 1 1/4 Eka

Apana 1/4 Eka Apana 1/4 Eka Ke Konohiki ma alohe. Keia Apana aina

Maraki 24 1852

R. W. Meyer Surveyor

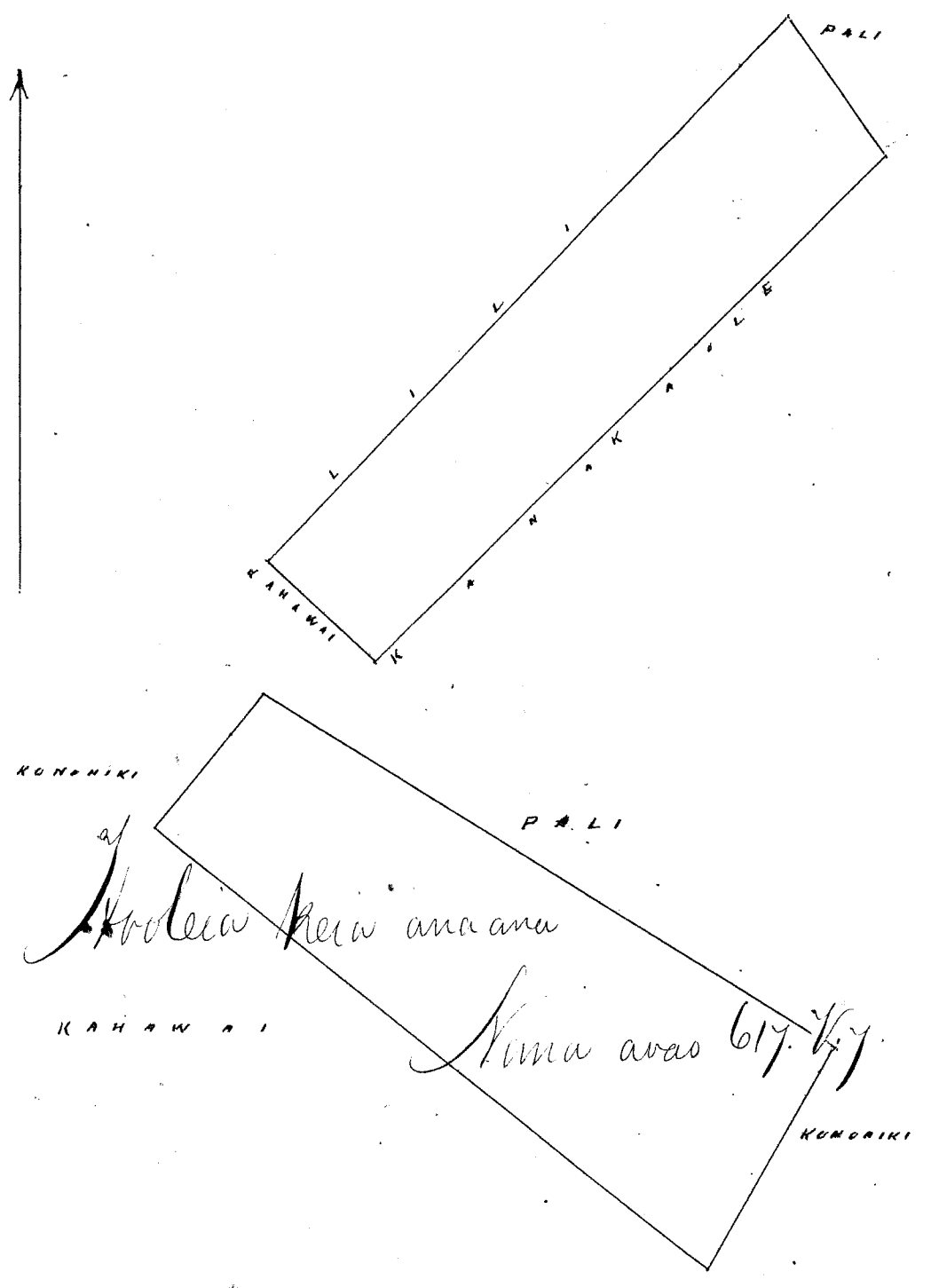

Ana 1/2 in = 1 Kaul

R. W. Meyer
Surveyor

Uku Pau Loa \$ 6.00

W. L. Lee
 J. H. Smith
 G. M. Robertson
 J. Kihaulaha

Honolulu Iulai 17 1852

Heleu 4187 Kahookano

Ohia Molokai

Heleu 4187 Kahookano Ohia Molokai
 E hoomaka ma ke Niihi ki Akia aia a e holo ana He 71 1/2 He 262 Kaul ma ke Melakua
 alaila He 6 He 299 Kaul ma ke Keili alaila Akau 68 He 123 Kaul ma ke Konohiki alaila
 Ak 6 1/2 He 39 Kaul ma ke Kamakulua alaila Ak 58 He 107 Kaul ma ke Kamakulua alaila
 He 22 He 80 Kaul ma ke Kamakulua Ak 69 1/2 He 94 Kaul ma ke Kamakulua alaila
 Ak 14 He 293 Kaul ma ke Manowai - a hiki i Kahi i hoomaka ia maia Apana 947
 Anama

Mai 15 1852

R. W. Meyer
Surveyor

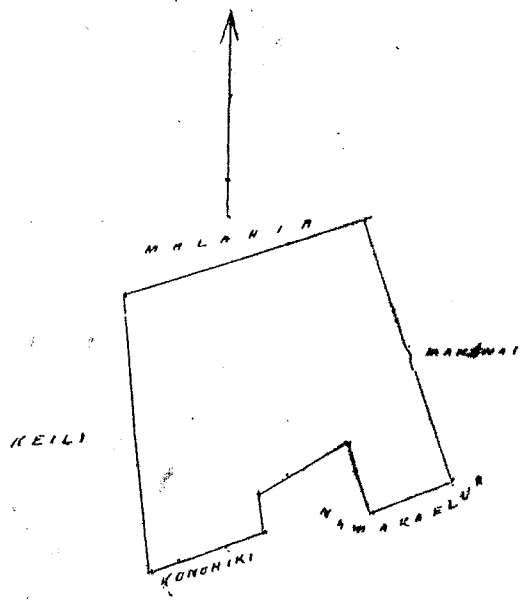

Ana 1/2 in = 1 Kaul

R. W. Meyer
Surveyor

Uku Pau Loa \$ 4.00

W. L. Lee
 G. M. Robertson
 J. H. Smith
 J. Kihaulaha

Honolulu Iulai 17 1852

Heleu 4821 B. Paipaike

Ohia Molokai

Paipaike Ohia ili. Kalacke Molokai

Apana 1. E hoomaka ma ke kahi ki Ah via aina a e holo ana $AK 65 \frac{1}{2}$ Ki 342 Kaul alaila $AK 26$ Ki 237 Kaul ma ke Kauliki alaila $AK 68$ Ki 283 ma ke alanui alaila $AK 18 \frac{1}{2}$ Ki 104 Ah ma ke Konohiki $AK 33$ Ki 163 Kaul ma ke Konohiki alaila a hiki i kahi i hoomaka ia maia Apana 110 Apana

Apana 2. E hoomaka ma ke kahi ki Ah via aina a e holo ana $AK 66$ Ki 115 Ah ma ke Kauliki alaila $AK 19$ Ki 878 Kaul. ma ke Konohiki alaila $AK 81 \frac{1}{2}$ Ki 240 Ah ma ke Konohiki alaila $AK 26 \frac{1}{2}$ Ki 940 Ah ma Kauliki a hiki i kahi i hoomaka ia maia Apana 1 Eka 683 anana,

Apana 3. E hoomaka ma ke kahi ki Ah via aina a e holo ana $AK 63 \frac{1}{2}$ Ki 8 Kaul ma ke Konohiki alaila $AK 83 \frac{1}{4}$ Ki 200 Kaul. ma ke Konohiki alaila $AK 15$ Ki 880 Ah ma ke pali alaila $AK 85 \frac{1}{2}$ Ki 350 Ah ma ke Konohiki a hiki i kahi i hoomaka ia maia Apana 2 Eka 254 Apana.

Mei 15 1852

R W Meyer
Surveyor

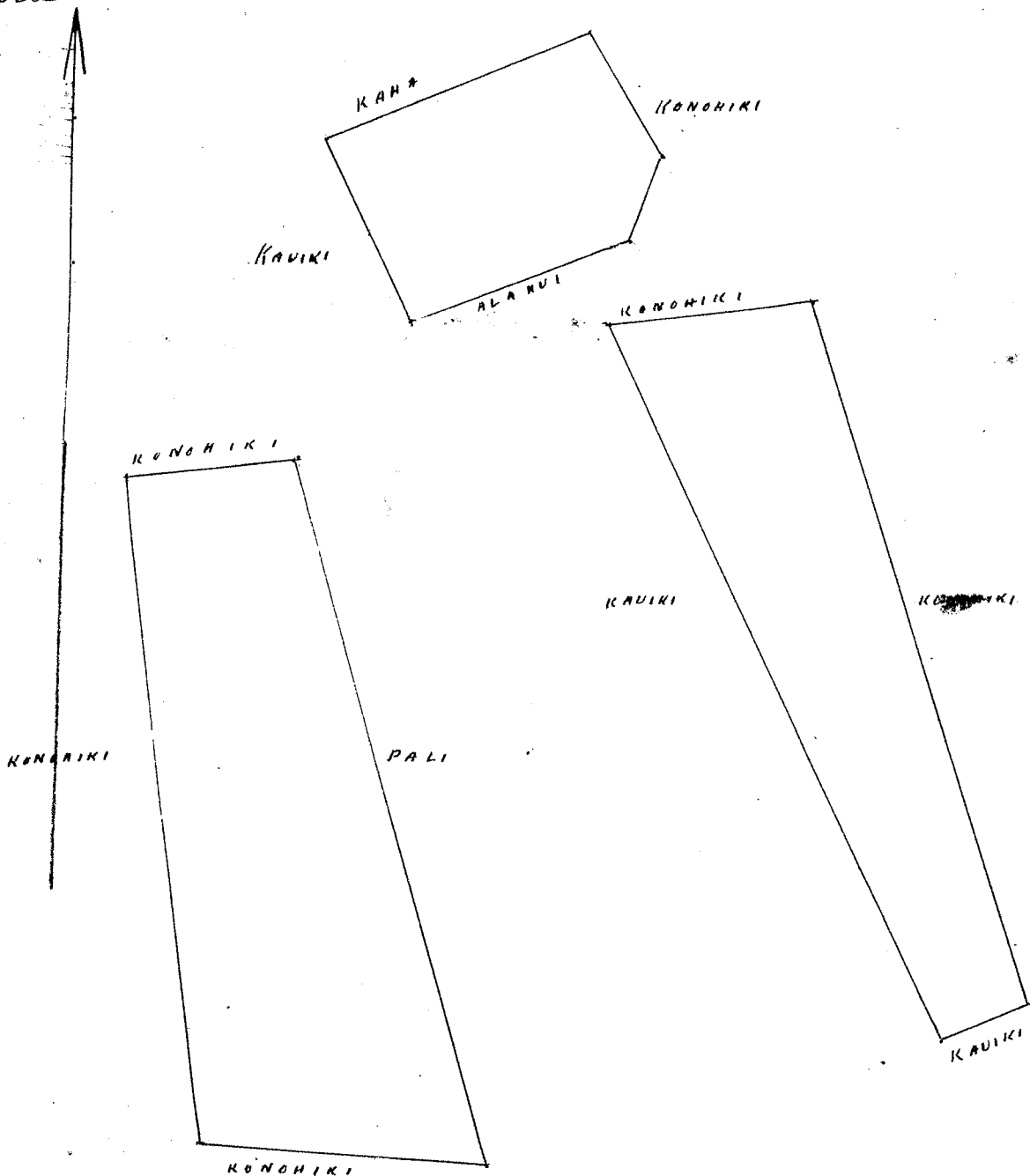

1010
 18 683
 2 254
 . 7947
 1210
 46 737

One 1/2 in = 1 Kaula

Wm Pau Ira \$ 6.00

W. L. Lee
J. H. Smith
G. M. Robertson
J. Kekaulaha

Honolulu Pulai 17 1852

Heleu 5187 Kaluan 3

Ohia Molokai

Kaluan 3. Ohia ili. ^{Kaula, Marowai} Molokai

Apana 1. Ioi, E hoomaka ana ma ke kahi ki Ah via Ioi a e holo ana $AK 77$ Ki 083 $\frac{1}{2}$ Ah ma ke Konohiki alaila $AK 55$ Ki 029 Ah ma ke Katiwe alaila $AK 28 \frac{1}{2}$ Ki 065 Ah ma ke Katiwe alaila $AK 69 \frac{1}{2}$ Ki 103 Ah ma ke Katiwe alaila $AK 23 \frac{1}{2}$ Ki 107 ma ke Hapuku a hiki i kahi i hoomaka ia maia Apana 109 anana

Mei 15 1852

R W Meyer
Surveyor

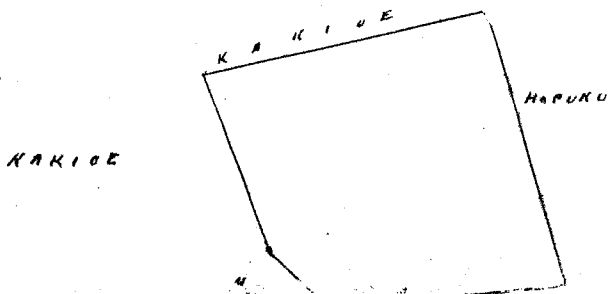

One 1/2 in = 1 Kaula

W. L. Lee
G. M. Robertson
J. H. Smith

Honolulu Iulai 17 1852

J. Kaulahao

Heleu 4899 Kalamaiika

Manawai Molokai

Kalamaiika Manawai Ili Kihikua Molokai
Chomaka ma ke Kihikua oia aina AK 33° Ho 10 Kaul ma ka pali alaila AK 57° Ho 5 Kaul
ma ke Keaki alaila He 33° Ho 10 Kaul, ma ka pali alaila He 57° Ho 5 Kaul ma ka pali
a hiki i Kahi i hoomaka ia ma ia Apana 5 Eka

R. W. Meyer
Surveyor

May 15 1852

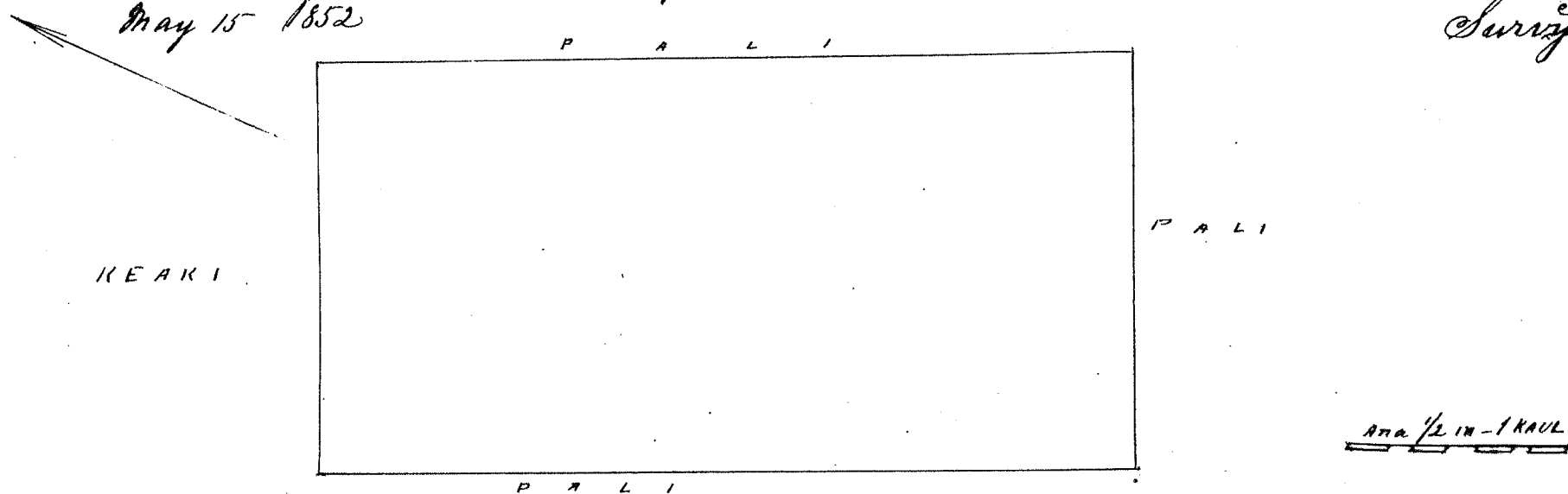

Uku Pau Loa # 6.00

W. L. Lee
G. M. Robertson
J. H. Smith

Honolulu Iulai 17 1852

J. Kaulahao

Heleu 3751 Waiaholo

See V7 P 642 Re after award in place of Manawai Molokai

Waiaholo Manawai Ili o Kaulahao Molokai
Ap 1 Chomaka ma ke Kihikua Kom Akau oia Ili a e holo ana He 15° Ho 0,48 ma ke Kapuku alaila AK
84 1/2 Ho 0,75 Kaul, ma ke Konoehiki alaila He 9° Ho 0,58 Kaul ma ke Konoehiki alaila AK 84° Ho 0,58
ma ke Kahuau alaila AK 60 1/2 Ho 0,49 Kaul ma ke Kahuau alaila AK 21 1/2 Ho 0,01 Kaulahao
ma ke Kahuahalahala alaila He 69° Ho 0,22 Kaul ma ke Kahuahalahala alaila He 79° Ho 0,70
Kaul, ma ke Kahuahalahala He 75 Ho 0,00 Kaul ma ke Kahuahalahala a hiki i Kahi i hoomaka
ia ma ia Apana, 224 Apana.

R. W. Meyer
Surveyor

Apana 2 Chomaka ma ke Kihikua Komohana Akau, maani oia aina a e holo ana He 82 1/2°
Ho 3,34 Kaul ma ke Kahuahalahala alaila, He 36° Ho 14,90 Kaul ma ke Kahuahalahala alaila AK 53 1/4 Ho
5,00 Kaul, ma ke Kahuahalahala alaila AK 45 Ho 13,34 Kaul ma ka pali a hiki i Kahi i hoomaka ia
Maia Apana, 5 1/2 Eka,
Mei 15, 1852

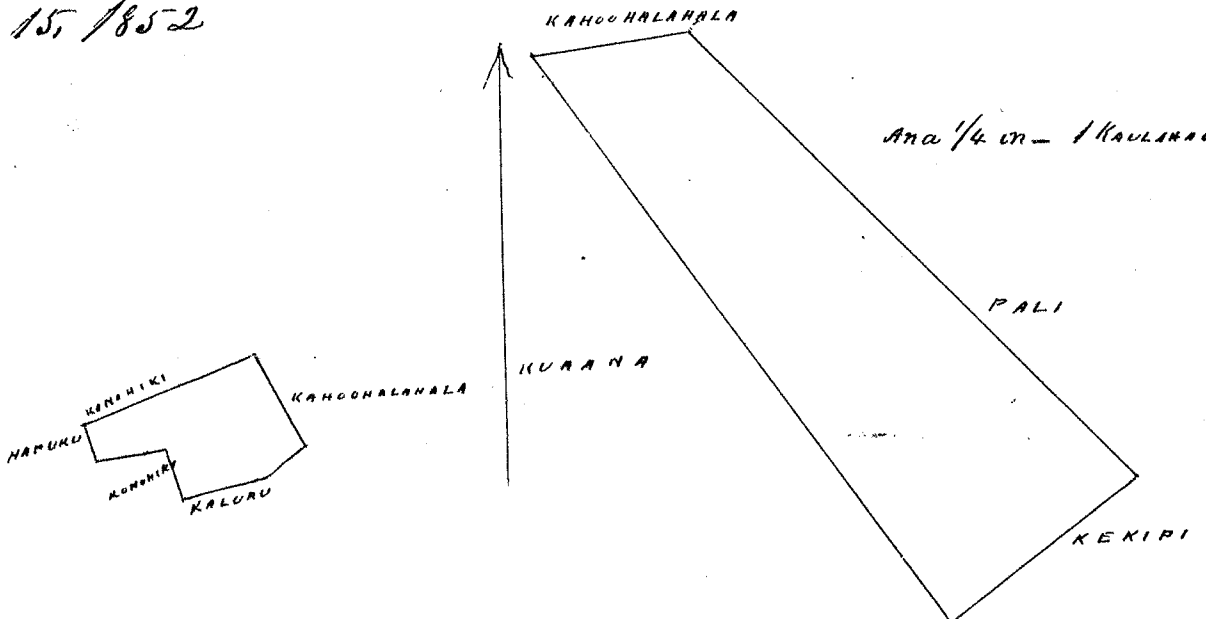

ANA 1/2 in - 1 KAUL

Uku Pau Loa # 6.00

W. L. Lee
G. M. Robertson

Honolulu Iulai 17 1852

J. H. Smith
J. Kaulahao

Heleu 3667 Manukani (6967)

Manawai Molokai

Manukani Manawai ili o Kaluaolepau Molokai

Apana 1 E hoomaka ma Kora Ke Kihikihi Kihina Apana ia aima a i holo ana Ke 7 Ni 87 ft ma Kaluan 1. alaila Ke 85 Ni 92, paau ma Ke Kahakane alaila Ke 31 Ni 16 ft, ma Ke Kahakane alaila Ke 4 Ni 10 ft, ma Ke Kahakane alaila Ke 7 1/4 Ni 1 Kaul, ma Ke Kuaana a hiki i Kahi i hoomaka ia, Maia Apana 10 Apana

Apana 2 E hoomaka ma Ke Kihikihi Kihina Apana, malalo ia aima a i holo ana Ke 30 1/4 Ni 14, 00 Kaul ma Ke Kahakane alaila Ke 57 Ni 34 0 Kaul, ma Ke Waiahole Ke 28 Ni 15, 00 Kaul ma Ke Limakani alaila Ke 71 1/4 Ni 42 1 Kaul ma Ke Kaauhakani a hiki i Kahi i hoomaka ia ma ia Apana 5 1/10 Eka
Mei 15 1852
R W Meyer
Surveyor

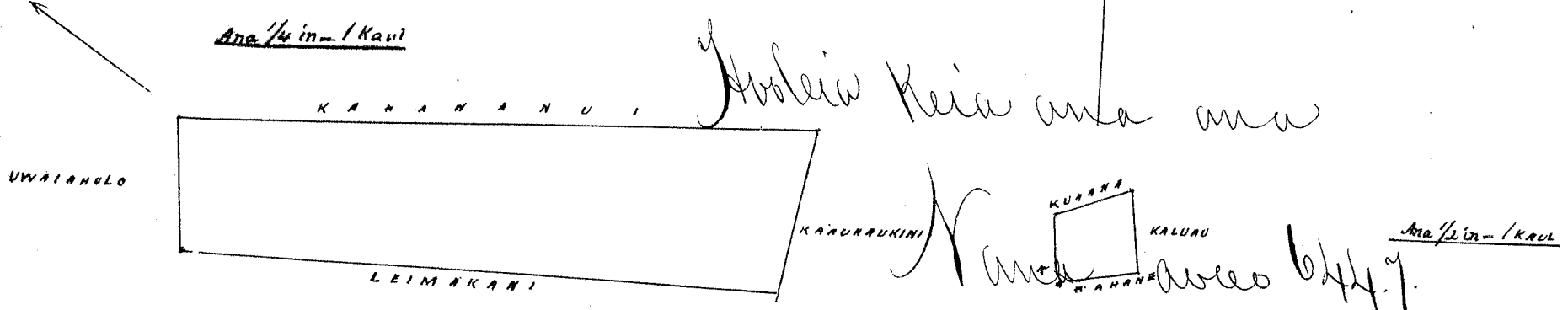

Wm Pau Loa \$ 6.00 W. L. Lee

G. M. Robertson
J. H. Smith

Honolulu Julai 17 1852

J. Kapaunahao

Heleu 4985 Heaki

Manawai Molokai

Heaki Manawai Ili Puhalaawai Molokai

Apana 1 E hoomaka ma Ke Kihikihi Kihina Apana ia aima a i holo ana Ke 84 1/2 Ni 416 Kaul ma Ke Kuaana alaila Ke 86 1/2 Ni 0.68 Kaul ma Ke Konoiki Ke 43 1/4 Ni 126 Kaul ma Ke Konoiki alaila Ke 15 1/2 Ni 170 Kaul ma Ke Konoiki alaila Ke 20 Ni 1,55 Kaul, ma Ke Laakala alaila Ke 56 1/2 Ni 1,02 Kaul ma Ke Konoiki alaila Ke 31 1/4 Ni 1,21 Kaul ma Ke Kepano alaila Ke 39 1/2 Ni 21 Kaul ma Ke Kepano alaila Ke 36 1/4 Ni 80 Kaul, ma Ke Kepano alaila Ke 31 Ni 55 Kaul ma Ke Kepano a hiki i Kahi i hoomaka ia ma ia apana 792 Apana

Apana 2 E hoomaka ma Ke Kihikihi Kihina Apana ia aima a i holo ana Ke 33 Ni 10,00 Kaul ma Ke Pali alaila Ke 57 Ni 5,00 Kaul ma Ke Pali alaila Ke 33 Ni 10,00 Kaul ma Ke Pali alaila Ke 57 Ni 5,00 Kaul ma Ke Pali, a hiki ma Kahi i hoomaka ia Maia Apana 5 Eka
Mei 15 1852
R W Meyer
Surveyor

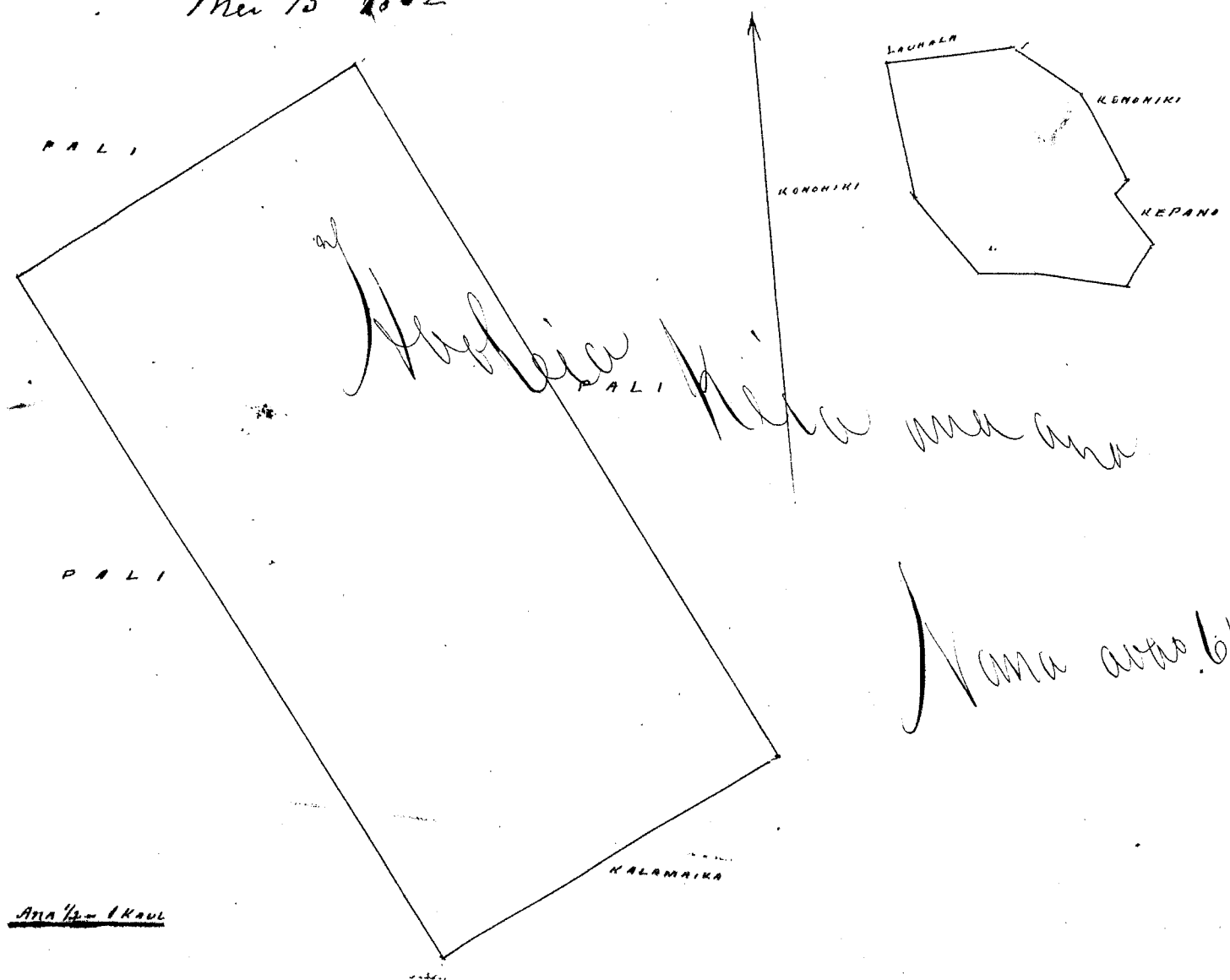

Kana arua 641.7

Honolulu July 17 1852

J. H. Smith
G. M. Robertson
J. Kaulahao

Heleu 4095 Kahookalahala

Manowai Molokai

Kahookalahala Manowai ili o Hikutui Nona Molokai

Apana 1 E hoomaka ma ke kiki ke ke via Loo a e holo ana, Ak 15° Ke 0.85 Kaulahao ma ke Kuaana alaila Ke 88 1/2° Ke 400 Kaul ma ke Kaiwa alaila Ke 85° Ke 100 Kaul, ma ke Konoiki Ke alaila Ak 7 1/4° Ke 90 Ke ma ke Kuaana, a hiki i kahi i hoomaka ia, maia Apana 16 anana

116A
38 908
409
1433
1200
223

Apana 2 E hoomaka ma ke kiki Kikina Nona maanei via aina a e holo ana, Ak 28° Ke 1184 Kaul, ma ka pali alaila Ak 60 1/2° Ke 850 Kaul ma ke Konoiki alaila Ke 28 1/2° Ke 17,92 Kaul ma Kahawai alaila Ke 60 1/2° Ke 2,00 Kaul, ma ke Waiakolo a hiki ma kahi i hoomaka ia maia Apana 3 3/4 Eka

Mei 15 1853

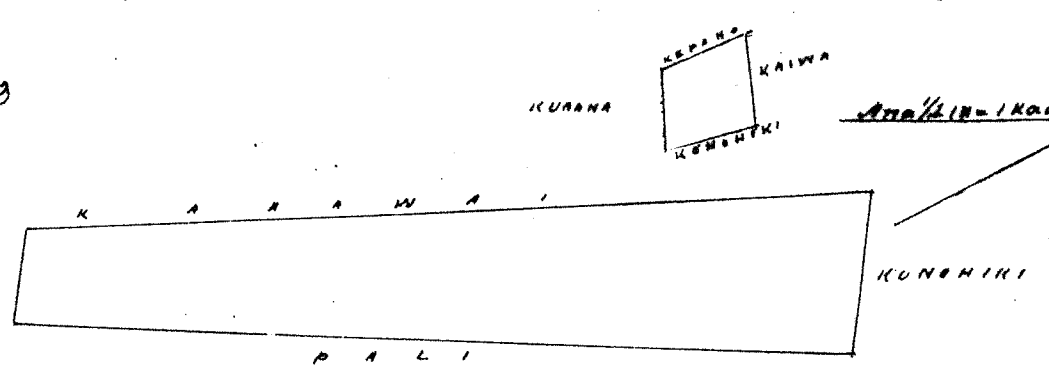

R. W. Meyer
Surveyor

Wm Pau Loa \$6.00 W. L. Lee

G. M. Robertson
J. H. Smith
J. Kaulahao

Honolulu July 17 1852

Heleu 9102 Kauhaukini

Malapue Molokai

Kauhaukini Malapue ili o Aihii Molokai

Apana 2 Kula, E hoomaka ma ke kiki Kikina Nona via aina a e holo ana, Ke 63 1/2° Ke 446 Kaul ma ke Konoiki alaila Ak 46 1/2° Ke 407 Kaul, ma ke Konoiki alaila Ak 65° Ke 586 Kaul ma ke Leimakani alaila Ke 15 1/2° Ke 3,96 Kaul ma ke Kahanani a hiki i ka hoomaka ana, Maia Apana 1 Eka 1191 anana

Mei 15 1852

245
1,436
1,210
226
LEIMAKANI

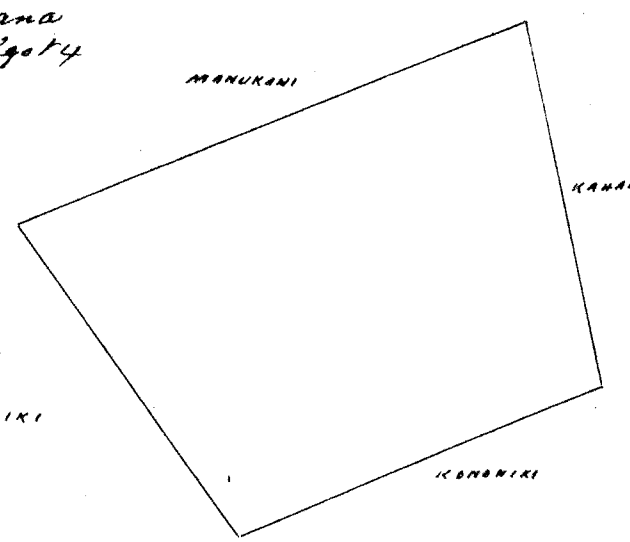

R. W. Meyer
Surveyor

Wm Pau Loa \$5.00 W. L. Lee

G. M. Robertson
J. H. Smith

Honolulu July 17 1852

Heleu 4683 Leimakani

Manowai Molokai

Leimakani Manowai ili o Kukaiole Molokai

1 E hoomaka ma ke kiki Kikina via aina a e holo ana Ke 77° Ke 191 Kaul ma ke Kaiwa alaila Ak 42° Ke 55 Kaul, ma ke Kaiwa alaila Ak 75° Ke 87 Kaul, ma ke Kiki alaila Ak 10° Ke 100 Kaul, ma ke Kiki Ke 77 1/4° Ke 1,33 Kaul ma ke Kahaia Kuaana alaila Ke 30 Ke 34 Kaul ma ke Kaiwa a hiki i kahi i hoomaka ia maia Apana 136 anana

Apana 2 E hoomaka ma ke kiki Nona via aina a e holo ana, Ak 71 1/2° Ke 444 Kaul ma ke Konoiki alaila Ak 28° Ke 14,10 Kaul ma ke Maunakani alaila Ke 55 1/2° Ke 2,800 Kaul

ma ke Kahala alaila Ke 29 3/4 Ki 22 25 Kaul. ma ke Kulu a hiki i kahi i hoomaka ia maia
Apana 6 Eka 108 Anana
Mai 15 1852

R. H. Meyer,
Surveyor

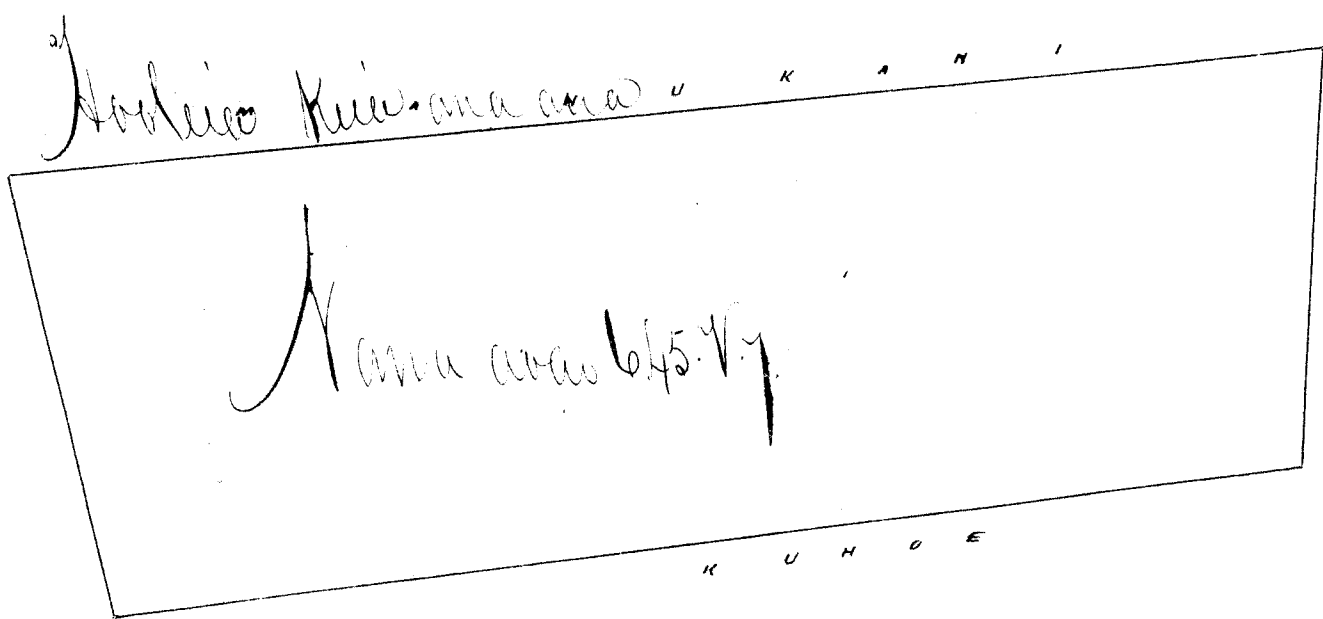
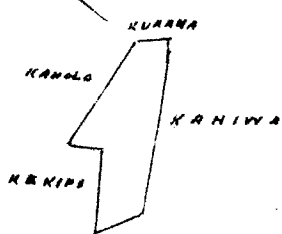

Whu Pau Ika \$ 6,00 W. L. Lee

J. H. Smith
G. M. Robertson
J. Kekaulahao

Honolulu Iulai 17 1852

No 4682 Luia

Ohia Molokai

Luia Ohia ili. Papohaku Molokai

hoomaka ma ke kahi ium via Lii a e holo ana Ah 31' Ke 57 pautu ma ke pa alaila Ah 65 1/2 Ki 68 pautu
ma ke Konoiki alaila Ke 10 1/2 Ki 58 pautu ma ke Kamaelua alaila Ke 65' Ke 45 pautu ma ke
Kikau a hiki i kahi i hoomaka ia Maia Apana 36 Anana,

Apana 2 hoomaka ma ke kahi i kama maanei via aina a e holo ana Ah 25 1/2 Ke 26
Kaul. 45 pautu ma ke Kamaelua alaila Ke 64 1/4 Ke 2 Kaul ma ke Kikau alaila Ke 26' Ki 26 Kaul 46 ptk
ma ke pali, alaila Ah 64 3/4 Ki 1 Kaul. 50 pautu ma ke Konoiki a hiki i kahi i hoomaka ia ma
ia Apana 4 Eka 760 Anana,

Mai 15 1852

R. H. Meyer,
Surveyor

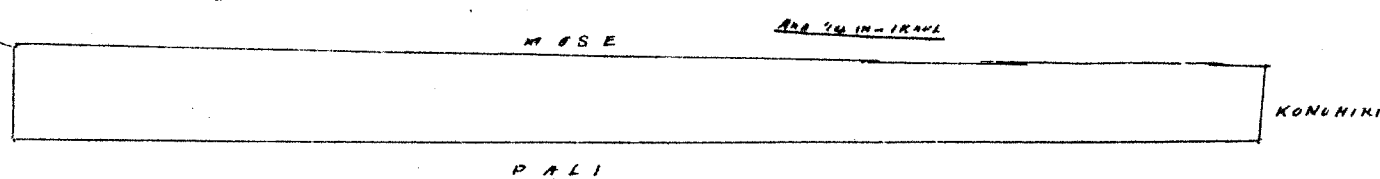

Whu Pau Ika \$ 6 W. L. Lee

J. H. Smith
G. M. Robertson
J. Kekaulahao

Honolulu Iulai 17 1852

No 4097 Kuaana

Manowai Molokai

Kuaana Manowai ili. Kouluakapahu Molokai

Apana 1 hoomaka ma ke kahi Konoikana Kama via Lii a e holo ana Ah 81 1/2 Ki 1 Kaul. 25 pautu
ma ke Konoiki alaila Ah 31 1/2 Ki 47 pautu ma ke Konoiki alaila Ah 80' Ke 1 Kaul. 64 pautu
ma ke Konoiki Ke 12 1/2 Ki 19 pautu ma ke Kamaelua alaila Ke 62 1/2 Ki 76 pautu a hiki i kahi
i hoomaka ia Maia Apana 124 anana

Apana 2 hoomaka ma ke kahi i ke via aina a e holo ana Ke 73 Ke 53 pautu
ma ke Kahakane alaila Ah 65 1/2 Ke 27 pautu ma ke Kamaelua alaila Ah 69' Ki 50 pautu
ma ke Kamaelua 2 alaila Ke 18 1/2 Ki 24 pautu ma ke Kamaelua a hiki i kahi i
hoomaka ia Maia Apana 48 anana,

Apana 3 hoomaka ma ke kahi i kama maanei via aina a e holo
ana Ah 35' Ke 15 Kaul. ma ke Kamaelua alaila Ah 82 1/2 Ke 1 Kaul. 20 ptk ma ke
Kamaelua alaila Ke 85 1/4 Ke 4 Ah 05 ptk ma ke Kamaelua alaila Ke 46'
Ki 16 Ki 90 ptk. ma ke pali, alaila Ah 57' Ki 1 Ki 47 ptk ma ke Kamaelua a
hiki i kahi i hoomaka ia Maia Apana 4 Eka 931 Anana

124
4,931
4,7055

Ma ke kahi i ke Apana
i ke Konoiki J. H.

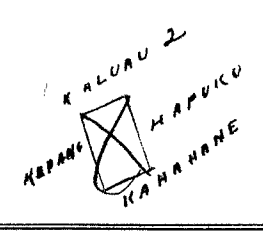
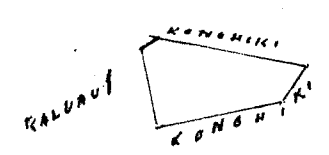
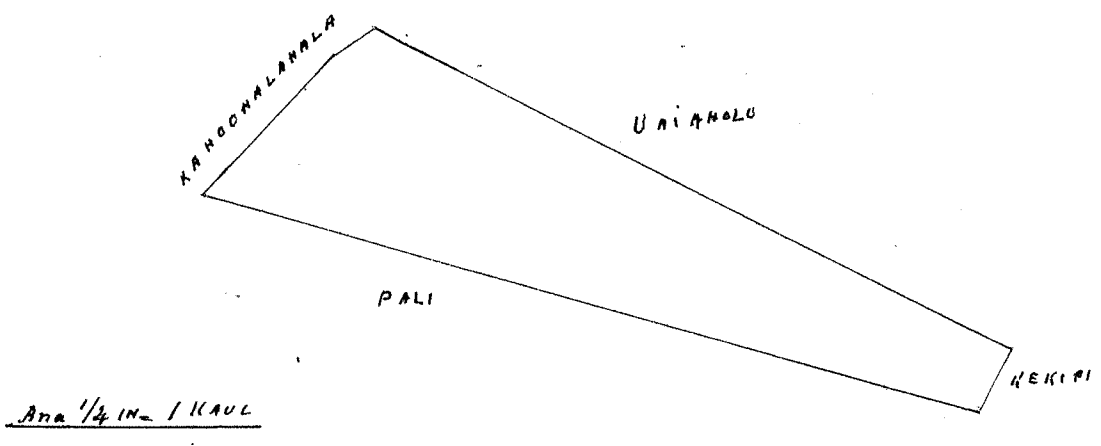

Ana 1/2 in = 1 Kaul

Uku Pau Loa \$6.00

W. L. Lee

J. M. Smith
G. M. Robertson

J. Kekaulahe

Honolulu Iulai 17 1852

Hoenu 5135 Hekepi

Manowai Molokai

Hekepi Manowai ili o Hekepi i Molokai
 Apana 1 E hoomaka ma ke kahi Komohana Akau via Loi a e holo ana He 15° Ki 657 Kaul. ma ka Kaha-
 lo alaila Ak 75° Ki 487 Kaul, ma ke Limakani alaila Ak 10° Ki 638 Kaul ma ke Limakani alaila He 85 1/2°
 Ki 466 Kaul ma ke Kahohohona a hiki i kahi i hoomaka ia maia Apana 42 1/2 anana

Apana 2 E hoomaka ana ma ke kahi Kikina Kema maanei via aina a e holo ana Ak 21° Ki 29, 86 Kaul, ma ka pali alaila He 56° Ki 256 Kaul, ma ke Kanaana alaila He 54° Ki 16, 57 Kaul ma ke
 Kaha, alaila He 28 3/4° Ki 16, 00 Kaul, ma ke Kaha alaila Ak 62° Ki 5, 00 Kaul ma ke kahi a paila
 a hiki i kahi i hoomaka ia maia Apana 5 Eka 428 Anana

Mei 15 1852

R. W. Meyer
Surveyor

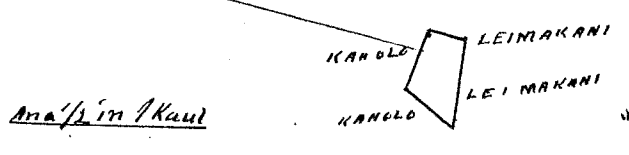

Ana 1/2 in = 1 Kaul

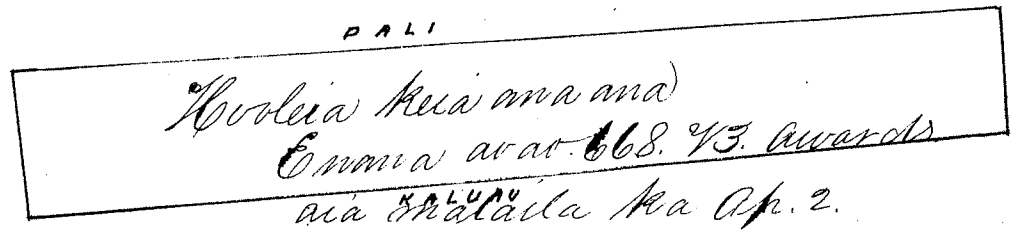

KANAPAILOE

Ana 1/2 in = 1 Kaul

Uku Pau Loa \$2.00

W. L. Lee

J. M. Smith
G. M. Robertson

J. Kekaulahe

Honolulu Iulai 17 1852

Hoenu 8931 Heke

Kamalo Molokai

Heke Kamalo ili o Malua Molokai

Apana 1 E hoomaka ana ma ke kahi Kema via Loi a e holo ana Ak 80 1/2° Ki Kaul 97 paku
 ma ke Komohiki alaila Ak 15 1/2° Kom 1 Kaul, 32 paku, ma ke Kapuaili alaila Ak 87° Kom 26 paku
 ma ke Loi Anupuni alaila Ak 19 1/2° Kom 4 Kaul 48 paku ma ke Loi Anupuni He 55° Kom 1 Kaul 23 paku
 ma ke pa Holohona alaila He 12 3/4° Ki 5 Kaul 29 paku, ma ke Komohiki a hiki ma kahi i hooma-
 ka ia maia Apana 104 1/10 Anana

1041.90
25
\$ 554

Apana 2 Pahale E hoomaka ana ma ke kahi Kema via aina a e holo ana Kom 65 1/2° Kom 1 Kaul
 1620.909 paku, ma ke Loi Kalo, alaila Ak 28 1/4° Kom 2 Kaul, 3 paku, ma ke Kawaia, Ak 67 1/2° Ki 11th 09 paku
 2 E 470.90 ma ke Kilaauka alaila He 28° Ki 2 Kaul, 30 paku, ma ke Loi a hiki i kahi i hoomaka ia maia Apana
 ana 1/2 Eka

Apana 3 Aina Kula E hoomaka ana ma ke kahi Komohana Kema via Loi a e holo ana
 Akau 68 1/2° Ki 2 Kaul, 22 1/2 paku ma ke alanui alaila Akau 11° Kom 5 Kaul 48 paku, ma ke Kapu-
 aile alaila Kema, 84 1/2° Kom 2 Kaul 89 paku ma ke Komohiki alaila Kom 16 1/4° Ki 6 Kaul 25 paku ma ke
 Komohiki a hiki i kahi i hoomaka ia maia Apana 1 Eka 554 Anana

Januari 5 1852

R. W. Meyer
Surveyor

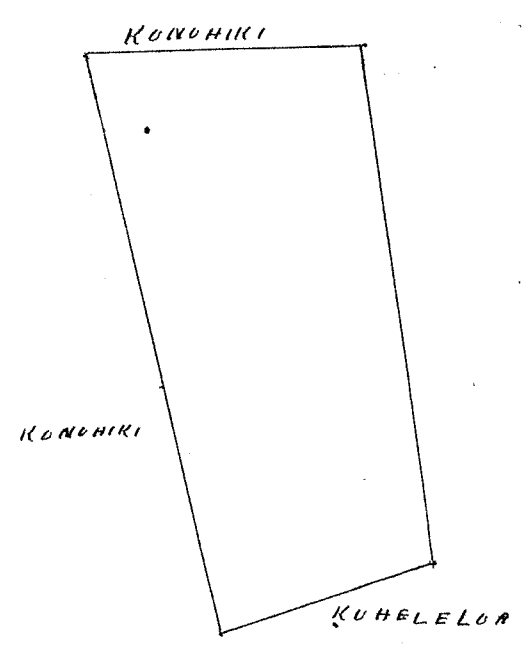
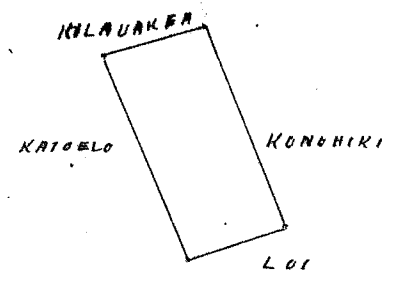
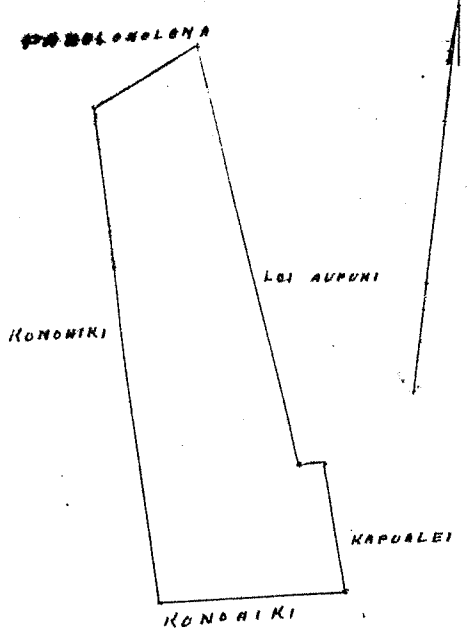

ANA 1/2 IN - 1 KAUL

Wm Pau Loa \$ 6.00

W. L. Lee

J. H. Smith
G. M. Robertson
J. Kekaulahao

Honolulu Pulai 17 1852
Yolu 4936 Kahoowaha

Ohia Molokai

Kahoowaha Ohia ili o Haalulu Molokai
 E hoomaka ma ke Pahi Aina oia aina a e holo ana Ak 75° 41' 27" Kaul, ma ke Konohiki
 alaila Ak 48° 40' 25" Kaul, ma ke Pahi alaila Ak 32 1/4° 40' 26" Kaul, ma ke Konohiki
 alaila Ak 5 1/2° 41' 29" Kaul ma ke Kahoowahi, alaila Ak 75 1/2° 40' 38" Kaul ma ke Kahoowahi
 a hiki i Kahi i hoomaka ia Maia a Spana 4 Eka 800 Anana,
 Mei 15 1852

R. W. Meyer
Surveyor

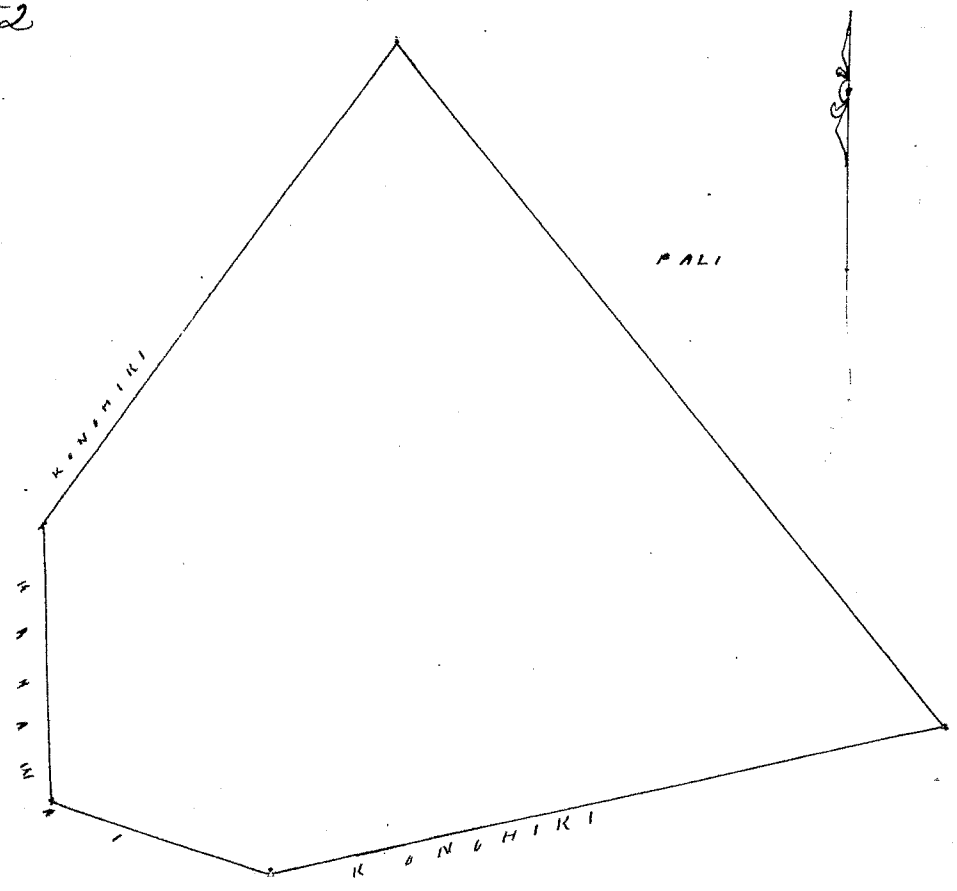

ANA 1/2 IN - 1 KAUL

Wm Pau Loa \$ 6.00

W. L. Lee

J. H. Smith
G. M. Robertson
J. Kekaulahao

Honolulu Pulai 17 1852
Yolu 9104 Kahoahane

Manowai Molokai

Kahoahane Manowai ili Kapaakohukili Molokai
 E hoomaka ma ke Pahi Kom Ak. via Lira e holo ana Ak 72 1/4° 41' 14" Kaul ma ke Kapuku
 alaila Ak 4° 41' 07" Kaul, ma ke Manukani Ak 37° 41' 01" Kaul ma ke Manukani alaila
 Ak 82° 41' 07" Kaul ma ke Kahoowahi alaila Ak 70° 41' 55" Kaul ma ke Kahoowahi alaila Ak 6 3/4°
 41' 05" Kaul ma ke Konohiki alaila Komoana 3,40 Kaul ma ke Loko alaila Ak 35° 41' 04" Kaul
 ma ke Kepano alaila Ak 33° 40' 39" ma ke Kepano a hiki i Kahi i hoomaka
 ia Maia a Spana 244 anana
 Mei 15 1852

R. W. Meyer
Surveyor

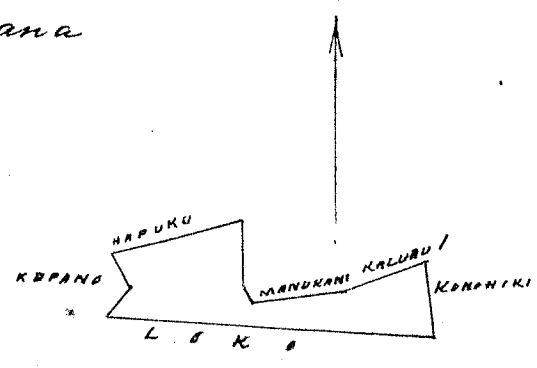

ANA 1/2 IN - 1 KAUL

Uku Pau Loa # 4, 00

W. L. Lee

J. H. Smith
G. M. Robertson
J. Kukanahao

Honolulu Iulai 17, 1852

Keleu 4185 Kaluan 2

Manowai Molokai

Kaluan 2 E hoomaka ma ke kahi Hihina Hema oia aina a e holo ana He 67 1/4 Kaula
0,70 Kaula ma ke Kuaana alaila He 22 1/2 Kaula 0,74 1/2 Kaula ma ke Kepano alaila He 16 Kaula 0,70 Kaula
ma ke Konoiki alaila He 27 Kaula 0,69 Kaula ma ke Hihopawa a hiki i Kahi i hoomaka ia maia apama
60 anana,

Apana 2 E hoomaka ana ma ke kahi Hema oia aina a e holo ana He 34 1/2 Kaula 1,20 Kaula
ma ke pali alaila He 18 1/2 Kaula 4,90 Kaula ma ke pali alaila He 7 1/2 Kaula 0,60 Kaula ma ke Pui alaila
He 21 Kaula 5,90 Kaula ma ke Kapaawai a hiki i Kahi i hoomaka ia maia Apana 961 Anana
Mii 15, 1852

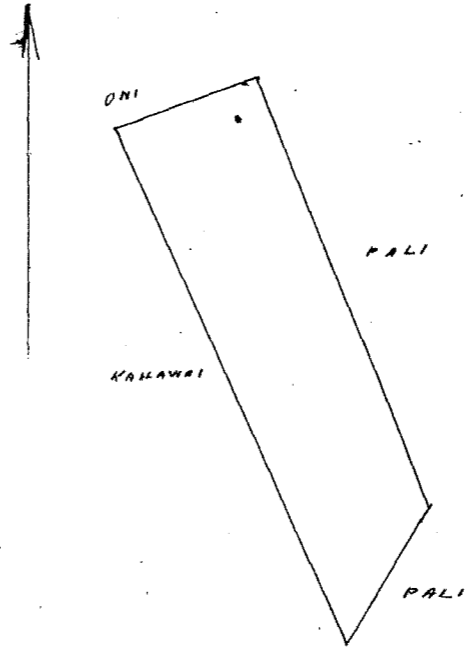
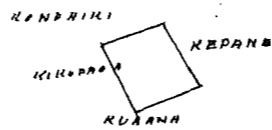

R. M. Meyer
Surveyor

Ana 1/2 inia - 1 Kaulaha

60
961
4021
15 147 (43816)
15 1168

Uku Pau Loa # 5, 00

W. L. Lee

G. M. Robertson
J. H. Smith
J. Kukanahao

Honolulu Iulai 17, 1852

Keleu 3197 Lokomaiikai + 785124

Puahala Molokai

Lokomaiikai Puahala He Iouwai Molokai
Apana 1 Pa E hoomaka ma ke kahi Kom Akau. Heia pa a e holo He 60 1/4 Kaula 5 Kaula
55 paku ma ke Heakaleha alaila He 25 Kaula 4 Kaula 1 paku ma ke Heapu alaila He 7 1/4
Kaula 5 Kaula 16 paku ma ke Konoiki alaila He 33 1/4 Kaula 5 Kaula 11 paku ma ke Kahi a hiki i Kahi
i hoomaka ia Maia Apana 1 Hea 692 Anana,

Apana 1 Pahala Ma Kaamola E hoomaka ma ke kahi Hihina Hema. Heia pa
a e holo He 12 1/4 Kaula 71 paku ma ke Konoiki alaila He 83 Kaula 60 paku alaila ma ke Konoiki
He 15 1/2 Kaula 66 paku ma ke Konoiki alaila He 88 1/4 Kaula 57 paku ma ke Kahi a hiki ma Kahi
i hoomaka ia Maia Apana 48 Anana
Nov 19 1851.

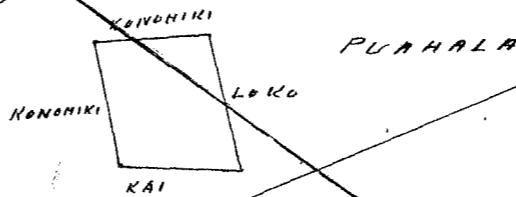

R. M. Meyer
Surveyor

Enama avou 486. V.S. award

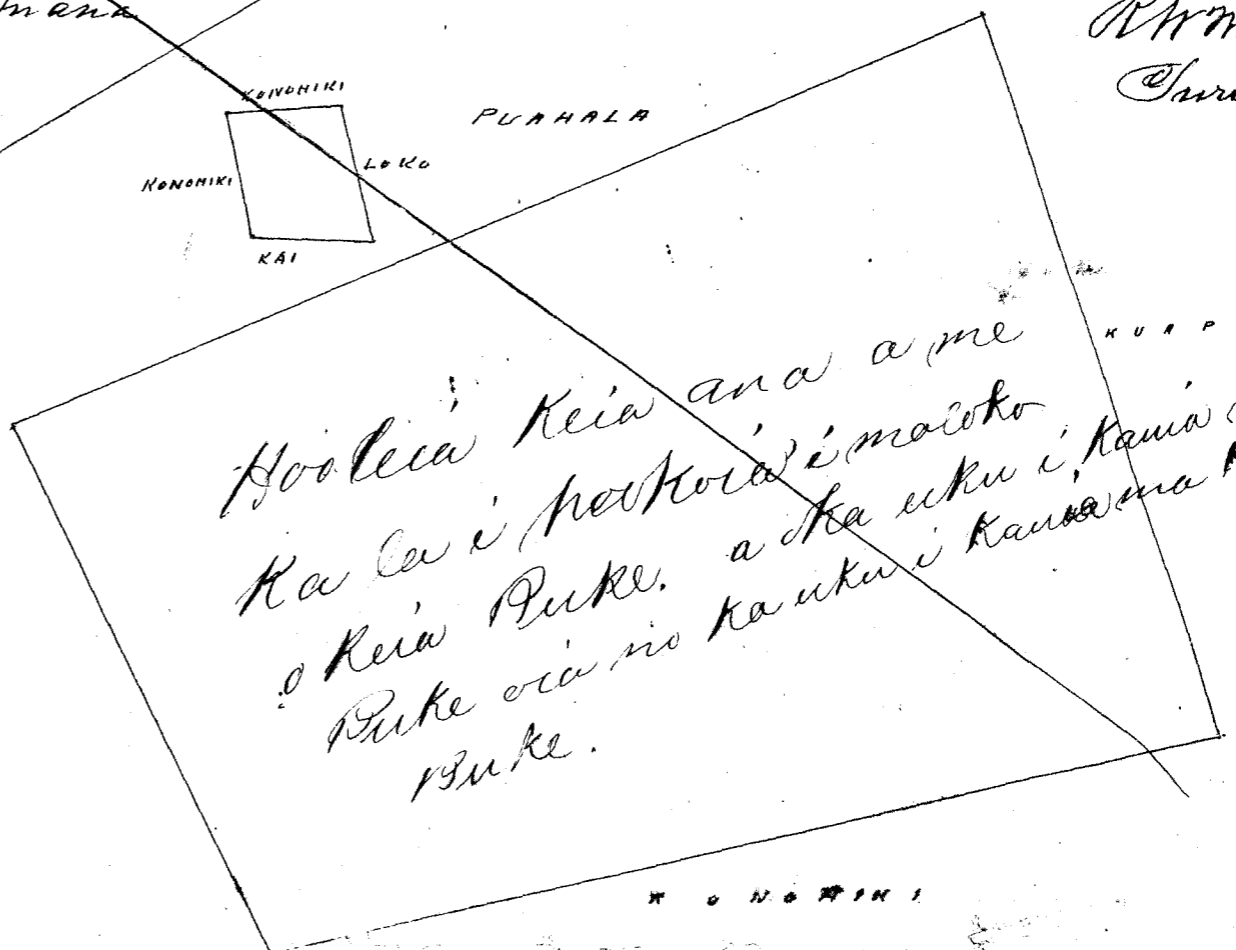

Hoolia Heia ana a me
Kaia i Heakaleha i maloko
o Heia Puke. a Heia i Kana ma Kea
Puke oia no kaia i Kana ma Kea
Puke.

Ana 1 inia - 1 Kaula

Uku Pau Loa \$ 5.00

G. M. Robertson

Honolulu Pulai 17 1852

J. Kikaulaha

Heleu 503 Kama

Moanui Molokai

Kama Moanui ili Makenanano Molokai

Apana 1 E hoomaka ma ke kiki Kikina Kama malalo ia aina e holo ana Ak 50 Hi 6th
66 ptk. ma ke alanui alaila Ak 26 1/4 Hi 3 Kaul 97 pautu, ma ke alanui alaila Ak 43 1/4
Hom 13 Kk 74 ptk. ma ke Kuhio alaila Ak 46 1/4 Hom 5 Kk 40 ptk. ma ke Kowhiki alaila Ak 43 1/4
Hi 15 Kk 00 ptk. ma ke Waialua a hiki i ka hoomaka ana, maia Apana 7 Eka 11 20 Anana

Apana 2 E hoomaka ma ke kiki Kik Kama, hia aina a e holo ana Ak 5 1/2 Hi 2 Kaul ma ke
Aupuni alaila Ak 80 1/2 Hom 7 Kaul, ma ka pali alaila Ak 65 Hi 7 Kaul 50 pautu, ma ka
pali a hiki i Kahi i hoomaka ia Maia Apana 8 53 Anana

Maraki 22 1852

R. M. Meyer
Surveyor

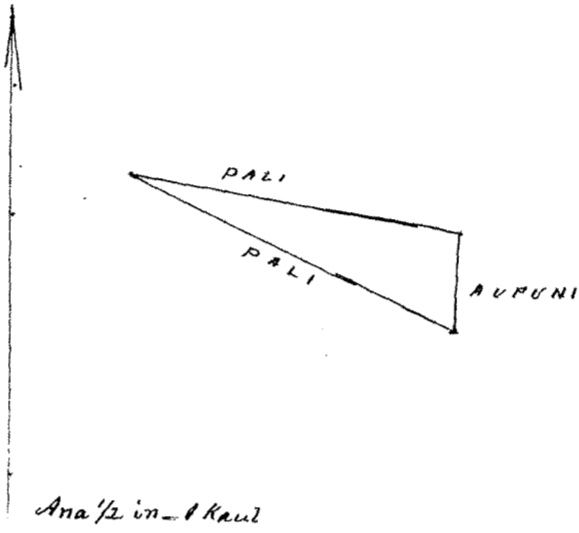
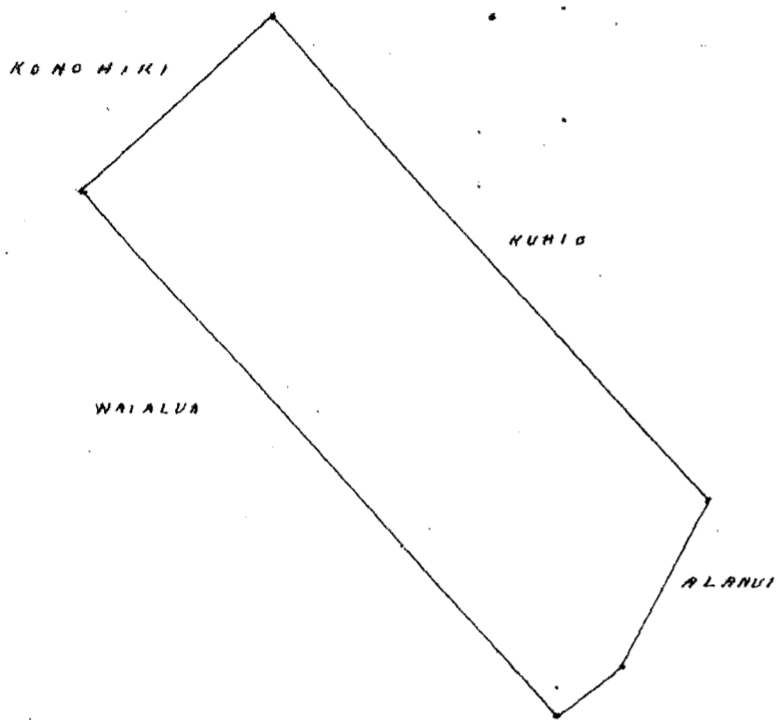

7.1120
853
1973
1200
88763

Uku Pau Loa \$ 7.00

W. L. Lee

D. H. Smith
G. M. Robertson
J. Kikaulaha

Honolulu Pulai 17 1852

Heleu 6634 Kahoika

Moanui Molokai

Kahoika Moanui Molokai ili Waiaa
E hoomaka ma ke kiki Kaul, ia aina a e holo ana Hom 30 1/4 Hom 7 Kaul ma ke pali
alaila Ak 53 Hi 7 Kaul 65 pautu, ma ke pali, Ak 57 1/4 Hi 3 Kaul 00 ptk. ma ke pali
a hiki i Kahi i hoomaka ia Maia Apana 1 Eka 48 Anana

Ioi ma ke Aupuni Ma loko hia Kaulana,
Maraki 24 1852

R. M. Meyer
Surveyor

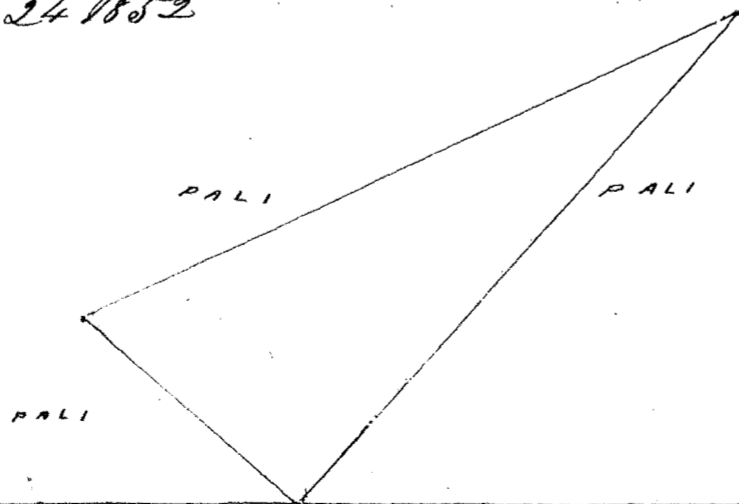

Uku Pau Loa \$ 5.00

W. L. Lee

G. M. Robertson
D. H. Smith

Hoelu 6636 Naueu

Moanui Molokai

57

Naueu Moanui ili. Kalama Molokai

Apana 1 E hoomaka ana ke kiki Akau oia aina a e holo, Kum 58 1/2 No 4 Kaul 57 pautu ma ke Kuhu alaila Kum 56 No 6 Kaul 52 pautu ma ke Honohiki alaila Ak 58 1/2 No 2 Kaul 80 pautu ma ke Honohiki alaila Ak 44 No 6 Kaul 05 pautu, ma ke Kahawai a hiki i Kahi i hoomaka ia maia Apana 2 Eka 221 Anana

Apana 2 E hoomaka ana ma ke kiki Honohana Akau, o keia aina a e holo ana Ke 58 1/2 No 8 Kaul ma ke pali alaila Ke 33 1/2 No 1 Kaul ma ke Anupuni alaila Ak 58 1/2 No 8 Kaul ma ke pali, alaila Ak 33 1/2 No 1 Kaul ma ke Honohiki a hiki i Kahi i hoomaka ia, Maia Apana 96 Anana

Apana 3 E hoomaka ma ke kiki Kikina Akau, o keia aina a e holo ana, Ke 79 1/2 No 1 Kaul, 59 pautu ma Kahawai alaila Ke 56 1/2 No 2 Kaul 22 pautu ma ke pali, alaila Ak 10 1/2 No 1 Kaul, 57 pautu ma Kahawai a hiki ma Kahi i hoomaka ia Maia Apana 151 Anana,

Maraki 24 1852

R. W. Meyer, Surveyor

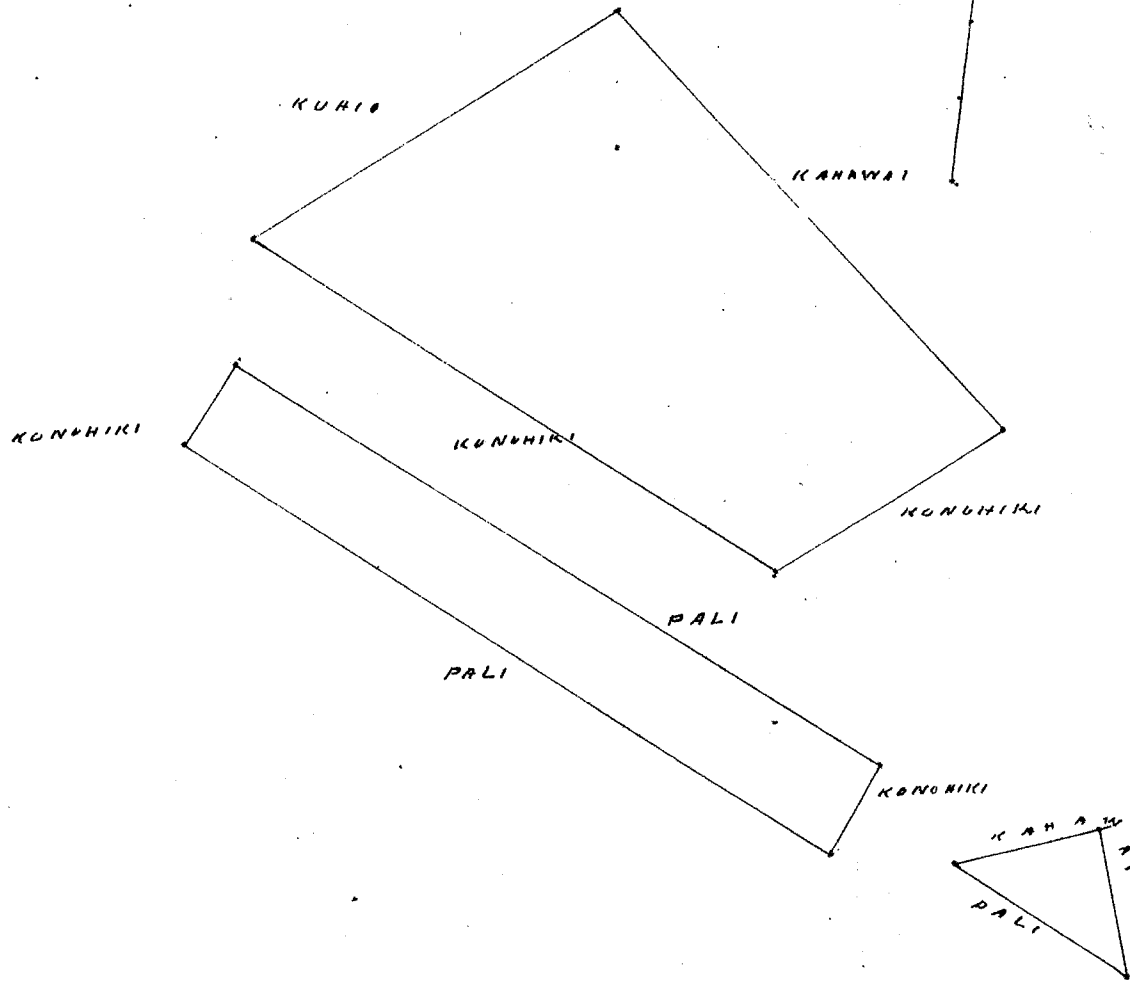

Maia 1/2 in. Kaul

2E 221 A
 960
 151
 1332
 1210
 3E 132

Wm Pau Loa \$ 6,00

W. L. Lee

W. M. Robertson

J. H. Smith

Honolulu Iulai 11 1852

J. Kaulahao

Hoelu 4475C Oni

Moanui Molokai

Apana 1 E hoomaka ana ma ke kiki Kikina Kama, oia Lii a e holo ana Kum 68 No 936 Kaulaha ma ke Konohiki alaila Ak 72 1/2 No 134 Kaul, ma ke Konohiki alaila Ak 64 No 958 Kaul, ma ke Konohiki alaila Ak 26 1/4 No 952 Kaul ma ke Konohiki alaila Ak 89 1/4 No 137 Kaul ma ke Kuhu alaila Ak 9 1/4 No 813 Kaul ma ke Kuhu, alaila Ak 74 1/2 No 942 Kaul ma ke Kuhu, alaila Ak 4 1/2 No 123 Kaul, ma ke Keaki alaila Ke 32 1/2 No 112 1/2 Kaul ma ke Keaki, a hiki i Kahi i hoomaka ia ma ia Apana 250 Anana,

Apana 2 E hoomaka ana ma ke kiki Kama oia aina a e holo ana Ak 45 1/2 No 928 Kaul, ma ke Kepano Ak 27 1/4 No 964 Kaul ma ke Kepano alaila Ke 57 No 927 Kaul ma ke Keaki alaila Ke 29 1/4 No 970 Kaul, ma ke Keaki a hiki i Kahi i hoomaka ana ma ia Apana 22 Anana

Apana 3 E hoomaka ana ma ke kiki Kama oia Kula, a e holo ana, Ak 31 1/2 No 160 Kaul ma ke Kahuau 2, alaila Ak 18 1/2 No 492 Kaul ma ke Pali, alaila Ke 11 1/2 No 115 Kaul ma ke Pali Ke 2 1/4 No 492 Kaul ma Kahawai a hiki i Kahi i hoomaka ia Maia Apana 101 Anana

Mai 15, 1852

R. W. Meyer, Surveyor



Ana 1/2 in = 1 Kauli

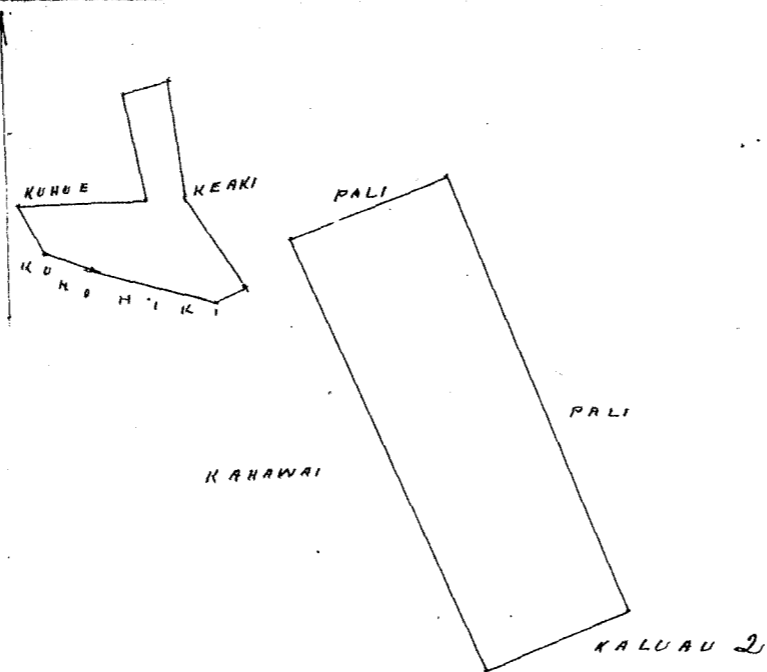

Wai Pau Loa # 5. 00 W. L. Lee

J. H. Smith
G. M. Robertson
J. Kekaulahao

Honolulu July 17 1852

Heleu 4574 Isaia

Moanui Molokai

Isaia Moanui ili o Kelepani Molokai

Apana 1 E hoomaka ma ke kahi Komohana Akau, maanei. keia aina a e holo ana He 29 1/2 He 3 Haul, 16 pautu ma ke Kahawai, alaila He 49 3/4 He 45 pautu, ma ke Kahawai alaila He 40 1/4 He 1 Haul, ma ke Hanahanui alaila He 39 He 480 Haul, ma ke Pali alaila He 65 He 91 pautu ma ke Kuhie a hiki i kahi i hoomaka ia Maia Apana 474 Anana,

2, Loi mo ke aupuni maloko o keia Muleana

Apana 2, E hoomaka ma ke kahi Aikina Hema mauka ia aina a e holo ana He 57 1/4 He 11 Haul, 15 pautu ma ke Aupuni alaila He 35 He 4 Haul 08 pautu ma ke Pali alaila He 67 1/2 He 10 Haul, 53 pautu ma ke Aupuni alaila He 54 1/2 He 2 Haul 51 pautu ma ke Kuhie a hiki i kahi i hoomaka ia ma ia Apana, 3 Cha 477 Anana,

Maraki 24 1852

R. W. Meyer,
Surveyor.

RUPUNI

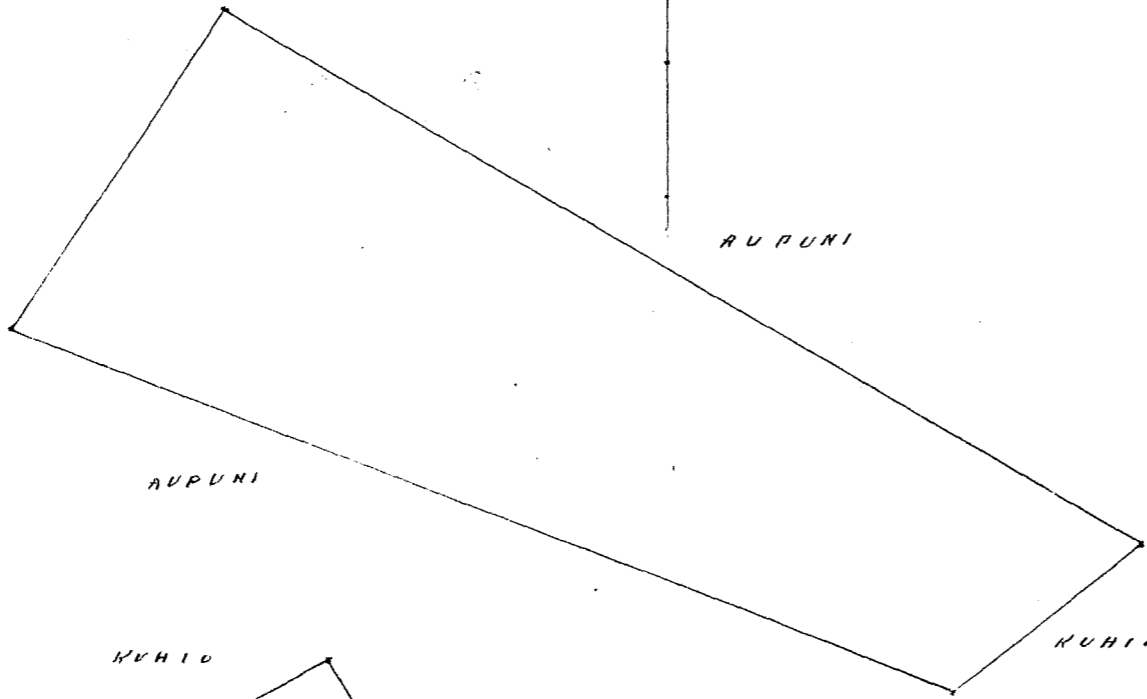

KUHIE

KAHAWAI

PALI

KAHAWAI

Ana 1/2 in = 1 Kauli

474
3. 477
3. 951

Wai Pau Loa # 6 - W. L. Lee

G. M. Robertson
J. H. Smith
J. Kekaulahao

Honolulu July 17 1852

Keolu 8921 Kumu + 608 7

Kumimi Molokai

Kumu Kumu i'i. Kumu Molokai

E hoomaka ana ma ke kahi Nihina Hema oia aia a e holo ana, Ak 27 1/4' Ki Kaul, 20 paku ma ke Konoiki alaila Ak 68' Kom 2 Kaul, 43 paku, ma ke Kahawai alaila He 30 1/4' Kom 1 Kaul 42 paku, ma ke Luka, alaila He 72' Ki 2 Kaul, 55 paku, ma ke pali a hiki i kahi hoomaka ia ma ia Apana, 584 Anana

Maraki 25 1852

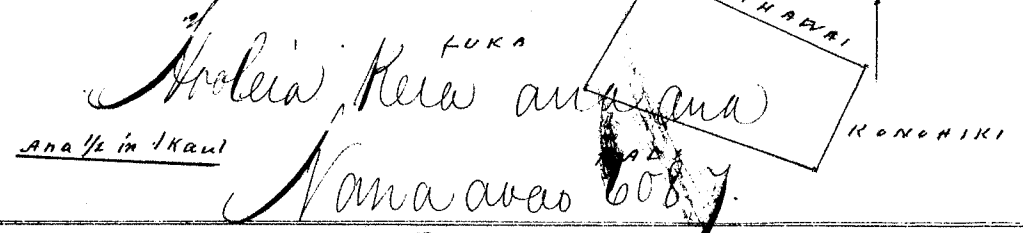

R. W. Meyer
Surveyor

Kumu Kumu i'i
Kumu Molokai
608

Wm Pau Loa & W. L. Lee

Honolulu Julai 17 1852

J. H. Smith
G. M. Robertson
J. Kekaulahao

Keolu 5216 Penopeno

Kumimi Molokai

Penopeno i'i Kahi Kumimi Molokai

E hoomaka ana ma ke kahi Komohana Kaul, oia aia a e holo ana, Ak 81' Kom 1 Kaul, 12 paku, ma ke Paha alaila Ak 88 1/4' Ki 1 Kaul 12 paku, ma ke Kahawai alaila Ak 84 1/2' Ki 2 Kaul 18 paku, ma ke Kahawai, alaila He 87' Ki 2 Kaul, 07 paku, ma ke Kahawai, He 12 1/2' Kom 2 Kaul, 16 paku ma ke Luka, alaila He 89' Kom 3 Kaul, 90 paku, ma ke pali a hiki i kahi hoomaka ia ma ia Apana, 1073 Anana

Maraki 25, 1852

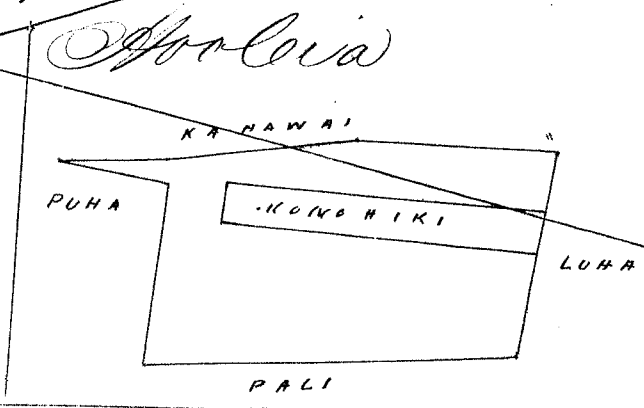

R. W. Meyer
Surveyor

Enawa awa 503. Vol. 7. awards Books

Ana 1/2 in 1 Kaul

Wm Pau Loa & W. L. Lee

Honolulu Julai 17 1852

J. H. Smith
G. M. Robertson
J. Kekaulahao

Keolu 7685 Luka + 500 7

Kumimi Molokai

Luka Kumimi i'i. Anawa Molokai

E hoomaka ana ma ke kahi Nihina Hema oia aia a e holo ana, Ak 30 1/4' Ki 1 Kaul, 42 paku ma ke Kaulou, alaila Ak 58 3/4' Ki 2 Kaul, 74 paku ma ke Kahawai alaila He 12 1/2' Kom 2 Kaul, 53 paku ma ke Penopeno alaila He 84' Ki 2 Kaul 20 paku ma ke pali a hiki i kahi hoomaka ia ma ia Apana, 575 Anana

E 3 Loi no ke Konoiki maloko i'i Kule ana,
Maraki 25, 1852

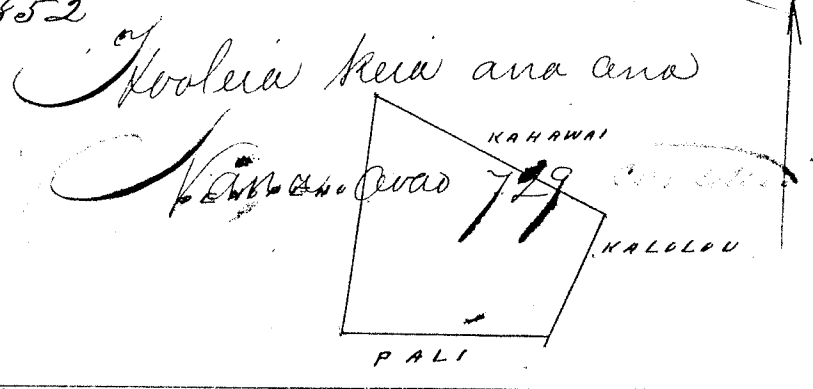

R. W. Meyer
Surveyor

Wm Pau Loa & W. L. Lee

G. M. Robertson
J. H. Smith
J. Kekaulahao

Honolulu Julai 17, 1852

Heleu 5074 Hauhanui

Kumimi Molokai

Hauhanui Kumimi Molokai

Pahala E hoomaka ma ke kahi Komohana Hema via aina a e holo ana, Ak 49 1/2 Hi 4 Kaul 18 pautu, ma ke alanui alaila Ak 27 1/2 Kom 2 Kaul, 76 pautu, ma ke Komohiki alaila Ak 38 1/2 Kom 4 Kaul, 94 pautu ma ke Komohiki alaila Ak 42 1/2 Hi 1 Kaul, 78 pautu ma ke Kulis a hiki i kahi hoomaka ia ma ia Apana 1207 Anana,

Maraki 24 1852

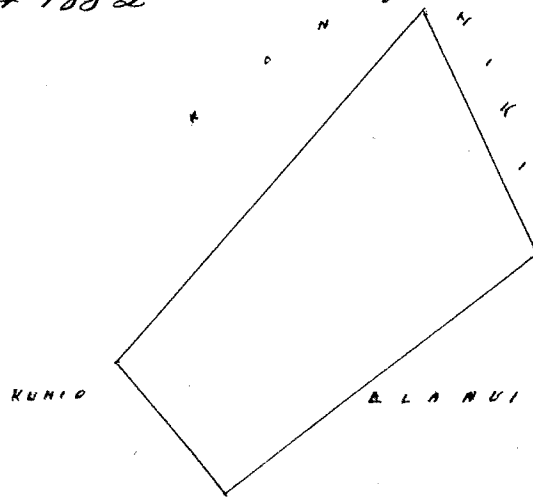

R. M. Meyer
Surveyor
1/2 in = 4 Kaul.

Uku Pau Loa \$ 4.00

W. L. Lee

J. H. Smith
G. M. Robertson
J. Kikaulaha

Honolulu Julai 17 1852

Heleu 7687 Leiona

Kumimi Molokai

Leiona Kumimi ili Molokai
E hoomaka ma ke kahi Kikina Hema via aina a e holo ana, Ak 15 1/2 Hi 2 Kaul, 55 pautu, ma ke ~~Kulis~~ ^{Komohiki} alaila Ak 80 1/2 Kom 1 Kaul 58 pautu, ma ke Kahawai alaila Ak 58 Kom 2 Kaul 42 pautu ma ke Kahawai alaila Ak 17 Hi 2 Kaul, 45 pautu, ma ke Kahawai alaila Ak 75 1/2 Hi 2 Kaul 40 pautu ma ke pali a hiki i kahi hoomaka ia ma ia Apana ~~1012~~ Anana Cili ana 3 Puda, 11 Perka.

5 Loi ou ke Komohiki ma keia Leiona
Maraki 25 1852

~~1/2 in = 4 Kaul~~

2 In. 1 Kaul.

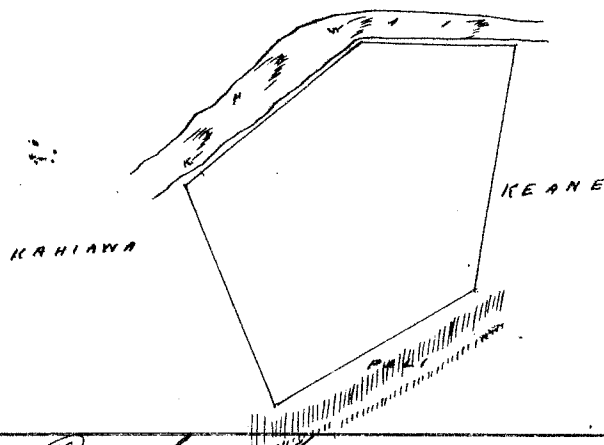

Molokai Oct. 1853

W. H. Base
Shropshorn hoo

Uku Pau Loa \$ 4.

W. L. Lee

G. M. Robertson
J. H. Smith

Honolulu Julai 17 1852

J. Kikaulaha

Heleu 7617^B Puha

Kumimi Molokai

Puha Kumimi ili Kamuhine Molokai
E hoomaka ma ke kahi Kikina via aina a e holo ana, Ak 76 1/2 Kom 2 Kaul, ma ke Penopenu alaila Ak 81 Kom 1 Kaul, 12 pautu ma ke Penopenu alaila Ak 67 1/2 Hi 1 Kaul 50 pautu ma ke ~~Penopenu~~ ^{Komohiki} alaila Ak 87 Hi 2 Kaul 18 pautu, ma ke Penopenu alaila Ak 28 1/2 Hi 2 Kaul, 62 pautu, ma ke Jhu a hiki i kahi hoomaka ia ma ia Apana ~~37~~ Anana Cili ana 1 Puda.

Maraki 25 1852

2 Kaul 1 in.

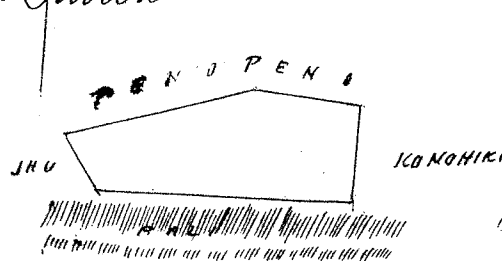

R. M. Meyer
Surveyor

Molokai Oct. 1853

W. H. Base. Shropshorn hoo.

Ulu Pau Loa \$4.00
 W. L. Lee
 G. M. Robertson
 J. H. Smith

Honolulu Iulai 17 1852. J. Kaulahao
 Heleu 4571 Skeole + 31077 ✓ Waialua Motokai
 Skeole Waialua ili. Heu Motokai

~~Apana 1. Chomaka ana ma ke kahi Heua ia aina a e holo ana Ak 55 1/4° Hi 15 paku ma ka
 Kahakulani, alaila Ak 20° Kom 2 Kaulahao 94 paku ma ka Komohiki alaila He 6° Hi 2 Kaulahao 15 paku
 ma ka Komohiki a hiki i kahi i hromaka ia Maia Apana 139 Anana.~~

~~Apana 2. Chomaka ana ma ke kahi Heua ia aina a e holo ana Ak 52 1/4° Hi 3 Kaul, 82 paku ma
 ka Lima alaila Ak 55 1/4° Kom 3 Kaul 84 paku ma ka Kahawai alaila He 50° Kom 2 Kaul, 77 paku
 ma ka Pule, alaila He 39° Hi 3 Kaul, 61 paku ma ka Pili-pili a hiki i kahi i hromaka ia maia Apana
 1 Eka, 221 Anana.~~

~~Apana 3. Chomaka ana ma ke kahi Heua ia aina a e holo ana, Ak 29° Kom 2 Kaul
 ma ka Kahawai, alaila Ak 61° Hi 1 Kaul 50 paku ma ka Komohiki alaila He 29° Hi 2 Kaul 00
 paku, ma ka pali alaila He 61° Kom 1 Kaul, 50 paku, ma ka pali a hiki i kahi i hromaka ia Ma
 ia Apana 363 Anana.~~

Maraki 23, 1852

R. W. Meyer
 Surveyor

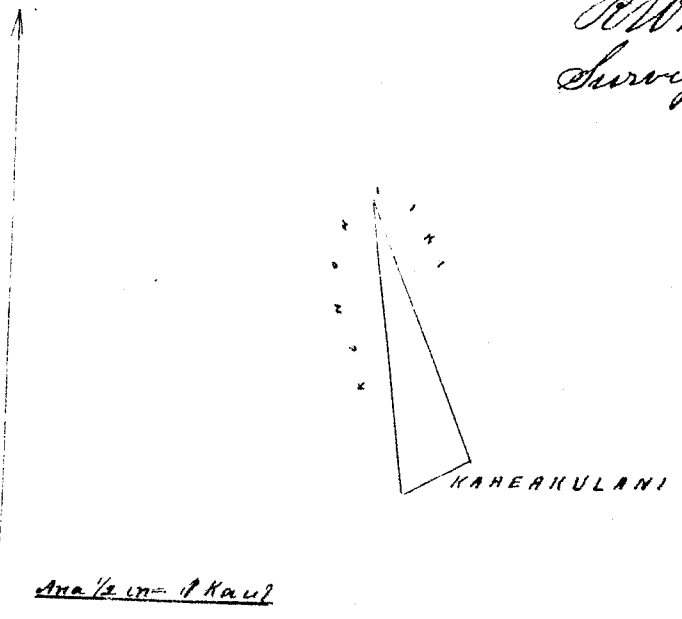
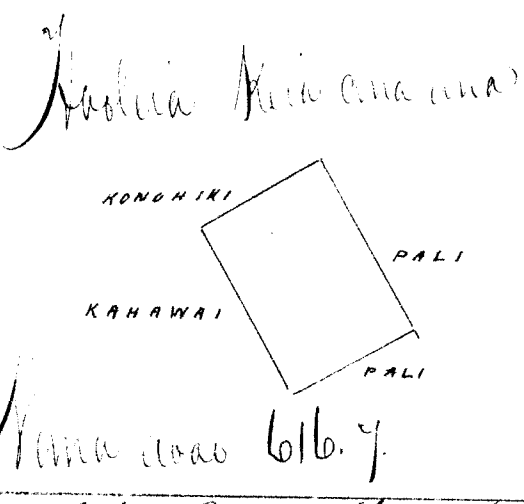
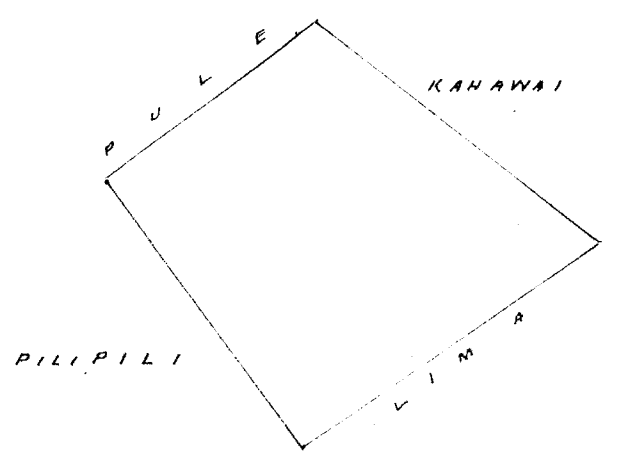

Ulu Pau Loa \$5.00
 W. L. Lee

J. H. Smith
 G. M. Robertson
 J. Kaulahao

Honolulu Iulai 17 1852
 Heleu 537 Kahukahukai + 6577 ✓ Waialua Motokai
 Kahukahukai Waialua ili. Papa Motokai

~~Apana 1. Chomaka ana ma ke kahi Komohana Heua maonei i keia aina a e holo ana Ak 44 1/2° Hi 8 Kaul
 23 paku ma ka Kaa alaila Ak 39° Kom 60 paku ma ka pali alaila He 47 1/2° Kom 8 Kaul 90 paku ma ka Komohiki
 alaila He 75° Hi 1 Kaul, He 11 paku ma ka Kahawai a hiki i kahi i hromaka ia maia Apana 837 Anana.~~

~~Apana 2. Chomaka ana ma ke kahi Aikina Heua malalo ia aina a e holo ana Ak 59° Kom 3 Kaul
 8 paku ma Kahawai alaila Ak 33° Kom 1 Kaul, 90 paku ma Kahawai alaila Ak 58° Hi 1 Kaul 95 paku
 ma ka Pomano alaila He 55° Hi 4 Kaul, 12 paku ma ka pali alaila He 35 1/2° Kom 2 Kaul, 30 paku
 ma ka Komohiki a hiki i kahi i hromaka ia Maia Apana 1 Eka, 53 Anana.~~

1 Loi Kalo ma ka Komohiki maloko. keia Heleana,
 Maraki 24 1852

R. W. Meyer
 Surveyor

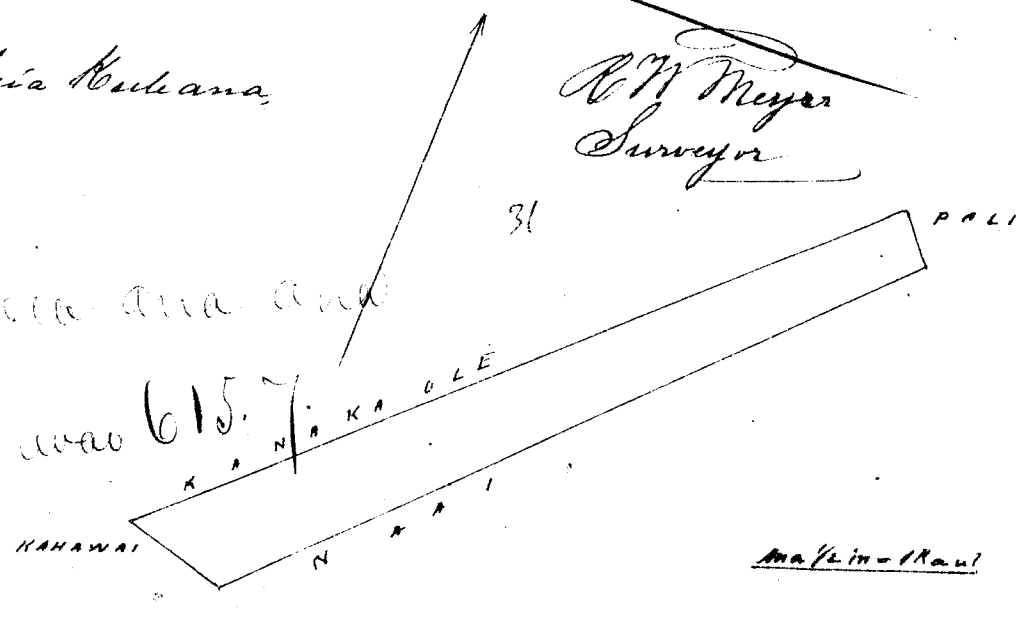
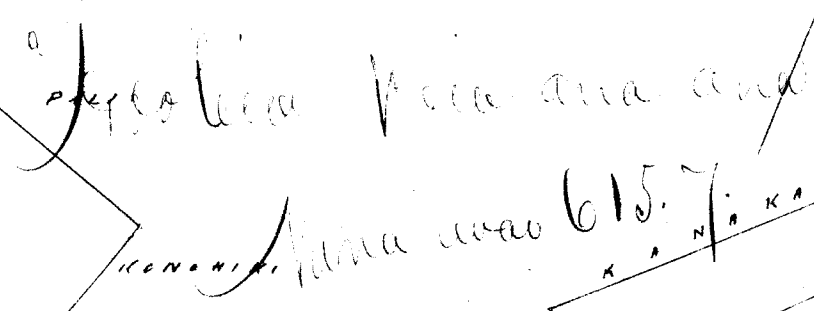
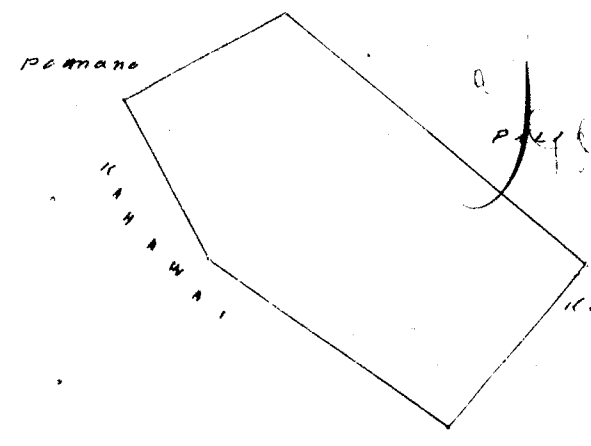

Honolulu Julai 11, 1852

Hele 4757 Napoka + eny.

Waialua Molokai

~~Napoka Waialua ili o Hokuau Molokai
E hoomaka ma ke kiki Hikina Ima analala, keia aina a e holo ana, Ak 4 1/4 Kom 5 Kaul 95 pki
ma ke Kauli alaila Ak 39 1/4 Hi 4 Kaul 40 paku ma ke Hanakaole alaila He 42° Hi 6
Kaul 85 paku ma ke pali alaila He 57 1/2 Kom 4 Kaul 34 paku ma ke Kauli a hiki i
Ka hoomaka ana. Maia Apana 2 Eka 956 Anana~~

~~Loi no ke Konoehiki ma aloko o keia Kaulana,
Marahi 23, 1852~~

~~R. W. Meyer
Surveyor~~

HANAKAOLE

PALI

KAWILI

NAIIO

Ana 1/2 in. = 1 Kaul

W. L. Lee

G. M. Robertson

J. H. Smith

J. Kikaulaha

Honolulu Julai 17, 1852

Hele 4610 Tulu + 612470

Waialua Molokai

Tule Waialua ili o Mahoe, Molokai

~~Apana 1 E hoomaka ma ke kiki Hikina Ima analala via aina a e holo ana, Ak 23 1/4 Kom 6 Kaul
87 paku ma ke Kauli alaila Ak 38 1/2 Kom 5 Kaul 84 paku ma ke Palimu alaila He 88 1/2 Hi
3 Kaul 50 paku ma ke Kahakulani alaila He 34° Hi 5 Kaul 36 paku ma Kahawai
alaila He 43 1/4 Kom 2 Kaul 20 paku ma ke Iheole alaila He 68 1/4 Kom 60 paku ma
ke Iheole a hiki i kahi i hoomakaia, maia Apana 1 Eka 850 Anana~~

~~Loi Konoehiki ma aloko o ke Apana 1 o keia Kaulana,~~

~~Apana 2 E hoomaka ma ke kiki Ima via aina a e holo ana Ak 57 1/4 Kom
1 Kaul 89 paku ma ke pali alaila Ak 64° Hi 2 Kaul 24 paku ma Kahawai alaila
He 52 1/4 Hi 1 Kaul 27 paku ma Kahawai alaila He 50° Kom 1 Kaul 86 paku ma
ke Kahakulani, a hiki i kahi i hoomakaia maia Apana 2 Eka 348 Anana~~

~~Marahi 23, 1852~~

~~R. W. Meyer
Surveyor~~

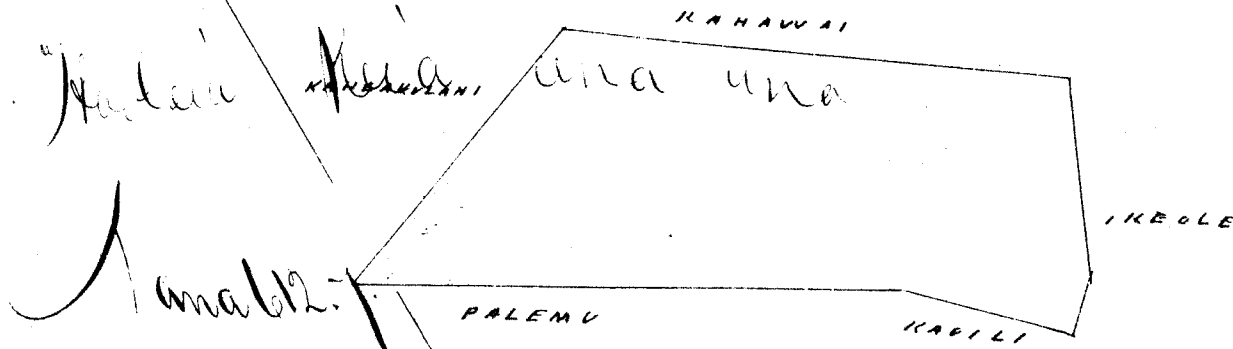
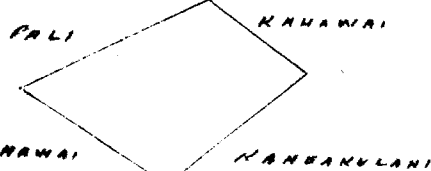

Ana 1/2 in. = 1 Kaul

W. L. Lee
G. M. Robertson
J. H. Smith

Honolulu Iulai 17 1852

J. Kekaulahas

Heleu 4022 Daniel

Waiakua Molokai

Daniel Waiakua Molokai

Pahale Chomaka ma ke hiki Hikina Kema via pa a e holo ana Ak 45 1/2 Hikina 107 Kaulahas ma ke Konoehiki alaila Ak 28 Kom 115 1/2 Kaulahas ma ke Naimihale alaila Ak 33 Kom 77 Kaulahas ma ke Alanui alaila He 28 1/2 Kom 86 Kaulahas ma ke Konoehiki alaila He 54 1/2 Kom 34 Kaulahas ma ke Konoehiki alaila He 48 Hei 2.08 Kaulahas a hiki i kahi i hoomaka ia Ma ia Apana 22.5 Anana Maraki 28, 1852

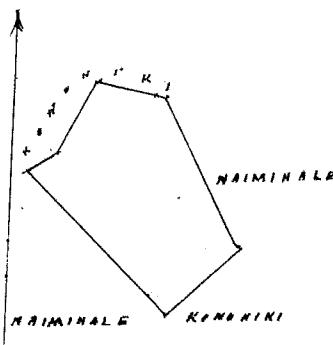

R. W. Meyer
Surveyor

W. L. Lee

J. H. Smith
G. M. Robertson
J. Kekaulahas

Honolulu Iulai 17 1852

Heleu 4079 Kuapu

Waiakua Molokai

Kuapu Waiakua ili. Kinole Molokai

Chomaka ma ke hiki Hikina Akau, via aima a e holo ana He 44 Hei 149 Kaulahas ma ke Konoehiki alaila He 49 1/2 Kom 422 Kaulahas ma ke Hei alaila Ak 40 1/2 Kom, 77 Kaulahas ma ke Kauhawai alaila Ak 39 3/4 Hei 168 Kaulahas ma ke Konoehiki alaila Ak 47 1/4 Kom 53 Kaulahas ma ke Konoehiki alaila Ak 46 Hei 311 Kaulahas ma ke Konoehiki a hiki i ka hoomaka ana Ma ia Apana 75 1/2 Anana

Maraki 23, 1852

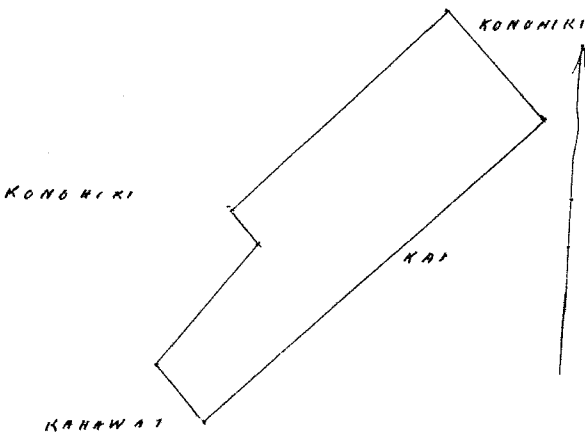

R. W. Meyer
Surveyor

W. L. Lee

G. M. Robertson
J. H. Smith

Honolulu Iulai 17 1852

J. Kekaulahas

Heleu 4082 Kamai

Waiakua Molokai

Kamai Waiakua ili. Kuwamaunapopo Molokai

Apana 1 Hale Chomaka ma ke hiki Hikina Akau via Loi a e holo ana, Ak 39 1/2 Kom 1 Kaul 69 paunku ma ke Kaulaha alaila He 42 1/2 Kom 2 Kaul, 90 paunku ma ke Naimihale & Konoehiki alaila He 41 1/2 Hei 1 Kaul 66 paunku ma ke Konoehiki alaila Ak 48 1/4 Hei 2 83 paunku ma ke Loko a hiki i kahi i hoomaka ia Ma ia Apana 580 Anana

Apana 2 Hale 4 Kula, Chomaka ma ke hiki Hei via aima a e holo ana, Ak 34 Kom 1 Kaul, 21 1/2 paunku ma ke Konoehiki alaila He 51 Kom 1 Kaul, 37 paunku ma ke Naimihale alaila He 48 Hei 1 Kaul, 02 paunku ma ke Kauhawai alaila Ak 67 Hei 1 12 paunku ma ke Konoehiki a hiki i kahi i hoomaka ia Ma ia Apana 169 Anana

Maraki 23 1852

R. W. Meyer
Surveyor

6A

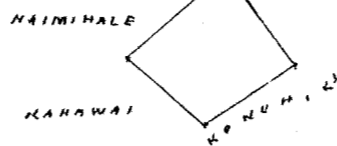
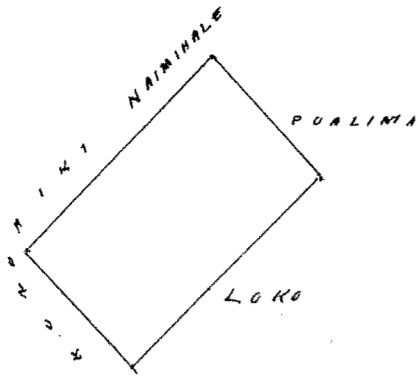

Area in 1 KAUL

Uhu Pau Loa # 4, W. L. Lee

J. H. Smith
G. M. Robertson
J. Kekaulahao

Honolulu July 17, 1852

Heleu 4710 Meheula

+ 61517

Waialua Makakai

Meheula Waialua Hi. Nohona Makakai

~~Apana 1 E hoomaka ana oia ke kahi Komohana oia aia a e holo ana, Ak 38 1/2 Hei 2 Kaul 50 paku ma ke Naonea
 alaila He 48 Hei 5 Kaul, 15 paku, ma ke Pali alaila He 42 1/2 Kom 1 Kaul, 50 paku ma ke Komohiki alaila Ak 47 1/2
 Kom 2 Kaul, 57 paku, ma ke Kahawai alaila Ak 40 1/2 Kom 3 Kaul, 22 paku ma ke Kahawai alaila a hiki i kahi
 i hoomaka ia Maia Apana 848 Apana~~

~~Apana 2 E hoomaka ana oia ke kahi Akau oia aia a e holo ana, He 44 Kom 1 Kaul 47 paku ma ke Naonea
 alaila He 43 Hei 1 Kaul, 31 paku ma ke Pali alaila Ak 47 Hei 1 Kaul, 45 paku, ma ke Paakai alaila He 39 1/2 Kom 1
 Kaul, 42 paku ma ke Komohiki a hiki i kahi i hoomaka ia Maia Apana 237 Apana.~~

~~Apana 3 E hoomaka ana ke kahi Komohana Kona oia aia a e holo ana, Ak 39 3/4 Kom 1 Kaul
 54 paku, ma ke Komohiki alaila Ak 68 3/4 Hei 4 Kaul, 46 paku ma ke Paakai alaila He 42 Hei 1 Kaul 21 paku
 ma ke Komohiki alaila He 2 Kom 4 Kaul, 43 paku ma ke Komohiki a hiki i kahi i hoomaka ia Maia
 Apana, 726 Apana.~~

~~Apana 4 E hoomaka ana oia ke kahi Kona Komohana oia aia a e holo ana Ak 37 1/2 Kom 89 paku
 ma ke Li Komohiki alaila Ak 47 Hei 1 Kaul 26 paku, ma ke Komohiki alaila He 41 1/4 Hei 80 paku ma ke Komohiki
 alaila He 44 Kom 4 Kaul 33 paku ma ke Komohiki a hiki i kahi i hoomaka ia Maia Apana 134 Apana~~

~~Apana 5 E hoomaka ana oia ke kahi Kihuna Akau, onabato oia aia a e holo ana, He 35 Hei 6
 Kaul, 90 paku ma ke Paakai alaila He 55 Hei 1 Kaul, 20 paku ma ke Poniwhua alaila Ak 35 Hei 8 Kaul
 23 paku, ma ke Naonea, alaila Ak 67 1/2 Kom 1 Kaul, 22 paku ma ke Pali a hiki i kahi i hoomaka ia
 Maia Apana 705 Apana~~

Maraki 23, 1852,

R. W. Meyer
Surveyor

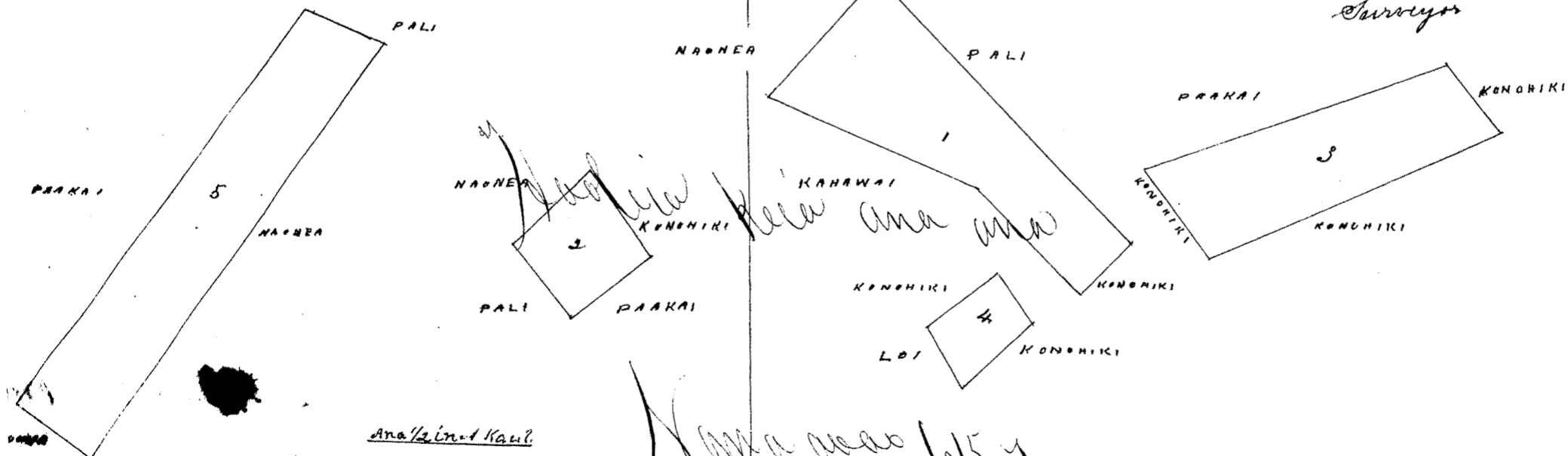

Kona ana ana 61517

Uhu Pau Loa # 6, W. L. Lee

W. L. Lee
G. M. Robertson
J. H. Smith
J. Kekaulahao

Honolulu July 17, 1852

Heleu 3826 Natu

Waialua Molokai

Natu Waialua ili o Kanani Molokai

Apana 1 Choomaka ana ma ke kahi Komohana Kama, keia aina a e holo ana Ak 37 1/2 Hi 9 Kaul 83 paku, ma ke Paloku alaila He 45 1/2 Hi 1 Kaul, 38 paku, ma ke Pali alaila He 43 1/2 Kom 9, Kaul 60 paku, ma ke Kaanana alaila Ak 71 Kom 36 1/2 paku ma ke Kahawai ahiki i kahi i hoomaka ia Maia Apana 1002 Anana.

1 Loi no Konoehiki maloko o keia Kouleana.

Apana 2 Choomaka ana ma ke kahi Kama o keia Aina a e holo ana Ak 36 Hi 2 Kaul, 40 paku ma ke Anana alaila Ak 28 Kom 2 Kaul, 75 paku, ma ke Pali alaila He 30 1/2 Kom 3 Kaul 75 paku ma ke Paloku alaila He 58 Hi 2 Kaul, 13 paku, ma ke Kahawai a hiki i kahi i hoomaka ia Maia Apana 844 Anana.

Apana 3 Choomaka ana ma ke kahi Komohana Kama o keia Aina a e holo Ak 47 1/2 Hi 1 Kaul 00 paku ma ke Konoehiki alaila Ak 42 1/2 Hi 2 Kaul, 50 paku ma ke Konoehiki alaila Ak 47 1/2 Hi 1 Kaul 00 paku ma ke Konoehiki alaila He 42 1/2 Kom 2 Kaul 50 paku, ma ke Konoehiki a hiki i kahi i hoomaka ia Maia Apana 1/4 Eka

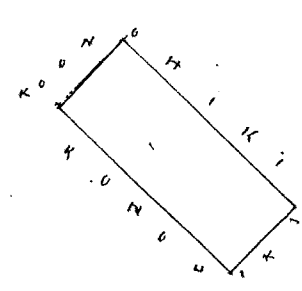
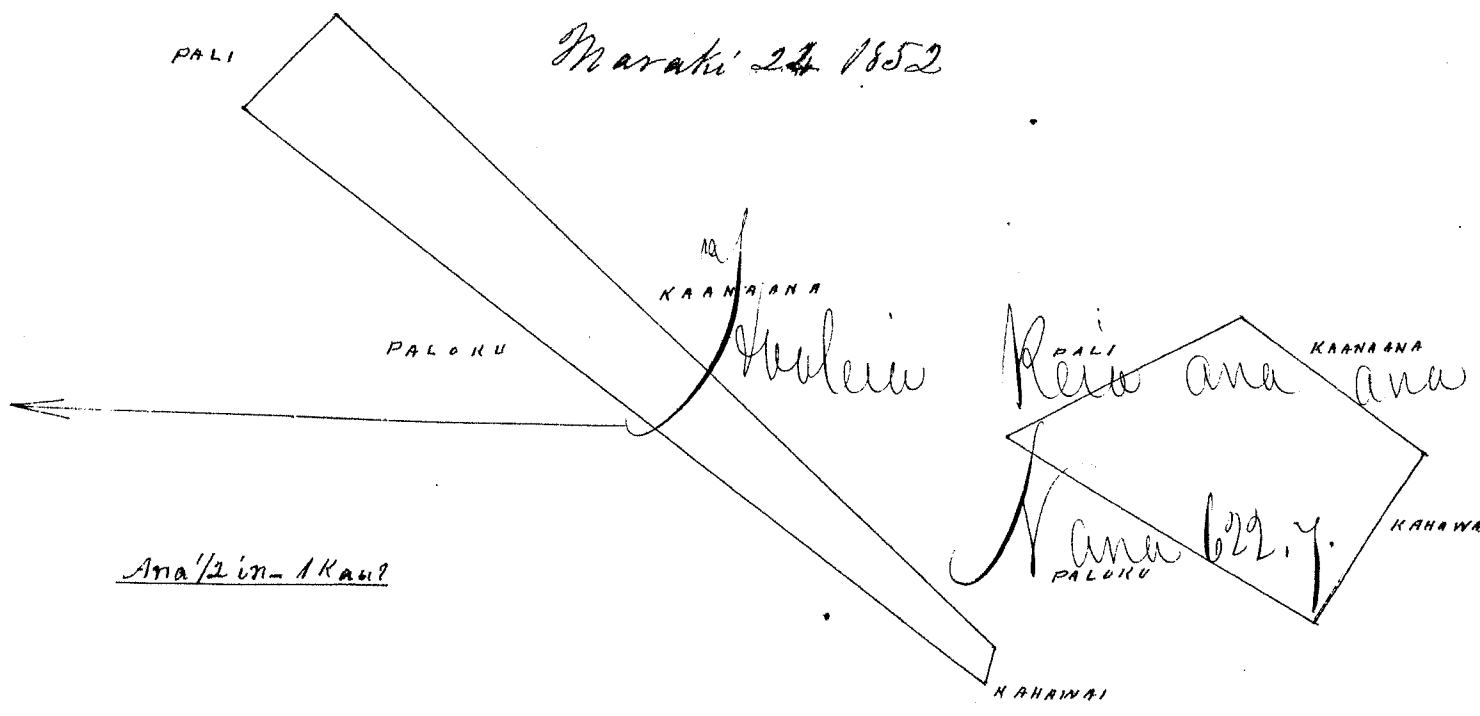

Uku Pau Loa \$ 6.00

W. L. Lee

J. H. Smith
G. M. Robertson
J. Schaulbach

Honolulu Iulai 17 1852

Heleu 5185 Kanakaole

Waialua Molokai

Kanakaole Waialua Ili Mahalo Molokai

Apana 1 Choomaka ana ma ke kahi Komohana Kama, maanei ia aina a e holo ana, Ak 46 3/4 Kom 79 paku ma Kahawai alaila Ak 45 3/4 Hi 8 Kaul, 60 paku ma ke Mahuka alaila He 61 Hi 1 Kaul, 10 paku ma ke Pali alaila He 47 1/2 Kom 8 Kaul, 90 paku ma ke Kahukahukai a hiki i ke hoomaka ana, Maia Apana 974 Anana.

Apana 2 Choomaka ana ma ke kahi Kama o keia Aina a e holo ana, Ak 39 1/2 Hi 4 Kaul, 70 paku ma ke Kahawai alaila Ak 49 1/2 Hi 4 Kaul 65 paku ma ke Pali alaila He 30 1/4 Hi 3 Kaul, 20 paku ma ke Kaai alaila He 23 Hi 3 Kaul, 98 paku ma ke Kahawai alaila Ak 3 Kom 1 Kaul, 20 paku, ma ke Kauli alaila Ak 10 1/2 Hi 1 Kaul 00 paku ma ke Kauli alaila He 59 1/2 Hi 1 Kaul 70 paku ma ke Kauli a hiki i kahi i hoomaka ia Maia Apana 2 Eka 345 Anana.

1 Loi no ke Konoehiki maloko o keia Kouleana.
Maraki 23 1852

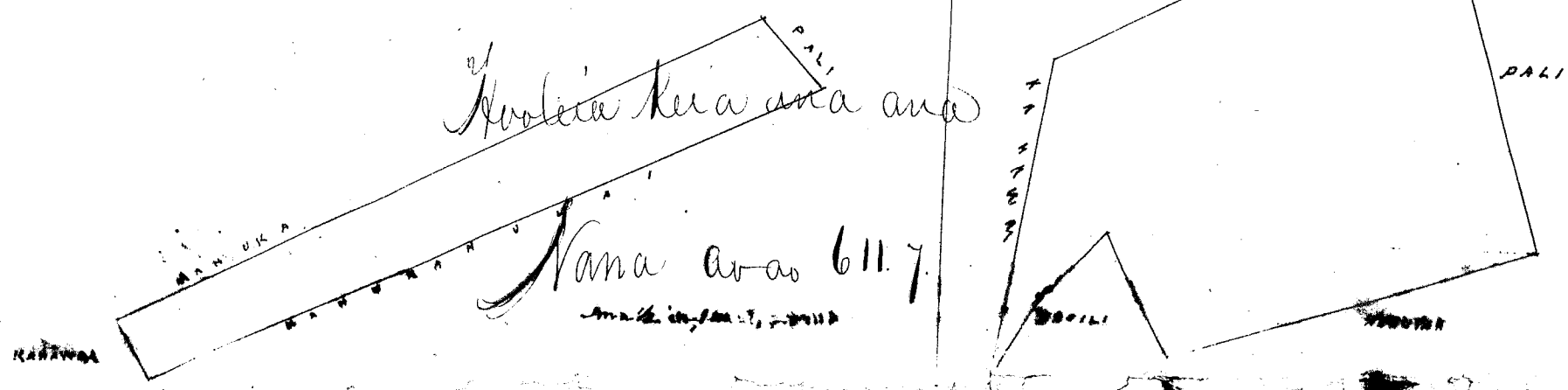

Uku Pau Loo \$6.00

W. L. Lee
G. M. Robertson

Honolulu Julai 11 1852

J. Kekaulaha

Heleu 4519 Kaamana + 6127

Waialua Molokai

Kaamana Waialua Ili Kapuaka Molokai

Apana 1. Chomaka ma ke kahi Komohana Hema maloko. kua aina a e holo ana, Ak 45 1/2 Hei 9 Kaul 64 pa
ma ke Kahu alaila He 36 1/2 Hei 80 paunku ma ke Pali alaila He 44 Kom 9 Kaul, 20 paunku ma ke Lili alaila
Ak 66 1/2 Kom 34 Paunku ma ke Kahawai a hiki i kahi i hoomaka ia Maia Apana 976 Anana,

1 Loko no ke Komohiki maloko. kua Kealeana,

Apana 2. Chomaka ana ma ke kahi Komohana Ahanu, oia aina a e holo ana Ak 36 Hei 2
Kaul, 40 paunku, ma ke Kahu alaila He 50 1/2 Hei 6 Kaul, 34 paunku, ma ke Pali alaila He 63 1/2 Kom 4 Kaul
30 paunku, ma ke Nahuina alaila Ak 31 1/2 Kom 4 Kaul, 55 paunku, ma ke Kahawai a hiki i kahi i hoomaka ia
Maia Apana 1 Eka 962 Anana,

Maraki 24 1852

NALE

J. W. Meyer
Surveyor

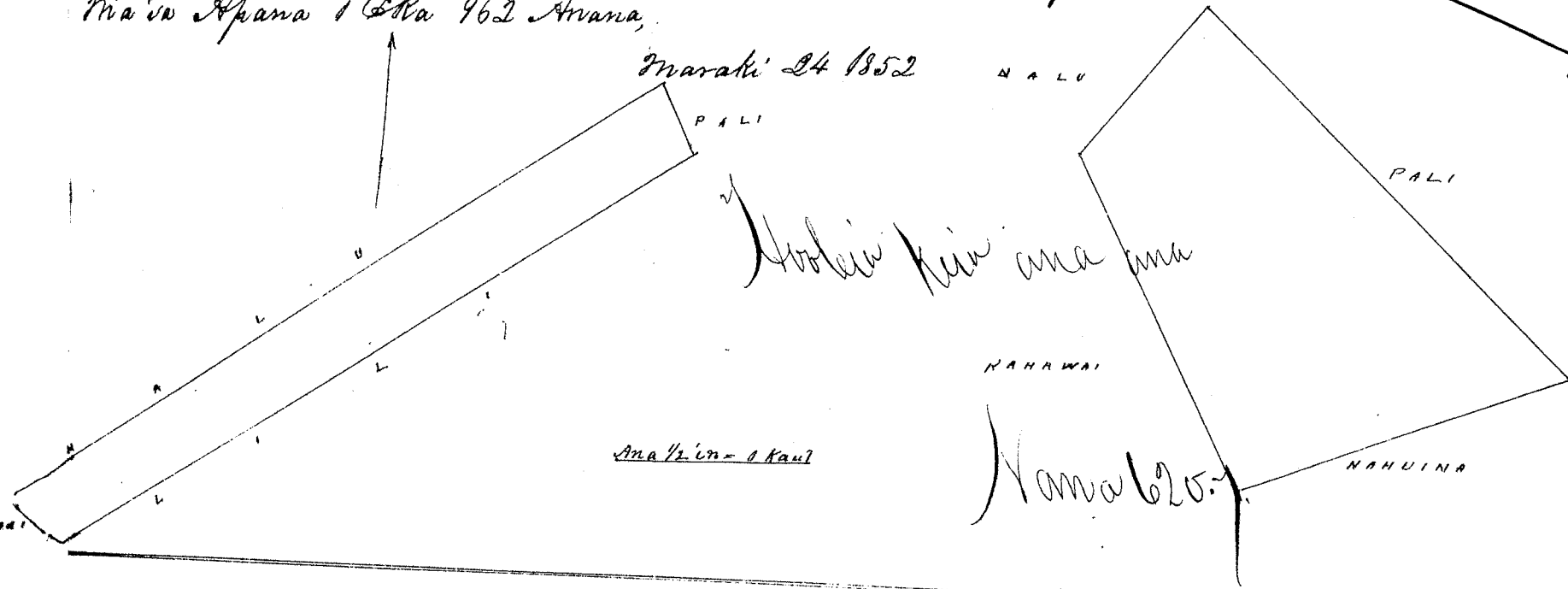

Uku Pau Loo \$5

W. L. Lee

J. M. Smith
G. M. Robertson
J. Kekaulaha

Honolulu Iune 11 1852

Heleu 6560 Pouahi

Waialua Molokai

Pouahi Waialua Molokai Ili o Ninole

Apana 1. Chomaka ma ke kahi Komohana, oia aina a e holo ana, He 36 1/2 Hei 183 Kaul, ma ke Maule
alaila Ak 56 Hei 106 Kaul ma ke Komohiki alaila He 39 Hei 87 Kaul ma ke Komohiki alaila Ak 48 1/4
Hei 180 Kaul, ma ke Komohiki alaila Ak 54 Kom 235 Kaul, ma ke Alanui alaila He 63 1/2 Kom 219
Kaul, ma ke Komohiki a hiki i kahi i hoomaka ia Maia Apana 659 Anana,

Apana 2. Chomaka ana ma ke kahi Fikina Ahanu, makai oia aina a e holo ana, Ak 36 1/2
Kom 155 Kaul ma ke Pali alaila He 57 1/2 Kom 448 Kaul ma ke Alanui alaila He 47 1/2 Kom 140 Kaul
ma ke Alanui alaila He 39 1/2 Hei 111 Kaul, ma ke Kahawai alaila Ak 57 1/2 Hei 580 Kaul, ma ke
Komohiki Maia Apana 904 Anana,

Maraki 25, 1852

NAULE

J. W. Meyer
Surveyor

No ke Komohiki ke kau mau wahi maloko
o keia kule ana, ma keia mau wahi 278 Anana
Sol. Kahunā.

ma 1/2 in = 1 Kaul

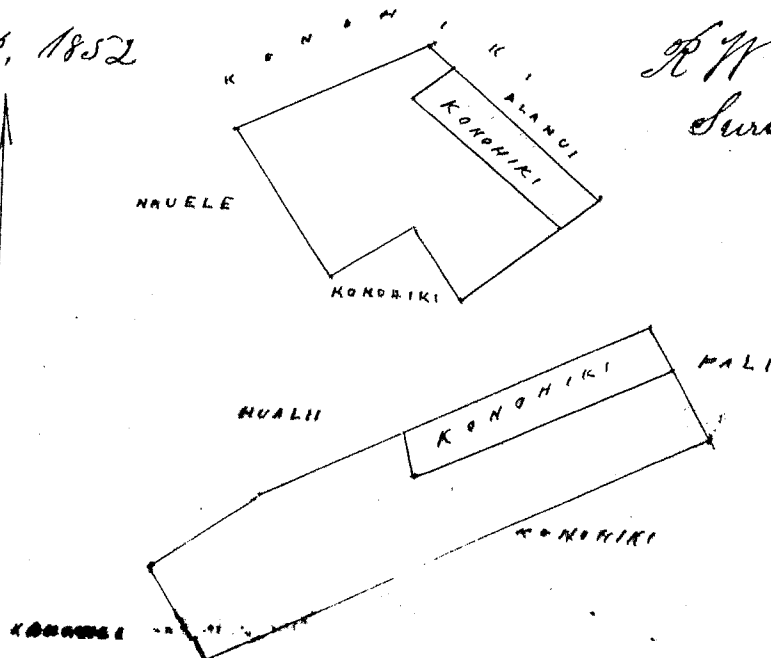

1563
1210
1833

uncertain whether
Komohiki share is
Calculated separate
or not

W. L. Lee
G. M. Robertson
J. H. Smith

Honolulu Oahu Julai 17 1852.

S. Kaulaheo

Volu 6288 Kealahamui + 60175

Honouliwai Molokai

Kealahamui Ili. Makaha, Honouliwai Molokai

Apana 1 E hoomaka ana ma ke kahi Komohana Kama, oia aina a e holo ana Ak 3 1/2 Ho 2 Kaul, 50 paku
ma ke Kahawai alaila He 58 1/2 Ho 3 Kaul 62 paku, ma ke Pali alaila He 35 Ho 50 paku ma ke Pali
alaila He 55 Ho 2 Kaul, 25 paku, ma ke Kahawai alaila Ak 75 Ho 2 Kaul, 26 paku ma ke Kahawai
a hiki i kahi i hoomaka ia ma ia Apana, 665 Apana,

1 Loi no ke Aupuni malohu, keia Kuleana,

Apana 2, E hoomaka ma ke kahi Hikina Kama oia aina a e holo ana, Ak 32 Ho 6 Kaul, 65 paku
ma ke Kahawai alaila He 58 Ho 50 paku ma ke Pali alaila He 13 Ho 3 Kaul, ma ke Pali alaila,
He 46 1/2 Ho 4 Kaul, ma ke Pali alaila Ak 58 Ho 50 paku, ma ke Pali alaila hiki i kahi i hoomaka
ia ma ia Apana, 804 Apana,

Apana 3, E hoomaka ana ma ke kahi Kama oia aina a e holo ana, Ak 44 1/2 Ho 1 Kaul, 17 paku
ma ke Kahawai alaila He 74 Ho 1 Kaul, 84 paku, ma ke Pali alaila He 73 1/2 Ho 1 Kaul, 84
00 paku, ma ke Kahawai a hiki i kahi i hoomaka ia ma ia Apana 122 Apana,

Apana 4, E hoomaka ana ma ke kahi Akau Komohana, oia aina a e holo ana, He 60 Ho 10
Kaul, ma ke Aupuni, alaila He 30 Ho 2 Kaul, ma ke Aupuni alaila Ak 60 Ho 10 Kaul, ma ke Aupuni
alaila Ak 30 Ho 2 Kaul, ma ke Aupuni a hiki i kahi i hoomaka ia ma ia Apana 2 Eka
Maraki 25 1852;

J. W. Meyer Surveyor

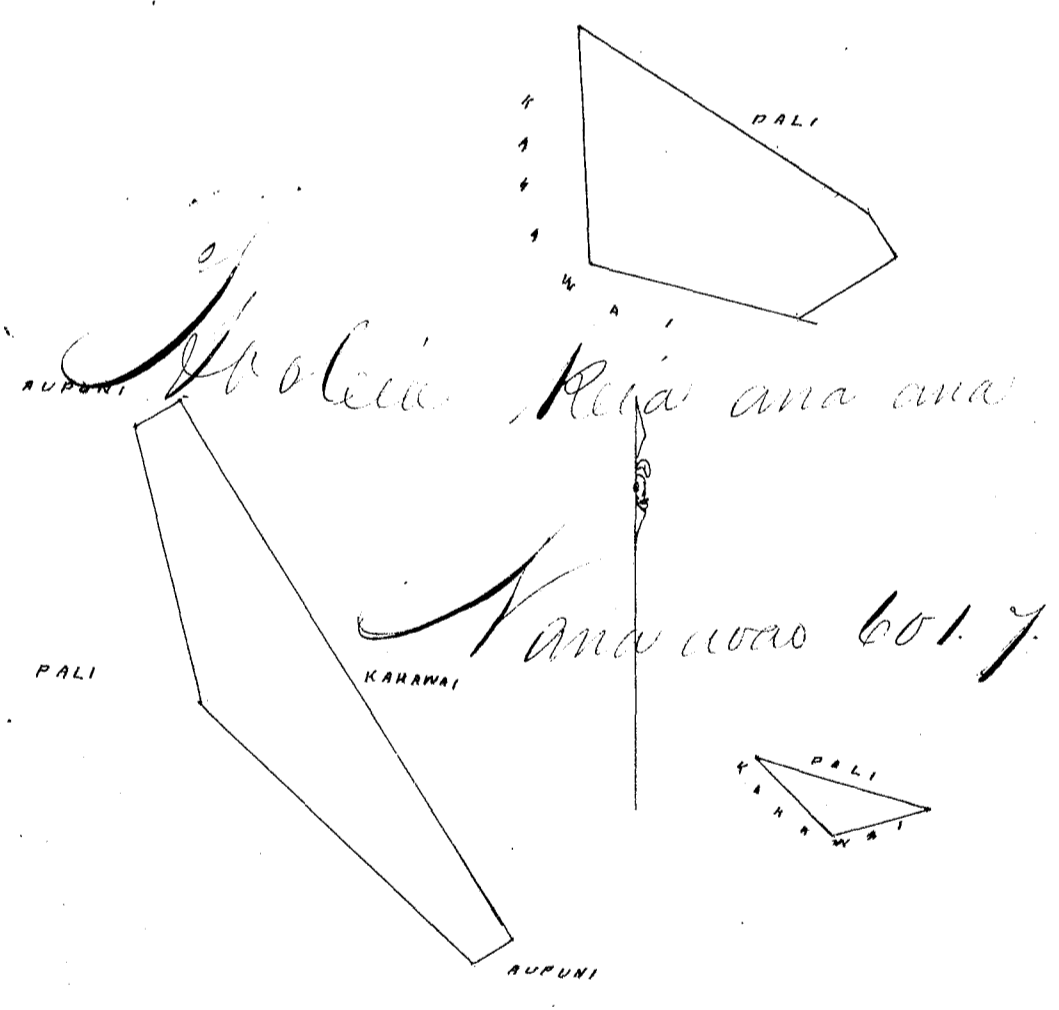

Ma 1/2 in - 1 Kaul

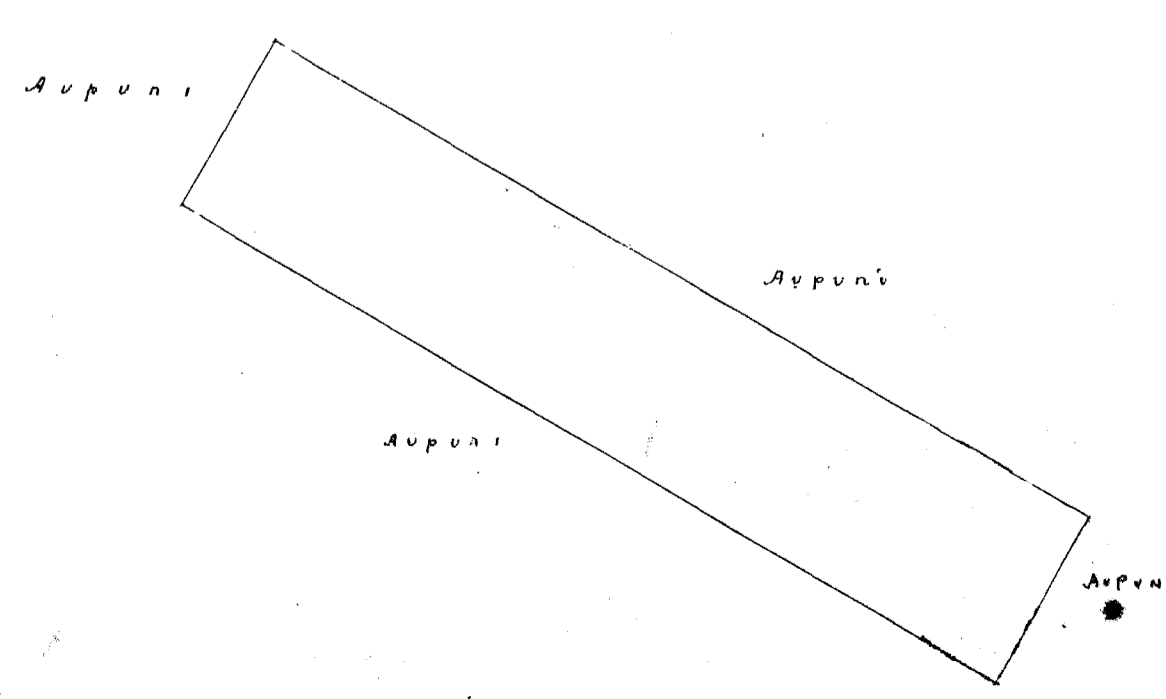

Wm Pau Loa # 5, ..

W. L. Lee

J. H. Smith
G. M. Robertson
J. Sekaulahao

Honolulu Iulai 17 1852

Hulu 3841 Pakaka

Waialua Molokai

Pakaka, Waialua Molokai

Apawa 1 Ii, E hoomaka ana ma ke kiki Hihina Akau, ma kai via aina a e holo ana, Ak 55°
Kom 67 paku, ma ke Daniel, alaila He 46 1/2° Kom 6 Kaul, 25 paku, ma ke Kuapu alaila He 42 1/2° He 41
paku, ma Kahawai alaila Ak 49° He 6 Kaul, 40. Paku, ma ke Naimihale a hiki i kahi i hoomaka ia
Maia Apawa 332 Anana,

Apawa 2, E hoomaka ana ma ke kiki Hihina Akau, ma kai via aina a e holo ana, Ak 21 1/4°
Kom 5 Kaul, 56 paku, ma ke Konoiki alaila Kom 68 1/4° Kom 2 Kaul, 50 paku, ma ke Maiania alaila
He 21 1/4° He 5 Kaul, 56 paku, ma ke Pali alaila Ak 68 1/4° He 2 Kaul, 50 paku ma ke Konoiki
a hiki i kahi i hoomaka ia Maia Apawa 1 Eka 823 Anana,

Maraki 23, 1852

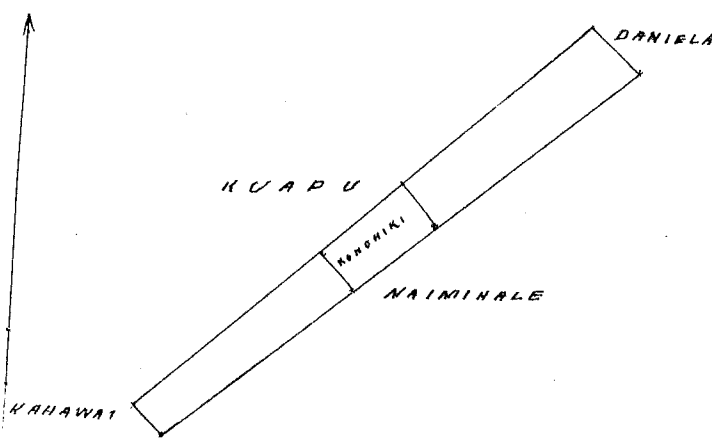
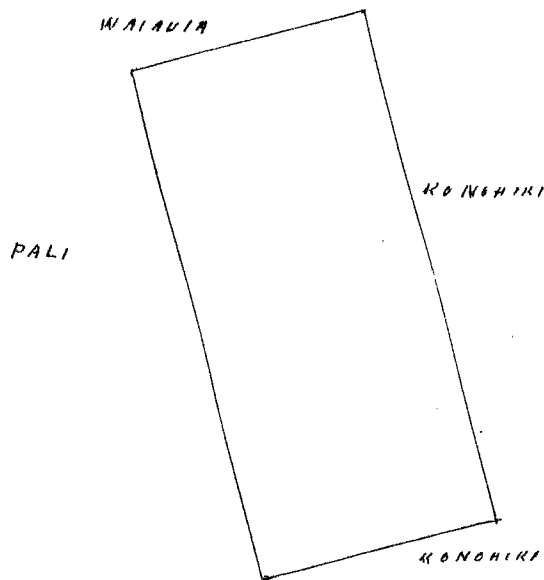

R. W. Meyer
Surveyor.

Ana 1/2 in = 1 Kaul.

332
E-823
1. 1855

Wm Pau Loa # 5, ..

W. L. Lee

J. H. Smith
G. M. Robertson
J. Sekaulahao

Honolulu Iulai 17 1852

Hulu 3818 Palohu

Waialua Molokai

Palohu, Waialua ili, Kawane Molokai

Apawa 1 E hoomaka ana ma ke kiki Hihina Akau ma kai via aina a e holo ana Ak 65 1/4° Kom
35 1/2 paku, ma ke Kariti alaila Ak 37° He 10 Kaul, ma ke Nais alaila He 45 1/4° He 38 paku,
ma ke Pali alaila He 37 1/4° Kom 7 Kaul, 83 pku, ma ke Nahu a hiki i kahi i hoomaka ia
Maia Apawa, 431 Anana,

Apawa 2, E hoomaka ana ma ke kiki Akau, ma kai via aina a e holo ana, Ak 37° Kom 6 Ak
85 pku, ma ke Kahawai alaila Ak 85° He 1 Kaul, 04 paku, ma ke Kahawai alaila Ak 74° He 3 Ak
88 paku ma ke Konoiki alaila He 28° He 4 Ak, 06 pku, ma ke Pali alaila He 32 1/4° Kom 4 Ak
26 pku, ma ke Nahu a hiki i kahi i hoomaka ia Maia Apawa 2 Eka 505 Anana,

1 Ii ma ke Konoiki ma aloki, heia Kuleana,

Maraki 24 1852

KAHAWAI

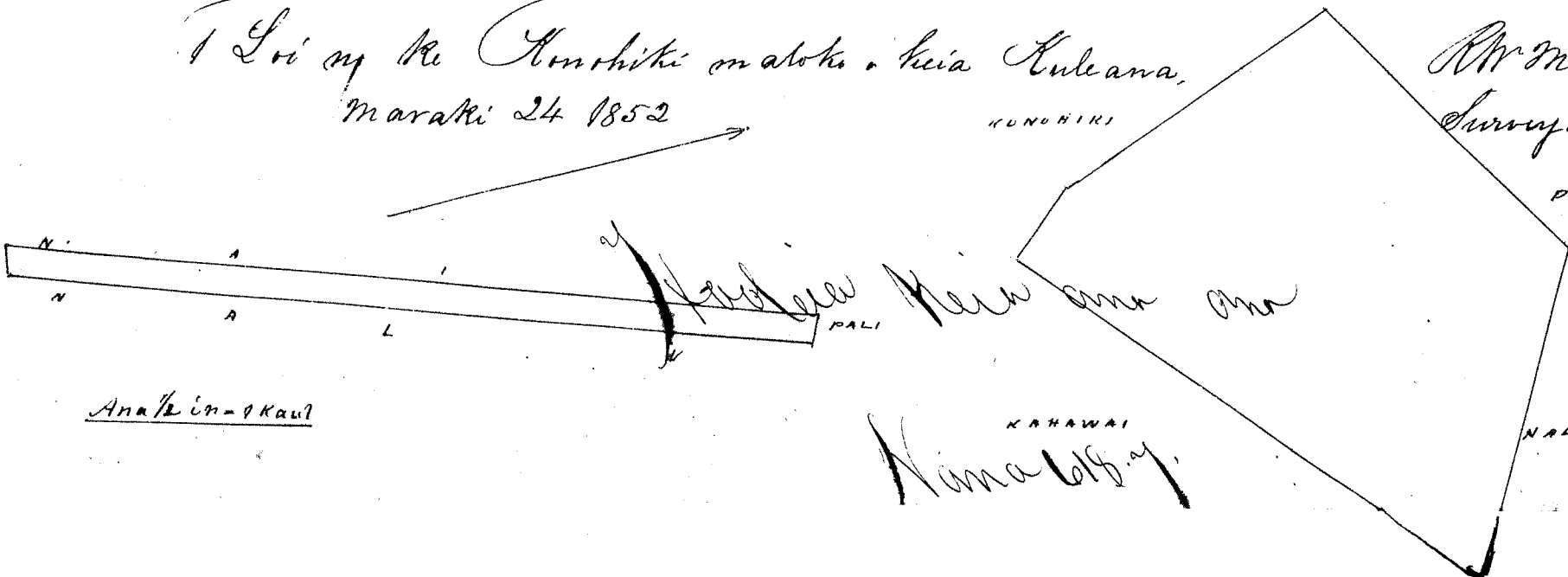

R. W. Meyer
Surveyor

Ana 1/2 in = 1 Kaul

KAHAWAI
Nana 6/18/52

W. L. Lee

J. H. Smith
G. M. Robertson
J. Kekaulaha

Honolulu July 17 1852

Hele 3963 Nao

Honouliwai Molokai

Nao Honouliwai iti Waiopitopilo Molokai

Apana 1 E hoomaka ana ma ke kahi Kikina via aina a e holo ana, Ak 57 3/4 He 4 Kaul, 72 pautu, ma ka Honoulimalo alaila, He 38 3/4 He 3 Kaul, 62 pautu, ma ka Pali alaila He 52 He 3 Kaul, 72 pautu, ma ka Pali alaila Ak 54 He 3 Kaul, 70 pautu, ma ka Pali a hiki i Kahi i hoomaka ia ma ia. Apana 1 Eka, 482 Anana,

Apana 2 E hoomaka ana ma ke kahi Komoana Komo, via aina a e holo ana, Ak 22 1/4 He 1 Kaul, ma ka Pali alaila Ak 67 3/4 He 3 Kaul, 93 pautu ma ka Pali alaila He 22 1/4 He 1 Kaul, 60 pautu ma ka Pali alaila He 67 3/4 He 3 Kaul, 93 pautu, ma ka Pali, a hiki ma Kahi i hoomaka ia ma ia Apana, 575 Anana,

Apana 3 E hoomaka ma ke kahi Akau. heia aina a e holo ana He 55 1/2 He 4 Kaul 83 pautu, ma ka Honoulimalo alaila He 34 He 2 Kaul, 60 pnt, ma ke Kauhiki alaila He 14 1/2 He 1 Kaul 60 pnt, ma ke Aupuni alaila Ak 54 1/2 He 8 Kaul, 64 pautu, ma ke Kahawai alaila Ak 9 He 4 Kaul 85 pautu, ma ke Aupuni alaila Ak 34 He 2 Kaul, 60 pautu, ma ke Aupuni a hiki i ka hoomaka ana ma ia Apana, 3 Eka 1004 Anana,

4 E 482 A
575
30004 20 pautu, ma ka Paa alaila He 70 1/2 He 1 Kaul, 62 pautu, ma ke alama alaila He 28 He 1 Kaul, 20 pnt
235
302296 ma ka Pa alaila Ak 70 1/2 He 1 Kaul, 62 pautu ma ke Kai a hiki i ka hoomaka ana, ma ia Apana
1220
58-1088 235 Anana

Maraki 25 1852

R. W. Meyer
Surveyor

Ana 1/2 in = 1 Kaul

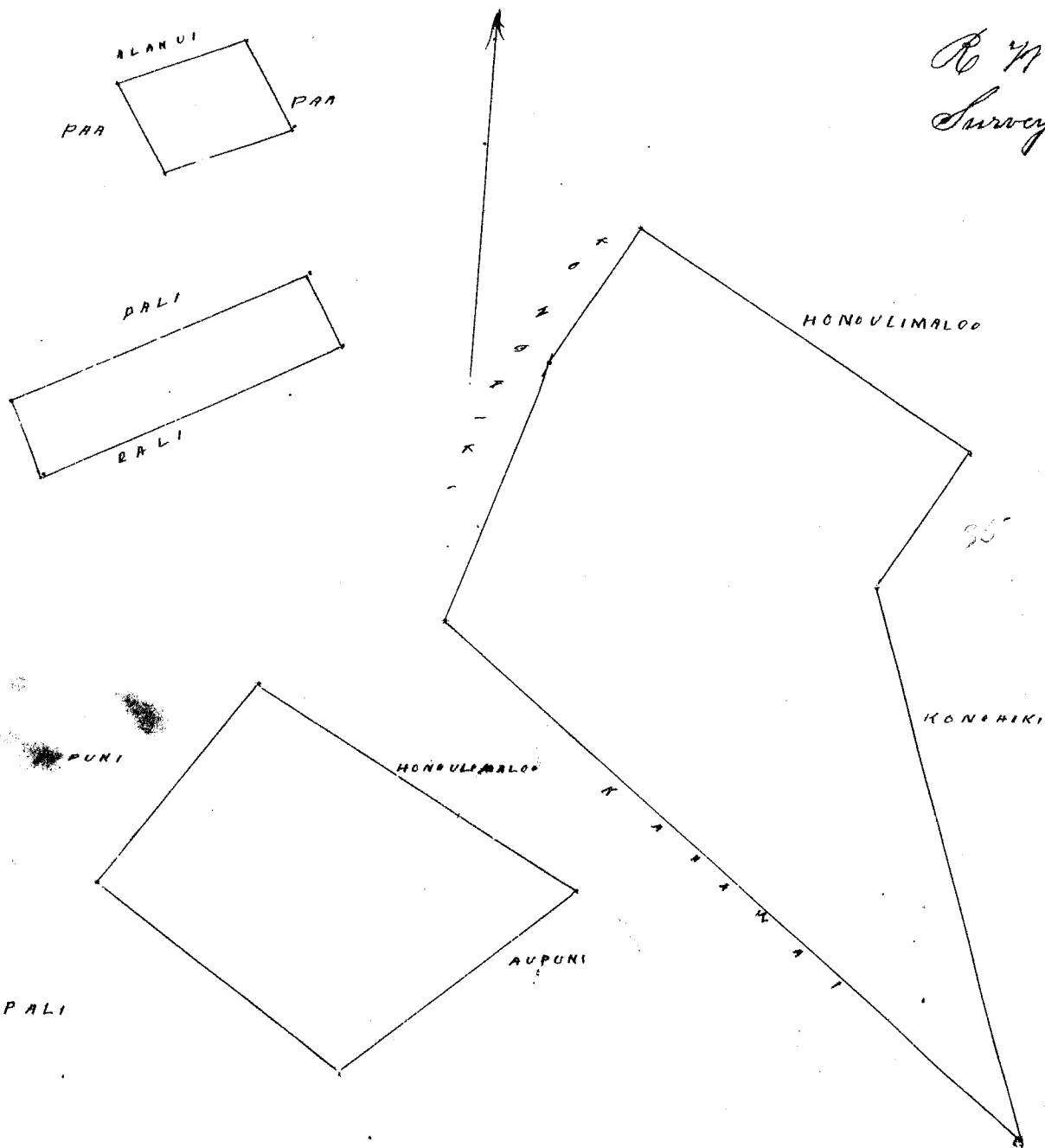

W. L. Lee
G. M. Robertson
J. H. Smith
J. Kekaulaha

Iiuli Kailiuta Ili o Kaula Molokai

Apana 1. E hoomaka ana ma ke kiki Komohana Hema o keia aina a e holo ana, Ak 24 1/4 Kom 1 Kaul, 22 pautu, ma ke Aupuni alaila Ak 43 3/4 Ii 1 Kaul, 22 pautu, ma ke alanui alaila He 44 3/4 Ii 1 Kaul, 54 pautu, ma ke Hanapila alaila Ak 65 Ii 39 pautu ma ke Hanahira alaila He 50 Ii 71 pautu, ma ke Konoiki alaila Ak 39 1/4 Ii 1 Kaul, 33 1/2 pautu ma ke Konoiki alaila He 40 1/2 Ii 81 pautu, ma ke Palu alaila He 43 1/4 Ii 1 Kaul, 25 pautu, ma ke Loko alaila Ak 46 1/4 Ii 69 pautu, ma ke Aupuni alaila He 31 3/4 Ii 97 pautu, ma ke Aupuni alaila He 87 1/2 Ii 1 Kaul, 59 pautu, ma ke Kailimeau a hiki i Kahi hoomaka ia Ma ia Apana 587 Apana

Apana 2 E hoomaka ana ma ke kiki Hema o keia aina a e holo ana, Ak 53 1/2 Ii 3 Kaul, 36 pautu ma ke Pali alaila Ak 45 Kom 5 Kaul, 90 pautu, ma ke Pali alaila Ak 63 1/4 Ii 1 Kaul, 30 pautu, ma ke Konoiki alaila He 55 Ii 5 Kaul, 62 pautu, ma ke Konoiki alaila Ak 43 1/4 Ii 98 pautu, ma ke Konoiki alaila He 42 Ii 3 Kaul, 52 pautu, ma ke Palu alaila He 49 Kom 3 Kaul, 70 pautu, ma ke Kuahua a hiki i Kahi i hoomaka ia Ma ia Apana 2 Eka, 227 Apana, Maraki 24, 1852.

R. W. Meyer Surveyor.

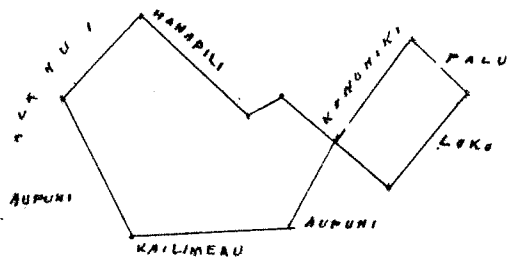
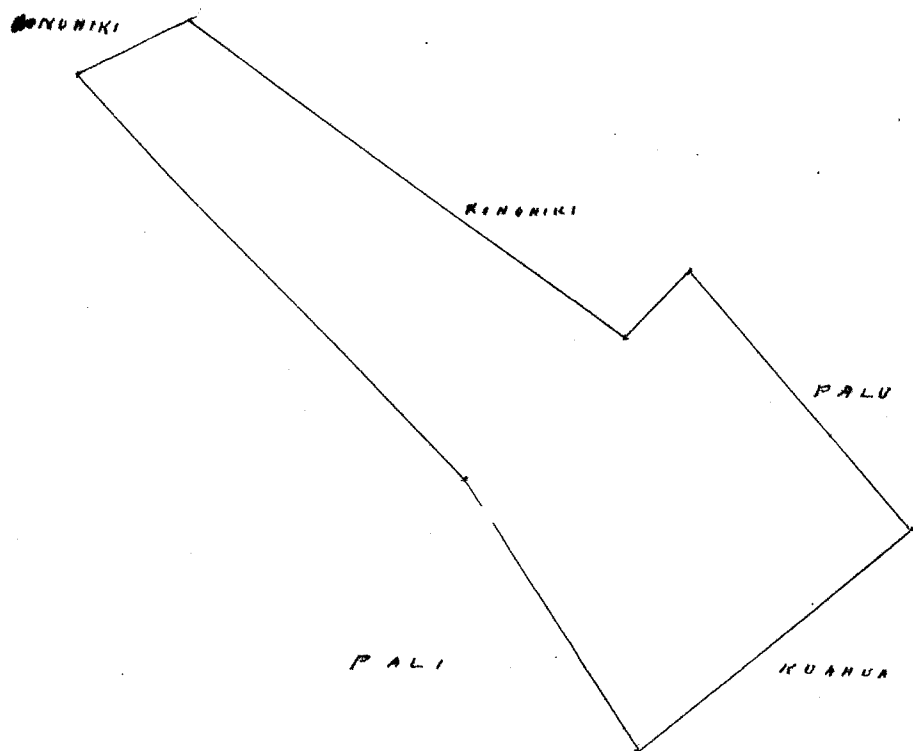

Wm Jan Lou & Co.

W. L. Lee

J. H. Smith
G. M. Robertson

J. Kekaulaheo

Honolulu Peleai 17 1852

Nakaula Honouliwai Ili o Haka Molokai

E hoomaka ana ma ke kiki Komohana Hema o keia aina a e holo ana, Ak 11 Kom 4 Kaul, 24 pautu ma ke Pali alaila He 20 Ii 5 Kaul 00 pautu, ma ke Pali alaila He 52 1/4 Kom 2 Kaul 44 pautu ma ke Loko, a hiki i Kahi i hoomaka ia Ma ia Apana 616 1/2 Apana

1 Ii ma ke Aupuni maloko, keia Kuleana

Apana 2 E hoomaka ana ma ke kiki Kikina Hema maanei, keia aina a e holo ana Ak 28 Ii 2 Kaul, 89 pautu, ma ke Pali alaila Ak 61 1/4 Ii 4 Kaul, 15 pautu ma ke Pali alaila He 43 1/2 Ii 2 Kaul, 67 pautu ma ke Pali alaila He 46 1/2 Ii 1 Kaul, 00 pautu, ma ke Pali alaila Ak 43 1/2 Ii 1 Kaul, 50 pautu ma ke Pali alaila Ak 57 1/2 Ii 40 pautu ma ke Pali alaila He 61 1/4 Ii 2 Kaul, 92 pautu, ma ke Pali alaila He 28 Ii 2 Kaul 56 pautu ma ke Pali alaila Ak 62 Ii 1 Kaul 00 pautu ma ke Pali a hiki i Kahi i hoomaka ia Ma ia Apana 1 Eka 42 Apana
Maraki 25, 1852

R. W. Meyer Surveyor

616.50
1.42
1.658.50

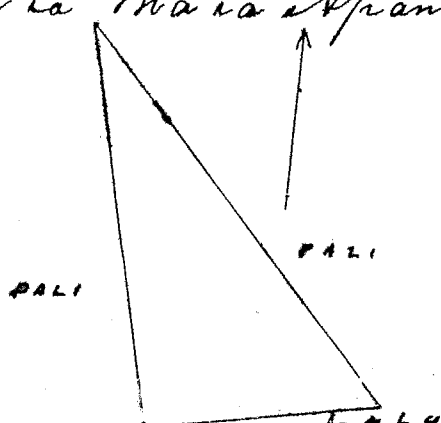
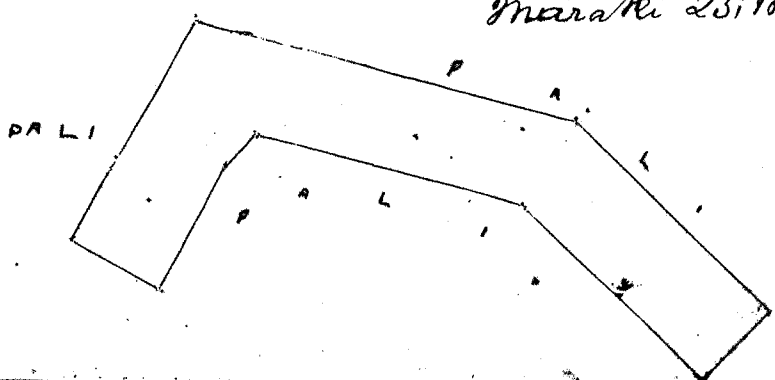

W. L. Lee
J. H. Smith
G. W. Robertson
J. Kekaulaha

Honolulu Oahu Aug 2 1852

Heleu 41713 Kolanoa + 5573

Kailiula ili

~~Kolanoa Kailiula ili. Tualalo Molokai
Apana 1 Ioi E hoomaka ana ma ke Nihii Aikina Akaia, via aina a e holo ana, He 87 1/2
pauku, ma ke Pookina alaila He 48° He 80 pauku ma ke Ioku + Aupuni alaila He 6 1/2 He
ma ke Kowohiki alaila He 26° He 59 pauku ma ke Kowohiki alaila He 83° He 45 pauku ma
Kowohiki alaila He 16 1/2 He 77 pauku ma ke Ioku alaila He 60° He 1 Haul, 4 pauku ma
Ahaimu alaila He 47 1/4 He 1 Haul 57 pauku, ma ke Ahaimu alaila He 51 1/2 He 90 pauku
ke Pookina alaila He 76 1/4 He 33 pauku ma ke Pookina alaila He 42 1/2 He 57 pauku
ke Pookina a hiki i Kahi i hoomaka ia Ma ia Apana 213 1/2 Anana~~

~~Apana 2 E hoomaka ana ma ke Nihii Akaia via aina a e holo ana, He 40 1/2 He 3
56 pauku, ma ke Ahaimu alaila He 34° He 5 Haul, 35 pauku ma ke Kowohiki alaila He
He 2 Haul 45 Pauku, ma ke Kowohiki alaila He 22 1/2 He 5 Haul 60 pauku ma ke
inu a hiki i Kahi i hoomaka ia Ma ia Apana 1 Eka 685 Anana~~

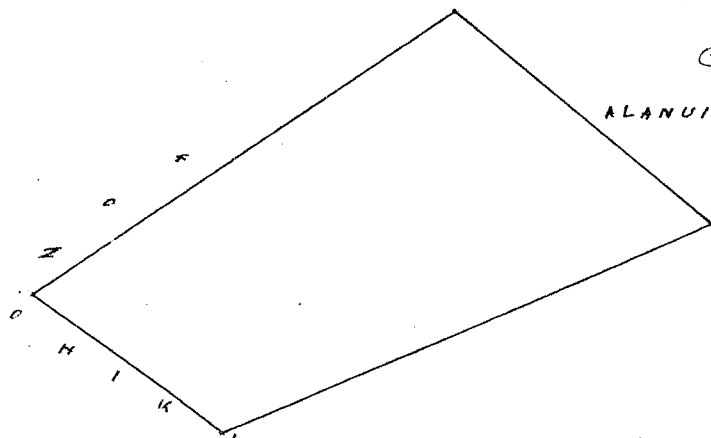
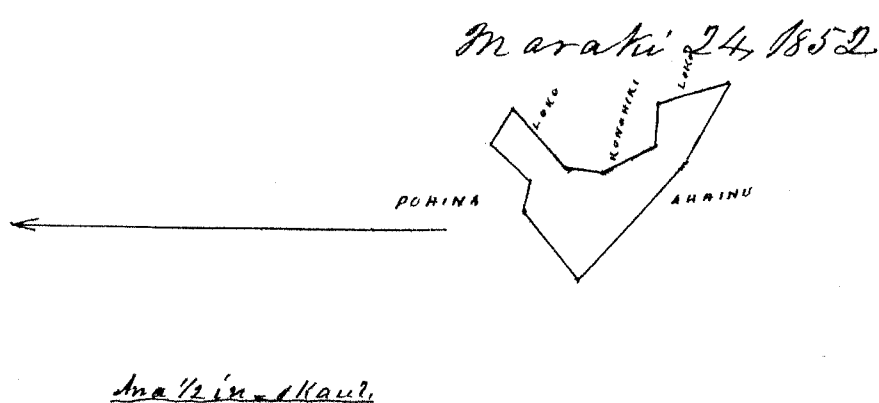

R. W. Meyer
Surveyor

See P. 295 13

W. L. Lee
J. H. Smith
G. W. Robertson
J. Kekaulaha

Honolulu Aug 2 1852

Heleu 9990 Lolo + 6027

Honouliwai Molokai

Lolo Honouliwai ili Kahi Molokai
E hoomaka ana ma ke Nihii Aikina Akaia via aina a e holo ana He 12 1/2 He 2 Haul 50 pauku
ma ke Aupuni alaila He 85° He 5 Haul, 25 pauku ma ke Pali alaila He 55° He 3 Haul 60 pauku
ma ke Pali alaila He 13 1/2 He 50 pauku, ma ke Pali alaila He 76 1/2 He 4 Haul 53 pauku
ma ke Kahawai alaila He 63° He 3 Haul, 62 pauku ma Kahawai a hiki i Kahi i hoomaka ia
Ma ia Apana 1 Eka 25 Anana,

5 Ioi ma ke Aupuni ma e holo. heia Kuluana

Maraki 25, 1852 Kooloa Keia ana ana

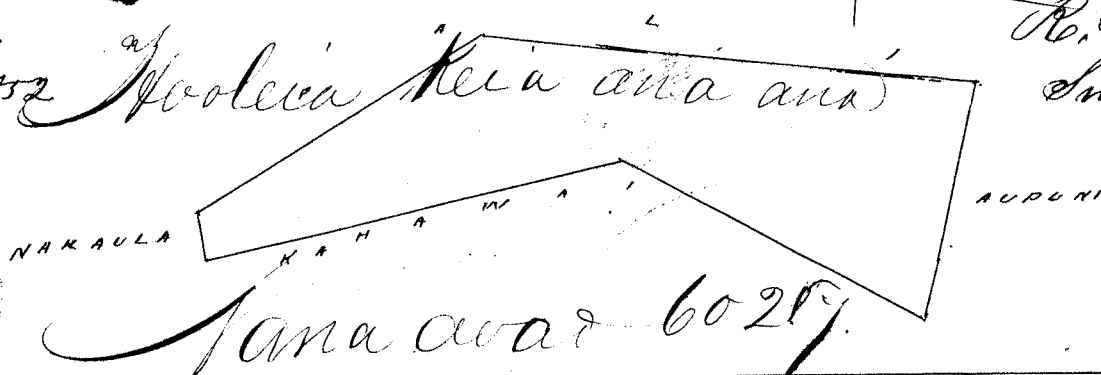

R. W. Meyer
Surveyor

W. L. Lee
G. W. Robertson
J. H. Smith
J. Kekaulaha

Honolulu Aug 2, 1852,

Helu 4733 Naa'i - 5377 Waialua Moolokai

Naa'i Waialua ili. Olahoele Moolokai

Apana 1 E hoomaka ana ma ke kahi Komohana Kema maanei oia aina a e holo ana
Ak 56 3/4 Kom 78 paunku, ma ke Komohiki alaila Ak 44 1/4 Hi 8 Kaul, 28 paunku ma ke Kahu
kahukai, alaila He 39 Hi 34 paunku ma ke pali alaila He 41 1/4 Kom 8 Kaul 00 ptk
ma ke Pomane, a hiki i kahi i hoomaka ia Ma ia Apana 493 Anana;

Apana 2 E hoomaka ana ma ke kahi Komohana oia aina a e holo ana Ak 54 Hi 5 Ak
48 paunku ma ke Kahuina alaila He 50 1/2 Hi 1 Kaul, 58 paunku ma ke Pali alaila He 30 1/2
Kom 5 Kaul 20 paunku, ma ke Kanakale, alaila He 45 1/2 Kom 78 paunku ma ke
Kanakale, alaila Ak 42 Kom 3 Kaul, 70 paunku ma ke Kahawai a hiki i kahi i hoom-
aka ia Ma ia Apana 1 Eka 21 1/2 Anana,

2 Ioi Kalo maloko o keia Kuleana,
Maraki 24 1852

C. W. Meyer
Surveyor

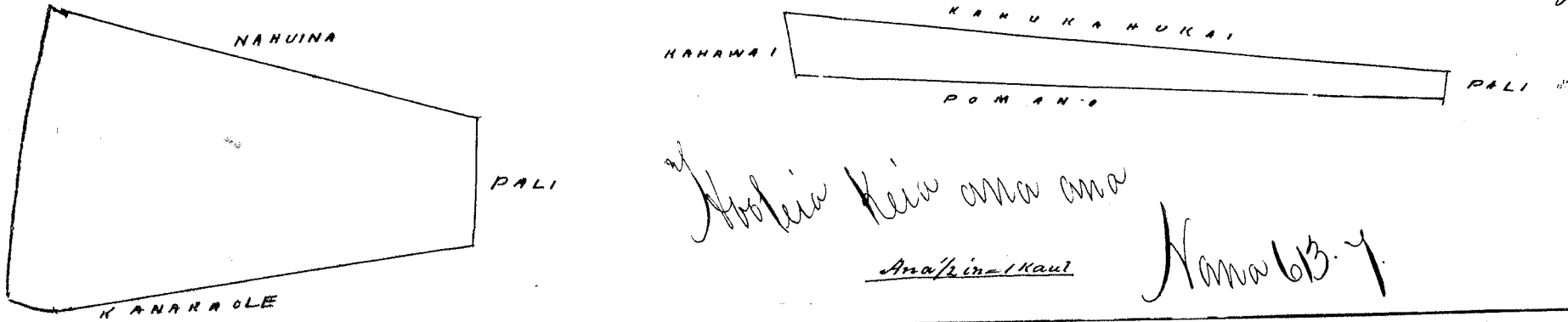

Uku Pau Loa # 5

W. L. Lee

J. H. Smith
G. M. Robertson
I. Hekaulahao

Honolulu Aug 2 1852

Helu 6691 Lili + 6377 Waialua Moolokai

Lili Waialua ili. Kaula Moolokai

Apana 1 E hoomaka ana ma ke kahi Komohana Kema maanei oia aina a e holo ana
Ak 46 3/4 Kom 1 Kaul 10 1/2 paunku ma ke Kahawai alaila Ak 44 Hi 2 Kaul, 20 paunku
ma ke Kanana, alaila He 36 1/2 Hi 1 Kaul, 18 paunku ma ke pali alaila He 44 3/4
Hi 8 Kaul 95 paunku, ma ke Mahuka a hiki i kahi i hoomaka ia 2 Ioi ma ke Kona-
hiki maloko o keia Kuleana Ma ia Apana 1 Eka, 21 Anana,

Apana 2 E hoomaka ana ma ke kahi Kema o keia Aina a e holo ana Ak 16 Kom 1 Kaul
57 paunku ma ke Kahawai alaila Ak 7 1/2 Kom 1 Kaul 70 paunku ma ke Kahawai alaila
He 76 3/4 Hi 69 paunku ma ke Komohiki alaila He 9 1/4 Hi 2 Kaul 95 paunku ma ke pali
alaila He 80 3/4 Kom 45 paunku ma ke Komohiki a hiki i kahi i hoomaka ia Ma ia
Apana 249 Anana,

Maraki 24, 1852,

C. W. Meyer
Surveyor

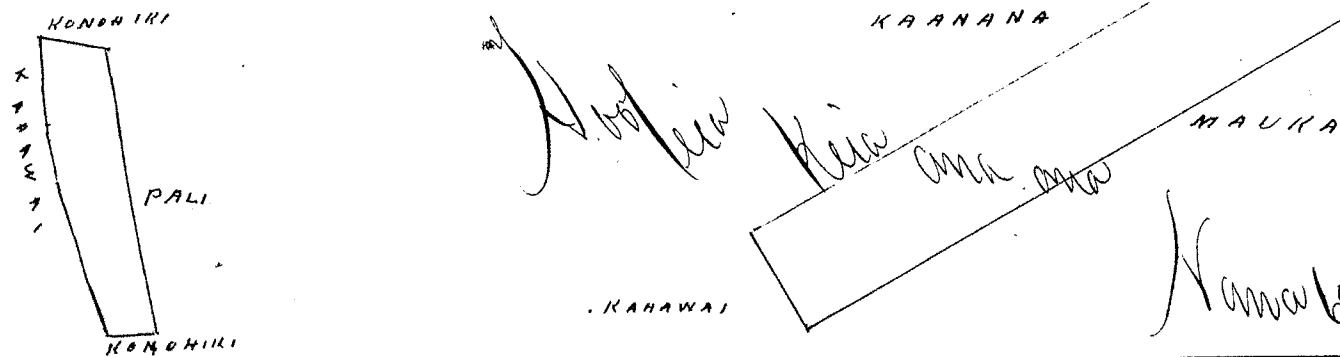

Uku Pau Loa # 5

W. L. Lee

G. M. Robertson

Honolulu Aug. 2, 1852.

J. H. Smith
I. Hekaulahao

Paakai Kamanoni Molokai
 I hoomaka ana ma ke kiki Aihina Akaun owaika via aina a e holo ana, He $41\frac{1}{2}$ Kom
 40 pautu ma ka pa, ataita He $16\frac{1}{2}$ Hei 1 Kaul $43\frac{1}{2}$ pautu ma ke Konohiki alaila He $11\frac{1}{2}$
 pautu ma ke Konohiki alaila He 33 Hei 2 Kaul, $71\frac{1}{2}$ pautu, ma ke Konohiki alaila He
 Kaul, $36\frac{1}{2}$ pautu ma ke Konohiki alaila He 24 Hei 2 Kaul 21 pautu ma ke Konohiki alaila
 Hei 2 Kaul 40 pautu, ma ke Konohiki alaila He $55\frac{1}{4}$ Kom 2 Kaul, $66\frac{1}{2}$ pautu ma ke Kawan
 a hiki i kahi i hoomaka ia ma ia Apana 346 $\frac{1}{2}$ Ika,

Maraki 24 1852

Aoleia no keia ana ana

Kona aoo 629.7

Ana 1/2 in = 1 Kaul

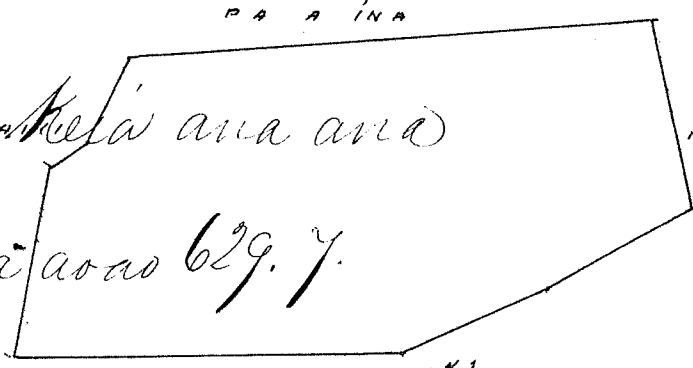

R. W. Meyer
Surveyor

Wku Pau Loa # 6.

W. L. Lee

J. H. Smith
G. M. Robertson

J. Kekaulaao

Honolulu Aug 2 1852

Heleu 4613 Palapala

Honouliwai Molokai

Palapala Honouliwai Iki. Kalamo Molokai

Apana 1 I hoomaka ana ma ke kiki Aema via aina a e holo ana, He $21\frac{1}{4}$ Hei 5 Kaul 15 pautu
 ma ke Kahawai alaila He $41\frac{1}{2}$ Hei 4 Kaul 62 pautu ma ka pali alaila He $75\frac{3}{4}$ Hei 1 Kaul 20
 pautu ma ka Pali alaila He 25 Kom 55 pautu ma ke Kawa alaila He 76 Kom 2 Kaul 68 pautu
 ma ke Kahawai a hiki i kahi i hoomaka ia I Ioi ma ke Aupuni on aloha, keia Auleana
 ma ia Apana, 68 Apana,

Apana 2 I hoomaka ana ma ke kiki Komohana Aema via Aina a e holo ana He 12
 Kom 1 Kaul 63 pautu, ma ka Pali Kula alaila He 70 Hei 1 Kaul 81 pautu ma ka pali alaila
 He 12 Hei 1 Kaul 63 pautu, ma ka pali He 70 Kom 1 Kaul 81 pautu ma ke alama a hiki i
 kahi i hoomaka ia Ma ia Apana 350 Apana,

Maraki 25, 1852

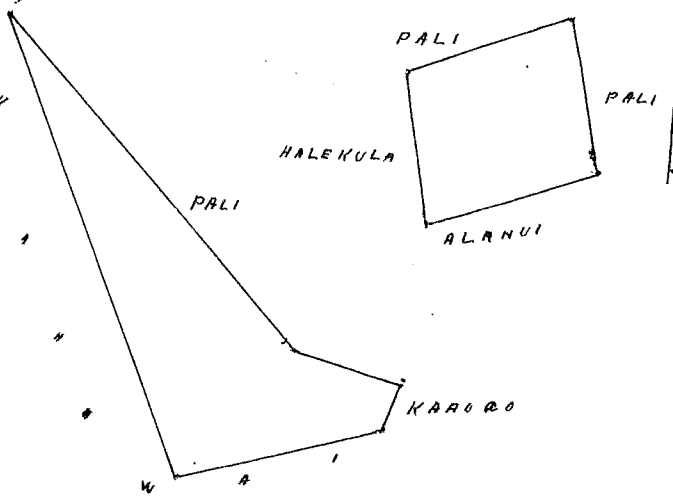

Ana 1/2 in = 1 Kaul

R. W. Meyer
Surveyor

Wku Pau Loa # 4.

W. L. Lee

G. M. Robertson
J. H. Smith

J. Kekaulaao

Honolulu Aug 2 1852

Maku Honoione ili Kulalamiti Molokai

E hoomaka ana oia ke Pihiki Aihina kema o keia Lii a i holo ana ke 36 1/4° Ke 10 Kaul 24 pautu
 ana ke Keoni alaila ke 57° Ke 96 pautu ana ke Ke Loko alaila ke 22 1/2° Ke 1 Kaul 14 pautu
 ana ke Ke Loko, alaila ke 44 1/4° Ke 1 Kaul 77 pautu ana ke Ke Honohiki alaila ke 16 3/4° Ke 45
 pautu, ana ke Ke Pilaliohe, alaila ke 43 1/2° Ke 42 pautu ana ke Ke Pilaliohe alaila ke 54 3/4°
 Ke 1 Kaul 16 1/2 pautu, ana ke Ke Pilaliohe alaila ke 34° Ke 1 Kaul 28 pautu ana ke Keoni
 alaila ke 23 1/2° Ke 31 pautu ana ke Keoni alaila ke 54 1/2° Ke 1 Kaul 54 pautu ana ke
 Keoni a hiki i ka hoomaka ana, Ma ia Apana 795 Anana,
 Maraki 24, 1852,

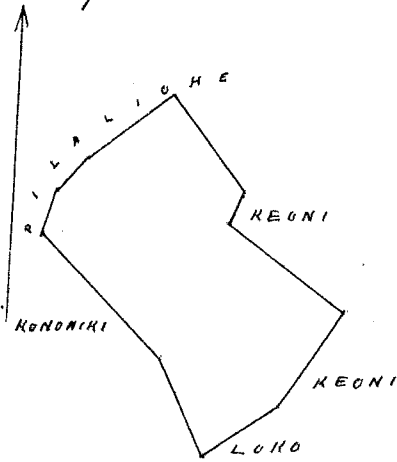

J. W. Meyer
Surveyor

Ana 1/2 in = 1 Kaul

Wm Pan Lra # 4.

W. L. Lee

J. H. Smith
G. M. Robertson
J. Kikaulakao

Honolulu Aug 2 1852

Polu 6652 Lima

Waialua Molokai

Lima

E hoomaka ana oia ke Pihiki Aihina Akau, ana keia ia a i holo ana, ke 51 3/4° Ke 3 Kaul
 87 pautu ana ke Ke Honohiki alaila ke 41 3/4° Ke 1 Kaul 65 pautu ana ke Ke Kaili alaila ke 52 1/4°
 Ke 3 Kaul 82 pautu, ana ke Ke Kaili alaila ke 44° Ke 1 Kaul 12 pautu ana ke Ke Kahawai a
 hiki i Keahi i hoomaka ia Ma ia Apana 501 Anana,
 Maraki 23 1852,

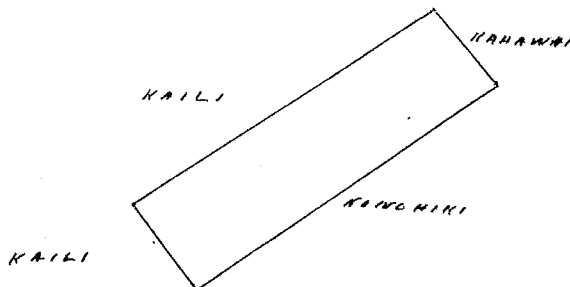

J. W. Meyer
Surveyor

Ana 1/2 in = 1 Kaul

Wm Pan Lra # 4

W. L. Lee

J. H. Smith
G. M. Robertson
J. Kikaulakao

Honolulu Aug 2 1852

Polu 8654 Kapaele

Waialua Kula Maui

8654 Kapaele ana Waialua Kula Maui

Apana 1 Kula ana Moanui & Pakaka E hoomaka ana oia ke Pihiki Aihina Akau a i holo ana ke 6° Ke 350 pautu a pili ana i ke alanui ke 65° Ke 1300 pautu a pili ana i ke alanui
 ke 280 pautu a pili ana oia ke Ke Honohiki ke 40° Ke 1255 pautu a pili ana oia ke Ke Honohiki
 i ke Pihiki ana 3 2/5 Eka,

Apana 2 Kula ana Kailiki

E hoomaka ana oia ke Pihiki Honohana Akau, a i holo ana ke 85° Ke 555 pautu a pili ana
 i Ke Ke Honohiki ke 2 Ke 385 pautu ana ke Ke Honohiki Keomaha Ke pautu a pili ana
 ana ke Ke Honohiki ke 4 Ke 300 pautu a pili ana ana ke Ke Alanui i Ke Alanui ana Eka

3.90
5.20
7.50
16.60

Apana 3 Kula ma Kaliki E hoomaka ana ma ke kahi Aha, a e holo ana he 5 He 530 panta e pili ana i ke Naha, He 88 He 14,00 panta e pili ana me ke Konoiki Ake 9, He 235 panta e pili ana i ke Konoiki Ake 77 He 935 panta e pili ana me ke Kealahou, Ake 74 He 495 panta e pili ana me ke Kealahou i ke kahi mua, 5 1/5 Eka,

Apana 4 Kula ma Kaliki E hoomaka ana ma ke kahi Aha, a e holo ana, He 60 He 1520 panta e pili ana me ke Naha & Konoiki He 31 He 1006, e pili ana me ke Konoiki Ake 40 He 440 e pili ana me ke ke Konoiki Ake 16 He 1285 panta e pili ana me Aha & Konoiki i ke kahi mua 7 1/2 Eka

Kula 22 Jan 1852

A. F. Turner
Luna ana aina

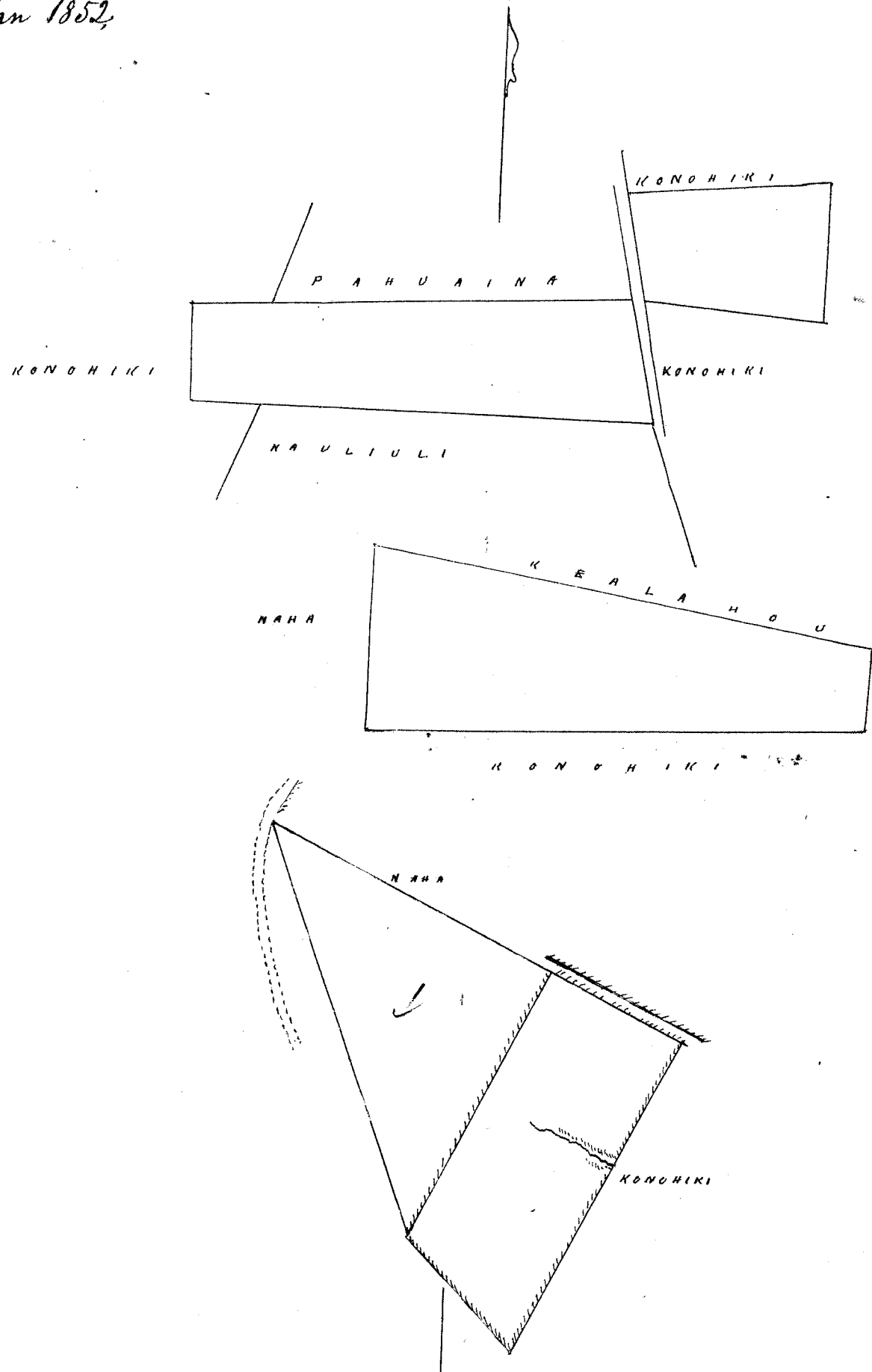

Wm. Pau Lea # 12

M. L. Lee

G. M. Robertson

D. H. Smith

J. Kaulahao

Honolulu Aug 5 1852

Hele 8550 Kouaihulu

Kaialaimui Kula Mani

8550 Kouaihulu ma Kaialaimui

Apana 1 Kula ma Kauhahouwai E hoomaka ana ma ke kahi Aha, a e holo ana, Ake 74 He 1248 panta e pili ana i ke Konoiki Ake 25 He 775 panta e pili ana i ke ke Konoiki Ake 57 He 1338 panta e pili ana me ke Konoiki Ake 35 He 578 panta e pili ana me ke Piliwai i ke kahi mua, 8 2/5 Eka,

Apana 2, Kula liliu ma "Kealakaie" E hoomaka ana ma ke kahi Aha, a e holo ana He 11 He 695 panta e pili ana i ke ke Konoiki aina, He 80 He 1665 panta e pili i ke ke Konoiki aina Ake 25 He 375 panta, e pili ana me ke ke Konoiki aina Ake 15 He 935 panta e pili ana me ke Kahohouapa, Ake 6 1/2 He 860 panta e pili ana me ke Kahohouapa i ke kahi mua 8 1/4 Eka

Kula Mani
26 Jan 1852

A. F. Turner
Luna ana aina

Wm Pau Loa #15

W. L. Lee
G. M. Robertson
J. H. Smith

Honolulu Aug 5 1852

8462 Kawaalau

Waiakoa Kula Maui

8462 Kawaalau ma Waiakoa Kula Maui

Apana 1 Kula ma Kalihī E hoomaka ana ma ke kīhi Aema, a e holo ana, AK 9° Hi 460 pautu e pili ana i ke Aema, AK 79° Hi 850 pautu e pili ana, me ke ke Konoehiki, AK 22° Hi 280 pautu e pili ana me ke Kahoopaki, AK 67 1/2° Hi 929 pautu e pili ana me ke Nāuliuli i ke kīhi mua, 3 1/5 Eka,

Apana 2, Kula ma Kalihī E hoomaka ma ke kīhi Aikina Aka a e holo, AK 67 1/2° Hi 190 pautu e pili ana i ke Nāuliuli AK 74° Hi 700 pautu e pili ana me ke Kahoopaki AK 25° Hi 344 pautu e pili ana me ke Kahoopaki, AK 61° Hi 880 pautu ma ke ke Konoehiki AK 23 1/2° Hi 545 pautu ma ke Kaha a i ke kīhi mua, 3 8/10 Eka,

Apana 3, Kula ma Kalihī E hoomaka ana ma ke kīhi Aka, a e holo ana, AK 62 1/2° Hi 751 pautu e pili ana i ke Manale, AK 20° Hi 540 pautu e pili ana me ke Nāuliuli AK 61° Hi 680 pautu e pili ana me ke ke Konoehiki AK 12° Hi 545 pautu e pili ana me ke Aema i ke kīhi mua, 4 1/2 Eka

Apana 4 Kula ma Moonei E hoomaka ana ma ke kīhi Aema, a e holo ana, AK 71° Hi 380 pautu e pili ana i ke ke Konoehiki AK 18° Hi 320 pautu e pili ana i ke Napela Aikina 310 pautu ma ke Konoehiki AK 7° Hi 425 pautu e pili ana me ke Konoehiki i ke kīhi mua, 1 1/4 Eka

28 Jan 1852

A. F. Turner
Luna ana aia

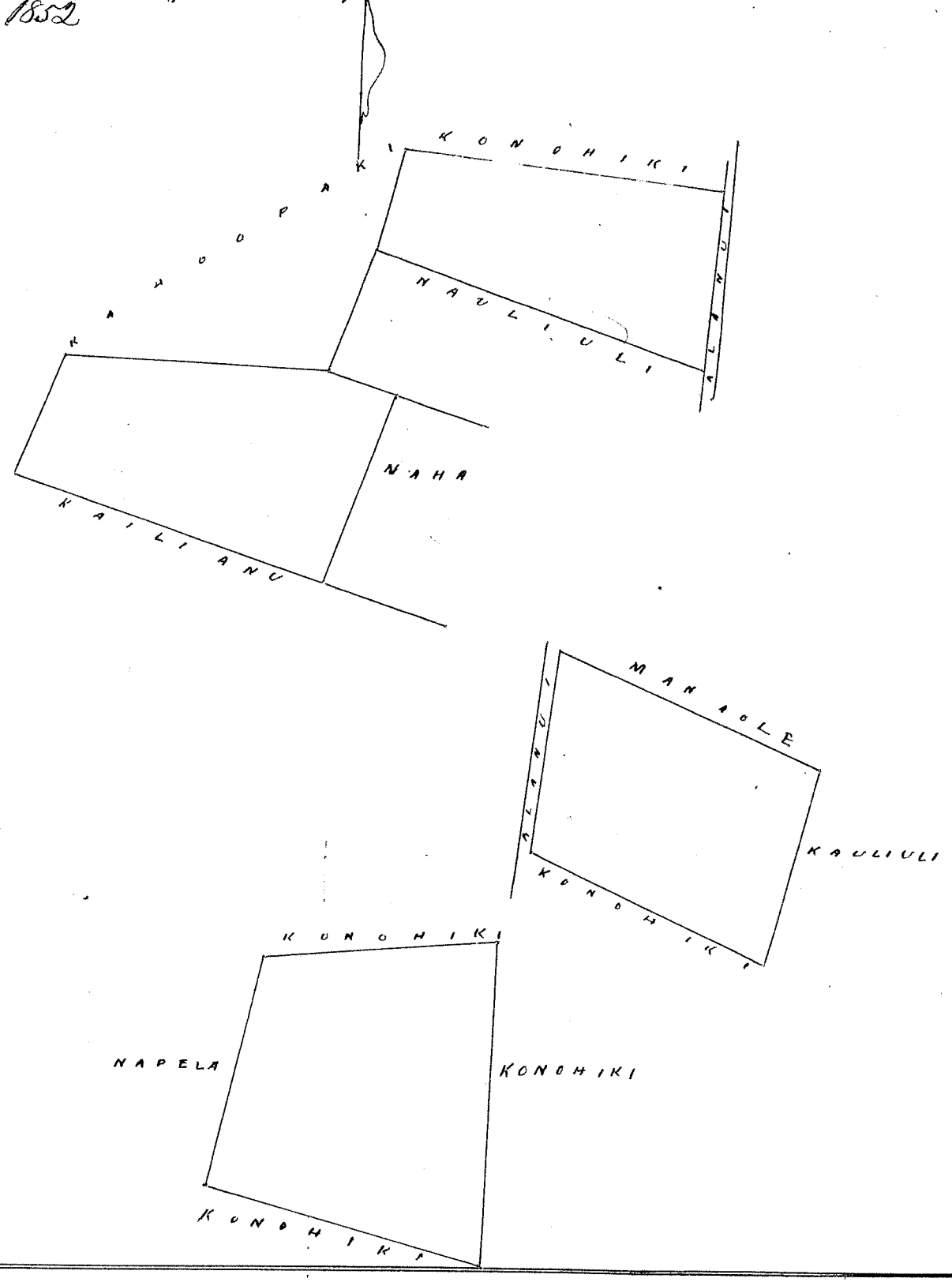

Wm Pau Loa #10
W. L. Lee
G. M. Robertson
J. H. Smith

Honolulu 5 Aug 1852

Vol 5465 MAKAHANI

Kailua Honolulu Kula Maui

5465 Makahani, ma Kailua Honolulu, Kula Maui

Apana 1 Kula ma Kailua Chomaka ana ma ke kahi hihina Akau, a e holo ana, He 13° He 600 pautu e pili ana i ke Koi He 72° He 458 pautu e pili ana i ka pali o Koho He 76° He 290 pautu ma ka pali o Koho, He 13° He 274 pautu e pili ana me ke Konoiki He 25° He 450 pautu e pili ana i ke Konoiki He 510 pautu e pili ana me ke Konoiki i ke kahi mua 4 1/2 Eka,

Apana 2 Kula ma Kailua Chomaka ana ma ke kahi Konoihana Akau, a e holo ana, He 70° He 1010 pautu e pili ana i ke Konoiki He 32° He 400 pautu e pili ana me ke Konoiki He 70° He 330 pautu e pili ana me ka pali o Koho Konoihana 500 pautu e pili ana me ka pali o Koho He 9 1/2 He 600 pautu e pili ana me ke Koi, i ke kahi mua, 4 1/100 Eka,

Apana 3, Kula ma Kailua Wala lili Chomaka ana ma ke kahi Ak, a e holo ana He 63° He 600 pautu e pili ana i ke ke Konoiki He 15° He 290 pautu e pili ana i ke ke Konoiki He 63° He 620 pautu e pili ana me ke ke Konoiki He 20° He 285 pautu e pili ana me ke ke Konoiki i ke kahi mua 1 6/10 Eka

Kula Maui
26 Jan 1852

A F Turner
Luna ana aina

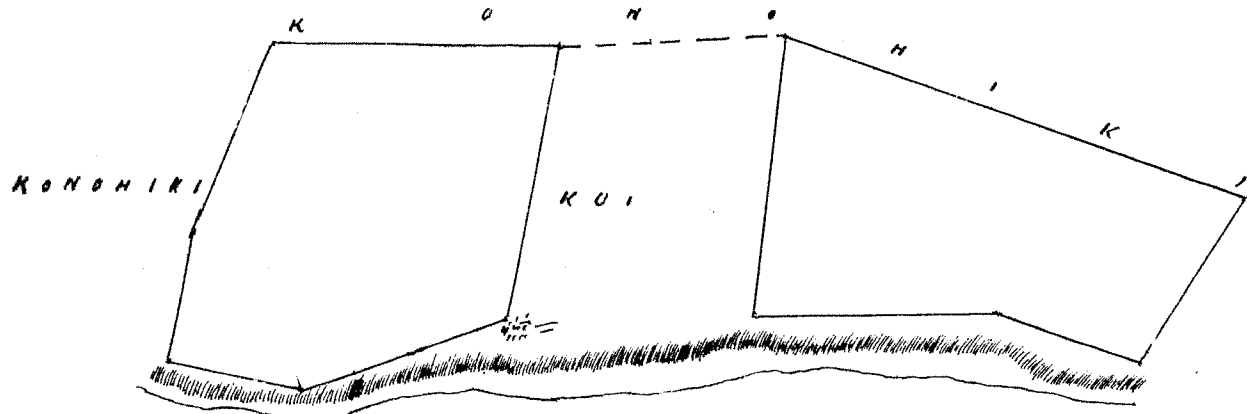

4.50
4.15
1.60
10.25

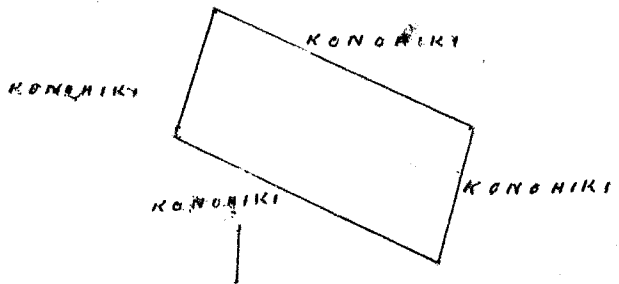

Wm Pau Loa # 9
W. L. Lee
G. M. Robertson
O. H. Smith

Honolulu 5 Aug 1852

A. Kekaulahau

Vol 5299 Kalia

Konaulu Kula Maui

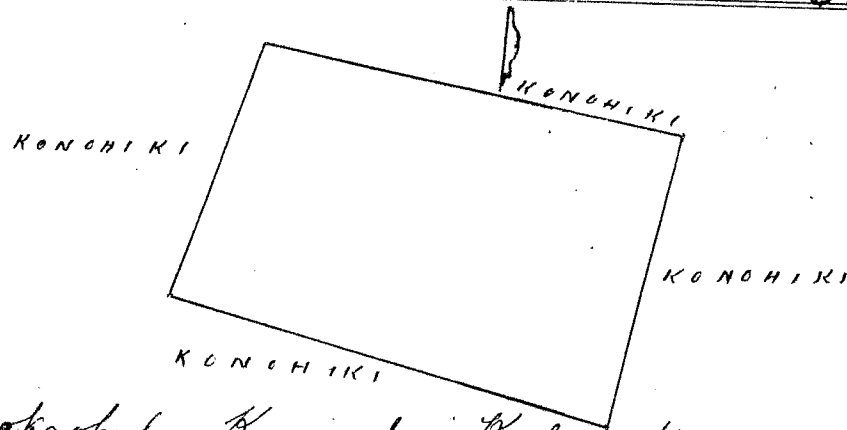

Kalia ma Punaohulu, Konaulu Kula Maui
Kula Chomaka ana ma ke kahi hihina a e holo ana, He 73° He 480 pautu e pili ana i ke ke Konoiki He 22° He 285 pautu e pili ana i ke ke Konoiki He 77 1/2 He 450 pautu e pili ana i ke ke Konoiki He 15° He 310 pautu e pili ana i ke ke Konoiki i ke kahi mua 1 4/10 Eka

26 Jan 1852

A F Turner
Luna ana aina

Palikai, ma Keoheka Kula Maui.

Apana 1 Kula ma Wailuku E hoemaka ana ma ke Kihia Akau a e holo ana He 25' Ho 300 pautu e pili ana, i ke Uilani He 71' Ho 460 pautu e pili ana i ke Maiole He 25' Ho 270 pautu e pili ana i ke Halekahi, He 2 1/2' Ho 470 pautu ma ke Kairiwalii i ke Kihia mua 1 3/4' Eka

Apana 2, Kula ma Wailuku E hoemaka ana ma ke Kihia Akau a e holo ana He 25' Ho 213 pautu e pili ana, i ke Halekahi, He 71' Ho 620 pautu e pili ana me ke Maiole He 24 1/2' Ho 240 pautu e pili ana me ke Alanui, He 7 3/2' Ho 637 pautu e pili ana me Kairiwalii i ke Kihia mua 1 7/8' Eka

Apana 3, Pahala ma Kalipolipo E hoemaka ana ma ke Kihia Akau a e holo ana He 5 1/2' Ho 79 pautu e pili ana i ke Mahiai He 85' Ho 95 pautu e pili ana i ke Lake He 5' Ho 85 pautu e pili ana, me ke Konoheki He 89' Ho 94 pautu e pili ana me ke Konoheki i ke Kihia mua 8/100 Eka

Apana 4 Kula ma Paliku Keoheka, E hoemaka ana ma ke Kihia Akau a e holo ana He 36' Ho 812 pautu e pili ana i ke Kauhia He 72' Ho 1550 pautu e pili ana me ke Konoheki He 20' Ho 730 pautu e pili ana me ke Konoheki He 78' Ho 1329 pautu e pili ana me ke Konoheki i ke Kihia mua 10 4/10 Eka

Apana 5, Kula ma Ahulua Waiohuli E hoemaka ana ma ke Kihia Akau a e holo ana He 18 1/2' Ho 450 pautu e pili ana i ke ke Konoheki He 76' Ho 465 pautu e pili ana i ke Maas He 20' Ho 330 pautu e pili ana i ke ke Konoheki He 62' Ho 500 pautu e pili ana i ke Keoheka, i ke Kihia mua, 18 6/100 Eka

10 Feb'y 1852.

A. Turner
Luna ana amas

127
10.50
1.50
10.50

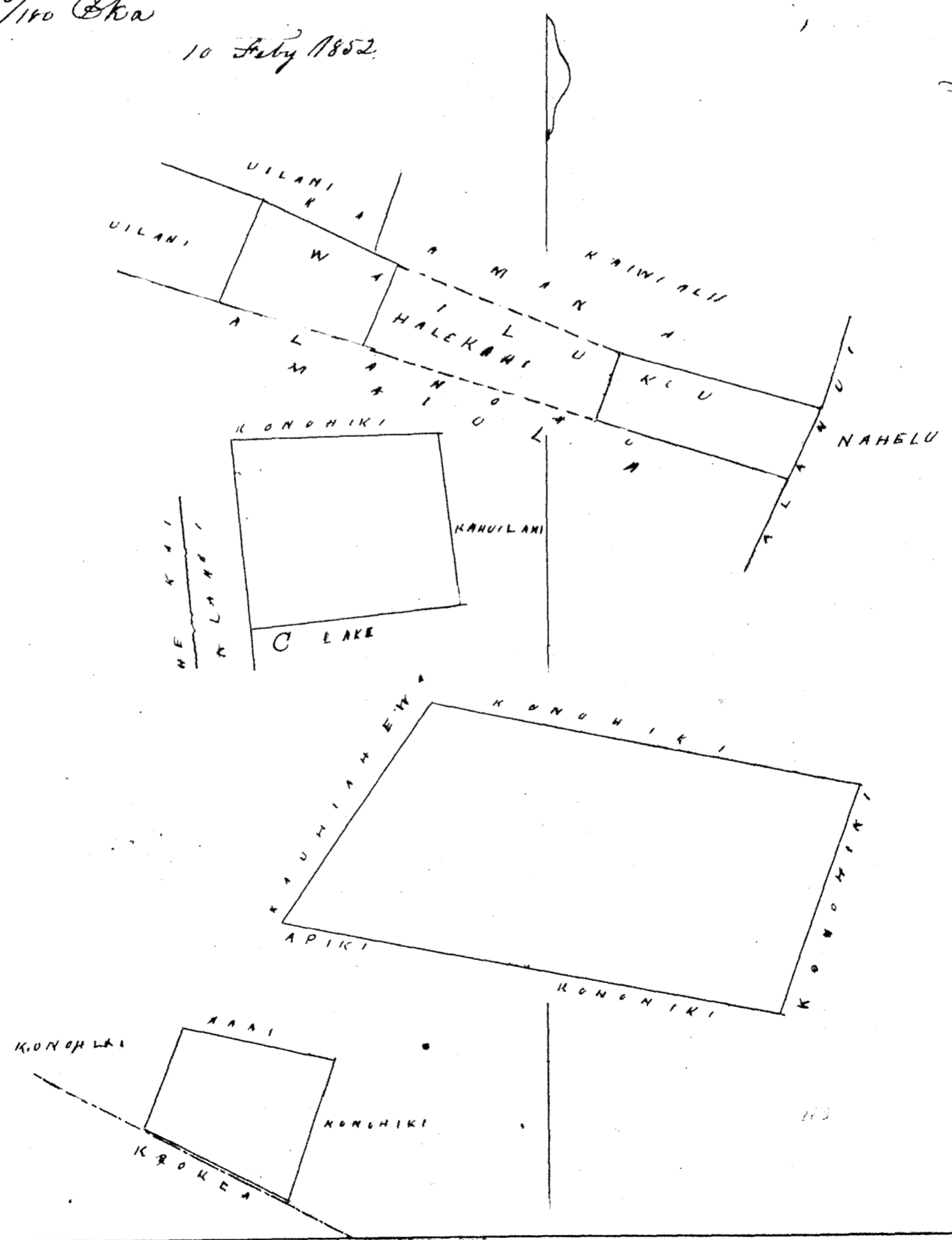

Wm Pau Loa # 12
W. L. Lee
G. M. Robertson
S. H. Smith
J. Kihaukaha

Honolulu 5 Aug 1852

Kaiaialii ma Hekeia Kula Maui

Apana 1. Kula ma Wailuku E hoomaka ma ke Pihia Aema a e holo ana, Ak 55 No 240 pautu e pili ana me ke Kuaana Ak 28 No 335 pautu e pili ana i ke ala Ak 62 No 245 pautu e pili ana me Honohiki Ak 30 No 360 pautu e pili ana me ke Honohiki i ke kahi mua 82/100 Eka

Apana 2 Kula ma Ahulua Waiokuli E hoomaka ana ma ke Pihia Akau a e holo ana Ak 23 No 215 pautu e pili ana i ke ke Honohiki Ak 62 No 480 pautu e pili ana me Hekeia Ak 33 1/2 No 220 pautu e pili ana me Hekeia, Ak 64 No 520 pautu e pili ana me ke Ala i ke Pihia mua, 1/10 Eka,

Apana 3, Kula ma Kaamana Hekeia, E hoomaka ana ma ke Pihia Akau, a e holo ana Ak 67 No 1450 pautu e pili ana i ke Waiokuli Ak 475 pautu e pili ana i ke alanui, Ak 73 1/2 No 637 pautu e pili ana me Palikai Ak 67 No 737 pautu e pili ana me ke Halekahi, Ak 62 1/2 No 83 pautu e pili ana me ke Palikai Ak 18 1/2 No 540 pautu e pili ana me Palikai, i ke kahi mua 7 28/100 Eka

9 Feby 1852,

A. F. Turner
Lama ana sine

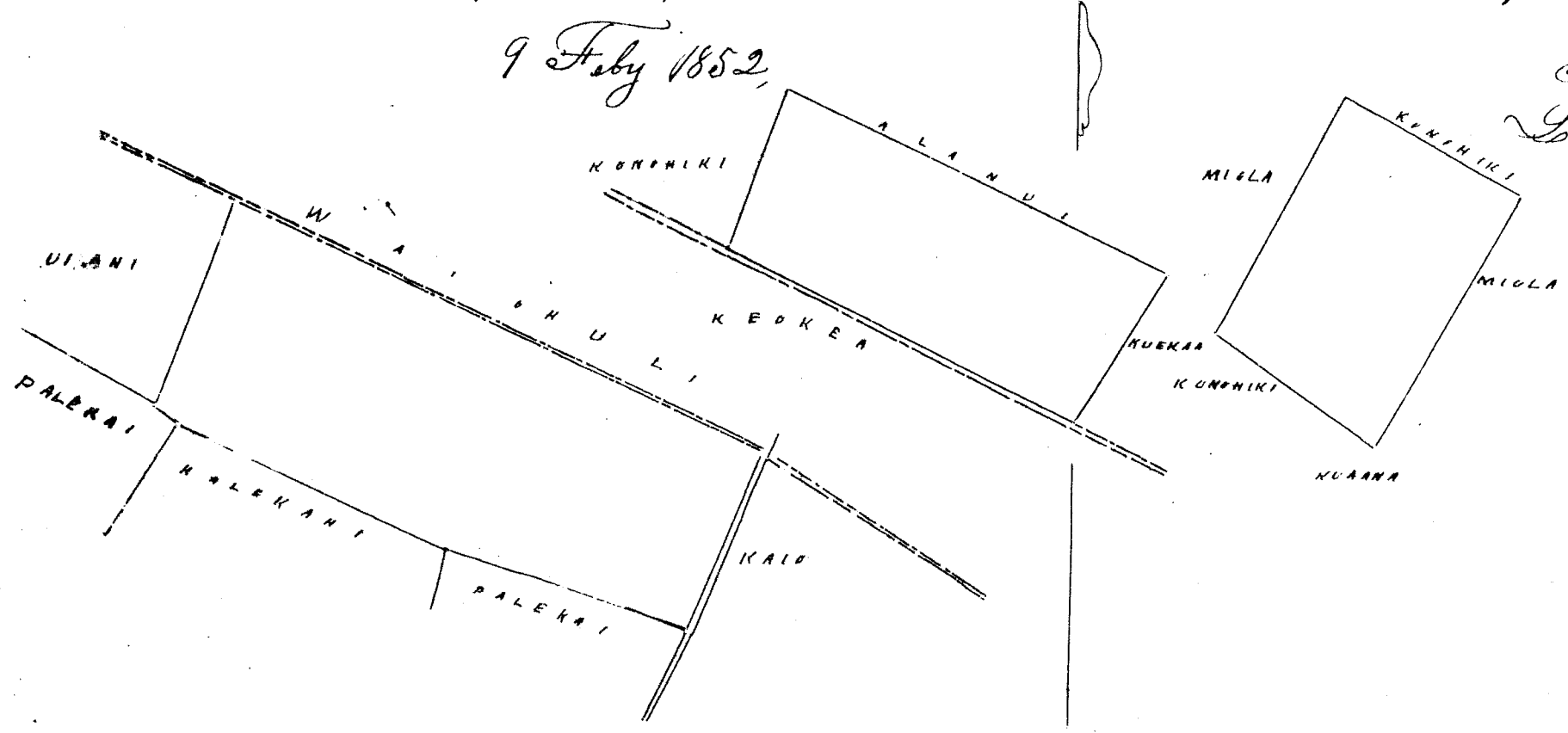

Wm. Pau Lea & S.
W. L. Lee
G. M. Robertson
J. H. Smith

Honolulu 5 Aug 1852 J. Kekaulaha

Kele 7021 Kaamau Koonoulu Kula Maui

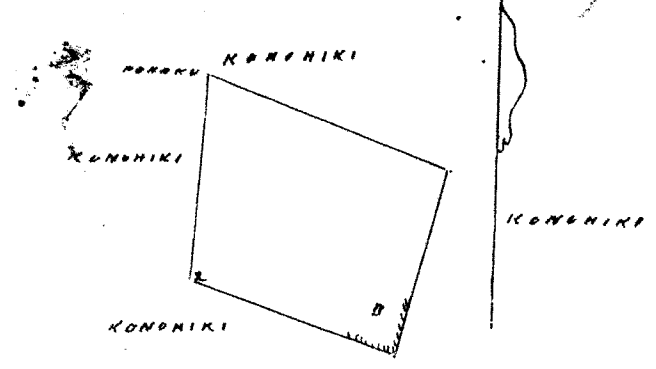

See page 706 Vol. 7. Part 2.

534E
50
600

Kaamau ma Kapikahawai Koonoulu Kula Maui

Pakala & Kula, E hoomaka ana ma ke Pihia Aema, a e holo ana Ak 76 No 225 pautu e pili ana i ke ke Honohiki Ak 2 No 220 pautu e pili ana i ke Honohiki Ak 71 No 270 pautu e pili ana me ke Honohiki Ak 14 No 205 pautu e pili ana me ke Honohiki i ke Pihia mua, 1/2 Eka,

28 Jan 1852

A. F. Turner
Lama ana sine

Wm. Pau Lea & S.
W. L. Lee
G. M. Robertson
J. H. Smith
J. Kekaulaha

Honolulu 5 Aug 1852

G. M. Robertson

J. H. Smith

J. Kekaulaha

Honolulu 5 Aug 1852

Keolu 8866 Kaniho

Kaniho ma Pulehu, Kula, Maui.

Apana 1 Kula ma Kukuinaeana, E hoomaka ana ma Ke Kihiki Kihiki, a e holo ana Ak, 80 1/2, Hi, 374, paauku, e pili ana i ke Wahine, Ak, 6 1/2, Hi, 427, paauku e pili ana i ke Wahine, Ak, 19 3/4, paauku e pili ana, me ke Konoiki, Ak, 58, Hi, 185, paauku e pili ana me ke Wahine, Ak, 4 1/2, Hi, 880 paauku ma ke Konoiki, i ke Kihiki mua, 4, Eka,

Apana 2, Kula ma Haleokane, E hoomaka ana ma Ke Kihiki Kihiki, a e holo ana Ak, 63, Hi, 322, paauku e pili ana i ke Hoo, Ak, 20, Hi, 325, paauku e pili ana i ke Wahine, Ak, 5 7/8, Hi, 338, e pili ana me ke Wahine, Ak, 15 1/2, Hi, 350 paauku e pili ana i ke Konoiki, i ke Kihiki mua, 9, Eka,

Apana 3, Kula ma Kaniho, E hoomaka ana ma Ke Kihiki Kihiki, a e holo ana Ak, 16, Hi, 430, paauku e pili ana i ke Konoiki, Ak, 68, Hi, 1530, paauku e pili ana i ke Konoiki, Ak, 42, Hi, 656, paauku e pili ana me ke Konoiki, Ak, 73, Hi, 2050, paauku e pili ana i ke Konoiki, i ke Kihiki mua, 8, 9/10 Eka,

Apana 4, Kula ma Haleokane, E hoomaka ana ma Ke Kihiki Kihiki, a e holo ana Ak, 35, Hi, 790, paauku e pili ana i ke Konoiki, Ak, 20, Hi, 550, paauku e pili ana i ke Konoiki, Ak, 52 1/2, Hi, 942, paauku e pili ana i ke Konoiki, Ak, 10, Hi, 594, paauku e pili ana i ke Konoiki, i ke Kihiki mua, 3, Eka,

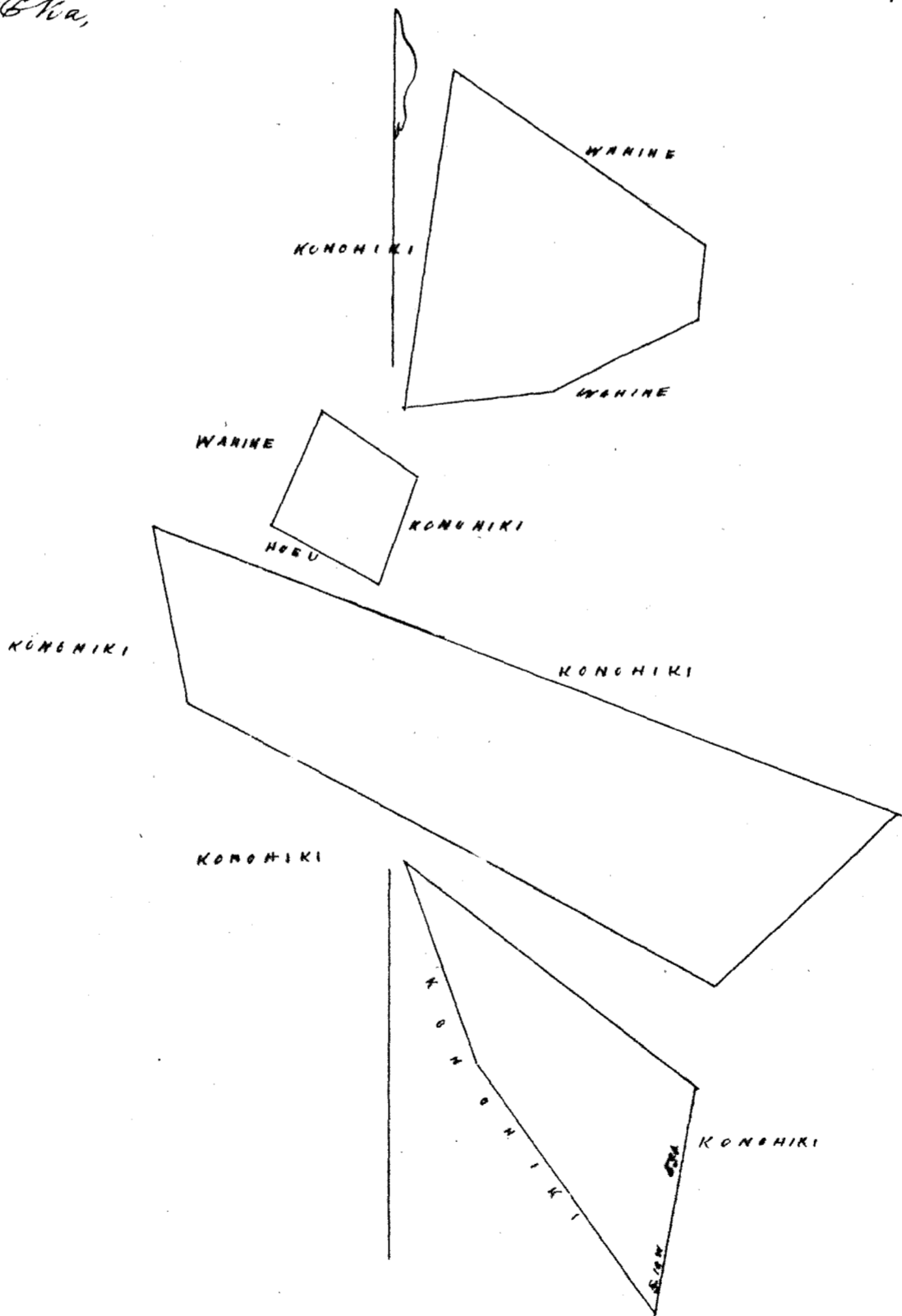

A. F. Turner
Luna ana aina

4 -
90
890
3
1550

Purpuka ma Keoheka & Honouliuli Kula Moai

Apana 1 Kula ma Kaamanoa Keoheka, Chomaha ana ma ke kahi Akau, a e holo ana He 64° Hi 320 pautu e pili ana i Waiohuli He 33° Ho 330 pautu e pili i Ke Kai He 68° Ho 285 pautu e pili ana me Ke Kahelu, Ak 27 1/2° Hi 350 pautu e pili ana me Ke Kai i ke kahi mua i Eka,

Apana 2 Kula ma Punohihewa Honouliuli Chomaha ana ma ke kahi Akau a e holo ana, He 80° Hi 235 pautu e pili ana i Ke Kaamanoa, He 26° Hi 84 pautu e pili ana i Ke Kaamanoa, Ak 83° Hi 860 pautu e pili ana i Ke Kaamanoa, He 31° Ho 130 pautu e pili ana i Ke Ke Honohiki He 63 1/2° Hi 350 pautu e pili ana me Ke Honohiki He 21° Ho 115 pautu e pili ana me Ke Makakahiho He 58° Ho 480 pautu e pili ana me Ke Makakahiho Ak 64 1/2° Ho 1100 pautu e pili ana me Ke Honohiki Ak 22° Hi 200 pautu e pili ana me Ke Honohiki i Ke kahi mua, 5 14/100 Eka,

Apana 3 Kula ma Kupalaiva Honouliuli Chomaha ana ma ke kahi Akau, a e holo ana, He 4° Hi 450 pautu e pili ana, i Ke Kamai He 12° Ho 390 pautu e pili ana i Ke Kamai, Ak 79° Ho 50 pautu e pili ana me Ke Honohiki Ak 40 1/2° Hi 830 pautu e pili ana i Ke Kaloehana i ke kahi mua, 2 4/100 Eka

9 Feby 1852

A. F. Turner
Luna ana aina

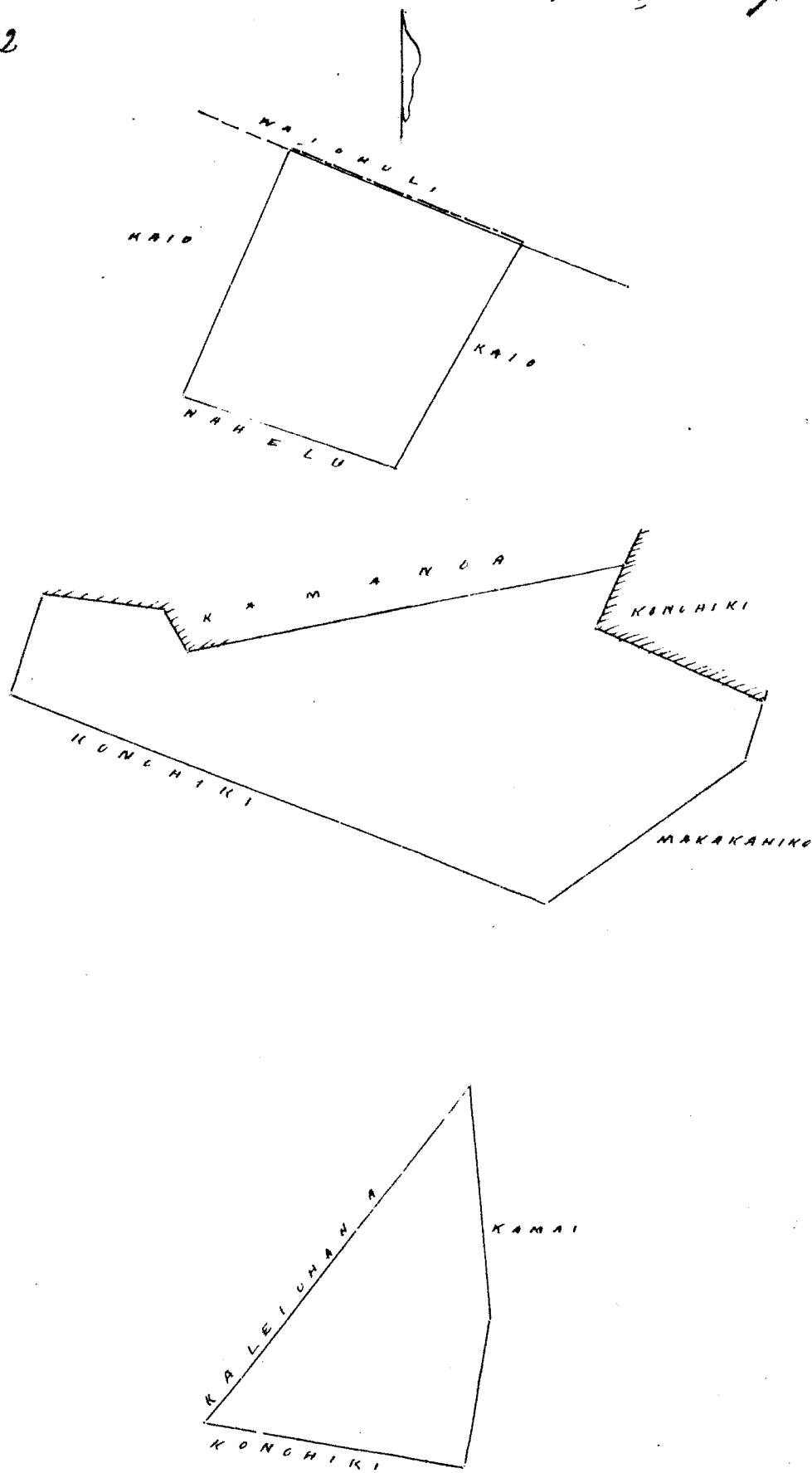

Wm Pau Loa #8

W. L. Lee

G. M. Robertson

J. H. Smith

J. Kekaulahao

Honolulu 5 Aug 1852

Kaulakane ma Umuapio 9 Koula Maui

Apana 1 Koula ma Kaulakane

E hoomaka ana ma ke kiki Hema, a e holo ana, Ak 68° Hi 155 pautu Kauhiki Ak 22° Hi 700 pautu Kauhiki Ak 68° Hi 155 pautu Kauhiki Ak 22, Ho 700 pautu Kauhiki i ke kiki mua 1 5/100 Eka,

Apana 2 Koula ma "Aalelan"

E hoomaka ana ma ke kiki Akau, a e holo Ak 68° Hi 885 pautu ma ke kiki Hi 59° 368 Ho pautu e pili ana ma Kauhiki Ak 77 1/2° Hi 920 ma ke Kauhiki Ak 46° Hi 587 pautu ma ke Oleole, i ke kiki mua, 3 1/2 Eka,

Apana 3 Koula ma "Waiipitopiti"

E hoomaka ana ma ke kiki Akau a e holo ana, Ak 80° Hi 674 pautu ma ke Kauhiki Ak 12° Ho 210 pautu ma ke Kaulakane, Ak 85° Ho 550 pautu ma ke Kauhiki Ak 15° Ho 280 pautu ma ke Kauhiki i ke kiki mua, 1 1/2 Eka,

Apana 4 Koula ma Kaulakane

E hoomaka ana ma ke kiki Hema, a e holo Ak 80 1/2° Ho 730 pautu ma ke Kauhiki Ak 1° Hi 960 pautu ma Kauhiki Ak 75 1/2° Hi 825 pautu ma ke Kauhiki Ak 6° Ho 870 pautu ma Kauhiki ke kiki mua, 7 Eka

1.50
3.50
1.50
7.50

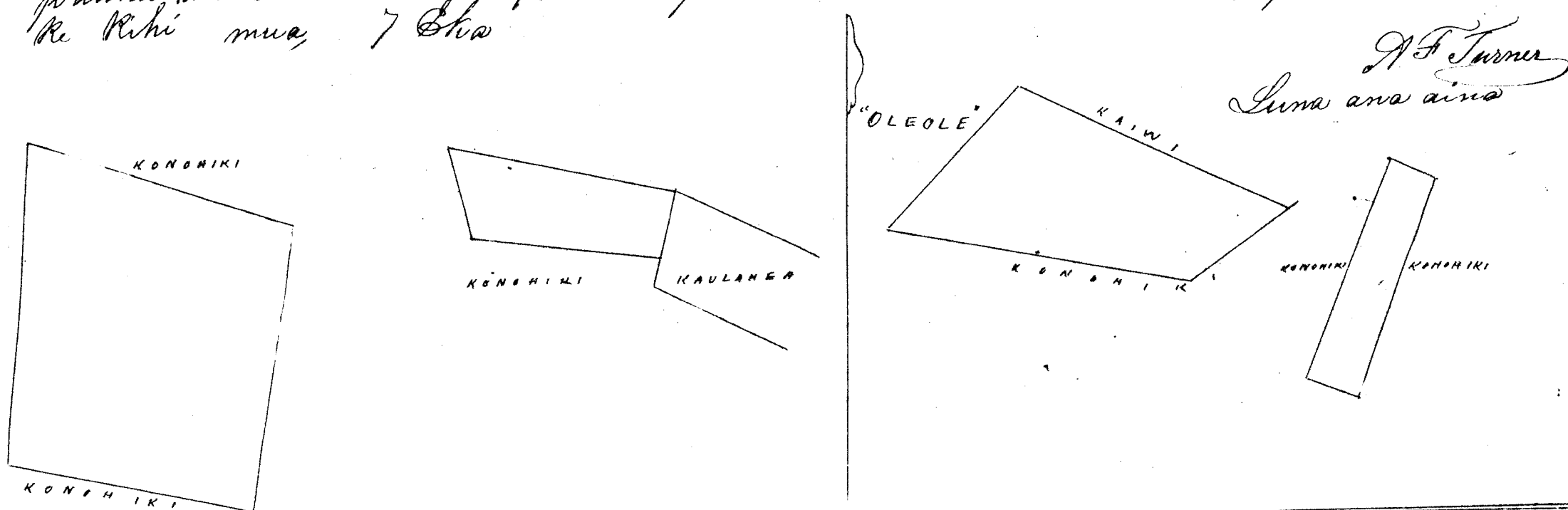

Wku Pau Ira # 10
W. L. Lee
G. M. Robertson
J. H. Smith

Honolulu 5 Aug 1852

J. Kaulakane

Helu 5476 Lapaku

Honolulu Koula Maui

Lapaku ma Honolulu

Apana 1 Koula + Kalo ma Malapua
E hoomaka ana ma ke kiki Hema a e holo ana, Ak 15° Hi 580 pautu e pili ana i ke ke Kauhiki Ak 18° Hi 300 pautu e pili ana i ke ke Kauhiki Ak 18° Hi 240 pautu e pili ana i ke ke Kauhiki Ak 18° Ho 593 pautu e pili ana i ke alani, Ak 51° Hi 658 pautu e pili ana i ke ke Kauhiki i ke kiki mua, 3 4/100 Eka,

42

Apana 2 Koula ma Kapakahawai

E hoomaka ana ma ke kiki Akau, a e holo ana Ak 6° Hi 450 pautu e pili ana i ke alani Ak 6° Hi 405 pautu e pili ana i ke ke Kauhiki Ak 6° Hi 390 pautu e pili ana, ma ke Kauhiki Ak 6° Ho 510 pautu e pili ana i ke Kauhiki i ke kiki mua 16 3/100 Eka

A.F. Turner
Luna ana aino

Koula Maui
23 Jan 1852

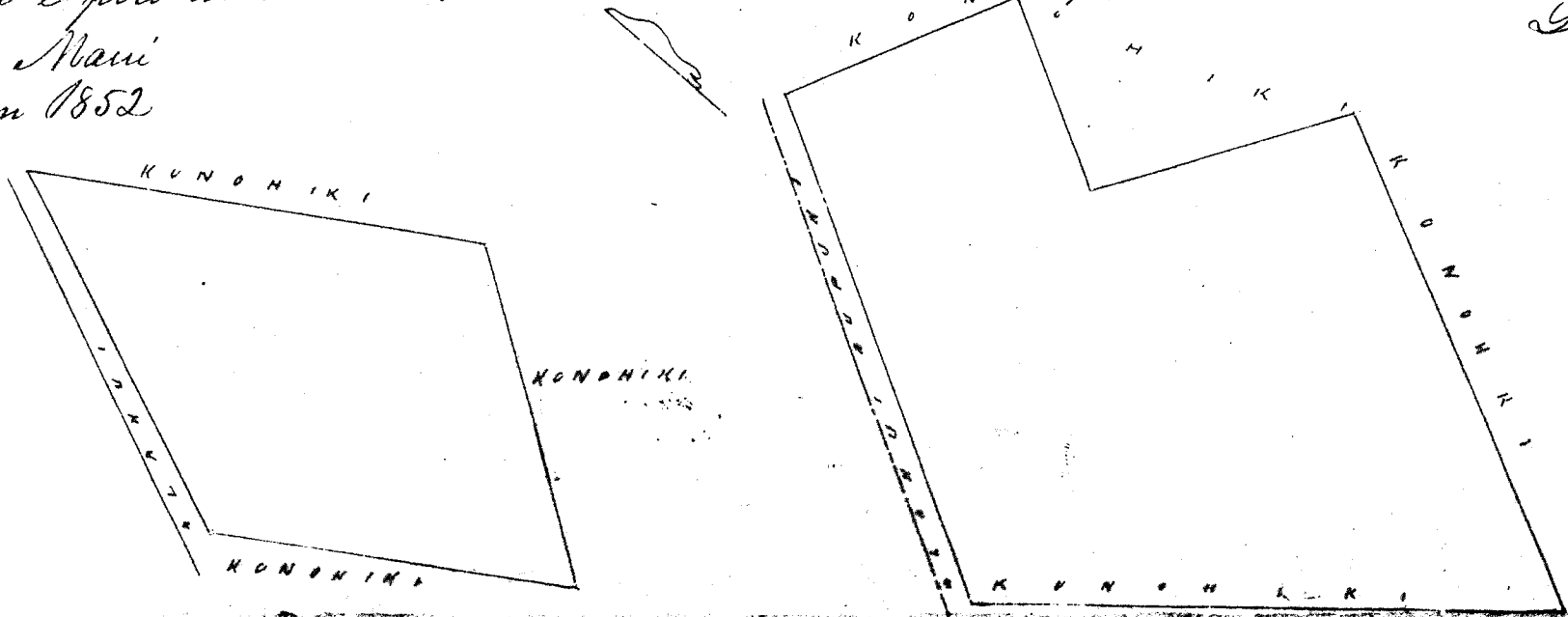

Uluke Pa. Lea 7

W. L. Lee

G. M. Robertson

J. H. Smith

Honolulu 5 Aug 1852

A. Kaulahai

Hoelu 4567 Wahine

Pulehuiki Kula Maui

Wahine Pulehuiki Kula Maui

Apana 1. Kula ma Keaku. Chromatika ana ma ke kiki Suma a e holo ana Ak 52° No 628 paunku e pili ana i ke ke Konoiki Ak 16 1/2° No 1020 paunku e pili ana me ke Konoiki Ak 65° No 560 paunku e pili ana me ke Konoiki Ak 15° No 1150 paunku e pili ana me ke Konoiki i ke kiki mua 6 15/100 Eka.

Apana 2. Kula ma H alokane. Chromatika ana ma ke kiki Kimoana e holo ana Ak 87° No 845 paunku e pili ana i ke ke Konoiki Ak 29° No 577 paunku e pili ana me ke Kapono Ak 86° No 678 paunku e pili ana me Kaniko Ak 42° No 680 paunku e pili ana me Konoiki i ke kiki mua 4 Eka.

Apana 3. Kula ma Keaku. Chromatika ana ma ke kiki Akau A e holo ana Ak 40 No 300 paunku e pili ana i ke ke Konoiki Ak 54° No 380 paunku e pili ana me ke Konoiki Ak 41 No 275 paunku e pili ana i ke Kapono Ak 49° No 369 paunku e pili ana me Konoiki i ke kiki mua, 1 Eka.

Apana 4. Kula ma Keaku. Chromatika ana ma ke kiki Kema a e holo ana Ak 74 1/2° No 1000 paunku e pili ana i ke Kaniko Ak 15° No 500 paunku e pili ana me Kema Ak 82 1/2° No 962 paunku e pili ana i ke Ak, Ak 11 No 637 paunku e pili ana me Ak i ke kiki mua, 5 58/100 Eka.

Apana 5. Kula ma Kuluineone Chromatika ana ma ke kiki Akau, a e holo ana Ak 29° No 473 paunku e pili ana i ke Anukia Ak 68° No 753 paunku e pili ana me Kapono Ak 25° No 470 paunku e pili ana me Kapono Ak 76 No 1200 paunku e pili ana me Konoiki i ke kiki mua 3 8/10 Eka, 5 Feb 1852.

A. F. Turner
Luna ana aia

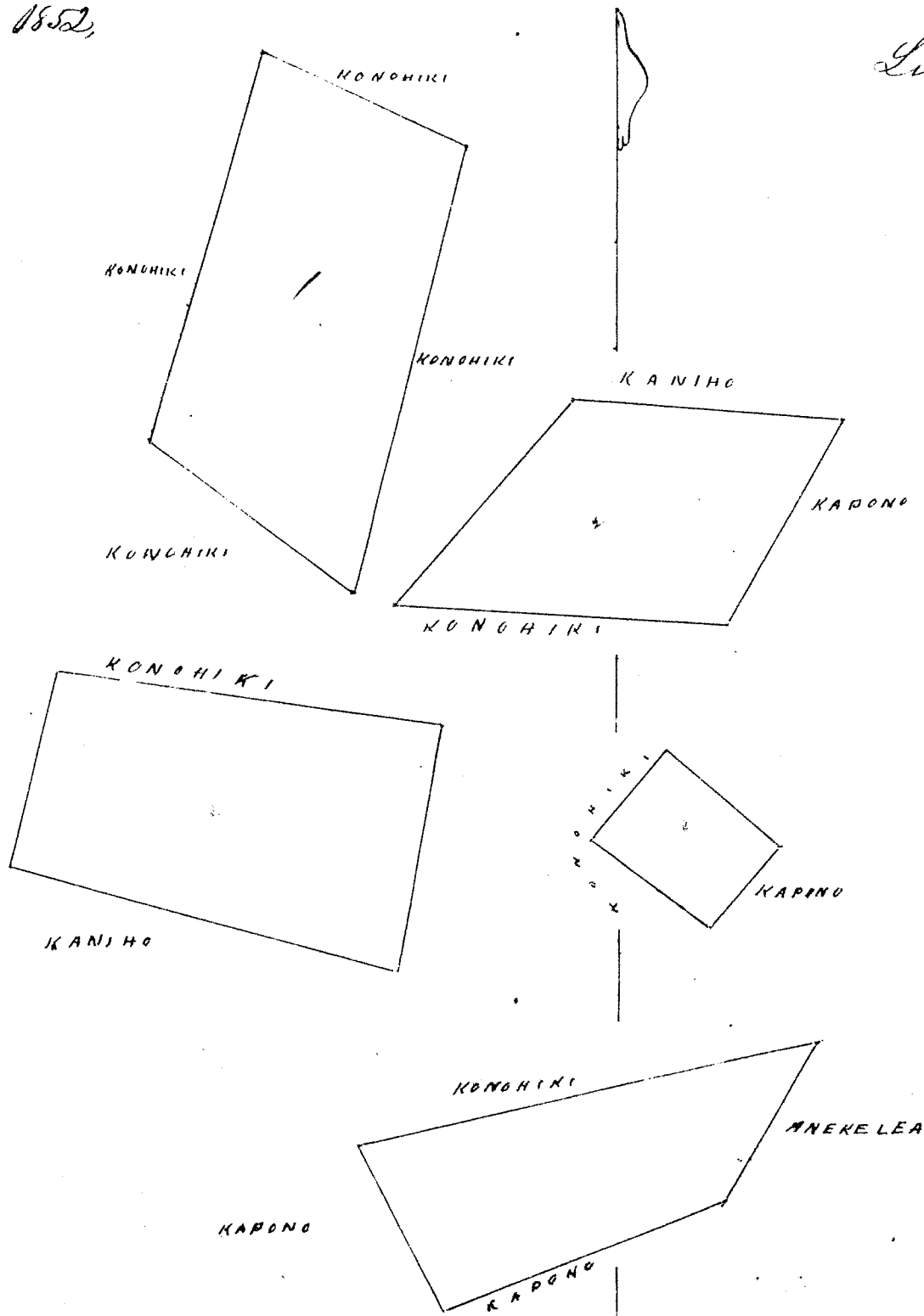

Wku Pau Loa # 15

85

W. L. Lee
G. M. Robertson
J. M. Smith

Honolulu 5 Aug 1852

J. Stepanulaha

Helu 527^B Kawana

Honolulu Kula Maui

Kawana ma Honolulu & Aae Kula Maui

Apana 1 Kula ma Haukaulua, Honolulu

E hoomaka ana ma ke kahi Aae, a e holo ana, He 77 He 300 pautu e pili ana i ke Kahawai
He 4 He 990 pautu e pili ana i ke Konoiki He 78 He 680 pautu e pili ana i ke Konoiki He 26
He 1000 pautu e pili ana ma ke Aae i ke Kahi mua, 4 1/2 Eke,

Apana 2, Kula ma Aae

E hoomaka ana ma ke kahi Kihina Aae, a e holo ana, He 23 He 505 pautu e pili ana i ke
Ke Konoiki He 80 He 500 pautu e pili ana i ke Kahawai He 6 He 210 pautu e pili ana
i ke ke Konoiki He 87 He 650 pautu e pili ana ma ke Konoiki i ke Kahi mua 2 1/2 Eke

Kula Maui
25 Jan 1852

A. F. Turner
Luna ana aina

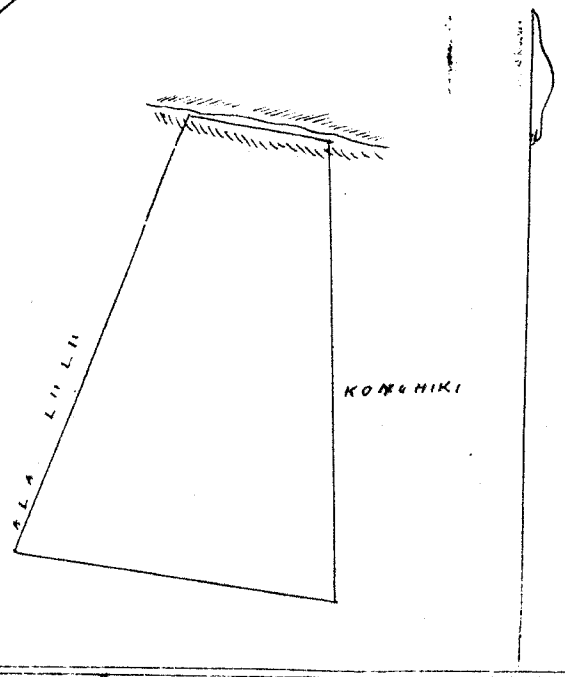
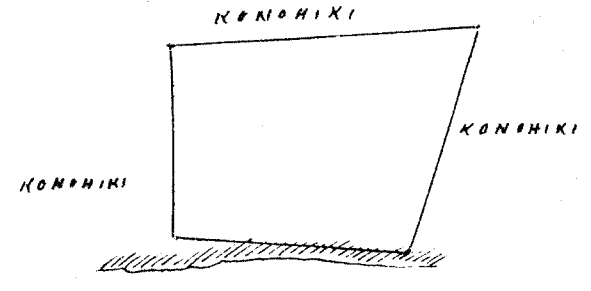

Wku Pau Loa # 8

W. L. Lee
G. M. Robertson
J. M. Smith
J. Stepanulaha

Honolulu 5 Aug 1852

Helu 846^B Kailianu

Waiaho Kula Maui

Kailianu ma Waiaho Kula Maui

Aina Kula & Kahuahele ma "Kalihi"

E hoomaka ana ma ke kahi Aae a e holo ana, He 77 He 550 pautu e pili ana i ke Konoiki
He 13 1/2 He 426 pautu e pili ana i ke Konoiki He 78 He 730 pautu e pili ana ma
ke Konoiki He 22 He 760 pautu e pili ana ma ke Konoiki i ke Kahi mua 2 1/2 Eke

28 Jan 1852

A. F. Turner
Luna ana aina

Wku Pau Loa # 6

W. L. Lee
G. M. Robertson
J. M. Smith
J. Stepanulaha

Honolulu 5 Aug 1852

Hoelu 9671 Kekahuna

Pulehu Kula Maui

Kekahuna ona Pulehu Kula Maui

Apana 1 Kula ona Kaliki E hoomaka ana ma ke kiki Nema a e holo ana Ak 6° Hi 494 paunani e pili ana i ke Konoiki Ak 70° Ho 360 paunani e pili ana i ke Halehewa Ak 20° Ho 422 paunani ma ke Konoiki Ak 54° Hi 474 paunani e pili ana i ke Konoiki i ke kiki onua 1 3/10 Eka,

Apana 2 Kula ona E hoomaka ana ma ke kiki Akau, a e holo ana Ak 8° Ho 293 paunani e pili ana i ke Konoiki Ak 70° Hi 356 paunani e pili ana i ke Konoiki Ak 43° Hi 244 paunani e pili ana ma ke Kapeho Ak 64° Ho 456 paunani e pili ana ma Kimpalai, i ke kiki onua 1 08/100 Eka,

Apana 3 Kula ona Kaliki E hoomaka ana ma ke kiki Akau, a e holo ana Ak 15° Ho 398 paunani e pili ana i ke Konoiki Ak 82° Hi 737 paunani e pili ana i ke Kahawai o Kamehame Ak 22 1/2° Hi 270 paunani e pili ana i ke Konoiki Ak 70 1/2° Ho 770 paunani e pili ana ma ke Konoiki i ke kiki onua, 2 7/10 Eka,

29 Jan 1852

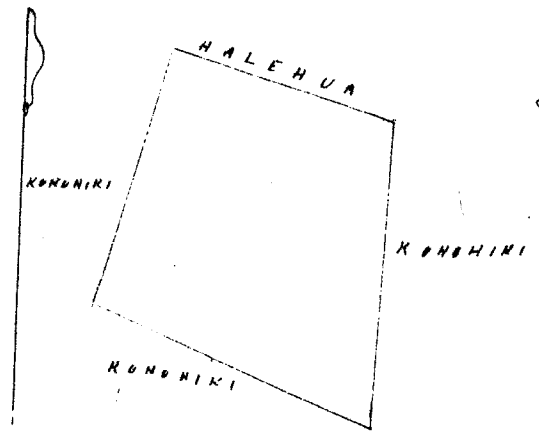
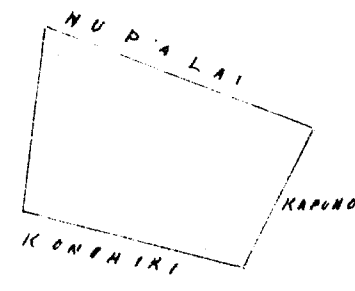
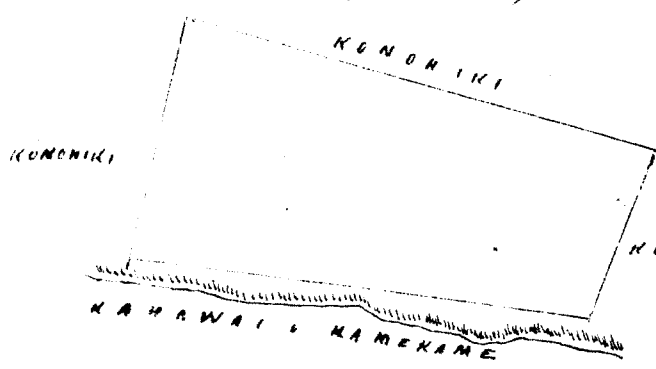

A. F. Turner
Luna Ana Aina

Wm. P. L. Lee
W. L. Lee
G. M. Robertson
S. H. Smith
S. H. Kaulahar

Honolulu 3 Aug 1852

Hoelu 8602 Koiwi

Onaopia Kula Maui

Koiwi ona Onaopia 10

Apana 1 Kula ona Puakalanui E hoomaka ana ma ke kiki Nema a e holo ana Ak 33° Hi 1130 paunani e pili ana i ke Konoiki Ak 63° Ho 815 paunani e pili ana ma ke Konoiki Ak 34 1/2° Hi 1150 paunani e pili ana ma ke Konoiki Ak 65° Hi 850 e pili ana i ke Kahawai i ke kiki onua 9 Eka

Apana 2 Kula ona Kahawai E hoomaka ana ma ke kiki Nema a e holo Ak 25° Hi 600 paunani e pili ana i ke Konoiki Ak 65° Ho 450 paunani ma ke Konoiki Ak 25° Ho 600 paunani ma ke Konoiki Ak 65° Hi 150 paunani ma ke Konoiki i ke kiki onua 9/10 Eka,

Apana 3 Kula ona Pipio E hoomaka ana ma ke kiki Akau, a e holo Ak 74° Hi 396 paunani e pili ana i ke Konoiki Ak 68 1/2° Hi 730 paunani e pili ana ma ke Konoiki Ak 35° Ho 474 paunani e pili ana ma ke Konoiki Ak 44° Hi 400 paunani e pili ana ma ke Konoiki Ak 27° Ho 700 paunani e pili ana ma ke Konoiki Ak 28 1/2° Hi 360 paunani e pili ana ma ke Konoiki i ke kiki onua 3 93/100 Eka

15 Jan 1852

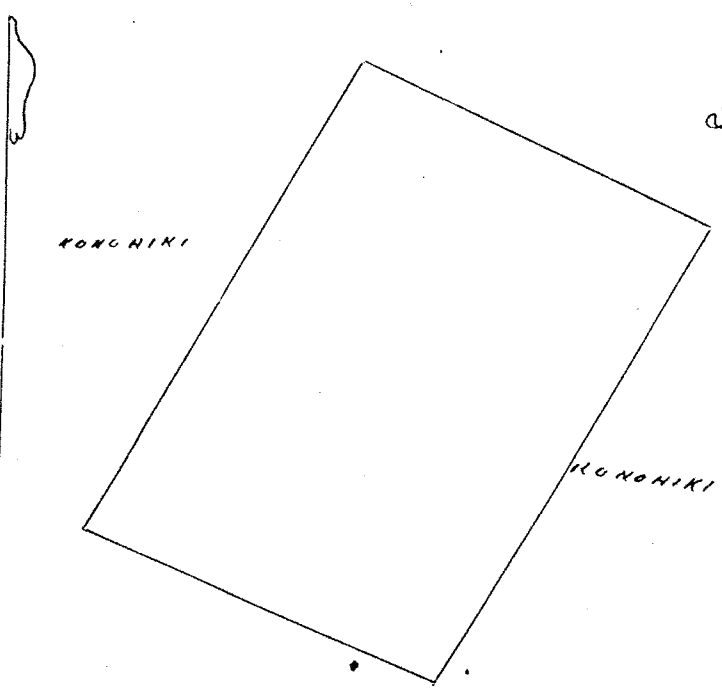
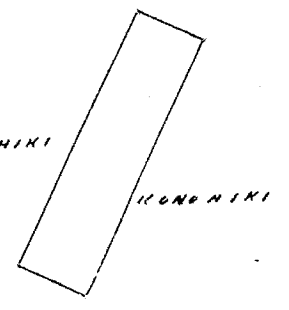
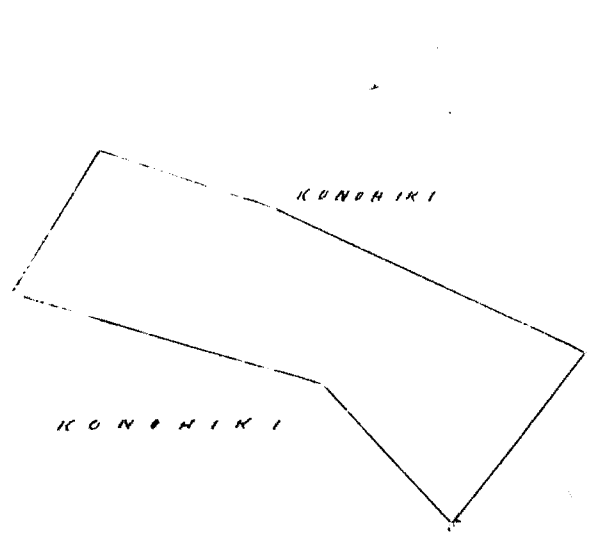

A. F. Turner
Luna ana aina

Wku Pau Loa # 10

W. L. Lee
G. M. Robertson
J. H. Smith

Honolulu 5 Aug 1852

Waku 6415 Keekua

Keohea Kula Maui

Keohea ma Keohea Kula Maui

Apana 1 Kula ma Paliku E hoomaka ana ma ke kahi Akaui, a e holo ana, He 79 1/2 He 890 pautu e pili ana i ke KahuluKaa, He 5 He 250 pautu e pili ana me ke Honohiki He 11 He 580 pautu e pili ana me Honohiki AK 77 1/2 He 11,00 pautu e pili ana me Honohiki AK 24 He 640 pautu e pili ana me Aka AK 15 He 110 pautu e pili ana me Aka, i ke kahi mua, 7 56/100 Eka

Apana 2, Kula ma Kaluahana

E hoomaka ana ke kahi Akaui a e holo ana He kahi 400 pautu e pili ana i ke Kachukulani He 39 He 32 pautu ma ke Kachukulani He kahi 400 pautu e pili ana me ke Kachukulani AK 63 He 200 pautu e pili ana me ke Kachukulani He 82, He 415 pautu e pili ana me ke Kachukulani He 20 1/2 He 590 pautu e pili ana me Kahili He 85 He 940 pautu e pili ana me Mana He 72 He 680 pautu e pili ana me ke Alanui AK 3 He 682 pautu e pili ana me ke Honohiki AK 14 He 410 pautu e pili ana me Honohiki i ke kahi mua 11 33/100 Eka

10 Feby 1852

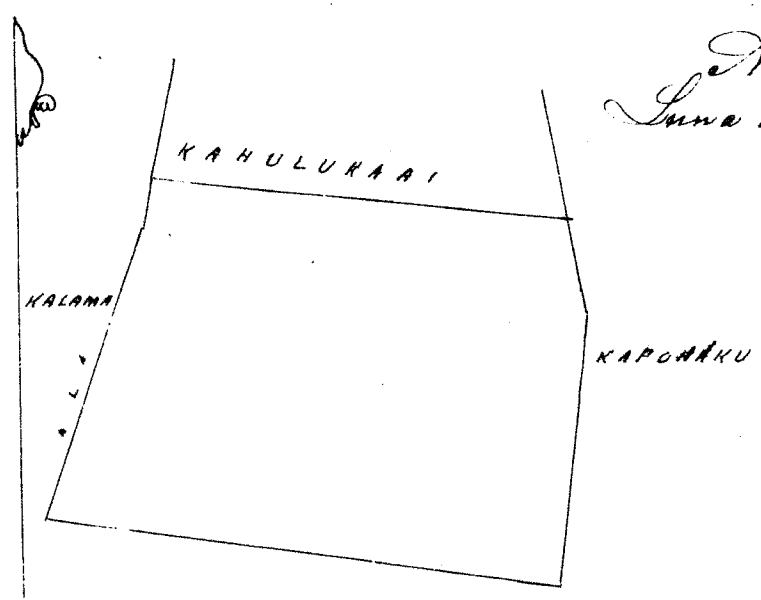
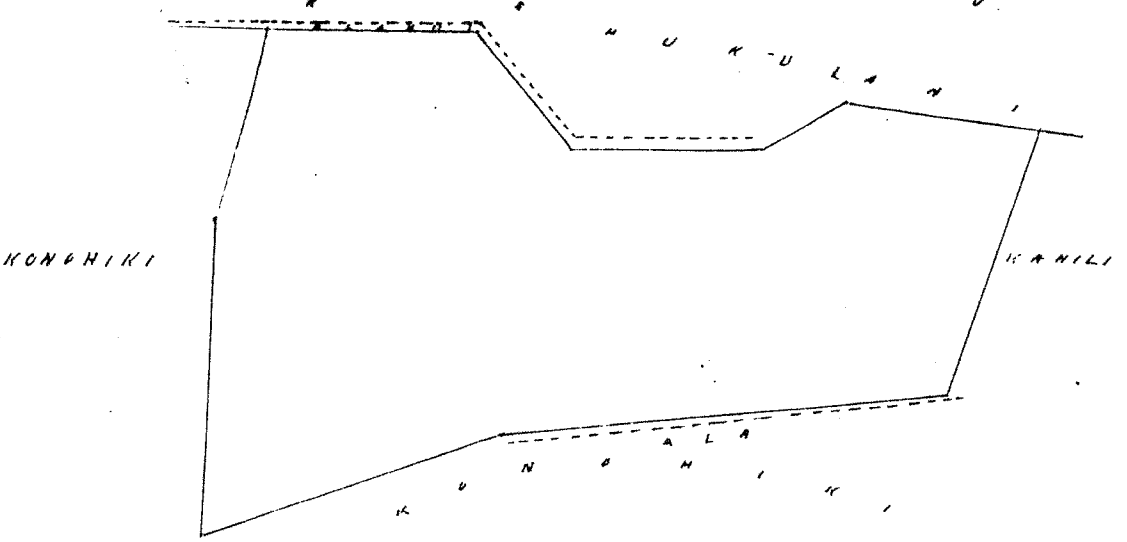

A. F. Turner
Luna ana aino

Wku Pau Loa # 12

W. L. Lee
G. M. Robertson
J. H. Smith
J. Kikaulahao

Honolulu 5 Aug 1852

Waku 10639 Pa

Keohea Kula Maui

Pa ma Keohea Kula Maui

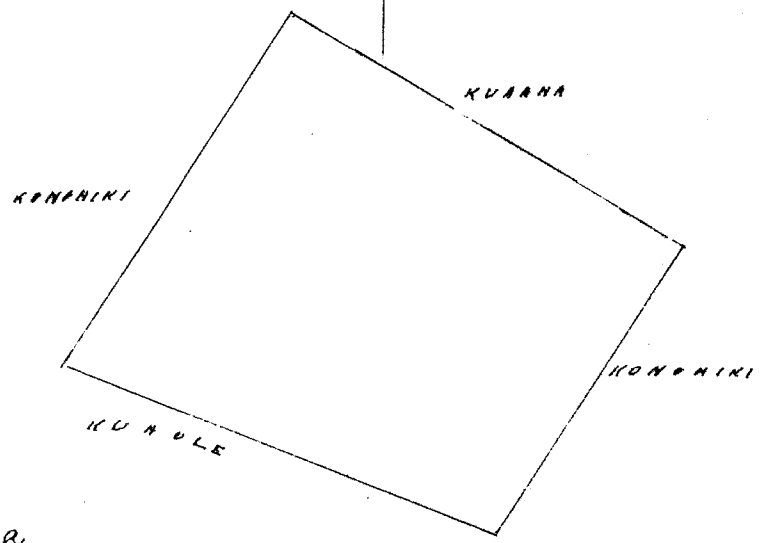

Aina Kula Ma

E hoomaka ana ma ke kahi Akaui a e holo ana, He 31 1/2 He 442 pautu e pili ana i ke ke Honohiki He 72 He 422 pautu e pili ana me Kuaale, AK 32 He 563 pautu e pili ana me ke Honohiki AK 62 He 472 e pili ana me Kuaana i ke kahi mua 1 9/10 Eka.

10 Feby 1852

A. F. Turner
Luna ana aino

Uku Pau Loa #4

W. L. Lee

G. M. Robertson

J. Kekaulaha

J. H. Smith

Honolulu 5 Aug 1852

Keu 6738 Luleluka

Waiohuli Kula Maui

Luleluka ma Waiohuli Kula Maui

Apana 1 Kula & Pahale ma Kahilinaewae E hoomaka ana ma ke kahi hema a e holo ana AK 50 Ki 263. pautu e pili ana i ke Honohiki AK 34 Ki 322 pautu e pili ana one ke ke Honohiki Ki 61 Ki 300 pautu e pili ana me ke ke Honohiki Ki 40. Ki 370 pautu e pili ana me ke ke Honohiki i ke kahi mua, 1 Eka

Apana 2 Kula ma Laie E hoomaka ana ma ke kahi hema a e holo ana AK 66. Ki 719 pautu e pili ana i ke ke Honohiki AK 37. Ki 158 pautu e pili ana me ke ke AK 66. Ki 70 Ki 775 pautu e pili ana one ke ke Honohiki Ki 46. Ki 241 pautu e pili ana me ke e hana i ke kahi mua, 1 3/10 Eka,

Apana 3 Uala lili ma "Puco" E hoomaka ana ma ke kahi hema a e holo ana Ki 28 Ki 149 pautu e pili ana i ke kahi, Ki 59 Ki 490 pautu e pili ana i ke Hoopiopio Ki 33 Ki 195 pautu e pili ana me ke Hoopiopio Ki 74 Ki 495 pautu e pili ana me ke Hoopiopio AK 28 Ki 250 pautu e pili ana me ke Hoopiopio AK 60 Ki 950 pautu e pili ana me Honohiki i ke kahi mua 2 1/4 Eka,

26 Jan 1852

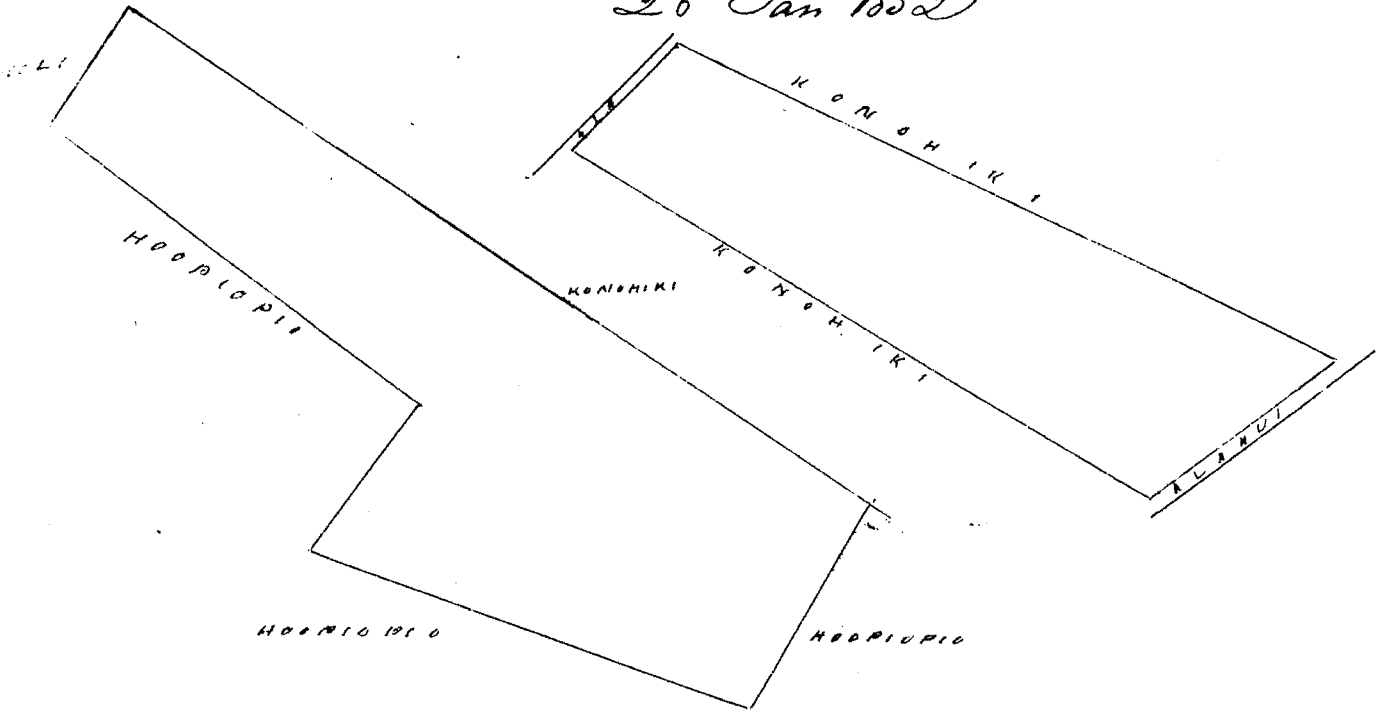

A. F. Turner
Luna ana aina

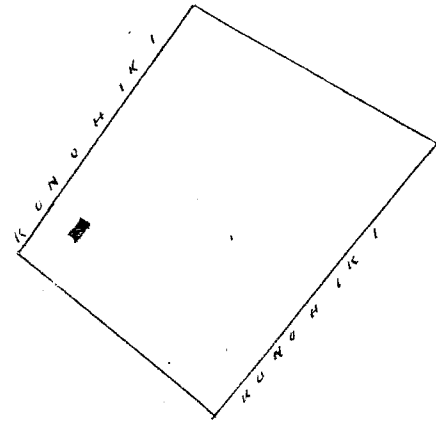

Uku Pau Loa #7

W. L. Lee

G. M. Robertson

J. Kekaulaha

J. H. Smith

Honolulu 5 Aug 1852

Keu 5294 Koi

Kailua Honolulu Kula Maui

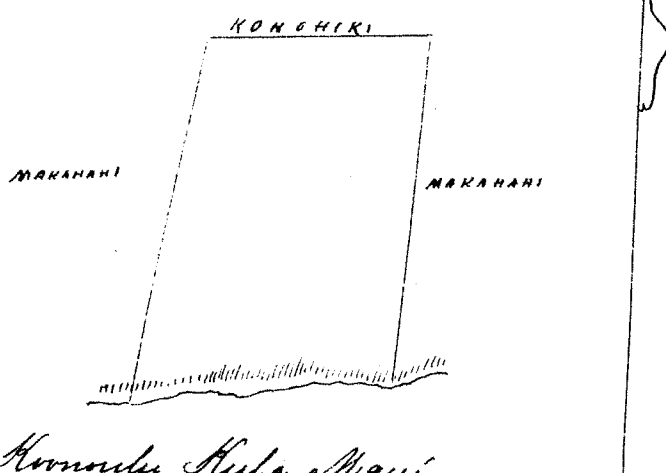

Koi ma Kailua Honolulu Kula Maui
Aina Kula, E hoomaka ana ma ke kahi hema a e holo ana, AK 7 1/2 Ki 740 pautu e pili ana i ke Makahani Komohana 470 pautu ma ke Honohiki Ki 15 Ki 800 pautu e pili ana me ke Makahani ma ke Kahawai, a e holo ana i ke Kahawai i ke kahi mua 3 1/10 Eka

29 Jan 1852

A. F. Turner
Luna ana aina

Wks Pau Lea \$5

W. L. Lee
G. M. Robertson
J. Kekaulahao
J. H. Smith

Honolulu 5 Aug 1852

Hoelu 64 1/4 Heawe

Waiohuli Kula Maui

" Heawe ma Waiohuli Kula Maui

Apana 1 Kula ma Luakini + Puutala Chromaka ana ma ke Pihiki Akau, a e holo ana He 85 He 1,000 pautu e pili ana i ke alanui He 17 He 600 pautu e pili ana i ke Konoiki He 89 He 1,305 pautu e pili ana me Konoiki AK 10 He 749 pautu e pili ana i ke Konoiki i ke Pihiki onua 7 1/4 Eka,

Apana 2 Kula Chromaka ana ma ke Pihiki Akau a e holo ana He 50 He 1,100 pautu e pili ana i ke Alanui He 24 He 400 pautu e pili ana i ke Konoiki AK 50 He 1,015 pautu e pili ana i ke Konoiki AK 14 He 430 pautu e pili ana i ke Konoiki i ke Pihiki onua 4 03/100 Eka

4 Feby 1852,

A. F. Turner
Luna ana aina

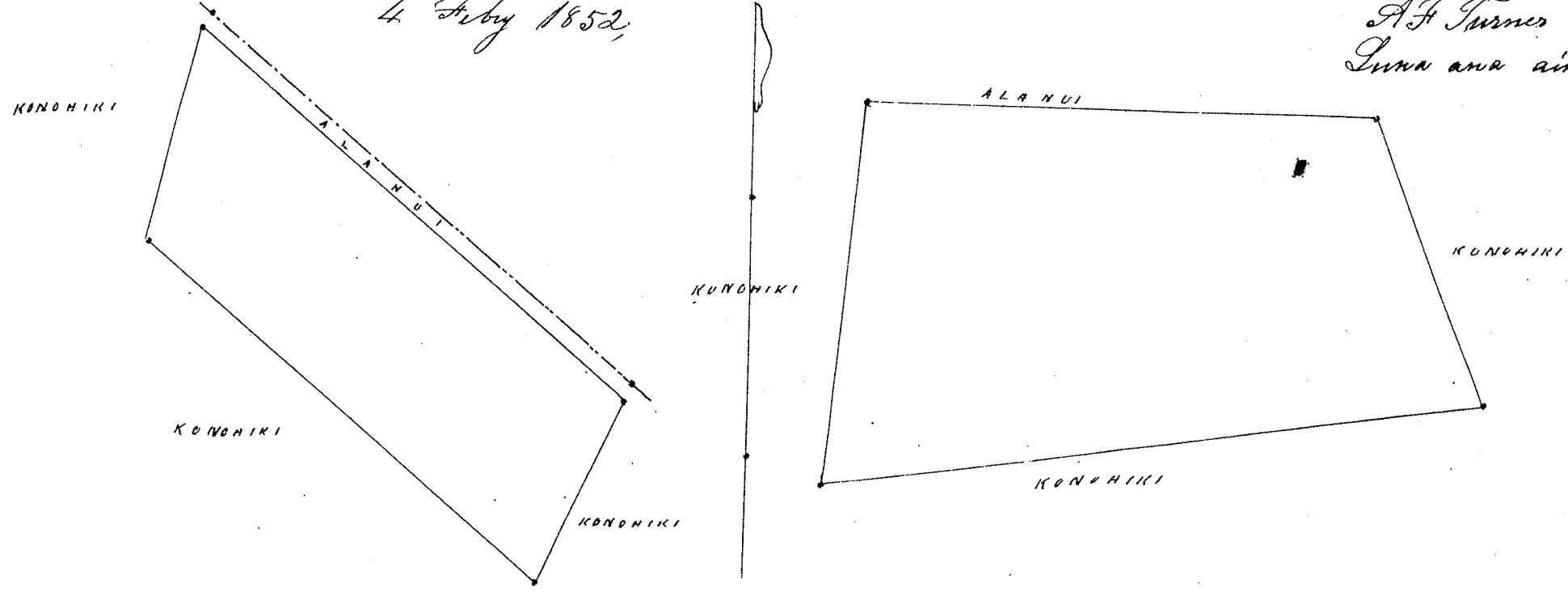

Wks Pau Lea \$10

W. L. Lee
G. M. Robertson
J. H. Smith

Honolulu 5 Aug 1852

Hoelu 79 1/2 K. Kalia

Honolulu Kula Maui

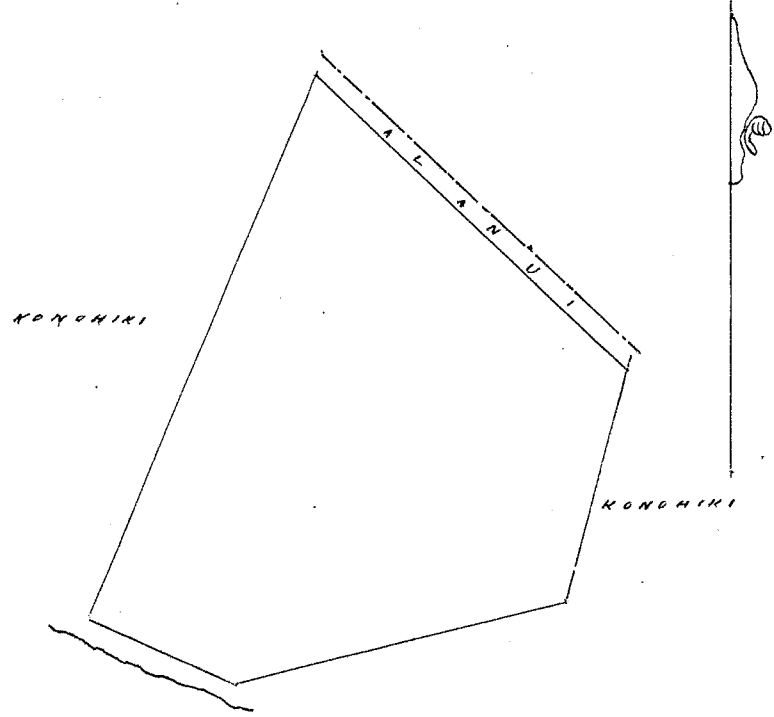

Kalia ma Kapakahawai Honolulu Kula Maui

Aina Kula Chromaka ana ma ke Pihiki Akau a e holo ana AK 69 He 170 pautu e pili ana i ke Kapahawai AK 22 He 630 pautu e pili ana i ke Konoiki He 48 He 452 pautu e pili ana me ke Alanui He 14 He 250 pautu e pili ana me ke Konoiki He 70 He 360 pautu e pili ana me ke Konoiki i ke Pihiki onua 2 1/10 Eka

Kula Maui
23 Jan 1852

A. F. Turner
Luna ana aina

Wm Pau Loa \$5

W. L. Lee
G. M. Robertson
J. Hekaulahao
J. H. Smith

Honolulu 5 Aug 1852

Heleu 6540 Halekahi

Keoheua Kula Maui

" Halekahi ma Keoheua Kula Maui

Apana 1 Kula ma Kaopununu E hoomaka ana ma ke kahi Akaun a e holo ana He 10' Ni 710 pautu e pili ana i ke ke Honohiki aiaa He 66 1/2 Ni 730 pautu e pili ana i ke ke Honohiki aiaa AK 9 Ni 580 pautu e pili ana i ke ke Honohiki aiaa AK 65 Ni 980 pautu e pili ana ma Kawai, i ke kahi mua, 4 85/100 Eka,

Apana 2, Kula ma Kaluakona, E hoomaka ana ma ke kahi Akaun a e holo ana He 34' Ni 410 pautu e pili ana i ke ke Honohiki He 50 Ni 750 pautu e pili ana i ke ke Honohiki AK 34 Ni 500 pautu e pili ana ma ke ke Honohiki AK 56 He 745 pautu e pili ana i ke ke Honohiki i ke kahi mua 3 37/100 Eka,

Apana 3, Kalo ma Waiuku E hoomaka ana ma ke kahi Kama a e holo ana, AK 25 Ni 213 pautu e pili ana i ke Palakai AK 67 He 737 pautu e pili ana i ke Kawaiaki He 25 He 280 pautu e pili ana i ke Palakai He 71 Ni 736 pautu e pili ana i ke Maiola, i ke kahi mua, 1 7/10 Eka

12 Feby 1852

A F Turner
Luna ana aiaa

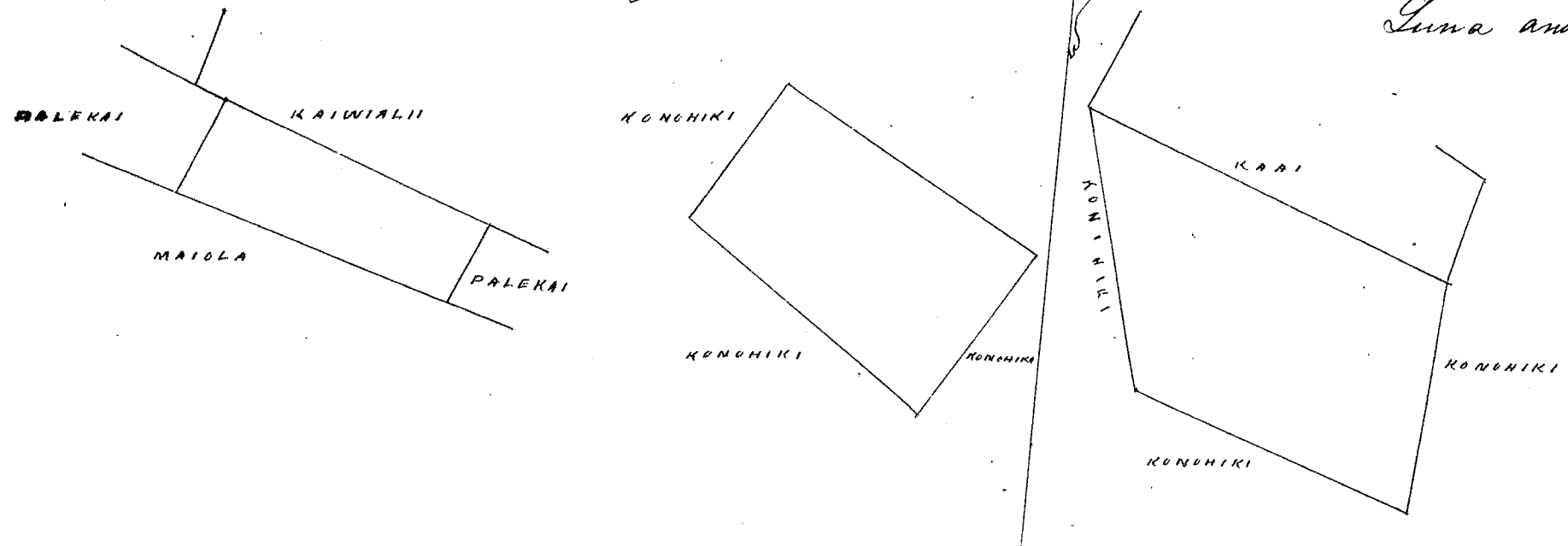

Wm Pau Loa \$8

W. L. Lee
G. M. Robertson
J. Hekaulahao
J. H. Smith

Honolulu 5 Aug 1852

Heleu 5397 Kawaii

Keonouhu Kula Maui

Kawaii Kailua Keonouhu Kula Maui

Aina Kula E hoomaka ana ma ke kahi Kama a e holo ana, AK 67 He 700 pautu e pili ana i ke pali AK 25 Ni 550 pautu e pili ana i ke Honohiki He 74 Ni 560 pautu e pili ana i ke Honohiki He 62 He 640 pautu e pili ana i ke Honohiki i ke kahi mua 3 7/10 Eka

26 Jany 1852

A F Turner
Luna ana aiaa

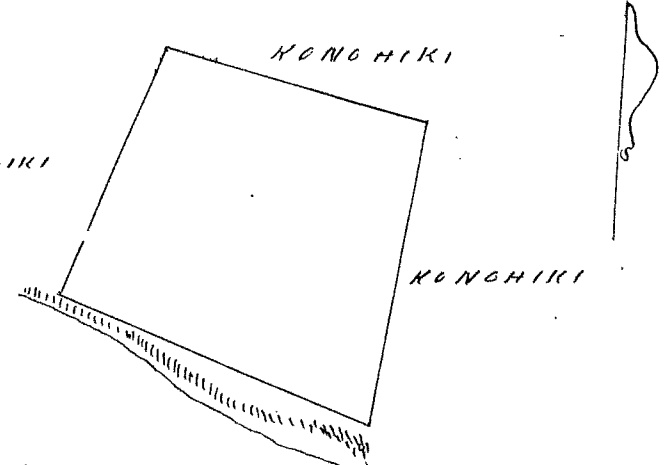

W. L. Lee
G. M. Robertson
J. Kekaulahoe
J. H. Smith

Honolulu 5 Aug 1852

Heleu 6425 Kauhukulani

Heheua Kula Maui

" Kauhukulani ma Heheua Kula Maui

Apana 1 Kula ma Penuhekeo & Abanoho Choomaka ana ma ke Kahi Heheua a e holo ana
Ak 9 1/2 No 1150 paauku e pili ana i ke ke Konoehiki Ak 70 No 475 paauku e pili ana i ke Kilaui
Ak 28 1/2 No 695 paauku e pili ana i ke Kilaui Ak 40 No 895 paauku e pili ana i ke Konoehiki i
ke Kahi mua 5 54/100 Eka.

Apana 2 Kula ma Kahoopuunui Choomaka ana ma ke Kahi Akau a e holo ana. Ak 16
No 750 paauku e pili ana i ke ke Konoehiki Akina 645 paauku e pili ana i ke Kilaui Ak 39 No 327 paauku e
pili ana i ke Kilaui Akina 400 paauku e pili ana i ke ke Akua Ak 36 No 200 paauku e pili ana i ke ke
Akua Ak 82 No 510 paauku e pili ana i ke Kilaui Ak 5 No 500 paauku e pili ana i ke Kahi Ak 63
No 420 paauku e pili ana ma ke Pualii Ak 75 1/2 No 1500 paauku e pili ana Kauhukulani i ke Kahi
mua 11 95/100 Eka.

10 July 1852

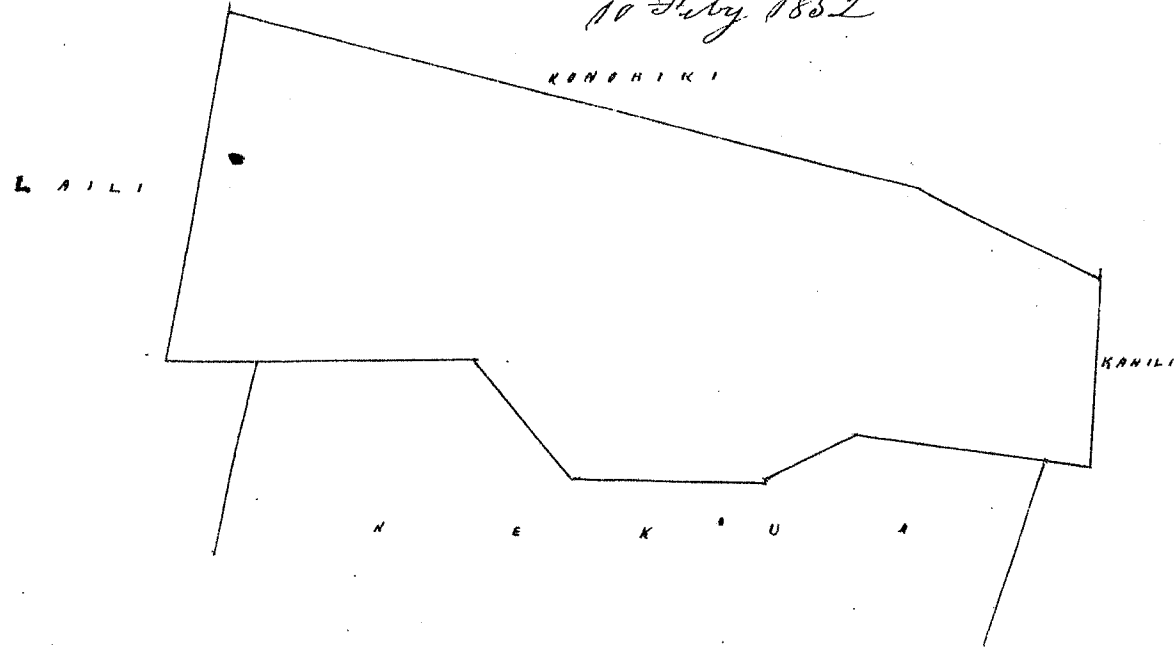

A. F. Turner
Luna ana aina

5.54
11.95
17.49

W. L. Lee
G. M. Robertson
J. Kekaulahoe
J. H. Smith

Honolulu 3 Aug 1852

Heleu 8655 Kahoopaki

Waiakoa Kula Maui

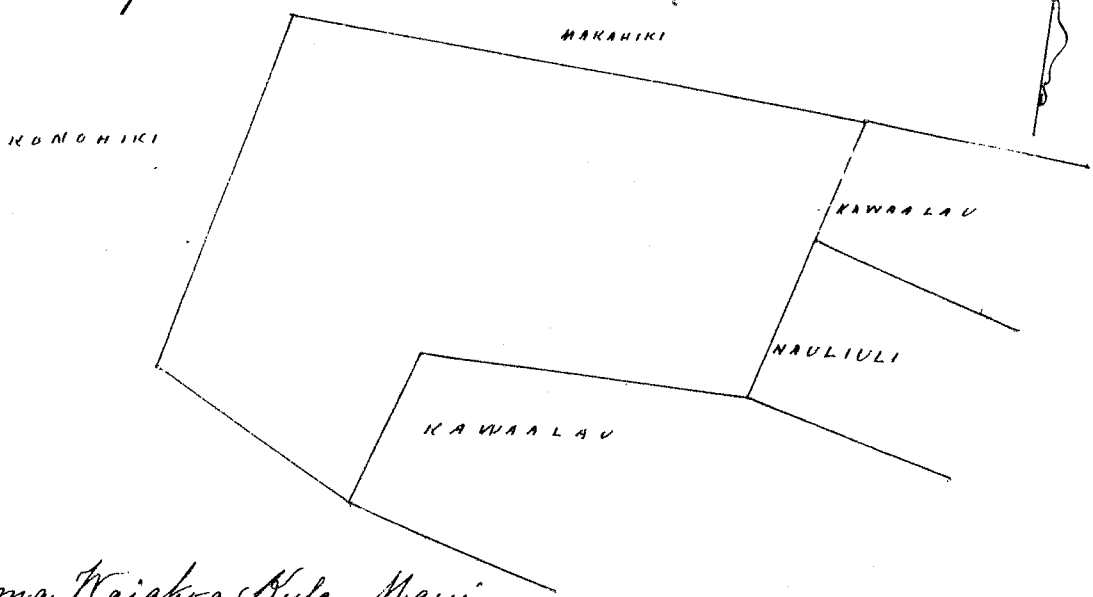

See Page 708 Vol. 7 (Part 2)
8.90 Vol 7
8.90 8
17.80

46

Kahoopaki ma Waiakoa Kula Maui

Kula ana Kahi Choomaka ana ma ke Kahi Heheua a e holo ana Ak 56 No 423 paauku e pili ana i ke ke Konoehiki
aina Ak 20 No 800 paauku e pili ana i ke ke Konoehiki aina Ak 80 No 1230 paauku e pili ana i ke Kilaui
Ak 23 1/2 No 630 paauku e pili ana ma ke Kilaui Ak 74 No 700 paauku e pili ana i ke Kilaui
Ak 25 1/2 No 344 paauku e pili ana i ke Kilaui, i ke Kahi mua 8 9/10 Eka.

Kula
26 Jan 1852

A. F. Turner
Luna ana aina

Wku Pan Loa # 9

W. L. Lee
G. M. Robertson
J. Kekaulahao
J. H. Smith

Honolulu 5 Aug 1852

Helu 10883 Pahuaia

Waiakoa Kula Maui

Pahuia ma Waiakoa Kula Maui

Kula ma Kaliki i hoomakaa ana ma ke kiki ike hema a e holo ana Ak 4 Ki 474 paunke e pili ana i ke Alanui Ak 79 Ki 740 paunke e pili ana i ke Honohiki Ak 24 Ki 630 paunke e pili ana i ke Honohiki Ak 89 Ki 1015 paunke e pili ana ma Kapaole i ke kiki ma 4 1/2 Eka

26 Jan, 1852.

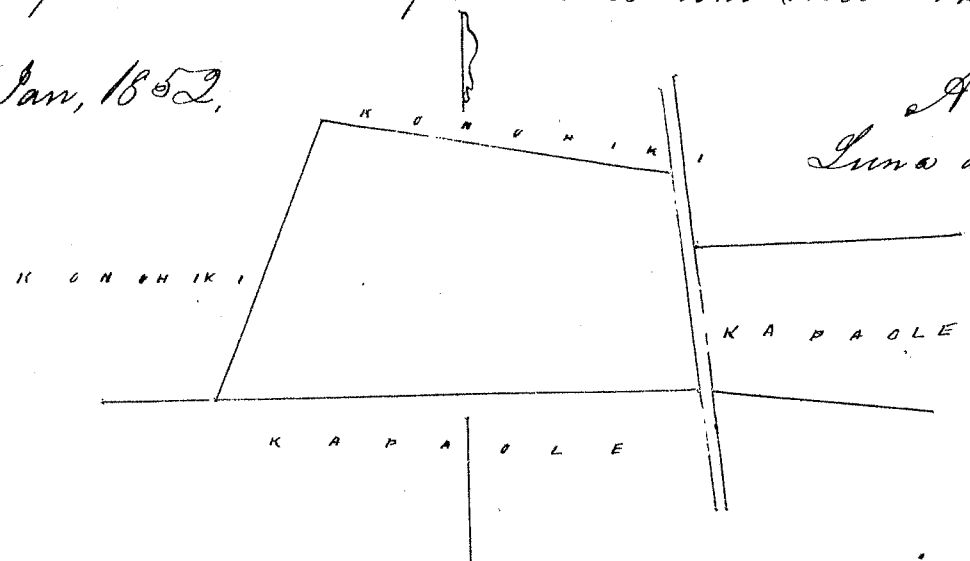

A F Turner
Luna ana aina

R. O. 7792

Wku Pan Loa # 6

W. L. Lee
G. M. Robertson
J. Kekaulahao
J. H. Smith

Honolulu 5 Aug 1852

Helu 10145 Mawaole

Waiakoa & Kealahou Kula Maui

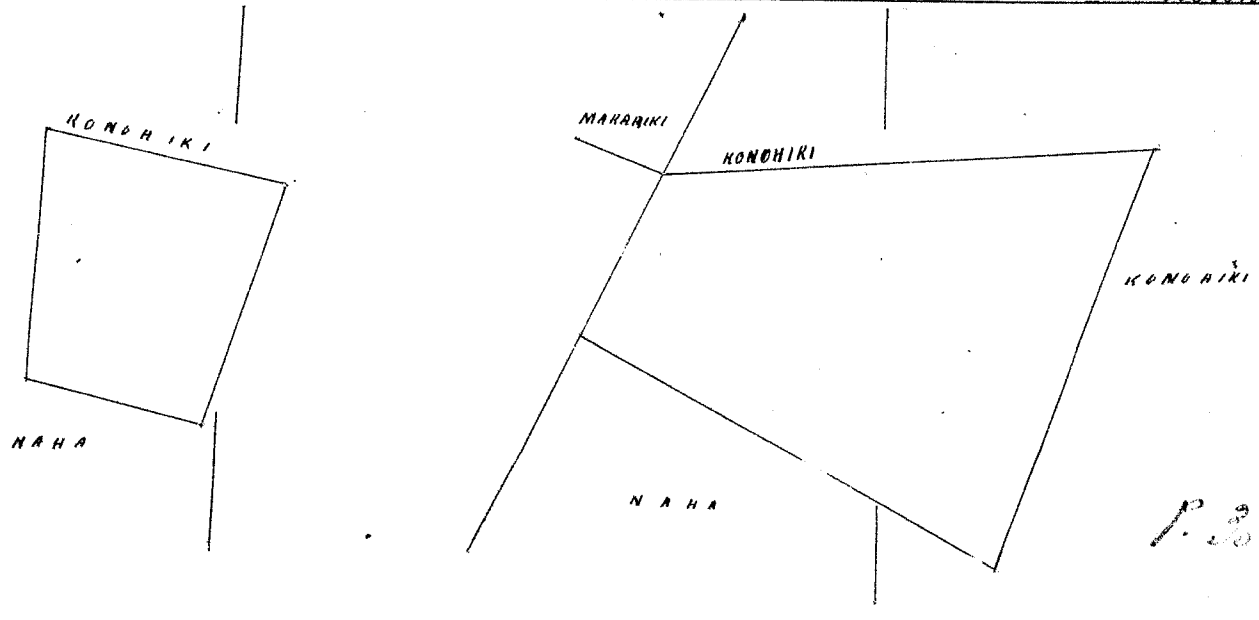

1. 3547 3.45
2. 30
6.50
5.80
7.01
15.81

Mawaole ma Kealahou & Waiakoa Kula Maui

Apawa 1 Kula ma Hanamali Kealahou i hoomakaa ana ma ke kiki hema a e holo ana Ak 77 1/2 Ki 400 paunke e pili ana i ke Naha, Ak 4 Ki 530 paunke e pili ana i ke ke Honohiki Ak 78 Ki 500 paunke e pili ana, i ke ke Honohiki Ak 17 Ki 530 paunke e pili ana i ke Honohiki i ke kiki ma 2 3/4 Eka,

Apawa 2 Kula ma Kaliki Waiakoa i hoomakaa ana ma ke kiki hema a e holo ana Ak 18 1/2 Ki 970 paunke e pili ana i ke Honohiki Ak 84 Ki 10,35 paunke e pili ana i ke Honohiki Ak 25 1/2 Ki 375 paunke e pili ana ma ke Honohiki Ak 63 Ki 1005 paunke e pili ana i ke Naha i ke kiki ma 6 1/2 Eka

26 Jan 1852

A F Turner
Luna ana aina

Wku Pan Loa # 9

W. L. Lee
G. M. Robertson
J. Kekaulahao
J. H. Smith

Honolulu 5 Aug 1852

Volu 4750 Maia 787777 Waiaho Kula Maui

KONOHIO NAULIULI KONOHIO

Hoolia keia Hoolia ana, aia ka pono ma ka Awao 707 Vol. 7.

Maia ma Waiaho Kula Maui

Kula ma Moouii E hoouaka ana ma ke Kiki Oka a e holo ana AK 25 Ki 380 pautu e pili ana i ke Kihikihi AK 63 Ki 12,00 pautu e pili ana i ke Nauliuli Ki 27 Ki 480 pautu e pili ana i ke Kihikihi ma ke Kahawai e Waiaho alaila e pili ana i ke Kahawai i ke Kiki ana, 5 1/5 Eka
26 Jan 1852

A. F. Turner
Luna ana aino

Wai Pau Loa # 7.
W. L. Lee
G. M. Robertson
J. Kekaulaao
J. H. Smith

Honolulu 5 Aug 1852

Volu 7971 Nauliuli 753155 Waiaho Kula Maui

Nauliuli ma Waiaho Kula Maui

Apana 1 Kula ma Kihiki E hoouaka ana ma ke Kiki Oka a e holo ana Ki 25 Ki 380 pautu e pili ana i ke Kahawai Ki 67 Ki 1020 pautu e pili ana i ke Kawaalau AK 9 Ki 350 pautu e pili ana i ke Maui AK 67 1/2 Ki 925 pautu e pili ana i ke Kawaalau i ke Kiki ana 3 2/5 Eka

Apana 2 Kula ma Moouii E hoouaka ana ma ke Kiki Oka a e holo ana Ki 27 Ki 300 pautu e pili ana i ke Kihikihi Ki 64 Ki 1600 pautu e pili ana ma ke Maia AK 16 Ki 950 pautu e pili ana ma ke Maui AK 85 Ki 11,00 pautu e pili ana ma ke Kapaole, i ke Kiki ana 7 1/10 Eka

A. F. Turner
Luna ana aino

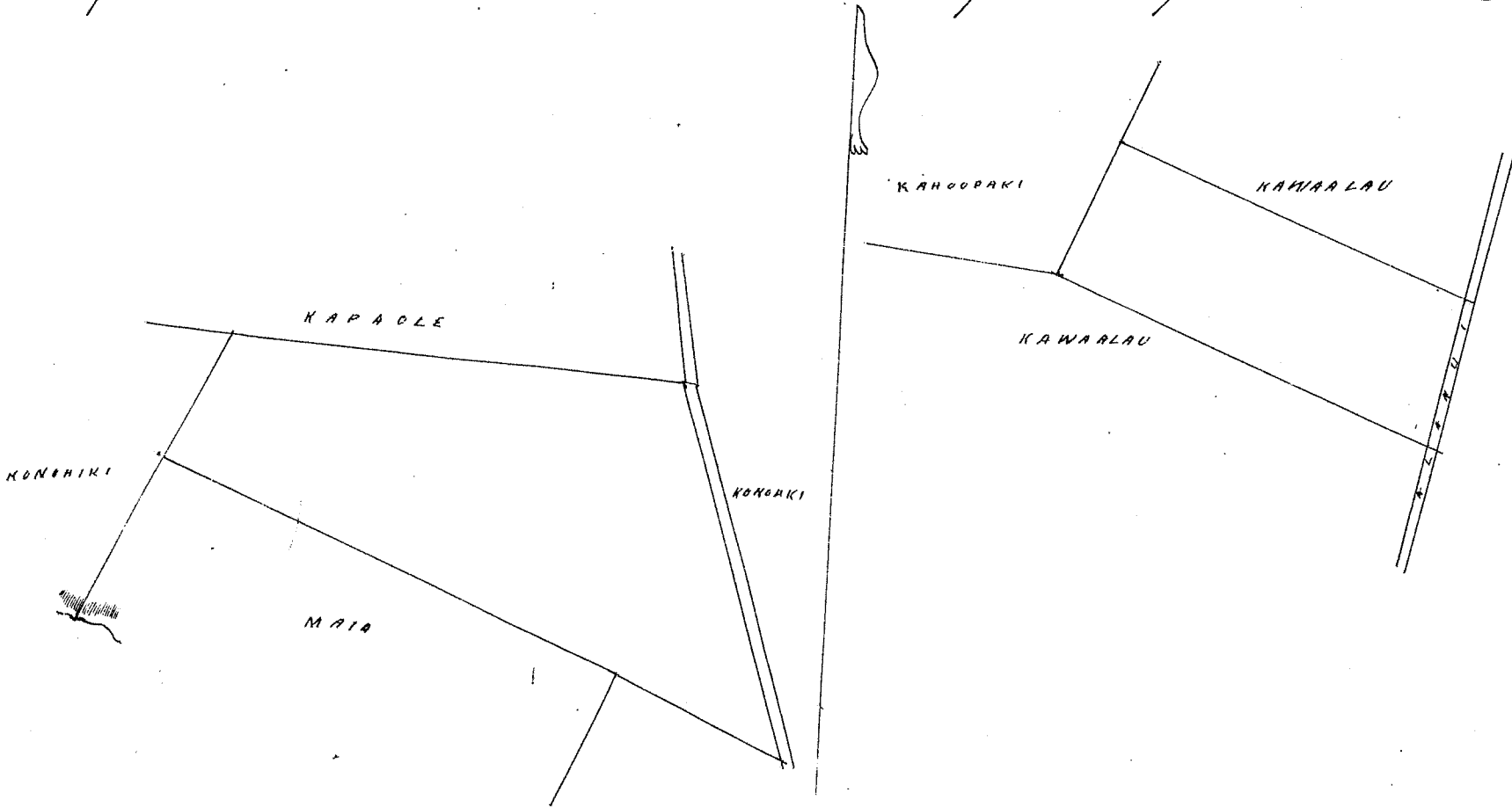

753155 E

Wai Pau Loa # 10
W. L. Lee
G. M. Robertson
J. Kekaulaao
J. H. Smith

Honolulu 5 Aug 1852

Paale ma Waiohuli Kula Maui

Apana 1 Kula ma Papanāini E hoomaka ana ma ke Kihī Kama a e holo ana Ak 28 He 257 paunke e pili ana i ke ke Konoiki Ak 60 He 828 paunke e pili ana i ke Ala He 28 He 156 paunke e pili ana i ke Puana He 50 He 850 paunke e pili ana i ke ke Konoiki i ke Kihī mua 7 9/10 Eka

Apana 2 Kula ma Pukohale E hoomaka ana ma ke Kihī Kama a e holo ana Ak 79 He 563 paunke e pili ana i ke Wainalu Ak 23 He 445 paunke e pili ana i ke ke Konoiki He 77 He 490 paunke e pili ana i ke ke Konoiki He 24 He 410 paunke ma ke Wainalu, i ke Kihī mua 2 1/10 Eka

Apana 3 Kula ma "Puo" E hoomaka ana ma ke Kihī Kama a e holo ana Kama 330 paunke e pili ana i ke ke Konoiki He 67 He 510 paunke e pili ana i ke Alanui He 85 He 850 paunke e pili ana i ke Alanui Ak 79 He 440 paunke e pili ana i ke Alanui Ak 29 He 346 paunke e pili ana i ke Konoia Ak 80 He 510 paunke e pili ana i ke Kāai Ak 85 He 1410 paunke e pili ana i ke ke Konoiki i ke Kihī mua 8 2/10 Eka

Apana 4 Kula ma Kohelapa E hoomaka ana ma ke Kihī Kama a e holo ana Ak 23 He 770 paunke e pili ana i ke ke Konoiki Ak 65 He 440 paunke e pili ana i ke ke Konoiki He 28 1/2 He 850 paunke e pili ana i ke ke Konoiki He 72 He 520 paunke e pili ana i ke ke Konoiki i ke Kihī mua 3 8/10 Eka

4 Febry 1852

A F Turner
Luna ana aia

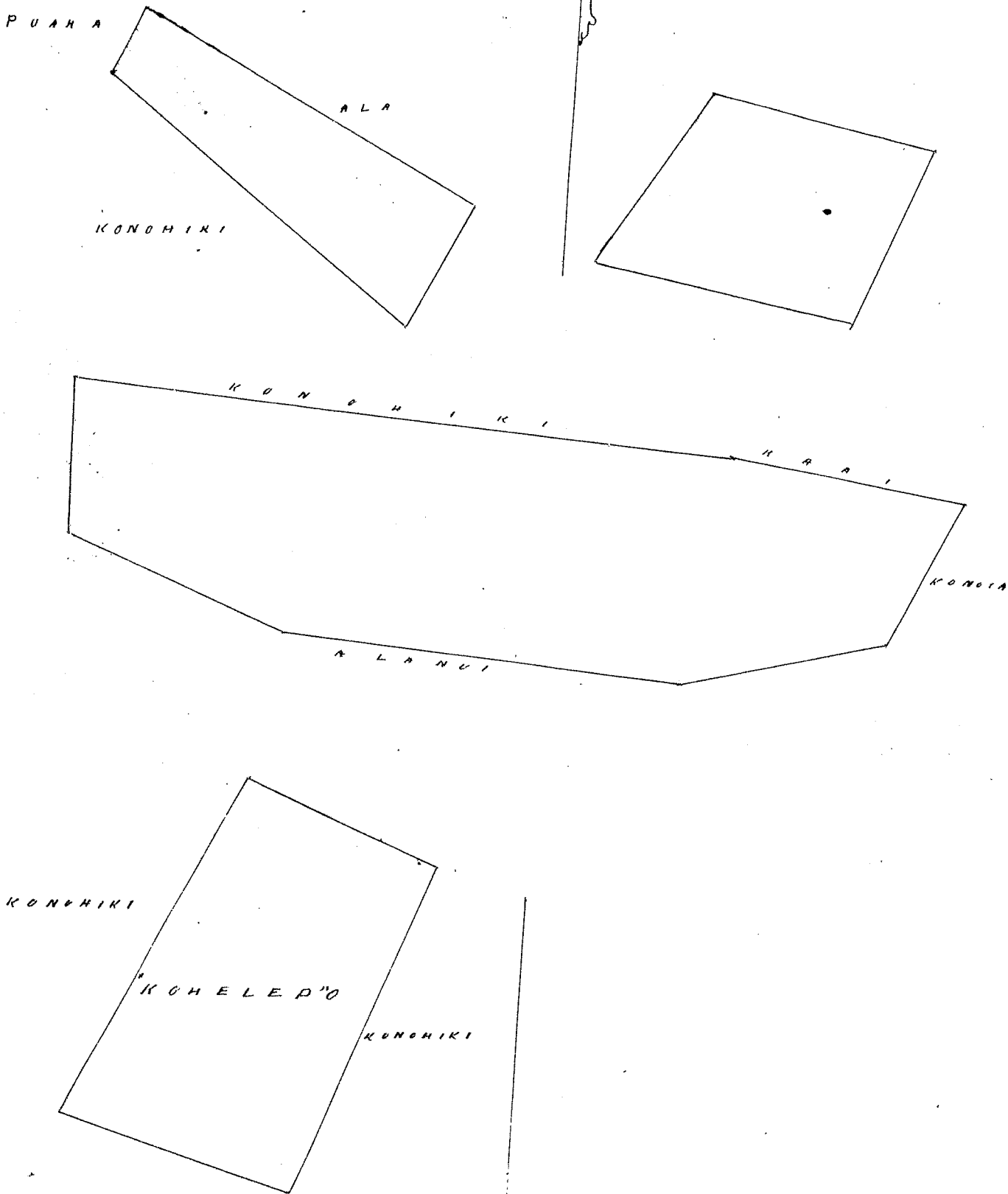

Wm Pau Lea \$ 12

W. L. Lee

S. M. Robertson

J. Hekaulahao

C. H. Smith

Honolulu 5 Aug 1852

Keolu 8652 Kahahele

Omaopio 10 Kula & Maui

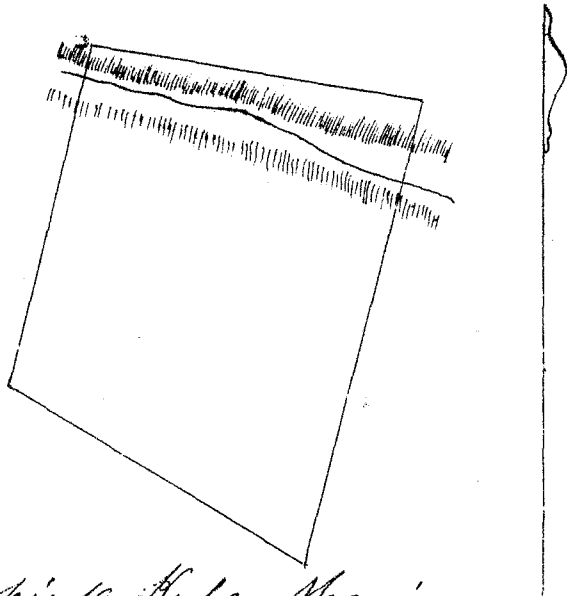

Kahahele ma Kahahele Omaopio 10 Kula & Maui
Kula & hoomaka ana ma ke Kahi Aha a e holo ke 77 ki 700 pautu ma ke Konoheki ke 17 1/2 ki 910 pautu
& pili ana ma Konoheki ke 55 ki 720 pautu ma ke Konoheki ke 17 1/2 ki 730 pautu ma ke Konoheki i ke
Kahi mua 6 Eka.

6. Jan 1852

A F Turner
Luna ana aina

Wm Pau Loa \$ 7

W. L. Lee
G. M. Robertson
J. K. Kaulahao
J. H. Smith

Honolulu 5 Aug 1852

Keolu 3759 Kaili (558175 ma mua)

Omaopio 6 Kula Maui

KONOHIKI

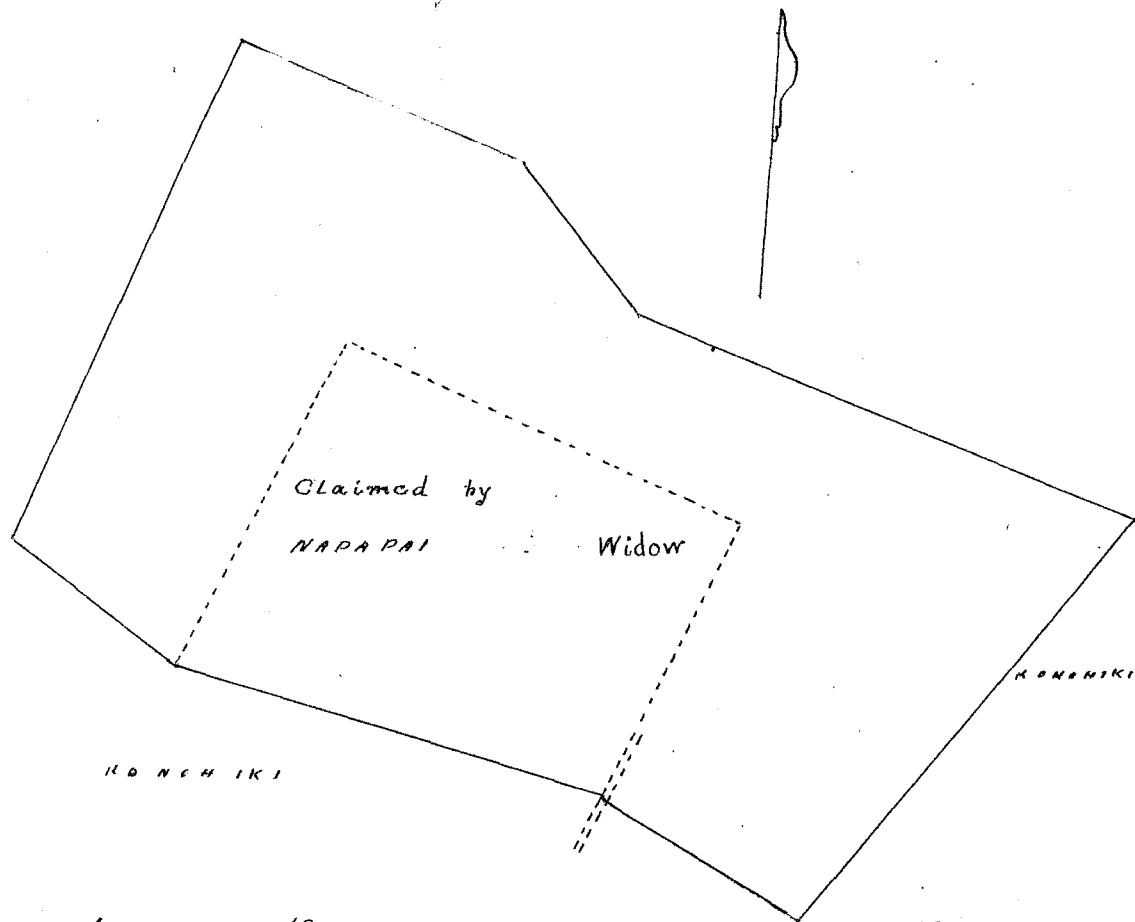

Kaili ma Kuapohaku & Hamakapouli Omaopio 6 Kula & Maui
Aina Kula, & hoomaka ana ma ke Kahi Aha a e holo ana ke 60 ke 484 pautu & pili ana i
ke Konoheki ke 7 1/2 ke 950 pautu & pili ana i ke Konoheki ke 55 ke 427 pautu & pili ana i ke Konoheki
ke 22 1/2 ke 1165 pautu & pili ana ma Konoheki ke 70 ke 650 pautu & pili ana ma Konoheki ke 37
ke 400 pautu & pili ana i ke Konoheki ke 69 ke 1130 pautu & pili ana i ke Konoheki ke 38 ke 1108
pautu & pili ana i ke Konoheki i ke Kahi mua 2 1/2 Eka

7 Jan 1852

A F Turner
Luna ana aina

See Page 558 of 7

Wm Pau Loa \$ 15.

p. 558. Vol 7.

Honolulu 5 Aug 1852

Heleu 3720 ^B Kaumaiwa

Lanai

Ke ana ana ana i kekahi Apana aina. Kaumaiwa ma ke Ahupuaa "Maunali" Moku-puni Lanai

Pauku aina Hale Chomaka ana i ke kahi Akau ma kahi i pili ai ia Kuaa a me Kahawai, a e holo ana, He 42' He 1.41 Kaulahas ma Kahawai, He 57 1/2' He 0.52 Kaulahas ma Kawaiti He 36' He 1.25 Kaulahas ma Kalele aumoku, A 38' He 0.37 Kaulahas ma Kalele aumoku, a hiki i kahi i hoomaka i O Hona ili 9 Roda

L. S. Wa.
Mea ana aina

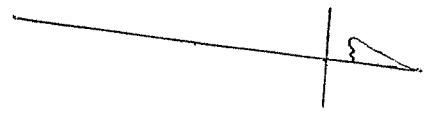
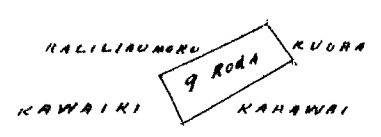

Compared Copy J. H. Smith, Lev. B. Se. not written by me J. H. Smith

Uku Pau Loa \$ 4.00

W. L. Lee
G. M. Robertson
J. H. Smith
J. Kekaulahas

Honolulu 12 Aug 1852

Heleu 6844 & 10027 Kalimu Maunali Lanai.

Ke ana ana i kekahi Apana aina. Kalimu ma ke Ahupuaa. Maunali Moku-puni Lanai

Pauku aina Hale Chomaka ana ma ke kahi Akau, keia a e holo aku, He 34 1/2' He 1.33 Kaulahas ma ke Kauhiki He 32' He 0.54 Kaulahas He 51' He 1.58 Kaulahas ma ke Kauhiki He 43' He 0.89 Kaulahas ma ke Kauhiki He 39 1/2' He 0.82 Kaulahas ma ke Kauhiki He 52' He 0.93 Kaulahas ma ke Kalawaia A 76' He 1.59 Kaulahas ma ke Kalawaia He 44 1/4' He 1.04 Kaulahas ma ke Kalawaia Akau 2.88 Kaulahas ma ke Kahawai He 22 1/2' He 0.35 Kaulahas ma ke Kahawai a hiki i kahi i hoomaka ai O Hona ili 2 Roda 14 Roda

L. S. Wa.
Mea ana aina.

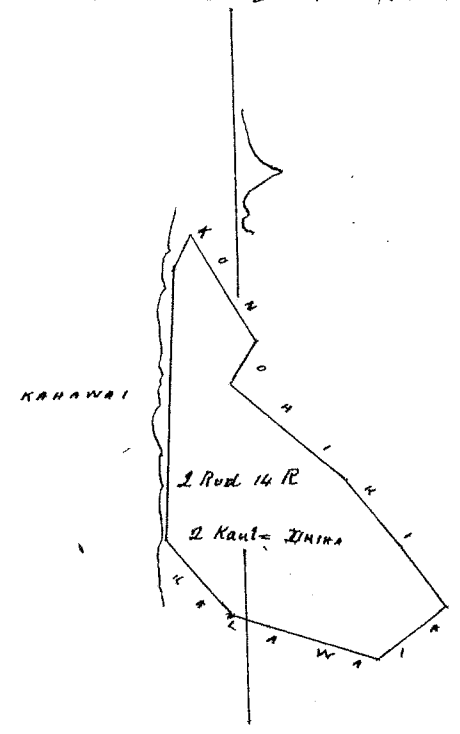

Nana Awao 683 Vol. 5.

Uku Pau Loa \$ 4

W. L. Lee
G. M. Robertson
J. H. Smith
J. Kekaulahas

Honolulu 12 Aug 1852

Heleu 8627 Kauhikape "Kaa" Lanai

Ke ana ana ana i kekahi mau Apana aina. Kauhikape ma ke Ahupuaa. Kaa Moku-puni Lanai.

E lua mau Apana

Apana 1 Wahi Kula Wahi Chomaka ana ma ke kahi Kema. keia a e holo aku, A 47' He 1 Kaulahas ma Kauhiki A 45' He 2.07 Kaulahas ma Kauhiki He 48 1/2' He 0.76 Kaulahas ma Kauhiki He 43 1/2' He 2.39 Kaulahas ma Kauhiki a hiki i kahi i hoomaka ai O Hona ili 37 Roda

Apana 2 Pahale & aina Kula wahi Chomaka ana ma ke kahi Kema Kauhikape a e holo ana He 48 1/2' He 3.52 Kaulahas ma Kauhiki A 45' He 17.25 Kaulahas ma Kauhiki A 63' He 6.14 Kaulahas ma Kauhiki He 46 1/2' He 15.72 Kaulahas ma Kauhiki

a hiki i kahi i hoomaka ai O Kona ili 7 Eka 3 Ruda 14 Roda

L. S. Wa,
Mea ana aina

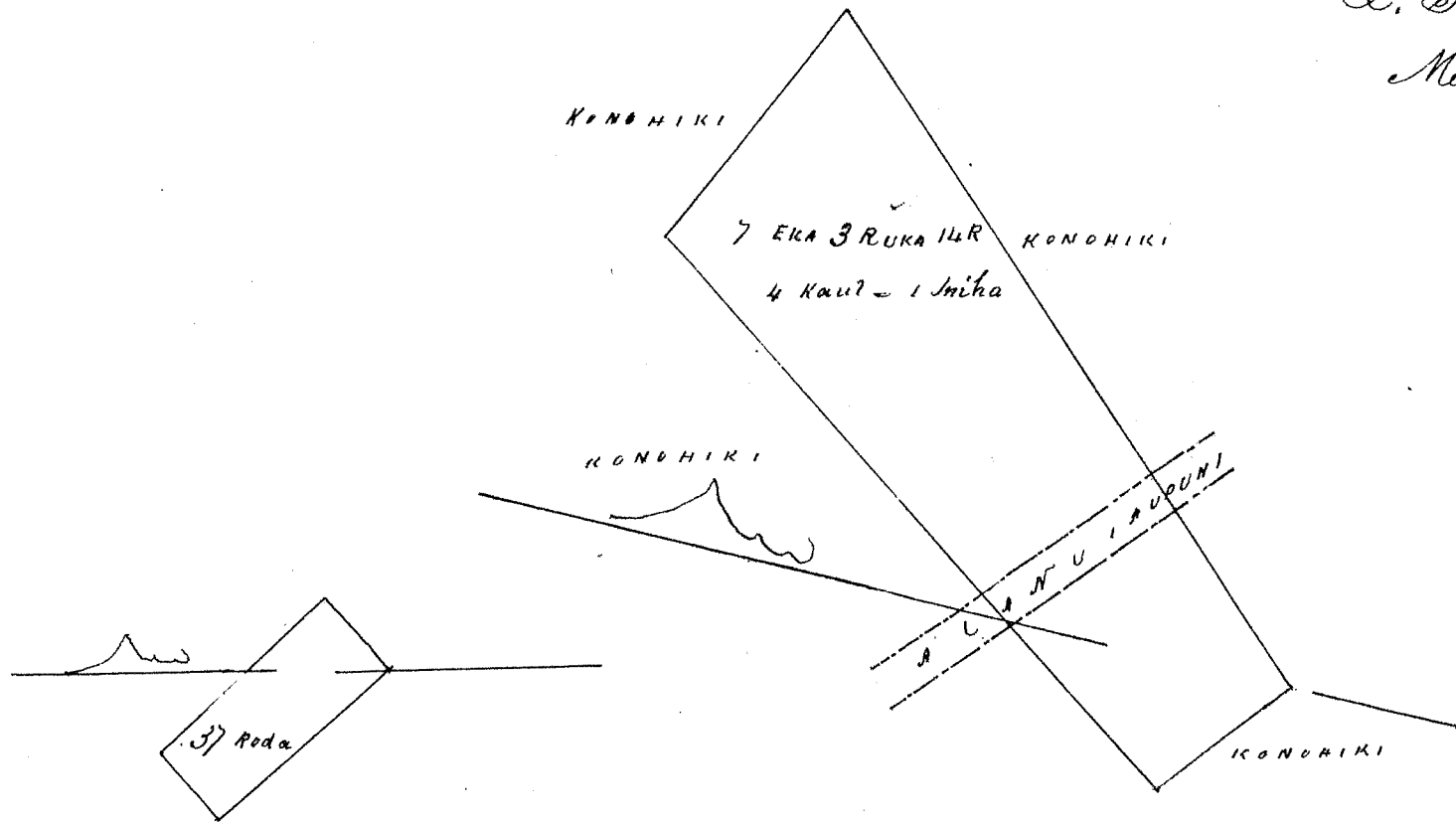

Uku Pau Loa # 6

W. L. Lee
G. M. Robertson
J. Kekaulahao
J. H. Smith

Honolulu 12 Aug 1852

Heleka 6825 Kalamiwahine

Kaunohu Lanai

Ke ana ana ana i kahi mau Apana aina. Kalamiwahine ma ke Ahupuaa. Kaunohu Motupuni.
Lanai E lua mau Apana;

Apana 1 Pahale E hoomaka ana ma ke kahi e pili ai i ke Kahakai ma ke Halekula a holo aku, He 41° He 355 Kaulahao ma ke Halekula, He $52\frac{1}{2}^\circ$ He 388 Kaulahao ma ke Kama A $39\frac{3}{4}^\circ$ He 326 Kaulahao ma Konohiki. A 48° He 382 Kaulahao ma ke Kahakai a hiki i kahi i hoomaka ai O Kona ili 1 Eka, 1 Ruda 11 Roda,

Apana 2 Pautu aina Kula E hoomaka ana ma ke kahi Akai ma Kahakai a holo ana He $38\frac{1}{2}^\circ$ He 514 Kaulahao ma ke Konohiki. He 49° He 1563 Kaulahao ma ke Konohiki A 38° He 577 Kaulahao ma ke Konohiki a hiki i Kahakai A 52° He 1565 Kaulahao ma Kahakai a hiki i kahi i hoomaka ai O Kona ili 8 Eka 2 Ruda 27 Roda

L. S. Wa
Mea ana aina

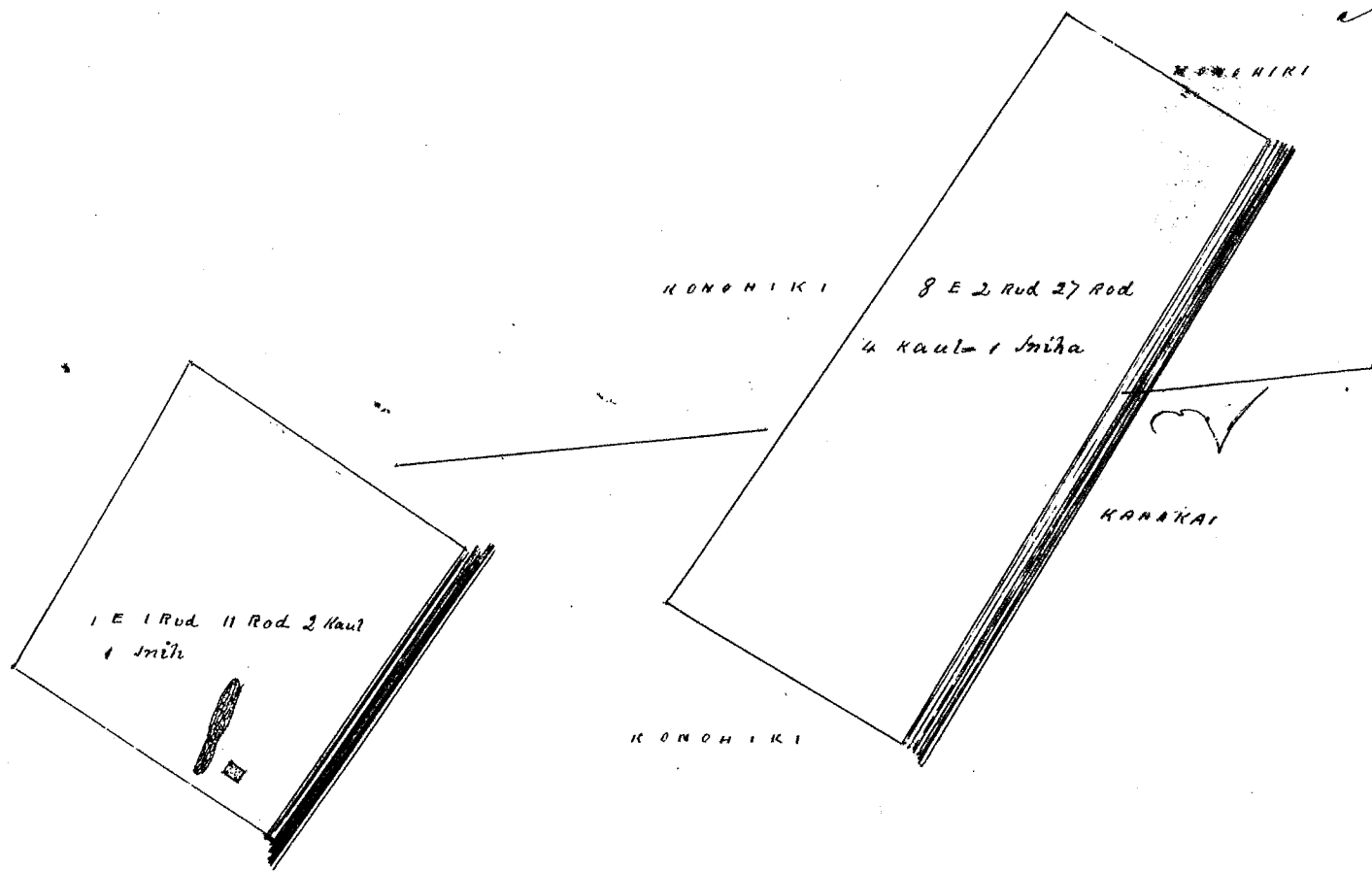

Uku Pau Loa # 7

W. L. Lee
G. M. Robertson
J. Kekaulahao
J. H. Smith

Honolulu 12 Aug 1852

Hoenu 6833 S. Waimalei

Maunalei Lanai

Ke ana ana i kekahi mau Apana aina o S. Waimalei ma ke Ahupuaa o "Maunalei" ana ma "Hakunui" ma ka Mokupuni o Lanai E hoo maan Apana,

Apana 1 Pahale ma Maunalei E hoomaka ana ma ke Piki Nihina ma kahi i pili ai ma Kahakai a holo aku, Ke 42° No 5,35 Kaulahas ma ke Kalawaia AK 48° No 5,71 Kaulahas ma ka Halekula A 42° No 5,06 Kaulahas ma ke Honohiki Ke 50 1/2° No 5,75 Kaulahas ma Kahakai a hiki i kahi i hoomaka ai O kua ili 2 Eka 3 Ruda 3 Roda

Apana 2 Kula onahi ma Hakunui E hoomaka ana ma ke Piki Komohana ma kahi i pili ai i ke Honohiki a holo aku, Ke 67 1/2° No 5,93 Kaulahas ma ke Honohiki AK 65° No 8,30 Kaulahas ma ke Honohiki A 29 1/2° No 4,53 Kaulahas ma ke Honohiki Ke 74 3/4° No 8,16 Kaulahas ma ke Honohiki a hiki ma kahi i hoomaka ai O kua ili 3 Eka 2 Ruda 25 Roda

Apana 3 Paikuu Aiaa Kalo i "Maunalei" E hoomaka ana ma ke Piki Akaa Komohana. Keia ma Kahawai a holo aku, Ke 18° No 1,96 Kaulahas ma Kahawai AK 68 1/2° No 9,52 Kaulahas ma Honohiki A 18° No 1,96 Kaulahas ma ka pali, Ke 68 1/2° No 9,52 Kaulahas ma ke Honohiki a hiki i kahi i hoomaka ai O kua ili 16 Roda

L. S. Ua
Ma ana aina

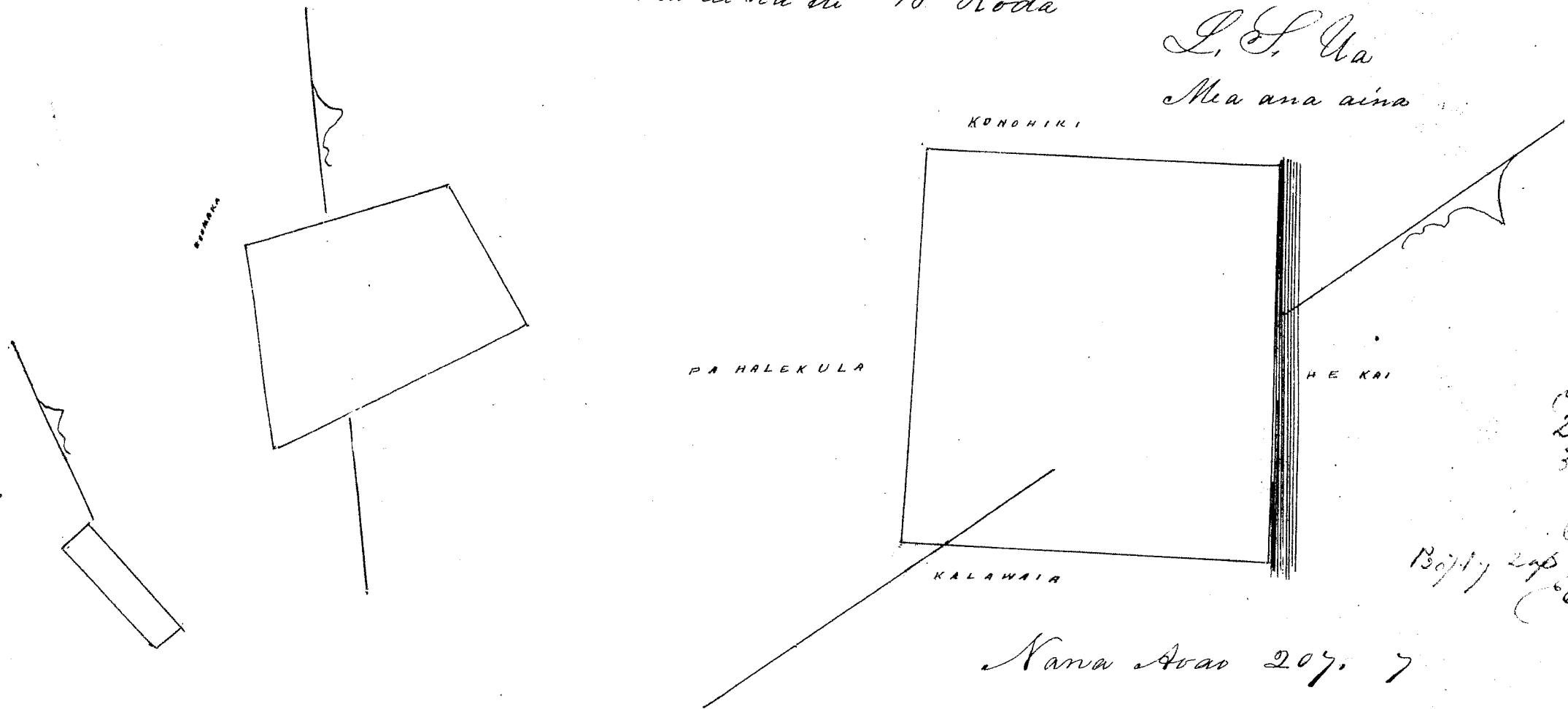

Wku Pau Loa #3.
W. L. Lee
G. M. Robertson
J. Kekaulahas
J. H. Smith

Honolulu 12 Aug 1852

Hoenu 6838 Apiki

Maunalei Lanai

Ke ana ana i kekahi Apana aina o Apiki ma ka ili o Kaacali Ahupuaa o Maunalei Mokupuni o Lanai, Paikuu aina Kalo

E hoomaka ana ma ke Piki Komohana. Keia aina ma Kahawai a holo aku, Ke 31 1/2° No 3,74 Kaulahas ma Kahawai, AK 88 1/2° No 9,69 Kaulahas ma Honohiki A 26° No 2,11 Kaulahas ma ka pali A 40° No 2,00 Kaulahas ma ka pali, Ke 66° No 0,54 Kaulahas ma ka pali a hiki i kahi i hoomaka ai, O kua ili 1 Ruda 4 Roda,

L. S. Ua
Ma ana aina

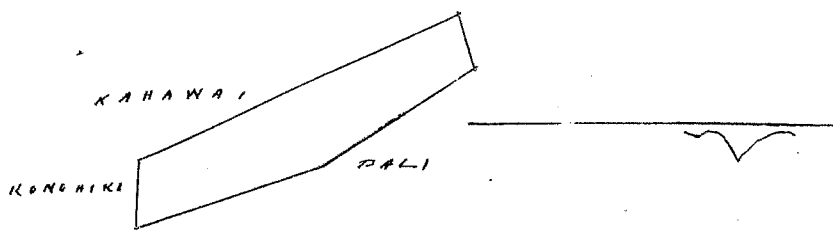

Nana awao 685 v. 5. Uu² Boote.

Wku Pau Loa #2
W. L. Lee
G. M. Robertson
J. Kekaulahas
J. H. Smith

Honolulu 12 Aug 1852

Heleu 9000 Kawaiki

Maunali Lanai

Ke ana ana i kekahi mau Apana aina o Kawaiki ma ke Ahupuaa o Maunali Moku o Lanai, E lua mau Apana.

Apana 1. Pahale, E hoomaka ana i ke Kiki Akau, o keia ma Kahakai a holo aku, He 40° He 4 Haulahas ma ke Honohiki He 50° He 5, 83 Haulahas ma ke Honohiki He 4, He 4 Haulahas ma ke Honohiki He 50° He 5, 83 Haulahas, ma Kahakai a hiki i kahi i hoomaka ai O Kona i 2 Eka 1 Ruda 13 Roda.

Apana 2. Pauhina Kalo E hoomaka ana ma ke Kiki Akau, o keia ma Kahi i pili aia Kaawae aina a me Kahawai, a i holo aku He 65° He 112 Haulahas ma ke Kaawaeaina He 4 1/2 He 105 Haulahas ma ke Pali He 28° He 127 Haulahas ma ke Malulu He 65° He 108 Haulahas ma ke Kahawai A 3 1/2 He 194 Haulahas ma ke Kahawai a hiki i kahi i hoomaka ai O Kona i 17 Roda

L. S. Ua
Mea ana aina

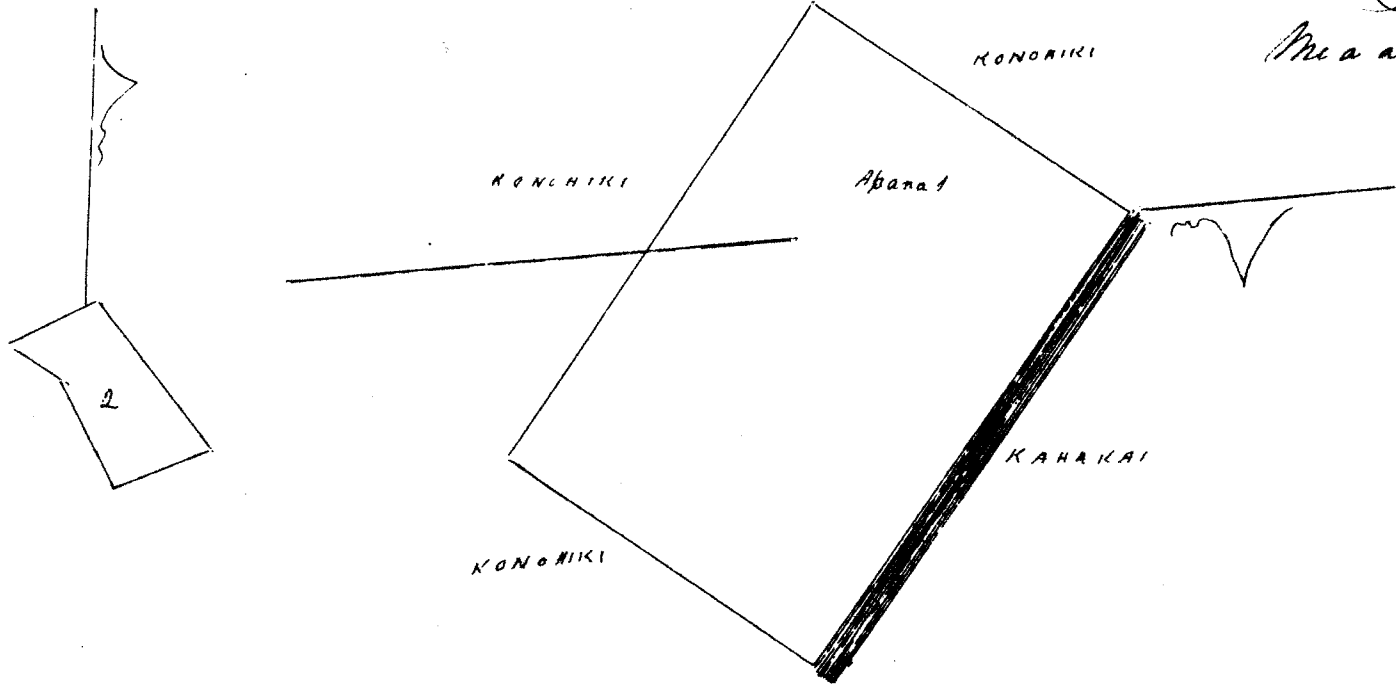

Wai Pau Loa # 5

W. L. Lee
G. M. Robertson
J. Kekaulahas
J. K. Smith

Honolulu 12 Aug 1852

Heleu 6824 & 10030 Kapuuhi

Kaunolu Lanai

Ke ana ana i kekahi Apana aina o Kapuuhi ma ke Ahupuaa o "Kaunolu" o Lanai Pauhina Kalo E hoomaka ana i ke Honohiki a holo aku, He 38° He 1298 Haulahas ma ke Honohiki He 64° He 650 Haulahas ma ke Kalaniwahine A 33° He 1298 Haulahas ma ke Kalaniwahine A 65° He 540 Haulahas ma ke Honohiki a hiki i kahi i hoomaka ai O Kona i 2 Eka 2 Ruda 4 Roda.

L. S. Ua.
Mea ana aina.

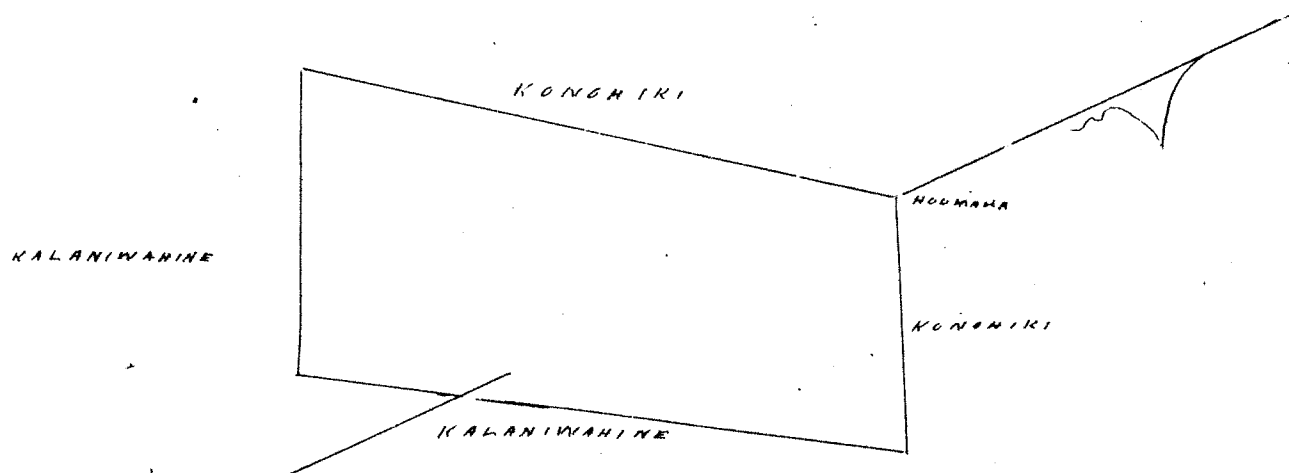

Wai Pau Loa # 6

W. L. Lee
G. M. Robertson
J. Kekaulahas
J. K. Smith

Honolulu 12, Aug 1852

Hele 6840 Kauhā (6840)

Maunalei Lanai

Ke ana ana i kekahi Apuna aina o Kauhā ma ke Ahupuaa 'Maunalei' Mokupuni. Lanai
Pauku aina Kalo i loko, Kauhā, E hōmaka ana ma ke Pili Kōmohana. Keia ma Kahi i
pili ai ia Kauhā ma Ke Kauhā ma Ke Kauhā ma Ke Kauhā ma Ke Kauhā ma Ke Kauhā
No 0.37 Kauhā ma Ke Kauhā ma Ke Kauhā ma Ke Kauhā ma Ke Kauhā ma Ke Kauhā
No 42 1/2 No 0.52 Kauhā a hiki i Kauhā Kahi i hōmaka ai Oka i 1 Ruda 2 Ruda

L. S. Wa
Ma ana aina

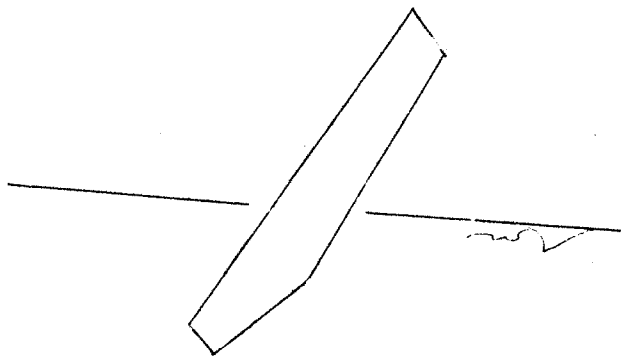

Nano Apuna 3. Acar 682 Vol. 5.

W. L. Lee

G. M. Robertson

J. K. Kaulahao

J. H. Smith

Honolulu 12 Aug 1852

Hele 8557 Kauhā (8557)

Maunalei Lanai

Ke ana ana i kekahi Apuna aina. Kauhā ma Ke Kahi. Kahi Ahupuaa. Maunalei Mokupuni
Lanai Pauku aina Kalo
E hōmaka ma ke Pili Kōmohana. Keia ma Kahi i pili ai ia Kalo ma Ke Pili a hōmaka
A 75° No 0.59 Kauhā ma Ke Kalo ma Ke Kalo ma Ke Kalo ma Ke Kalo ma Ke Kalo
Kauhā ma Ke Pili A 43° No 1.70 Kauhā ma Ke Kalo ma Ke Kalo ma Ke Kalo
ma Ke Kalo a hiki i Kahi i hōmaka ai Oka i 1 Ruda 3 Ruda

L. S. Wa
Ma ana aina.

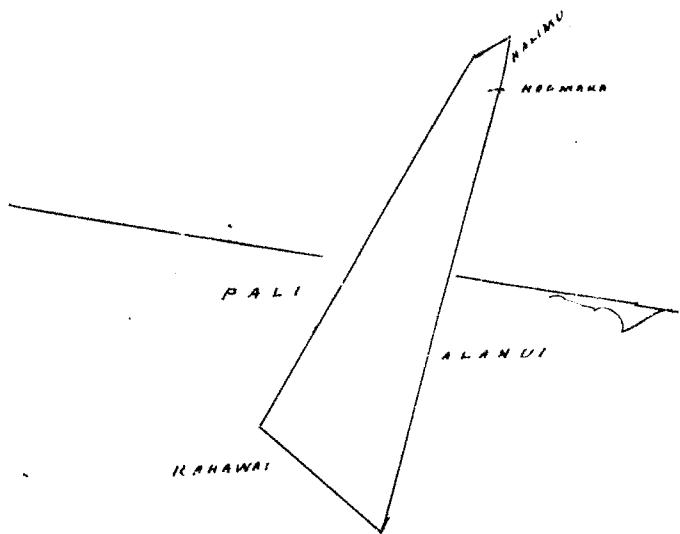

Nano Apuna 2. Acar 681 Vol. 5.

W. L. Lee

G. M. Robertson

J. K. Kaulahao

J. H. Smith

Honolulu 12 Aug 1852

Hele 8588 Kalo (8588)

Maunalei Lanai

Ke ana ana i kekahi Apuna aina. Kalo ma Ke Ahupuaa. Maunalei Mokupuni. Lanai
Pauku aina Kalo aia i loko, Ke awawa, E hōmaka ma ke Pili Kōmohana. Keia ma Kahi i
ma Ke Kalo ma Ke Kalo ma Ke Kalo ma Ke Kalo ma Ke Kalo ma Ke Kalo
No 0.92 Kauhā ma Ke Kalo ma Ke Kalo ma Ke Kalo ma Ke Kalo ma Ke Kalo
ma Ke Kalo ma Ke Kalo ma Ke Kalo ma Ke Kalo ma Ke Kalo ma Ke Kalo
ma Ke Kalo ma Ke Kalo ma Ke Kalo ma Ke Kalo ma Ke Kalo ma Ke Kalo

L. S. Wa
Ma ana aina.

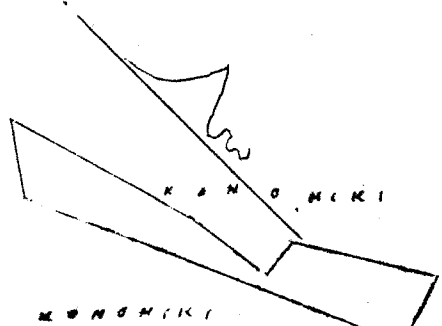

Uku Pau Loa \$ 2.00

W. L. Lee
G. M. Robertson
J. Kekaulaha
J. H. Smith

Honolulu 12 Aug 1852

Heleu 10816 Pohano

Hokunui Lanai

Ke ana ana i kekahi Apana aina o Pohano ma ka ili o "Malau" ma ke Ahupuaa o "Hokunui" Moku o Lanai

Ke Kula mahi, E hoomaka ana ma ke Pili Akau Nihina o keia ma ka hiki i pili ai ia i Waimalu a ma Amo ike a e holo ana, Ak 77' Ni 840 Kaulahas ma ke Honohiki Ni 11' Ni 347 Kaulahas ma ke Honohiki Ak 79 1/2' Ni 646 Kaulahas ma ke Honohiki Ni 56' Ni 164 Kaulahas ma ke Honohiki Ak 27' Ni 335 Kaulahas ma ke Honohiki A 53 1/2' Ni 39 Kaulahas ma ke Honohiki Akau 0,93 Kaulahas ma ke Honohiki A 85' Ni 284 Kaulahas ma ke Honohiki A 8 1/2' Ni 2,86 Kaulahas ma ke "Waimalu" a hiki i ka hiki i hoomaka ai O kona ili 3 Peka 15 Roda

J. S. Wa

Ma ana aina

Nana Awa 680 Vol. 5.

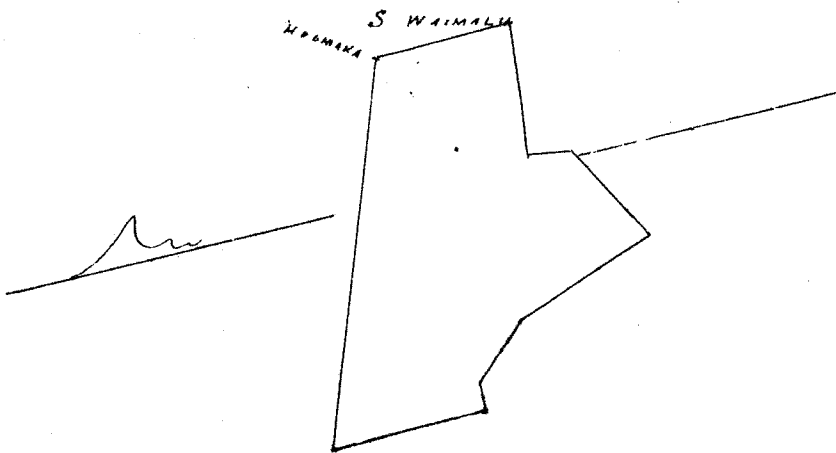

Uku Pau Loa \$ 6

W. L. Lee
G. M. Robertson
J. Kekaulaha
J. H. Smith

Honolulu 12 Aug 1852

Heleu 6837 Matulu

Maunalei Lanai

Nana Awa 208. 7

Ke ana ana i kekahi Apana aina o Matulu ma ka ili o "Maunalei" Ahupuaa o "Maunalei" Moku o Lanai

Puuhua aina Hale E hoomaka ana ma ke Pili Komohana o keia ma ka hiki i pili ai i ke Kawaaiki a ma ka pali a e holo ana, A 65' Ni 468 Kaulahas ma ke Kawaaiki Ni 46 1/2' Ni 0,34 Kaulahas ma ke Kawaaiki Ni 13' Ni 144 Kaulahas ma ke Kawaaiki Ni 86 1/2' Ni 0,60 Kaulahas ma ke Kawaaiki A 35 1/2' Ni 453 Kaulahas ma ka Pali a hiki i ka hiki i hoomaka ai O kona ili 24 Roda

J. S. Wa

Ma ana aina

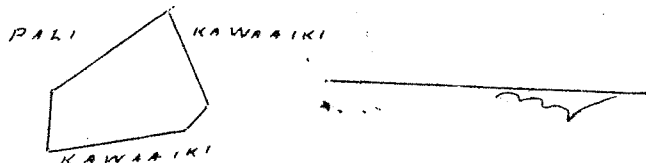

Uku Pau Loa \$ 4

W. L. Lee
G. M. Robertson
J. Kekaulaha
J. H. Smith

Honolulu 12 Aug 1852

Heleu 6841 Awa

Maunalei Lanai

Ke ana ana i ke Pili Apana aina o Awa ma ka ili o "Maunalei" ma ke Ahupuaa o "Maunalei" Moku o Lanai (Ma mahe o Awa) o ka wahine ana ma hoolina Puuhua aina Hale

E hoomaka ana ma ke Pili Akau o keia a e holo ana Ni 45' Ni 0,65 Kaulahas ma ke Honohiki Ni 15' Ni 327 Kaulahas ma ke Honohiki Ak 45' Ni 0,65 Kaulahas ma ke Honohiki Ak 45' Ni 2,27 Kaulahas ma ke Honohiki a hiki i ka hiki i hoomaka ai O kona ili 11 Roda

J. S. Wa

Ma ana

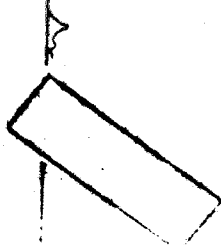

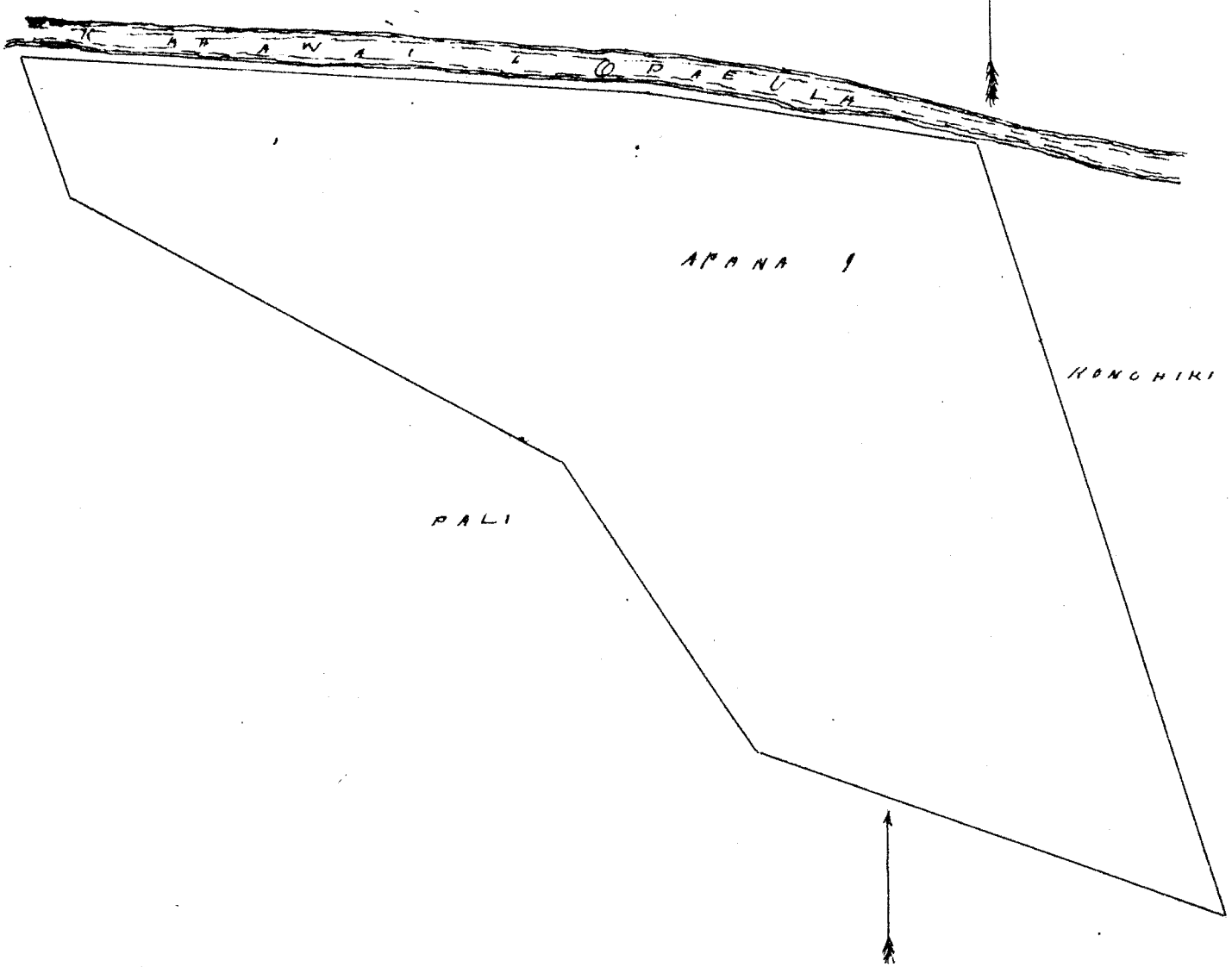

Wai Pau Loa # 6.
 W. L. Lee
 G. M. Robertson
 J. Kekaualaha
 J. H. Smith

Honolulu 14 Aug 1852

Kolu 7425 Kawaia

Kawailoa Waialua Oahu

Ke Kawaia mau aina ma Kawailoa Waialua i Kona pahale ma Kahakai o Anohulu, E hoo-
 aka ma ke Kahi Ke A ma Konoiki Kolo A 67 hi 136 ma Kahakai Kolo Ke 23 hi 178 ma ke Konoiki
 Kolo Ke 68 1/2 hi 156 ma ke Konoiki Kolo A 12 1/2 hi 190 ma ke Konoiki i ke Kahi mua Area 35 Aka

Apana 2 ma Oe Kawailoa Kahi Koomaka ma ke aoso Ke o ke Laanui pahale
 i lua 76 paau, mai ke Kahi Ke A. Kolo Ke 86 hi 172 ma Kawaia Kolo Ke 86 hi 260 ma
 ke Luahiwa Kolo Ke 89, Ke 0,90 ma ke Kakaaua, Ke 19 hi 2,00 ma ke Keliwawai ole
 A 87 1/2 hi 5,70 ma ke Mokuu A 3, Ke 2,35 ma ke Mokuu o Laanui i ke Kahi mua
 Area 1,32 Aka,

Ma ke Konoiki i Keia Kuleana,
 Waialua July 20, 1852

J. S. Emerson
 Ma ana

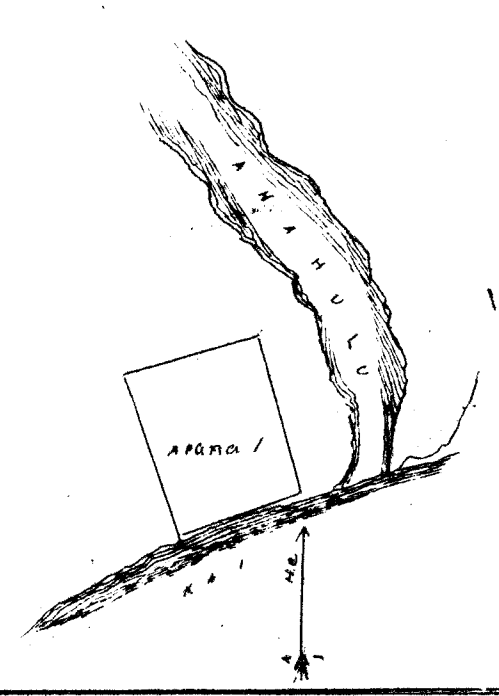
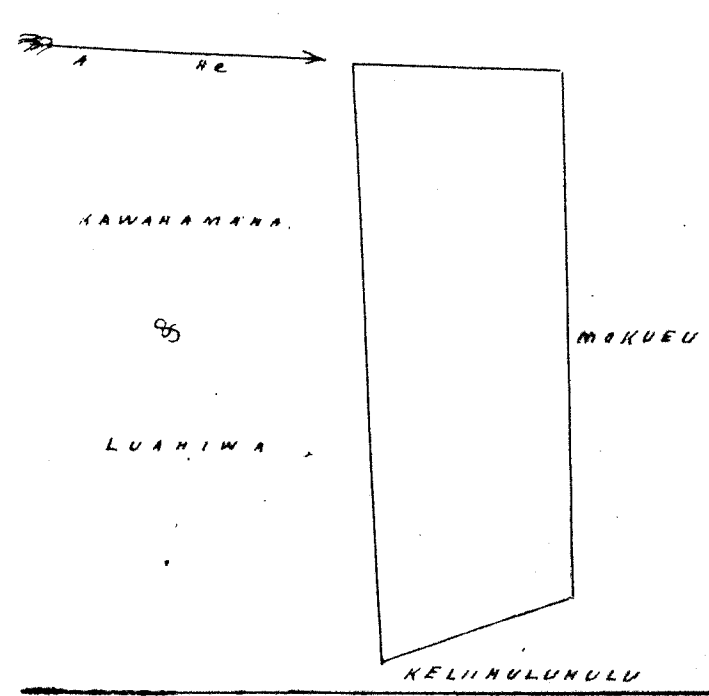

Wai Pau Loa # 5
 W. L. Lee
 G. M. Robertson
 J. H. Smith
 J. Kekaualaha

Honolulu 14 Aug 1852

Ko Hokuaulani aina ma Kawailoa,

Apana 1. Kapaia Hanuawai Homaka ma Ke Kahawai Kiki Komohana Akae
 . Ke Emerson pa aka, holo AK, 85 3/4 Ni 2,27 ma Ke ana hulu holo Ke 6 1/2 Ni 56 ma Ke
 Nauahi holo Ke 87 Ni 146 ma Ke Nauahi holo Ke 4 1/2 Ni 112 ma Ke Nauahi
 holo Komohana Kupono 153 ma Ke Nauahi holo Ke 5 Ni 145 ma Ke Kuroka holo
 AK, 89 Ni 445 ma Ke paali holo AK 8 1/2 Ni 340 ma Ke pa. Emerson i Ke Kiki
 mua, Area 1, 21 Eka,

Apana 2, Homaka ma Ke Anahulu, Kiki Komohana Akae o Ke
 Nauahi aina holo AK 60 Ni 2,93 ma Ke Anahulu, holo AK 44 Ni 120 ma Ke Anahulu
 holo Ke 7 Ni 5,73 ma Ke Kapunawai ona, holo AK 79 1/2 Ni 2,97 ma Ke Kuroka
 holo AK 5 Ni 2,82 ma Ke Nauahi i Ke Kiki mua Area 1, 32 Eka,

Apana 3. Kona Kahuahala ma Kawailoa, Ka, Homaka ma Ke Laanui
 pahale Kiki Komohana Akae, holo holo 65 Ni 1,75 ma Ke pa aina holo Ke 16
 Ni 233, ma Ke Kikaua, holo AK 63 Ni 2,33 ma Ke ala nukuu holo AK 28 Ni
 2,28 ma Ke Laanui i Ke Kiki mua, Area 0,46 o Ke Eka,

Apana 4 Homaka ma Ke huina o ma ala, Kiki Kikina Kona o
 Laanui, holo holo 60 Ni 3,60 ma Ke ala nukuu, holo Ke 27 Ni 2,50 ma Ke
 aina Pahao AK 64 Ni 1,57 ma Ke Kahuahala, holo AK 23 Ni 481 ma Ke
 Kahuahala, holo AK 58 Ni 205 ma Ke Kahuahala AK 30 Ni 62, ma Ke ala
 i Ke Kiki mua, Area 0,51 o Ke Eka,

1.21
1.32
46
50
45
39
4.26

Apana 5. Ma Kai o Makole, Ke Loi Kawailoa, Homaka ma Ke
 Kiki Kikina Akae, Kahuahala ma Ke Kalamana holo AK 71 1/2 Ni 2,29
 ma Ke Kalamana holo Ke 31 Ni 1,93 ma Ke auwai o Gulick, holo Ke 70 Ni 158
 ma Ke Kahuahala holo Ke 19 Ni 0,26 ma Ke Kahuahala, Ke 63 1/2 Ni 0,88
 ma Ke Kahuahala holo Ke 73 Ni 0,47 ma Ke Kahuahala, holo AK 19 1/2 Ni 2,52
 ma Ke Kahuahala, i Ke Kiki mua Area 0,45 Eka Eka

Apana 6, Kona Apana Kala ma Ke Kona Homaka ma Ke Kiki
 Kikina Kona o Ke Kapule ma Ke Laanui Loi, holo holo 21 Ni 215 Kaul
 ma Ke Kaula, holo Ke 7 1/2 Ni 1,50 Kaul ma Ke Pilipi holo AK 21 Ni 210
 ma Ke Lohe holo AK 77 1/2 Ni 149 Kaul ma Ke Kapule i Ke Kiki mua
 Area 0 31 o Ke Eka

Ua kuhikahi mai Ke Kona Kiki i Keia mau aina a pau a wa
 ae i Ke lilo ana ia ia

Waiakua July 29, 1852

J. S. Emerson
 Mua ana

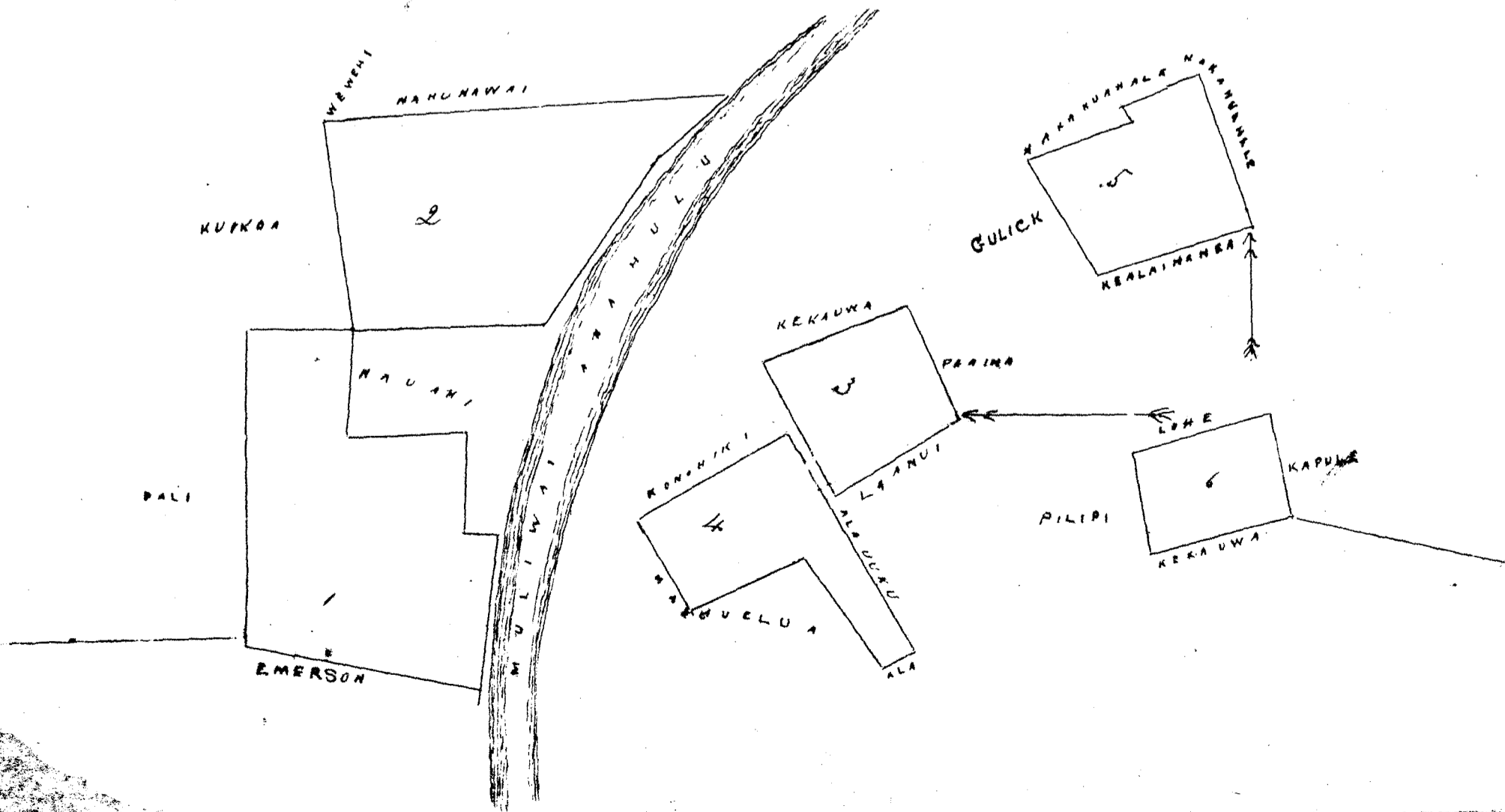

W. L. L.
J. Kekaulahao
M. Perillo
G. M. Robertson

Honolulu 14 Aug 1852

Hele 7342 Koukooa L. () Hawaiiwa Waialua Oahu

Ko Koukooa Kuleana ma Hawaiiwa Waialua

Apana 1 Kahi Kapu ma Uka o Anahulu Hoona ma ke Koinike Kahi Komohana, ma ke
Kahawai, Holo Ak, 39 1/2 Hiki 1,23 Haul ma ke Kaiariko Holo Ak 26 1/2 Hom 3,50 Haul, ma ke Koini-
kiko me Lapan, Holo Ak 85° Hom 2,80 Haul ma ka pali, Holo Ak 74° Ho 259 ma ka pali, Holo
Ak 58 1/2 Ho 7,00 ma ke Kahawai i ke Kahi mua, Area 1,47 Eka.

Apana 2, Kookia Hoona ma ka papohaku o ma ke Kahawai, Holo Ak 24° Ho 1,50 ma ke
Kahawai, Holo Ak 24° Ho 1,50 ma ke Kahawai, Holo Ak 75 1/2 Ho 7,07 ma ka pali, Ho 39 1/2 Hiki 2,62 ma ke
Mokua, Holo 32 1/2 Hiki 2,62 ma ke Hoona, Ak 46° Hiki 6,30 ma Kahawai i ke Kahi mua Area 2 Eka

Apana 3, ma Kookia Hoona ma ke Kahi Komohana Akau o ke Koinike Lina ma ke
Akau, ka Auwai Holo Hema 7° Hiki 1,50 Haul ma ka auwai Holo Ak 1 1/2 Ho 4,90 Haul, ma ke
Koinike, Holo Ak 78° Hom 3,75 Haul ma ka pali, Holo Hom 9 3/4 Ho 385 Haul ma ke Nana,
Holo Ak 63 1/2 Hiki 3,50 Haul, ma ka Auwai i ke Kahi mua Area 1,89 Eka (Aina Kalo)

Apana 4, Kapua Kiuwa Hoona ma ke Kookala Kahi Komohana Hema ma ke Kahawai Holo
Ak 41 1/2 Hiki 3,22 Haul, ma ke Kookala, Ak 10° Hiki 1,20 Haul, ma ke Kookala Holo Ak 30° Hiki 2,00
Haul ma ke Koinike Holo Ak 40° Hom 1,70 Haul, ma ka pali, Holo Hom 25 Hom 3,80 Haul ma ke
Maia Holo Hom 53° Ho 2,89 Haul ma ke Maia Holo 53 1/2 Ho 2,38 Haul ma ke Kahawai i ke Kahi
mua Area 1,15 Eka

1.47
2.89
1.15
1.69
3.22
2.89
97.36
Panda 97
5
7342

Apana 5 ma Kauhawai Hawaiiwa Kai, Hoona ma ke Kookaulani Kahi Komohana
Hema, ma ka Pali, Holo Ak 5° Hom 1,45 Haul ma ke Kookaulani, Holo Hom 79 1/2 Ho 2,77 Haul ma
ma ke Kookaulani, Ak 89° Ho 2,46 Haul, ma ke Koinike o Kahuna, Holo Ak 77 1/2 Ho 1,19 Haul
ma ke Pahi, Holo Hom 8 1/2 Hiki 1, Haul, ma ka pa aina Holo Ak 89° Hiki 6,35 Haul, ma ka
pali i ke Kahi mua Area 0,69 o ka Eka,

Apana 6, Hoona ma ke Kahi Komohana Hema, Kona Apana 5, Holo Hom 83°
Ho 5,67 Haul, ma ke Koinike Holo Ak 0 1/2 Hiki 3,92 Haul ma ke Pahu, Holo Ak 13° Ho 0,87
Haul, ma ke Kahiawa Holo Ak 23 1/2 Hiki 1,44 Haul ma ke Loha Holo Ak 43 Hiki 1,28 Haul,
ma ke Loha, Holo Hom 32 1/2 Hiki 1,33, Haul, ma ke Loha o Nana, Holo Hom 56 1/2 Hiki 1,36
ma ke Nana, Holo Hom 27° Hiki 0,98 Haul ma ke Nana, Holo Ak 79 1/2 Hiki 0,80 Haul ma
ke Nana, Holo Hom 8 1/2 Hiki 5,45 Haul ma ka Kookala i Pahi i ke Kahi mua Area
2,9 Eka, Aina Kalo 2 Eka a Kena,

Apana 7, ma Waipuole Hoona ma ke Hamakua Kahi Komohana Akau
Holo Hom 3° Hiki 1,35 Haul ma ke Hamakua, Holo Hom 70° Ho 1,00 Haul ma ke Alanui, Ak 19°
Hiki 1,00 Haul ma ke Emerson o ka Punaui, Ak 82 1/2 Hiki 50, Haul, ma ka muliwai i ke
Kahi mua, Area 0,077 o ka Eka,

Apana 8 Kahuahale ma Uka, Hoona ma ke Kahi Komohana Akau, Koinike
Holo Ak 37 1/2 Ho 1,13 Haul ma Lohua, Holo Hom 66 3/4 Ho 92 Haul, ma ke Koinike Holo Hom
13° Hiki 1,42 Haul ma Kahawai o Alanui, Ak 56° Hiki 1,44 Haul ma ke Koinike i ke Kahi
mua, Area 0,15 o ka Eka,

Apana 9, Kona Pahale me Kiteahi aina Kalo, Hoona ma ke Kahi Koinike Akau
ma ka papohaku o Emerson, Holo Hom 5° Hiki 0,30 Haul ma ke Emerson Holo Hom 44° Hom 1,79 Haul
ma ke Emerson, Holo Hom 59° Ho 0,85 Haul ma ke Emerson Holo Hom 70 1/2 Hom 1,11 Haul ma ke
Emerson, Holo Ak 38° Hiki 5,30 Haul ma ka Papohaku, Holo Ak 67 1/2 Ho 5,07 Haul ma ka
papohaku, Alanui, Holo Ak 31° Ho 3,55 Haul, ma ke Alanui Holo Ak 46 3/4 Hiki 1,52 Haul
ma ke Koinike Ak 42° Ho 4,26 Haul ma ke Koinike Holo Ak 38° Hiki 1,17 Haul ma ke Koinike
Holo Ak 63 3/4 Hiki 2,40 Haul, ma ke Nana o Alanui, Holo Ak 67 1/2 Hiki 1,85 Haul ma ke Alanui
Alanui, Hiki Kona 14° Ho 1,00 Haul ma ke Alanui, Holo Ak 67 1/2 Hiki 1,85 Haul ma ke Alanui

Holo AK 79° Ni 319. Haul. ma Ke alani i Ke Pihia mua Area 3.65 Eka,

Apana 10. Hele ana ma Paalaa Ahupuaa Kumalii Mawalis Moomaka ma Ke pa aina Pihia Komohana Kema. Ke Kea, Holo AK $14\frac{1}{2}^{\circ}$ Ni 162 Haul, ma Ke Kea, Holo AK 27° Ni 382 Haul, ma Ke Kea, Holo AK 2° Ni 241 Haul, ma Ke muliwai Holo Ni 36° Ni 442 Haul i Ke loi Komohiki Holo Ni 4° Ni 384 Haul, ma Ke Haulowai i Ke pa aina Holo AK 84° Ni 73 Haul, ma Ke pa aina i Ke Pihia mua, Area 97 o ka Eka,

Apana 11. Pahale, Moomaka ma Ke Pihia Komohana Kema, Ke Haulowai pa hale a me Ke pa aina Holo AK 6. Ni 154 Haul ma Ke Haulowai Holo AK $86\frac{1}{2}^{\circ}$ Ni 274 Haul ma Ke Haulowai Holo Ni 11 Ni 273 ma Ke James. Robertson, Holo AK 74° Ni 348 Haul, i Ke pa aina i Ke Pihia mua, Area 6 o ka Eka,

Apana 12, Ke mau Poi a me Ke Kula, ma Ke Pihia Komohana Akau, Ke Kikai pahale, Holo AK $86\frac{1}{2}^{\circ}$ Ni 136 Haul, ma Ke Lalahina pahale, AK $86\frac{1}{2}^{\circ}$ Ni 35 Haul, ma Ke Kika pahale, AK 18° Ni 152 Haul, ma Ke Kepu aina AK 22° Ni 199 Haul ma Ke Kepu aina AK 12° Ni 150 Haul ma Ke Kepu AK $51\frac{1}{2}^{\circ}$ Ni 38 Haul, ma Ke Kepu aina AK 14° Ni 71 Haul ma Ke Kepu aina AK 70, Ni 124 Haul ma Ke Komohiki AK 2° Ni 200 Haul, ma Ke Komohiki Ni $19\frac{1}{2}^{\circ}$ Ni 235 Haul ma Ke Kahohalahala, Ni $53\frac{1}{4}^{\circ}$ Ni 78 Haul ma Ke Kahohalahala Ni 14° Ni 416 Haul ma Ke Kahohalahala, Ni $4\frac{1}{2}^{\circ}$ Ni 160 Haul, ma Ke Kahohalahala, i Ke Pihia mua, Area 85 o ka Eka,

Apana 13, Moomaka ma Ke Pihia Komohana Akau, Ke Kuiuwa aina ma Ke muliwai Holo Ni 8° Ni 158 ma Ke Kuiuwa Holo AK 74° Ni 108 Haul ma Ke Kika AK 87° Ni 124 Haul ma Ke Kahohalahala AK $3\frac{3}{4}^{\circ}$ Ni 120 Haul, ma Ke Manui Ni 82° Ni 250 Haul, ma Ke muliwai i Ke Pihia mua Area 31 o ka Eka

Maialua Jan 29, 1852

J. S. Emerson
Mea ana

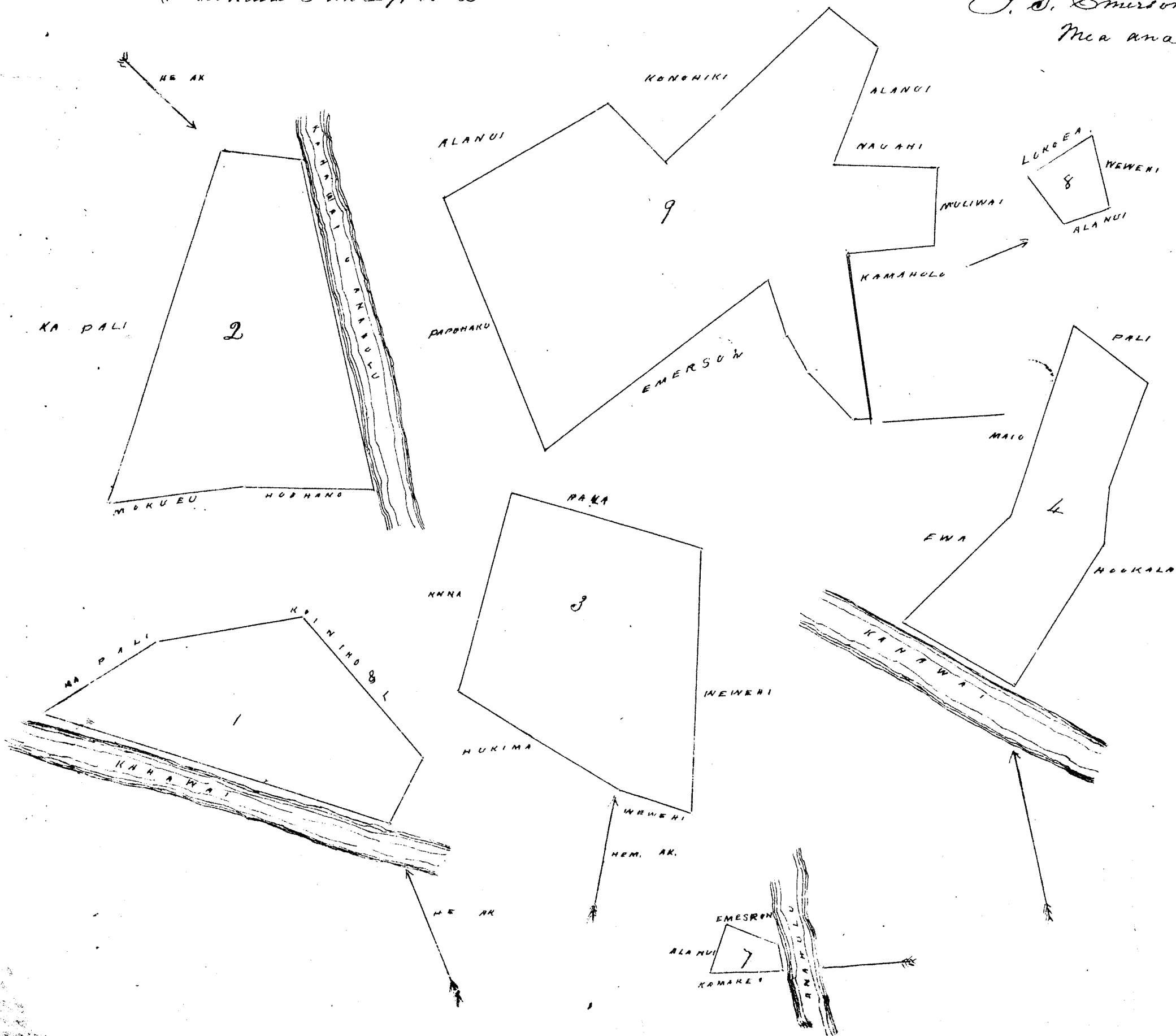

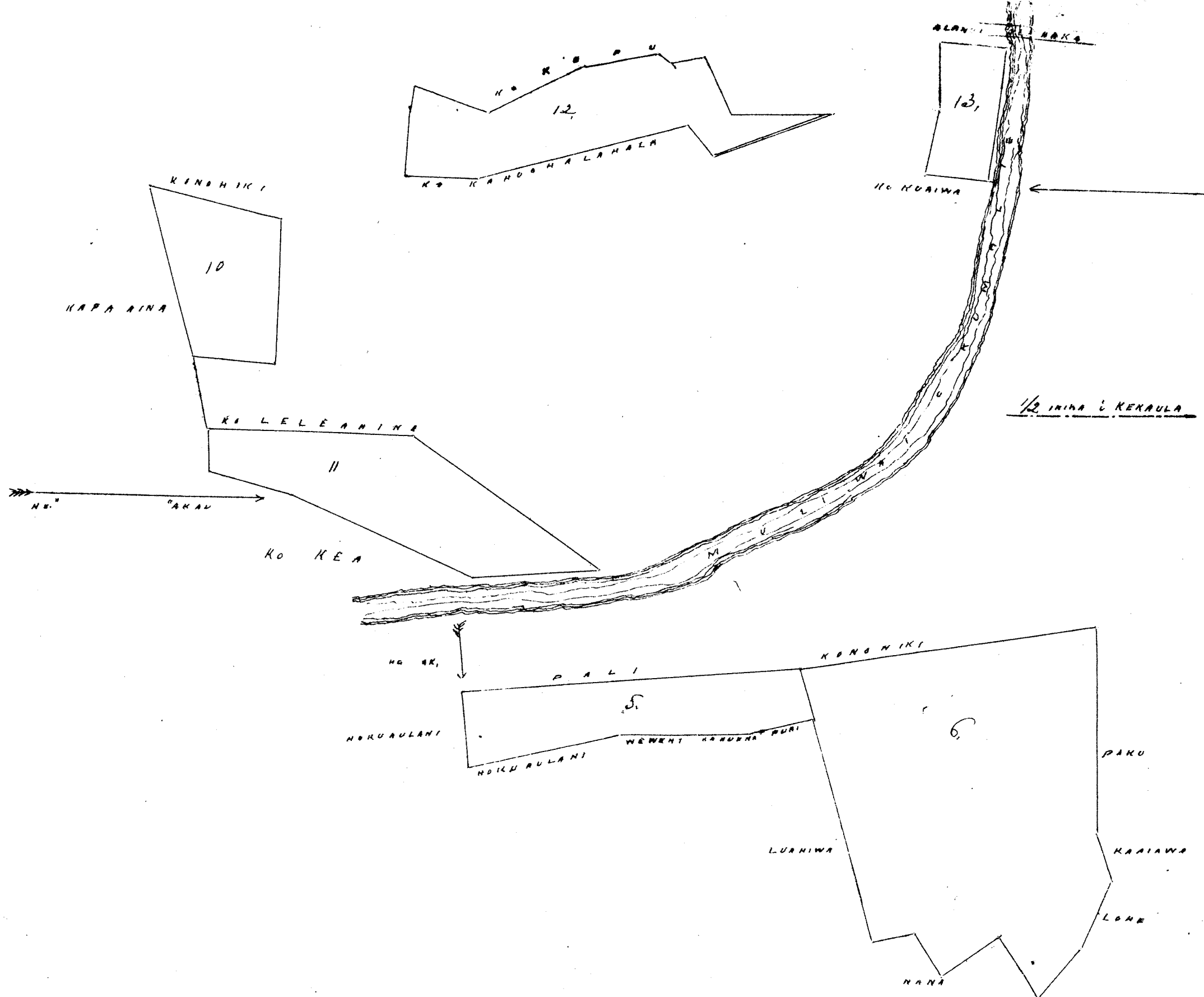

Wm Pau Isa \$ 14.00
 W. Lee
 J. Kaulapa
 S. A. Smith
 G. M. Robertson

Honolulu 10 Aug 1852

Hoetu 2749. Nakaahuahale - Kawaihoa Waiialua Oahu

Ko Nakaahuahale Puleana Kaimakole owa Kawaihoa Kai Waiialua Oahu
 Hoomaka owa ko Kealainana Piki Komohana Hema, holo hem 68 1/2 hem 339 haul, ma ko Konihi
 ki, holo hem 110 hiki 545, haul ma ko Konohiki holo AK 64 1/2 hiki 111 haul, ma ko Puaa hiki
 AK 62 1/2 hiki 313 haul ma ko Konohiki, holo, AK 51 1/2 hiki 56 haul ma ko Nakuahua hiki
 AK 31 hiki 140 haul ma ko Laanui Ika ma ko Gulick, holo, hem 70 hiki 158 haul ma
 ko Hokuaulani, hiki 19 hiki 0.26, haul ma ko Nakuahua, holo AK 70 hiki 138 haul
 ma ko Lii Konohiki, holo hem 31 hiki 600 haul ma ko Konohiki holo hem 51 1/2
 hem 225 haul ma ko Konohiki, holo hiki 27 1/2 hiki 1175 haul ma ko Konohiki holo hem
 70 hiki 50, haul ma ko Hokuaulani, AK 19 hiki 225 haul ma ko Hokuaulani, hem 11 1/2
 hiki 45 haul ma ko Kealainana Area 2,75 Eka i ka palama mua,

Hooleia Keia ana ana

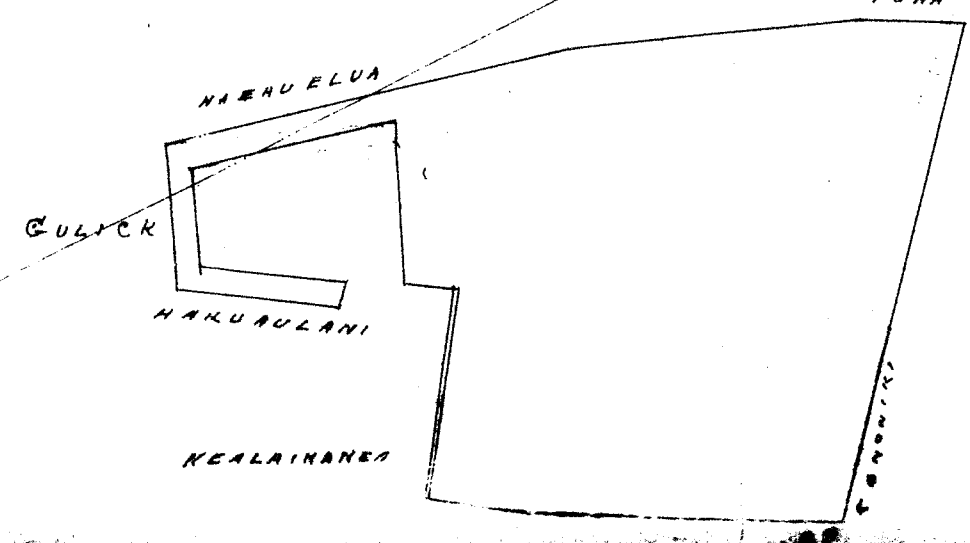

Oa ae ko Konohiki
 Waiialua July 9 1852, Mea ana
 J. S. Emerson

Nama Noav 357.

J. Kekaulahao
J. H. Smith
G. M. Robertson

Honolulu 15 Aug 1852

Ulu 2748 Nakuahua

Kawailoa Kaiawa Oahu

Ko Nakuahua mau aina ma Kawailoa a me Ulu Kaiawa Oahu.
Apana 1 Kalea Kawailoa Kai Oromaka ma ka Loke Kiki Kiki Kuma, o Ke Ka
Hahuahale auwai, Holo Hem 28 1/2 Ni 2,34 Haul ma Ke Laanui Loke, Holo Hem 63
Ho 2,95 Haul ma Ke Honohiki Holo Ke 20 Ni 20, Haul ma Ke Honohiki Holo Ke 48.
Ho 145 Haul ma Ke Nakuahua Ka auwai, Ak 32 Ho 210 Haul ma Honohiki Holo
Ak. 51 1/2 Ni 4,56 Haul ma Ke Nakuahale, i Ke Kiki mua Area 0,92 o Ke Eka

Apana 2, Kapiki a Kamalii Kawailoa Oromaka ma Ke ala Kahu Kiki Kiki
Kuma, o Ke Hokuaulani Loe, Holo Hem 30 Ni 205 Haul ma Ke ala mua, Holo Ke 46 Ni
Ho 158 Haul ma Ke alanui, Holo 7 1/2 Ho 2,75 Haul ma Ke alanui, Holo Ke 82 Ho 58
Haul ma Ke Luahiwa Ak 13 1/2 Ho 85 Haul ma Ke Luahiwa Ak 76 1/2 Ho 105 Haul
ma Ke Luahiwa Holo Ak 71 Ho 78 Haul ma Ke Honohiki Holo Ak 29 Ni 53 Haul ma
Ke Honohiki Ak 64 Ni 157 Haul ma Ke Hokuaulani Holo Ak 23 Ho 181 Haul
ma Ke Hokuaulani, Holo Ak 58 Ni 2,05 Haul ma Ke Hokuaulani i Ke Kiki mua Area
84 o Ke Eka,

Apana 3, Ka aina ma Ke pa ipu ma Ulu Oromaka ma Ke Kiki o Ke pa,
Holo Ak 73 3/4 Ni 452 Haul ma Ke Kanahi Holo Ak 50 Ni 3,70 Haul ma Ke Koiniho Holo Ak 20
Ni 4,30 Haul ma Ke Koiniho Holo Ak 53 1/2 Ho 450 Haul ma Ke Papohaku, Holo Ke 43 1/2
Ho 5,74 Haul ma Ke Papohaku, Ho 11 Ho 5,40 Haul ma Ke papohaku i Ke Kiki
mua, Area 45 Eka

Waiawa Iulai 15, 1852, J. S. Emerson

Mea ano,

92
84
45
46.76

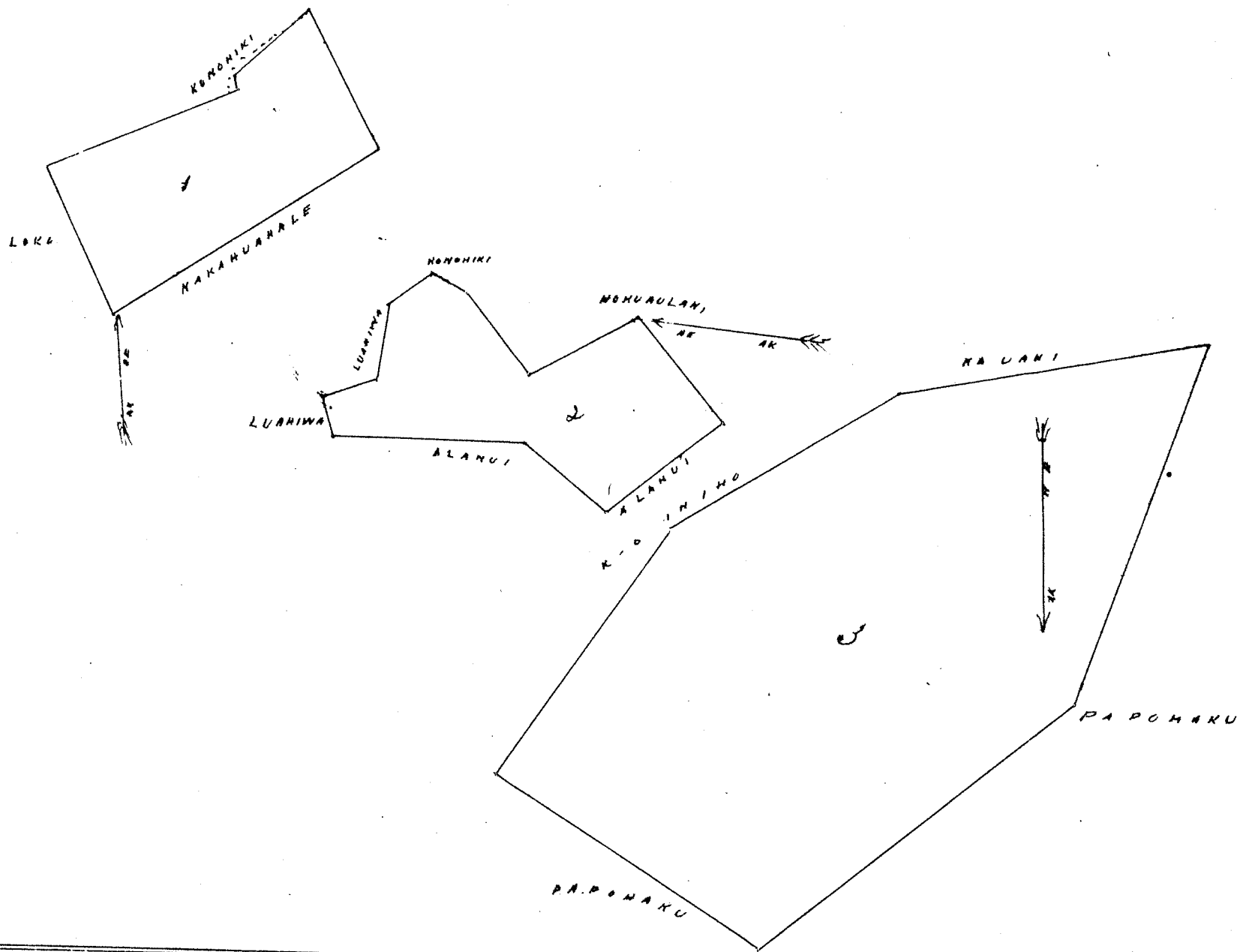

Ulu

J. Kekaulahao
J. H. Smith
G. M. Robertson

Honolulu 15 Aug 1852

Keolu 273 Kealohuluhulu

Paalaa Waialea Oahu

Ke Kealohuluhulu Kuluana ma Aukala Paalaa Waialea Oahu.

Apana 1. E hoomaka ma ke kiki Komohana Aka. Kona papohaku, Holo Ak 76 Hi 137 Kaul pa hale Kula, Holo Hem 14 Hi 477 Kaul ma ke papohaku Holo Hem 74 Hi 547 Kaul ma ke papohaku a hiki i ke Kai aite awaha Holo Ak 77 Hi 955 Kaul ma ke Kai aite awaha Holo Ak 4 Hi 1015 Kaul ma ke alanui a hiki i kahi i hoomaka ai Ke area 8.73 Eka.

Apana 2. Hoomaka ma ke kiki Pitina Aka. Ke Kahohalahala aina Kala ma Alapii Paalaa, Holo Ak 81 1/2 Hi 0.90 Kaul, ma ke Kahohalahala, Holo Ak 3 Hi 0.70 Kaul ma ke Kahohala, lahala, Holo Ak 86 1/2 Hi 0.76 Kaul, ma ke Kahohalahala, Holo Ak 6 1/2 Hi 0.57 Kaul ma ke Konoiki Holo Ak 7 1/2 Hi 0.64 Kaul, ma ke Konoiki Ak 86 1/2 Hi 1.75 Kaul ma ke Konoiki Holo Hem 3. Hem 2.20 Kaul, ma ke Hika i ke kiki mua, Area 32 o Ke Eka.

Apana 3. ma Alapii Paalaa Hoomaka ma ke kiki Komoh. Kema, Ke ke Konoiki. Ii Alapii Holo Ak 29 1/2 Hi 1.68 ma ke Konoiki Holo Hem 37 Hem 3.96 Kaul, ma ke muliwai Holo Hem 36 1/2 Hi 1.00 Kaul ma ke Heawenuku Holo Ak 49 1/2 Hi 3.50 Kaul ma ke Hika i ke kiki mua, Area 46 o Ke Eka.

Apana 4. ma Kawailoa Kahi Hoomaka ma ke kiki Pitina Aka. Eulike a Holo Ak 65 Hi 1.63 Kaul, ma ke Kahue aina Holo Hem 30 Hi 1.80 Kaul ma ke Konoiki Holo Hem 82 Hi 1.30 ma ke Konoiki Holo Hem 14 Hi 0.64 Kaul ma ke Lanui auwai Holo Ak 37 Hi 3.80 Kaul ma ma ke Eulike mau Ii i ke kiki mua, Area 0.64 o Ke Eka.

Apana 5. ma Kawailoa Hoomaka ma ke Kahue kiki Pitina Kema Holo Hem 7 Hi 0.15 ma ke Konoiki Holo Ak 84 3/4 Hi 1.75 Kaul ma Konoiki Holo Ak 19 Hi 2.00 Kaul, ma ke Kawelu Holo Ak 69 1/2 Hi 78 Kaul, ma, Kekahi lili o Kawelu, Holo Ak 37 Hi 84 Kaul, ma ke Kahue i ke kiki mua, Area 0.28 o Ke Eka.

8.73
32
51 46
64
92 28
1243

Waialea July 6, 1852.

J. S. Emerson
Mea ana.

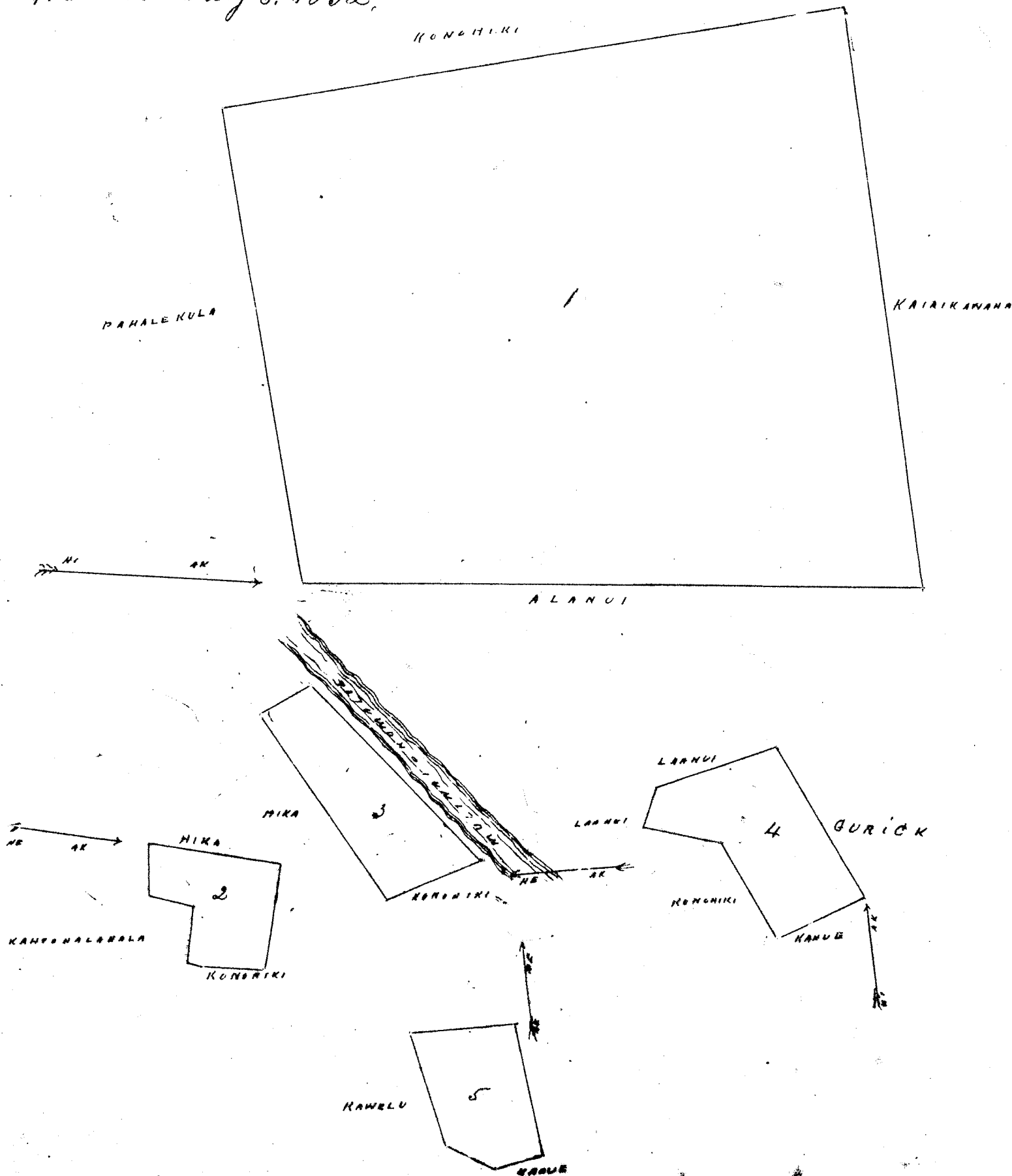

Uka Pau Loa # 10

W. H. M. Robertson
J. Kekaulahao
J. H. Smith

Honolulu 16 Aug 1852

Keolu 10364 Lonokaku or Nonokaku Waiialua Oahu

Ki Lonokaku or Nonokaku, ^{mau aina} ma Waiialua Oahu.

Apana 1 Kona Papale ma Lauhulu, Koomaka ma Ka pahu; ka pa aina holo Ke 45 1/2' Hi 2.00 Kaul ma Ke Konoiki holo AK 44 1/2' Hi 1.25 Kaul ma Ke Konoiki holo AK 45 1/2' Hi 2.00 Kaul ma Ke Konoiki holo AK 44 1/2' Hi 1.25 ma Ke Konoiki i ke kiki mua Area 0, 25 Eka,

Apana 2 Kona Kuleana ma Lauhulu, Koomaka ma Ke kiki Koomaka holo Ke 53 1/2' Hi 9.50 Kaul i Ka pali holo AK 73 1/2' Hi 11.70 AK 65' Hi 12.50 Kaul ma Ke Healainana holo 23 1/2' Hi 9.55 ma ka pa i ke kiki mua, 11.12 Eka

Apana 3 Kona Aina Kale ma Hawaiiwa Kai, Koomaka ma Ke kiki Kikina holo Ke 61 1/2' Hi 1.07 Kaul ma Konoiki holo Ke 29 3/4' Hi 1.56 Kaul ma Ke Kaula holo Ke 64 1/2' Hi 1.35 Kaul ma Ke Kaula holo Ke 31 1/4' Hi 1.58 Kaul ma Ke Healainana holo Ke 61 3/4' Hi 2.39 Kaul ma Ke Healainana holo Ke 27 5/4' Hi 1.67 Kaul ma Ke Keawe holo Ke 29' Hi 1.40 ma Ke Keawe i ke kiki mua, Area 0, 537.0 Eka

Ua ae Ke Konoiki;
Waiialua, July 30, 1852,

J. S. Emerson
Mua ana

250
11 500
537
12287

HEALAINANA

PA PUNAKU

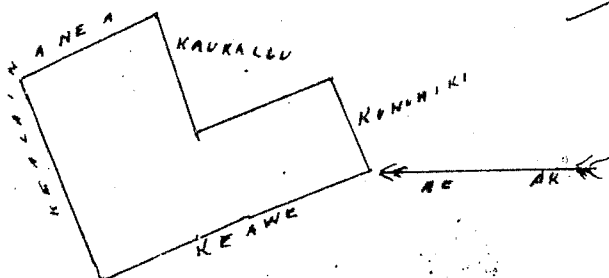
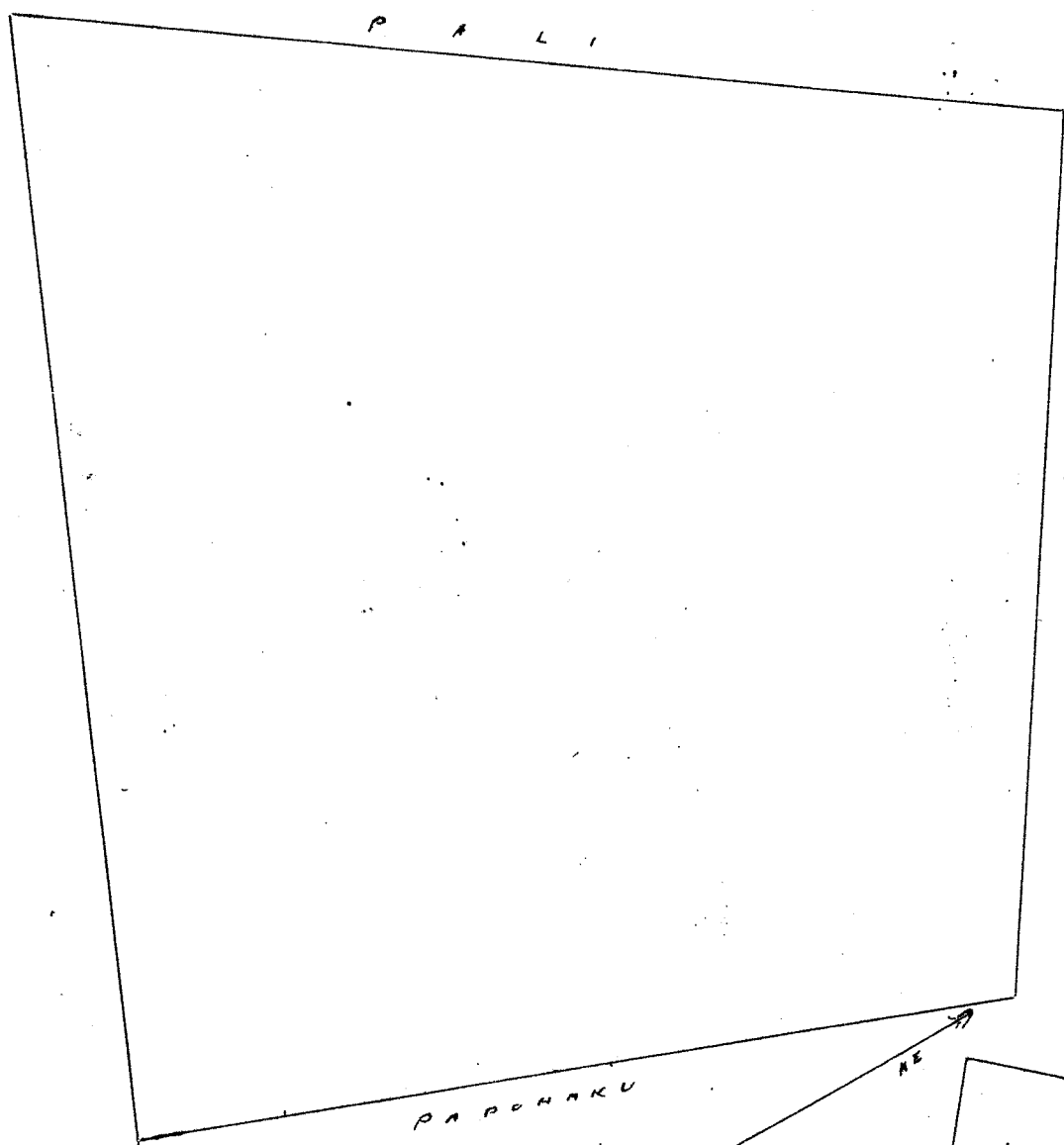

Uka Pau Loa # 8

W. H. M. Robertson
J. Kekaulahao
J. H. Smith

Honolulu 16 Aug 1852

Kelesu 9951 & 9970 S. Laanui

Kawailoa Waiakua Oahu

Ke Laanui Kuluana ma Kawailoa

Apana 1. Maniukukahi mauka o Kawailoa Hoouaka ma ke kiki kikiina Aka ma ke Kahawai, Holo Num 85° Hi 4,22 Haul ma Kahawai, Holo Ak 80 1/2° Hi 7,62 Haul ma ke Kahawai, Holo Num 9° Hi 4,30 Haul, ma ke Honohiki Holo Num 89 1/2° Hi 11,15 Haul i ka pali Holo Ak 2 1/2° Hi 3,60 Haul ma ke Honohiki i ke kiki mua Area 4,1 Eka, (4 1/10 E)

4. 10
7
23
50
18 28
23
15
42
277

Apana 2. Kookahi loi ma Kawailoa Kai ma Ke Anahulu, Hoouaka ma ke kiki Hoouaka Aka. Ke Kamahala Loi ma ka muliwai a Holo Ak 81° Hi 6,65 Haul ma ke Anahulu, Holo Num 20° Hi 29 Haul, ma ke Anahulu, Holo Num 5° Hi 50 Haul, ma ke Kooka, Ak 89 1/2° Hi 1,08 Haul, ma ke Kamahala, Ak 6° Hi 0,61 Haul ma ke Kamahala, i ke kiki mua Area 0,77 Eka, (7/100 E)

Apana 3. Kawailoa Kai ma ke Anahulu, Hoouaka ma ke kiki Hoouaka Aka. Ke Puhii Loi, Holo Ak 75° Hi 3 Haul, ma ka muliwai Holo Num 2° Hi 6,25, ma ka pali ke Maunui, Holo Num 83° Hi 2,05 Haul, ma ke Honohiki Holo 84° Hi 71 Haul, ma ke Kooka Holo Ak 16° Hi 37 Haul, ma ke Puhii i ke kiki mua, Area 2,32 o ka Eka, (23/100 E)

Apana 4. Kona Pahala ma Kawailoa Hoouaka ma ke pali pahala, ka aina Holo Hi 37 1/2° Hi 2,16 Haul, ma ke Honohiki Holo Num 60° Hi 2,99 Haul ma ke Ala Uuku, Holo Ak 28° Hi 2,28 Haul ma ke Hoku aulani Holo Ak 62 1/2° Hi 2,10 Haul ma ke Hoku aulani i ke kiki mua Area 0,5 o ka Eka, (5/10 E)

Apana 5. Ke loi ma Kawailoa Kai Hoouaka ma ke kiki kikiina Kona. Ke Loi Honohiki o Paala, Holo, Num 31 1/2° Hi 2,48 Haul ma ke Honohiki Holo Num 63 1/2° Hi 0,60 Haul ma ke moa, Ak 67 1/2° Hi 2,00 Haul, ma ke Kapule o Holo Ak 18° Hi 1,98 Haul, ma ke Paala auwai Hi 57 1/2° Hi 6,6 Haul ma ke Paala i ke kiki mua Area 0,28 o ka Eka, (28/100 E)

Apana 6. Ke loko ma ka Aka. Paalaa, Kapaia. Pumahoolapa, ma na Loi Hoouaka ma ke Katakahala Loi kiki kikiina Kona, Holo Ak 51° Hi 70 p. auku ma ke auwai, Holo Ak 74 1/2° Hi 2,63 Haul, ma ka auwai Holo Ak 20° Hi 93 Haul ma ke Honohiki Holo, Ak 33 1/2° Hi 93 Haul ma ke Honohiki Holo Ak 81° Hi 1,90 Haul ma ke Honohiki Holo Num Hi 2,67 Haul ma ke Makuaee o Puaa Holo Ak 39 1/2° Hi 54 Haul ma ke Puaa Holo Num 82° Hi 80 Haul, ma ke Puaa Holo Num 6° Hi 3,00 Haul ma ke Puaa, Hi 66 1/2° Hi 2,32 Haul ma ka Auwai ma Paalaa Ak 70 1/2° Hi 1,21 Haul ma ka Auwai ma Paalaa, Hi 58 1/2° Hi 1 Haul, ma ka Auwai ma Paalaa Ak 27° Hi 3,72 Haul ma ke Honohiki a ma atachua i ke kiki mua, Area 2,2 Eka, (22/10 E)

Apana 7. Hoouaka ma ke Kawahamana pahala kiki kikiina Kona, Holo Ak 76° Hi 1,25 Haul ma ke Kawahamana Num 1° Num 76 Haul, ma ke Kawahamana, Num 3° Hi 17 Haul ma ke Kawelu Ak 74 1/2° Hi 80 Haul, ma ke Makuaee Ak 9° Hi 2,34 Haul ma ke Honohiki i ke kiki mua, Area 0,15 o ka Eka (15/100)

Apana 8. Ke Laanui ma ka mala ipu o Ukoa, Hoouaka ma ke kiki kikiina Kona. Paala, Holo, Ak 79° Hi 2,14 Haul ma ka pali pahala Holo Ak 2 1/2° Hi 2,00 Haul ma ke Makuaee Holo Hi 73° Hi 2,40 Haul ma ke Honohiki Holo Hi 9 1/2° Hi 2,00 Haul ma ke Puaa i ke kiki mua, Area 4,2 Eka (42/100 E)

Waiakua Iulai 13, 1852

J. S. Emerson
Mea ana

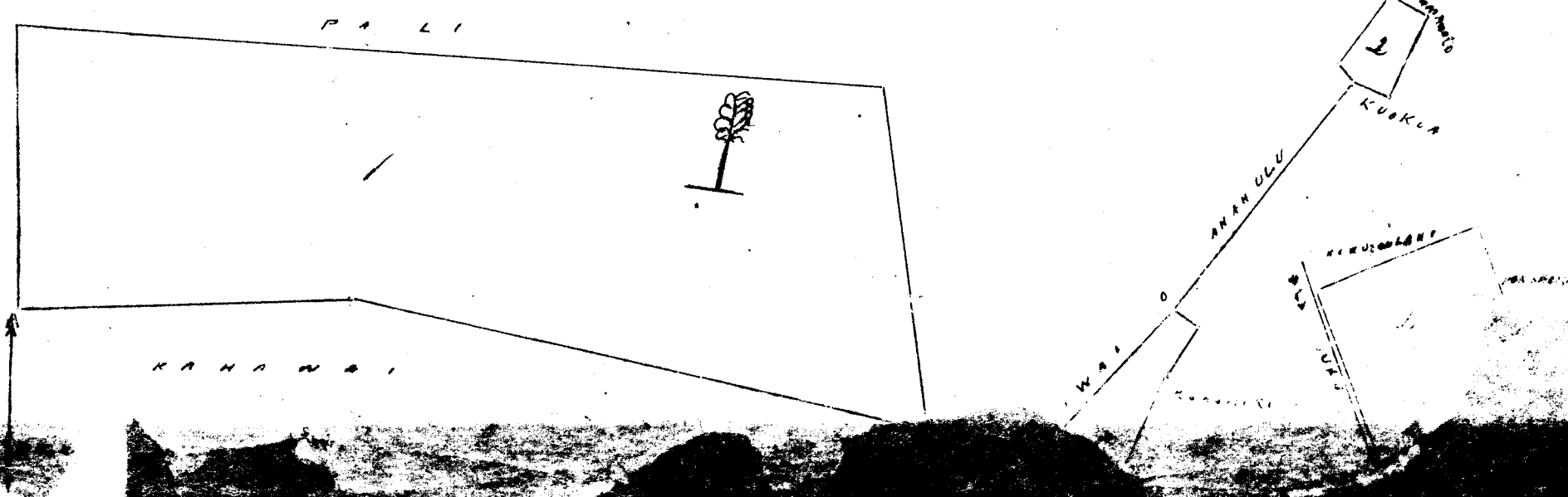

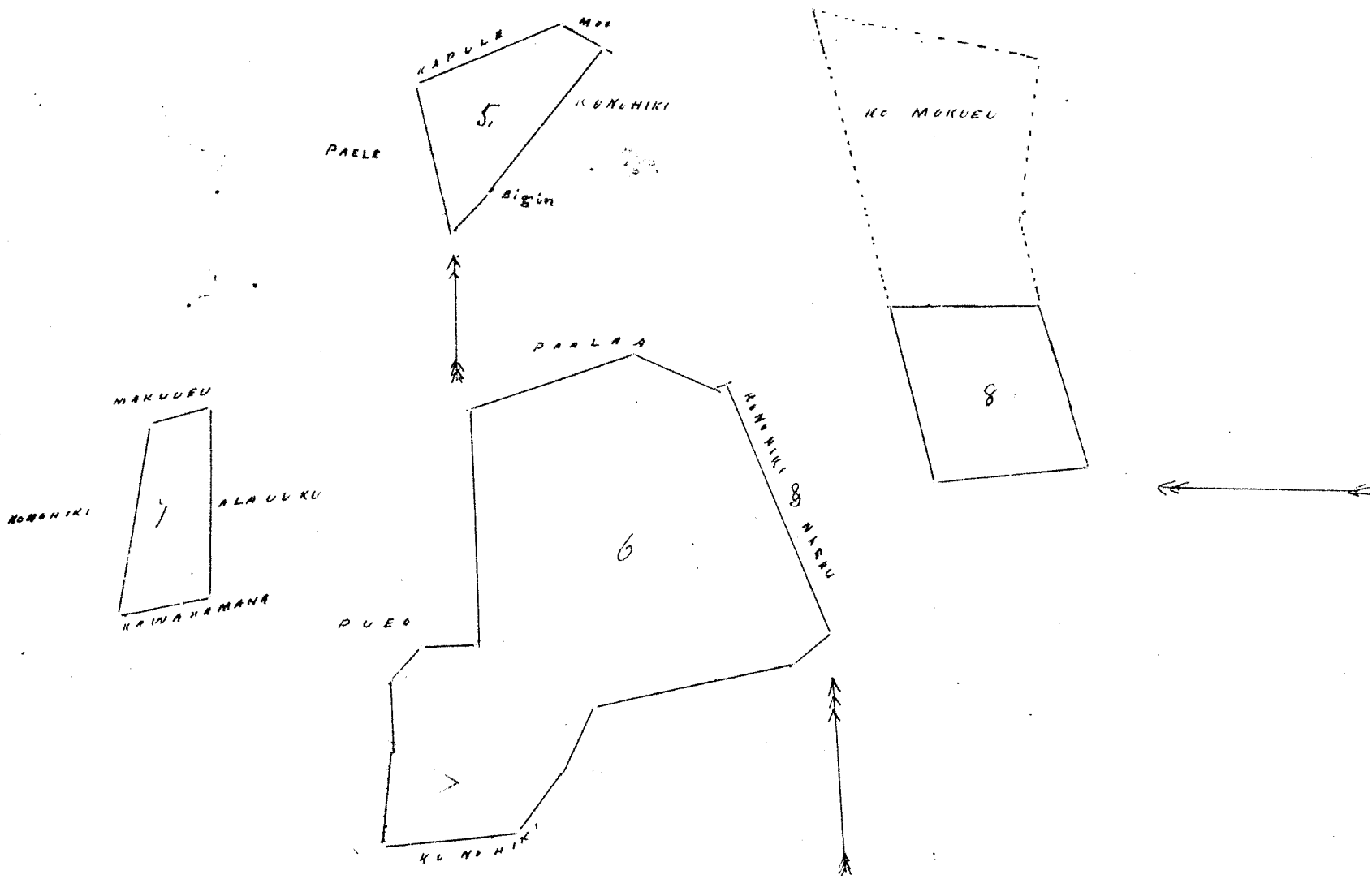

S. W. Pau \$ 10
G. M. Robertson
J. H. Smith
J. Hekaulahas

Honolulu 16 Aug 1852

Kolu 2741 Pua

Kawailoa Waialua Oahu

Apana 1. ma Moemua akehe Kawailoa
Avomaka ma ke Kaanana Kiki Kimoehana Akau Apana 2, Solo hem 13 1/2 Hom 270 Kaul,
ma Kahawai, Solo hem 19° Hi 219 Kaul ma Kimoehiki Solo hem 68° Ho 295 Kaul ma Kimoehiki
At 14 1/2 Hom 230 Kaul ma Kimoehiki Solo At 23 1/2 Hom 141 Kaul ma Kimoehiki Solo Hem 37°
Ho 342 Kaul ma Kahawai, Solo hem 8 1/2 Ho 400 ma ke Kimoehiki Solo At 61° Hi 790
Kaul, ma ka pali, Solo At 64° Hi 339 Kaul ma ka pali, Solo At 7 1/2° Hi 100 Kaul
ma ke Kaanana, i ke Kiki mua, Area, 3,55 Eka,

Apana 2, Ma Kawailoa Kai Avomaka ma ke Mokueu Kiki Kikina Kona,
Solo Hem, 84 1/2 Ho 703 Kaul ma Mokueu, Solo, Hem 1. Ho 0,98 Kaul ma ke Laanui - Solo
Hem 40° Ho 0,54 Kaul, ma ke Laanui, Solo Hem 82° Ho 0,80, Solo Hem 61° Hi 3,00 Kaul
ma ke Laanui, At 78 1/2 Hi 6,66 Kaul ma Paalaa - Kairikawaha, ma, At 24 Hi 380 Kaulaka
ma ke Kimoehiki i ke kiki mua, Area 2,1 Eka,

Apana 3, Mala uwala ma ka pahua Akua, Avomaka ma ke Kiki Kikina
Akau, o Wewehi, At 27 1/2 Hi 2072, Kaul ma ka pahua pohaku, Solo Ho 81 Ho 458 Kaul,
Ma ke Kaanana, Solo hem 7 Ho 2,30 Kaul ma ke Moo, At 80° Hi 260 Kaul ma ke
Wewehi Area 80, o ka Eka Ua ae ke Kimoehiki

Waialua July 14, 1852

J. S. Emerson

3.55
2.10
86
5.57

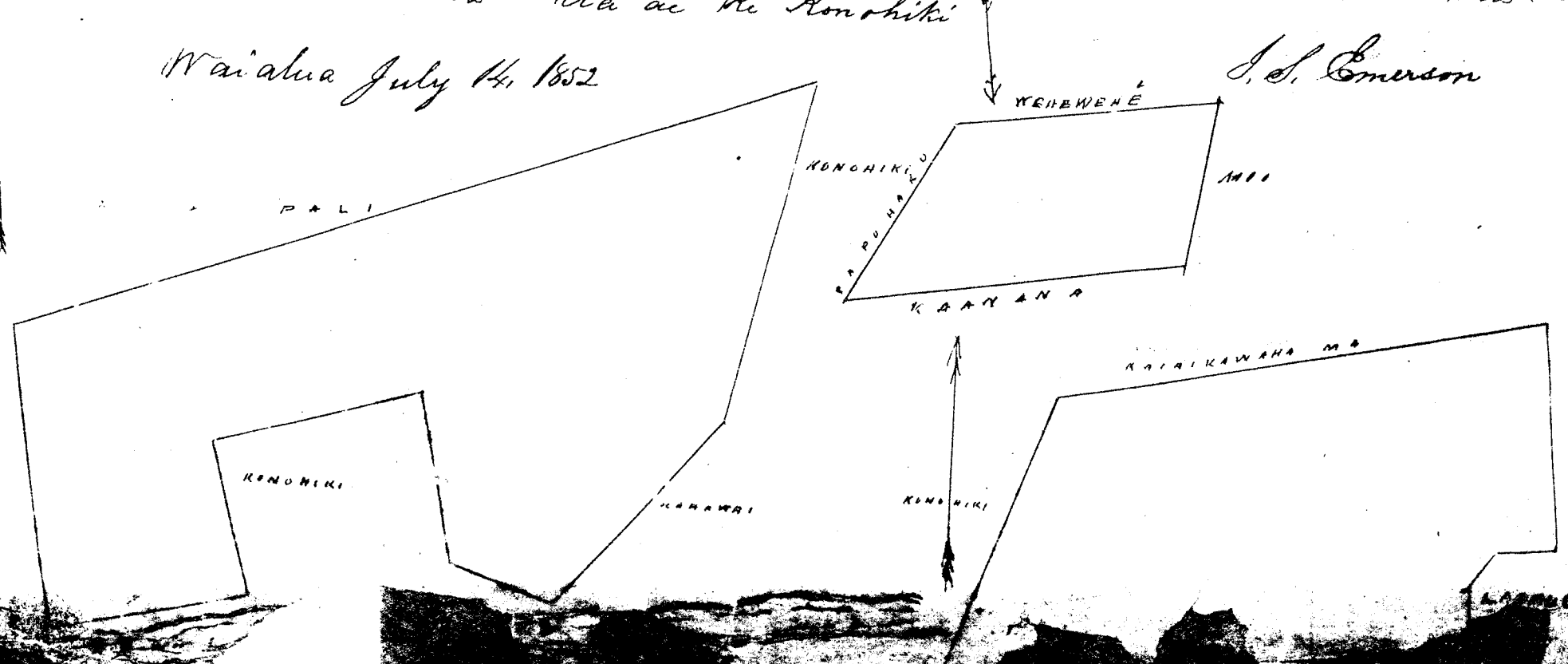

W. H. H.

J. Kekaulahao
G. M. Robertson
J. H. Smith

Honolulu 16 Aug 1852

Heleu 2728^B Maia

Kawailoa Maialua Pah

He Maia mau aina ma Kawailoa Kai Maialua

Apana 1. Aina Pahale, hoomaka ma ka paku, kahi kikiina hema. ke pa
hola Ak 3 1/2 Km, 0.70 Haul ma ke alanui, hola Ak 80 1/4 Km 1.16 Haul ma ka muliwai
hola Ak 87 1/2 Km 1.35 Haul ma ka muliwai hola Km 5 1/2 Ni 1.56 Haul ma ke Luahina hola
Ak 83 Ni 2.98 Haul ma ka pa aina i ke kiki oona, Area .36 o ka Eka

Apana 2. Aina Kala ma Kawailoa Kai hoomaka ma ke kahi kiki kimoana
Ak au, hola Ak 27 3/4 Km 1.67 Haul ma ke Komoakahu, hola Ak 29 Km 1.40 Haul ma ke Komoakahu
Ak 5 1/2 Ni 2.11 Haul ma ke Alanui hola Ak 6 Ni 1.24 Haul ma ke Kahaue hola Km 20
Ni 1.04 Haul ma ke Pilipi hola Km 53 1/2 Ni 0.54 Haul ma ke Pilipi hola Ni 24 Ni 2.88 Haul
ma ke Pilipi hola Ni 58 1/2 Ni 55 Haul ma ke Wehelaue, hola Km 30 Ni 1.40 Haul ma ke
Wehelaue, hola Ni 65 1/2 Ni 68 Haul ma ke Kahaue, hola Km 15 Ni 1.45 Haul ma ke
Kahaue, hola Km 80 Ni 1.24 Haul ma ke Kahaue, i ke kiki oona Area 1.11 Eka

Apana 3. Ma Kawailoa Kai, Kapaia o Kaniula hoomaka ma ke kiki kimoana
hona Ak au, o ke Kahaue aina hola Km 24 Ni 3.80 Haul ma ka pa aina Ni 3 1/2 Ni 2.90
Haul ma ka pa aina, hola Ak 88 Ni 2.65 Haul ma ke Komoakahu Ak 25 Ni 6.24 Haul ma ke
Kahaue, i ke kiki oona, Area 1.21 Eka. Ma ke Komoakahu
Maialua Iulai 30, 1852

36
1.11
1.21
2.88

J. Emerson
Maia

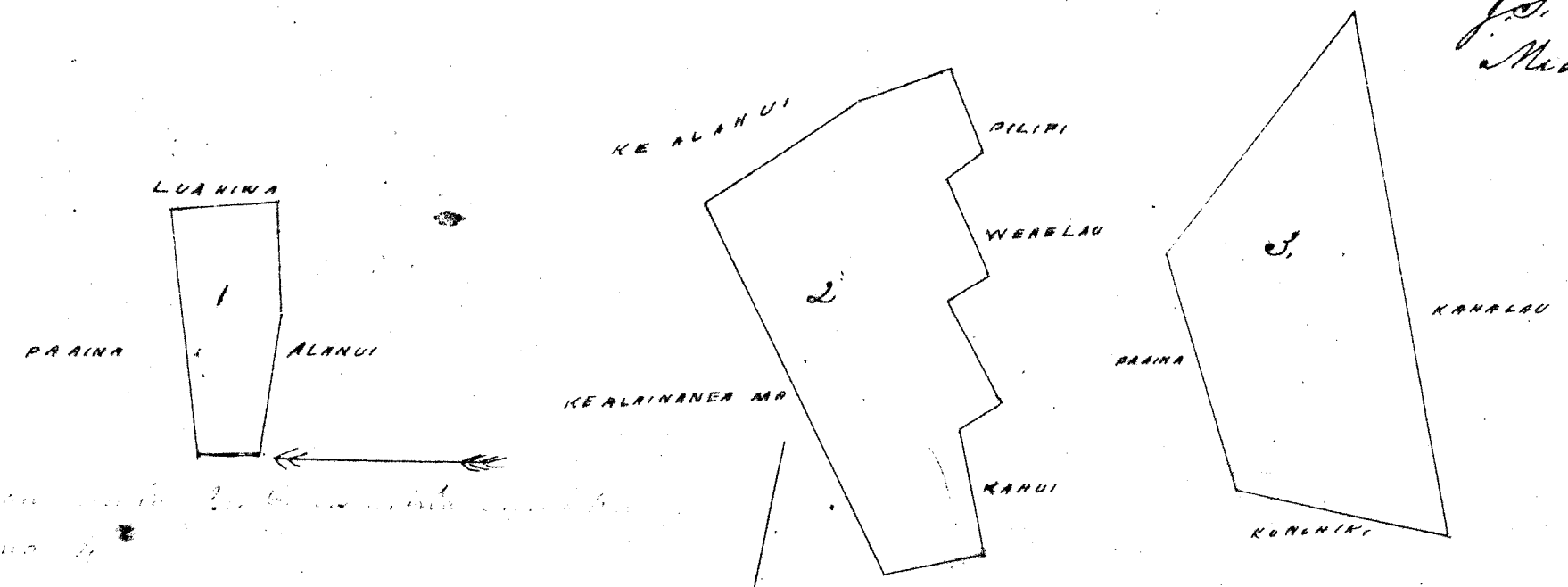

W. H. H.
G. M. Robertson
J. Kekaulahao
J. H. Smith

Honolulu 16 Aug 1852

Heleu 2726 Puakali

Paalaa Maialua Pah

He Puakali mau aina ma Paalaa
Apana 1. Aina Kala, hoomaka ma kahi hema 20 Ni 82 paau ma ke kiki kiki hema. o ke Komoakahu
hona ma ke kiki hola Ni 5 1/2 Ni 1.21 Haul ma ke Komoakahu hola Km 14 1/2 Ni 3.44 Haul ma ke Komoakahu
hola Ak 81 Ni 1.68 Haul ma ke Komoakahu hola Ak 23 1/2 Ni 1.10 Haul ma ke Komoakahu i ke kiki oona Area 0.58 Eka

Apana 2. Aina Kahaue ma Paalaa Kai hoomaka ma ka paku ma ke al. o ka kiki
hola Km 75 Ni 2.50 Haul ma ka pa aina Ni 15 Ni 1.00 Haul ma ka pa aina Ak 75 Ni 2.50 Haul
ma ke Komoakahu Ak 25 Ni 1.00 Haul ma ke Komoakahu i ke kiki oona, Area 0.25 o ka Eka

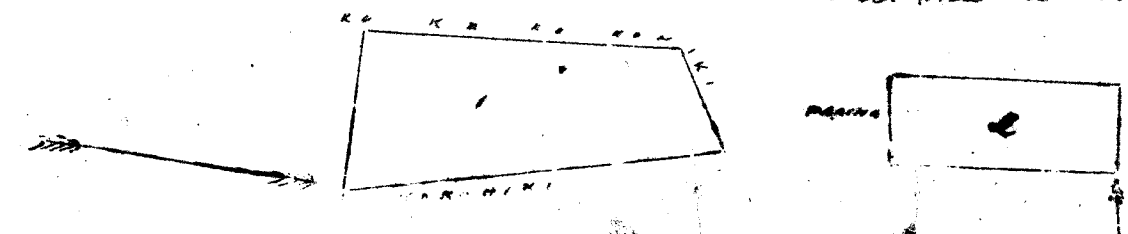

Maialua Iulai 6, 1852

J. Emerson
Maia

Uku Pau Loa # 5
M. K. K.
J. H. Smith
J. Kekaulahas
G. M. Robertson

Honolulu 16 Aug 1852

Helu 4305 Kauhalaui

Kawailoa Waialua Pahū

Ke Kauhalaui mau aina ma Kawailoa Kai Waialua

Apawa 1. Kona pahale - Kaniula Houmaka ma ke Piki Nihina. ka Li' Honohiki
Holo Ak 31' Ho 0,50 Haul ma Heawe, Holo Ak 83 1/2' Ho 3,00 Haul ma ka pa aina Holo Hem 3 1/2'
Hi 2,63 Haul ma Honohiki Holo Ak 38 1/2' Hi 2,65 Haul ma ka Honohiki i ke Nihimua
Area 0,41. ka Eka

Apawa 2. Kona aina Kaniula Houmaka ma ke Piki Nihina. Akau. ke
Piliipi Pahale, Holo Ak 40' Ho 1,83 Haul ma Honohiki Holo Hem 61' Ho 1,50 Haul ma Honohiki
Holo Ak 30' Ho 2,81 Haul ma Honohiki Holo Hem 8 1/2' Ho 7,34 Haul ma ka pa aina
Holo Hem 25' Hi 6,24 Haul ma ka Heawe, Ak 80' Hi 3,50 Haul ma Honohiki Holo Ak 54 1/2'
Hi 3,33 Haul ma ka auwai, Ak 22' Ho 0,86 Haul ma ka Hahue pa hale Holo Ak 48'
Hi 1,32 Haul ma ka Hahue pahale, Holo Hem 23' Hi 0,50 Haul ma ka Hahue pa hale
Holo Ak 42 1/2' Hi 1,37 Haul ma ka Piliipi i ke Nihimua, Area 5,53 Eka
Ua ae ke Honohiki

Waialua July 13, 1852

J. S. Emerson
Moa ana

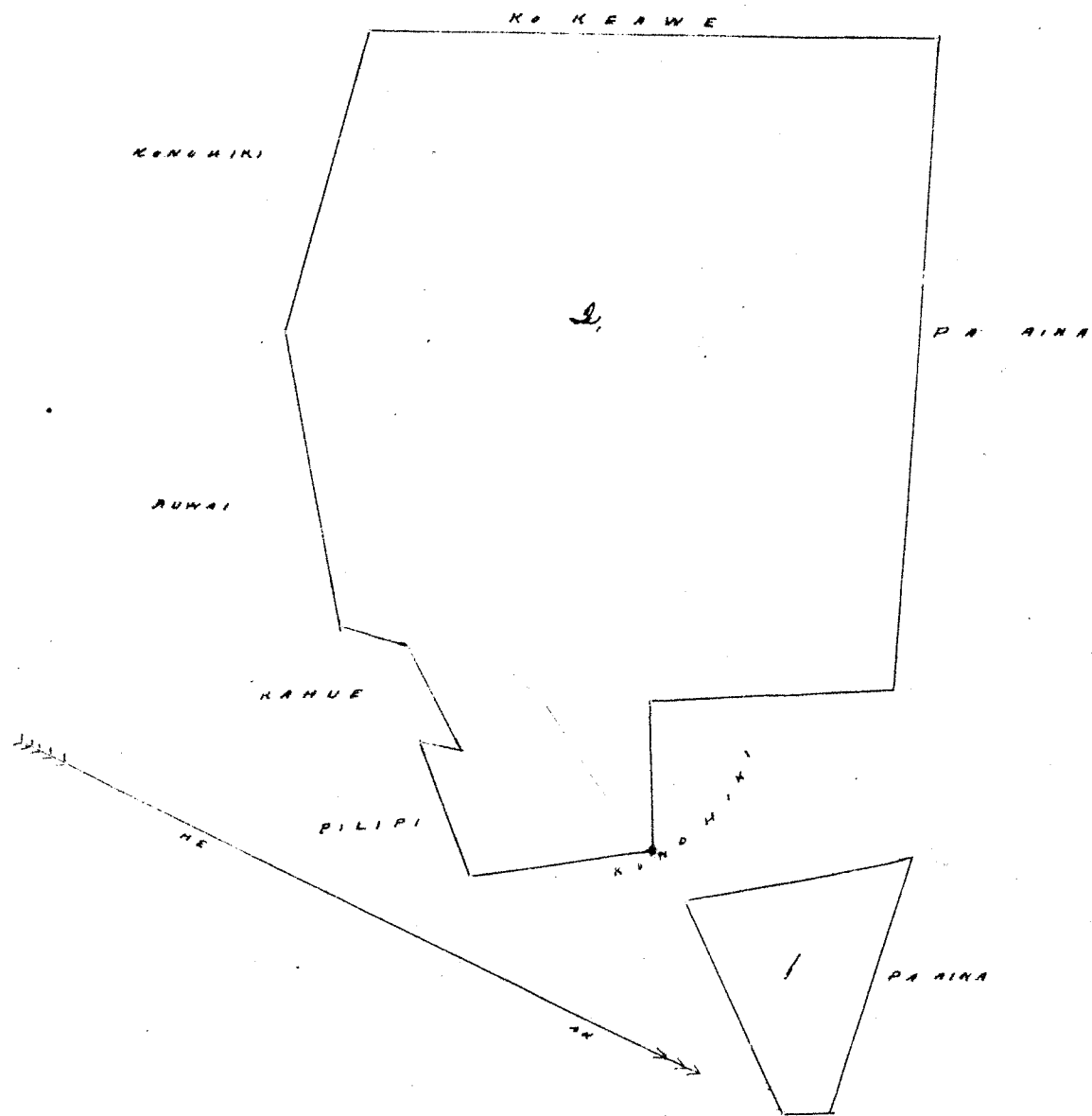

Uku Pau Loa # 7
M. K. K.
G. M. Robertson

J. Kekaulahas
J. H. Smith

Honolulu 16 Aug 1852

Ke Luakivua aino

Apama 1. Hoomaka ma ke muliwai ma ke Kapunawai Kiki Akau loa, holo Ak 71° Ke Ke hana ma Anahulu, holo hem 6 1/2° Ke 233 Kaul ma ke Kaholokai, holo hem 81° Ke 146 Kaul ma ke Kaholokai holo hem 8 1/2° Ke 433 Kaul ma ke Kuroka, holo Ak 80° Ke 186 Kaul ma ke Pahi, holo Ak 6 1/2° Ke 470 Kaul ma ke Kapunawai, Ak 4 1/2° Ke 073 Kaul ma ke Kapunawai, holo Ak 8 1/2° Ke 070 Kaul ma ke Kapunawai, holo Ak 0 1/2° Ke 188 Kaul ma ke Kapunawai, i ke Pahi mua, Area 0.39 Eka

Apama 2. Anahulu Kai Hoomaka ma ke Kiki Kikina Pema, o ke Kachulua aino ma ke alani, holo hem 9° Ke 095 Kaul ma ke alani, holo hem 83° Ke 207 Kaul ma ke Kahakai holo Ak 16° Ke 198 Kaul ma ke Kapule, holo Ak 68 1/2° Ke 104 Kaul ma ke Konoiki holo hem 76 1/2° Ke 165 Kaul ma ke Kachulua, holo hem 13 1/2° Ke 85 Kaul ma ke Kachulua Ak 82° Ke 58 Kaul ma ke Kachulua i ke Pahi mua, Area 0.4 o ka Eka

~~Apama 3. Ma Anahulu Kai ma, Hoomaka ma ke Kawahamaa Kiki Konoiki ma Kaula, holo Ak 36 1/2° Ke 080 Kaul ma ke Kawahamaa holo Ak 55° Ke 46 Kaul ma ke Kahakai holo hem 80° Ke 170 Kaul ma ke Kelauna, holo hem 2° Ke 80 Kaul ma ke Kelauna, holo Ak 86° Ke 260 Kaul ma ke Kaula i ke Pahi mua, Area 0.18 o ka Eka~~

Apama 4. Ke Luakivua pahale ma Anahulu Kai, Hoomaka ma ke Kiki Konoiki Akau, o ke Keawe pahale, holo hem 84° Ke 148 Kaul ma ke ala, holo hem 8 1/2° Ke 139 Kaul ma ke Konoiki, holo Ak 83° Ke 150 Kaul ma ke Keawe aino Ak 5 1/2° Ke 156 Kaul ma ke Keawe i ke Pahi mua Area 0.21 o ka Eka

Waialua July 20 1852

J. S. Emerson,
Mea ana

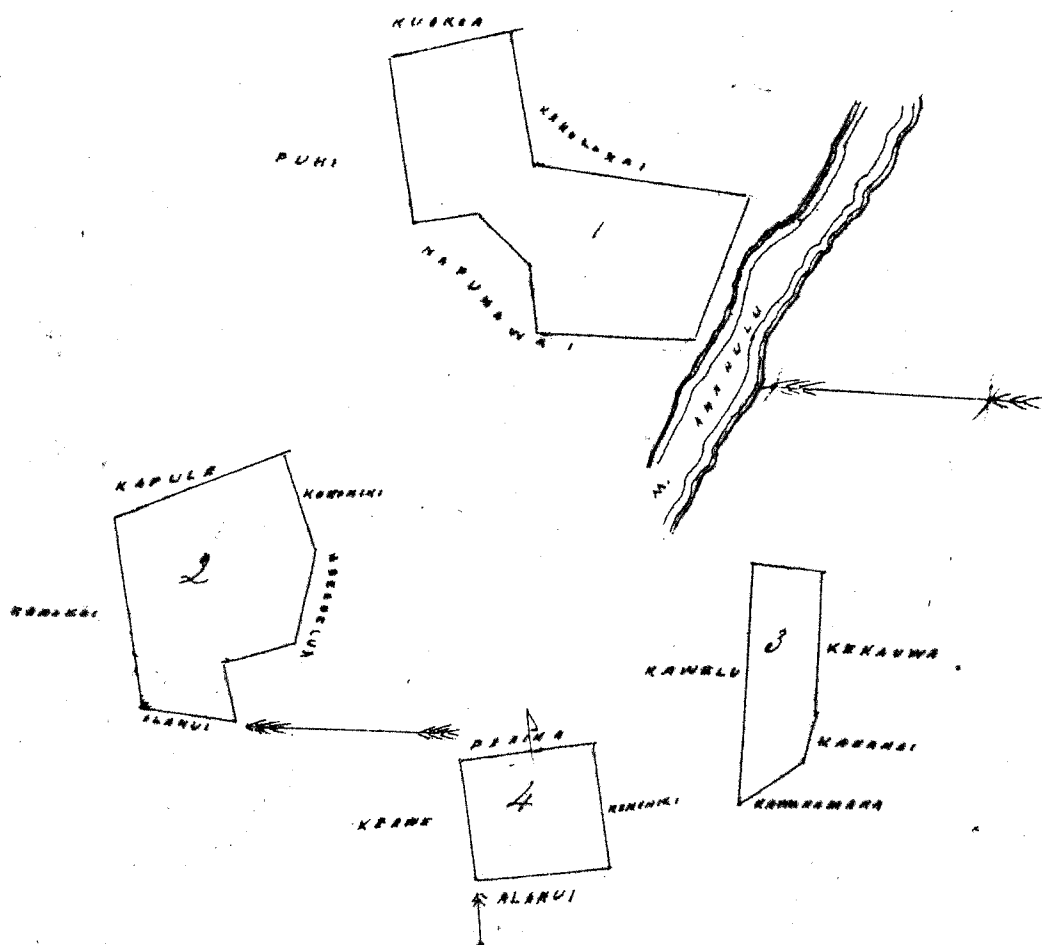

9
4
18
21
1.78

Waialua ke Apama 3
ma ke Konoiki

Apama signed
by the Board
I above signed
no known authority
J. S. Emerson

Wku Pau Loa #6

W. H. P.

J. H. Smith
J. Kekaulahao
G. M. Robertson

Honolulu 16 Aug 1852

Kole 2474 Kapule

Kawailoa Waialua Oahu

Ke Kapule no Laohulu, Hulaana ma Kawailoa Waialua Hoemaka ma ke Kiki Konoiki o ke Laanui
Lai, a ma ke Pahi Kiki Kiki Akau, holo hem 29 1/2° Ke 140 Kaul ma ke Pahi holo Ak 7° Ke 140 Kaul
ma ke Konoiki, holo Ak 1° Ke 102 Kaul ma ke Kelauna, holo Ak 40° Ke 80 Kaul ma ke
Pahi auwai, holo Ak 6 1/2° Ke 200 Kaul i ke Laanui i ke Pahi mua Area 0.54 Eka

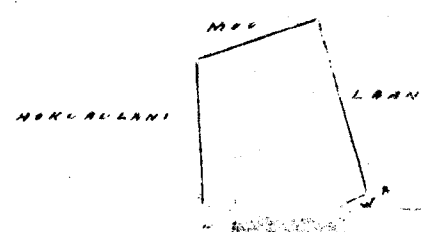

Waialua July 22 1852

J. S. Emerson,
Mea ana

Uku Pau Loa # 4

W. M. Robertson
J. H. Smith
J. Kekaulahas

Honolulu 16 Aug 1852

Walu 2849 Kaanana

Waialua Oahu

Ke Kaanana mau aina

Aia 1. ma Moomukuhue hoomaka ma ke Kahawai, ma ka pohaku L holo ke 88 ke 688
hau ma ke Kahawai, holo $14\frac{1}{2}$ hi 400 ma ke Kalua, holo Ak 64 ke 380 ma ka pali holo
Ak 34 ke 300 ma ka pali i ke kahi mua. Area 1.5 Eka

Apana 2, hoomaka ma ke kahi hoomaka ma ke Kalua, holo Ak 65 ke 150 ma
ke Kahawai, holo hui 9 ke 100 ma ke Pua, holo hui 84 ke 135 ma ka pali, holo Ak 18 ke 350
ma ke Kalua i ke kahi mua, Area 0.4 o ka Eka.

Apana 3 Ka hua hale ma Puna hoomaka ma ka pohaku i hoihonaia H. ma
Kahakai holo Ak 70 ke 220 ma Konoiki holo Ak 20 ke 625 ma Konoiki holo ke 70
ke 220 ma ke hoo hana, holo hui 20 ke 125 ma ke Kahakai i ke kahi mua, Area 0.27 o ka Eka

Apana 4 Huna Apana o ka pa hui ma Uku, hoomaka ma ke kahi hui Akau
ma ke Pua ma ka pa aina holo Ak $27\frac{1}{2}$ ke 285 ma ka pa, holo ke 85 ke 580 ma Ham
area & Nana, holo hui 3 ke 240 ma ke Ka hua holo Ak 18 ke 410 ma ke Pua i
ke kahi mua, Area 1.12 Eka.

Waialua Julai 22, 1852

J. S. Emerson
ma ana

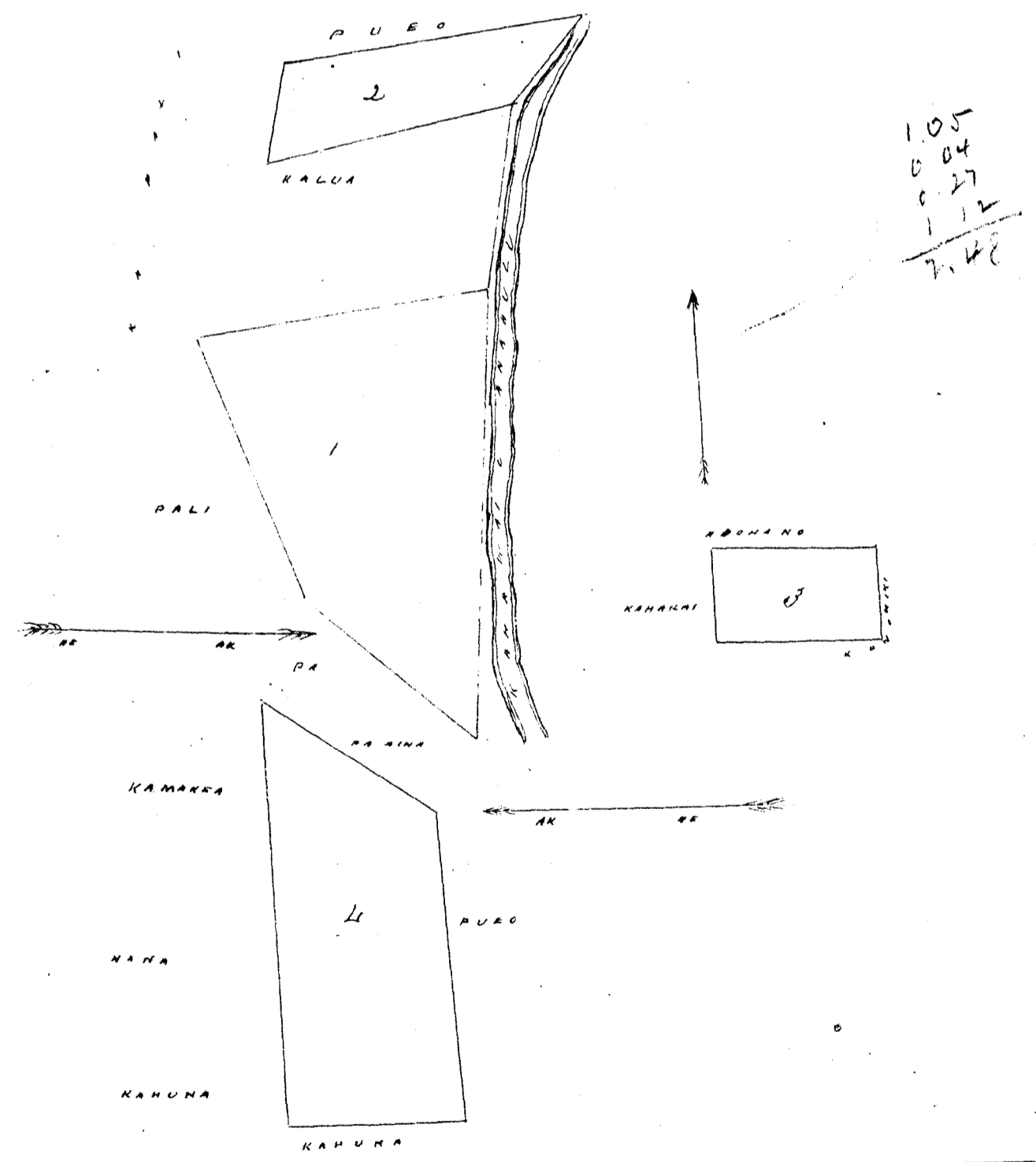

Uku Pau Loa # 6

W. M. Robertson
J. H. Smith
J. Kekaulahas

Honolulu 16 Aug 1852

Heleu 3703 Moa

Hawaitoa Waialua Oahu

Ho moe mau aina ma Hawaitoa Waialua

Apana 1. Ka Li' ma Hawaitoa Kai Homaka ma ke Kihikihi Komohane. Ke Laanui li' holo hem 62' ki 0.59 Haul ma Laanui holo he 29 1/2' ki 140 Haul ma ke Kapule, holo he 85 1/2' ki 110 Haul ma Lake, holo he 23' ki 140 Haul ma Wehuan, holo he 27 1/2' ki 97' Haul ma Komohane i ke Kihiki muna, Area 0.15 o ka Eka,

Apana 2. Hona pa hali ma Puuna Homaka ma ke Kihikihi Komohane hem a o ke Kihikihi pa hali, holo he 70' ki 220 Haul ma Kihiki holo he 20' ki 125 Haul ma ke Kihikihi holo hem 70' ki 220 Haul ma ke Komohane holo he 20' ki 125 Haul ma Komohane i ke Kihiki muna, Area 0.25 o ka Eka,

Apana 3. He Apana aina ma ke pa hui ma Uka, hem a ma ke Kihiki Komohane hem a o ke Pua, holo he 7' ki 230 Haul ma Pua, holo hem 21' ki 690 Haul. Kahuna o Hawaii holo hem 9 1/2' ki 220 Haul ma Mai o ahine holo he 80' ki 545 Haul ma Wehuan i ke Kihiki muna, Area 1.44 Eka,

Waialua July 16 1852

J. S. Emerson
Mee ana

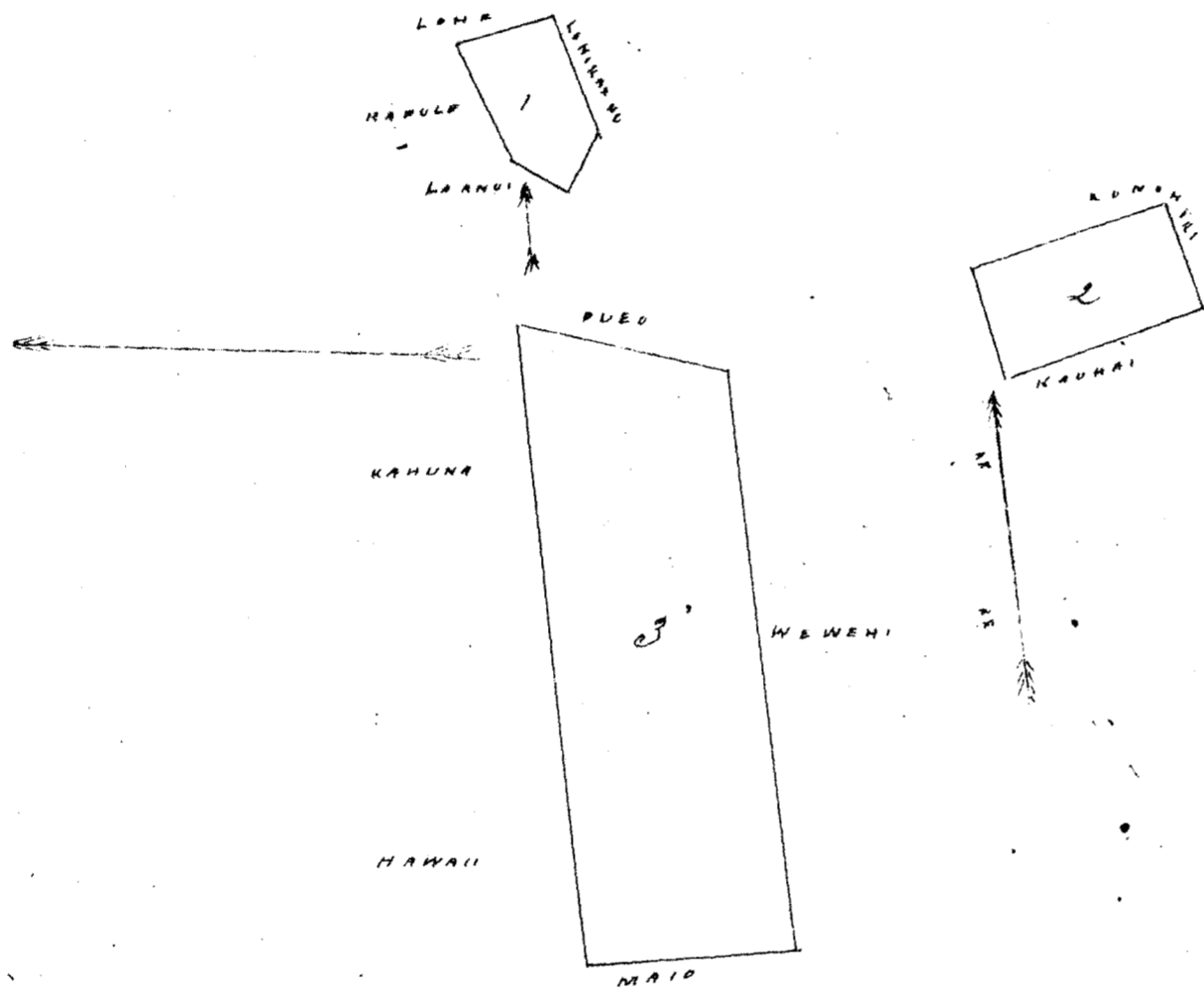

Uka Pau Loa # 6
M. L. L.

J. Kekaulahao
G. M. Robertson
J. St. L. Smith

Honolulu 16 Aug 1852

Heleu 10727 Paue

Hawaitoa Waialua Oahu

Ho Paue aina ma Hawaitoa Kai i Kapala Kahilolepe Homaka ma ke Kihikihi Komohane. Ke Kihikihi pa hali, holo he 10' ki 319 ma ke Kihikihi holo he 10' ki 276 Kapule holo he 40' ki 80 ma ke Kapule Laanui, holo he 19' ki 178 ma Laanui hem 57 1/2' ki 66 ma Laanui holo he 49 1/2' ki 446 ma Komohane i ke pa hali o Kalaimoku holo he 78 1/2' ki 372 ma ke pa hali ma ke Kihiki muna Area 0.93 o ka Eka

Waialua July 22 1852

J. S. Emerson
Mee ana

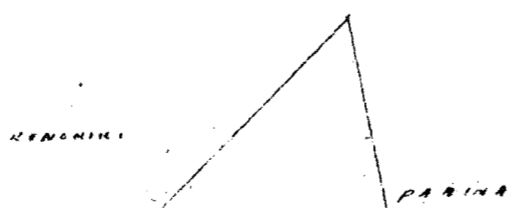

Wku Pau Loa \$4
W. H. H.

G. M. Robertson
J. H. Smith
J. M. Kaulahao

Honolulu 16 Aug 1852

Helu 1074 Wehelau

Hawaitoa Waialua Oahu

Ke Wehelau aina

1 Aina Kala ma Hawaitoa Kai Kapaia Anahulu lalo Aomaka ma
Ka aras Hem. e ka auwai, e Pupun ana i ke Pihiki Hem Akau, e ke mo aina
Holo Ak. 95° Ho, 133 Kaul ma Honohiki Ho, 50° Ho, 158 Kaul ma Honohiki Hem, 39° Ho, 0,83
Kaul ma ke Pilipi Hem, 58 1/2 Ho, 157 Kaul ma ke Pilipi Hem, 30° Ho, 140 Kaul ma Ke awe
Ak. 50 1/2 Ho, 108 Kaul ma Honohiki Ho, 18° Ho, 161 Kaul ma Honohiki Ak, 84° Ho, 212
Kaul ma Ka auwai. Kahui Ak. 21 Ho 350 Kaul i ka auwai, i ke Pihiki mua
Area .85 o ka Eka.

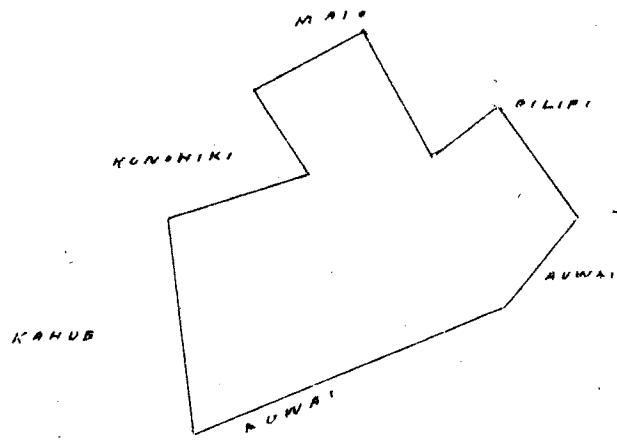

July 30 1852

J. S. Emerson
Mea ana

Wku Pau Loa \$4.00
W. H. H.

J. H. Smith
J. M. Kaulahao
G. M. Robertson

Honolulu 16 Aug 1852

Helu 2743 Pilipi

Hawaitoa kai Waialua Oahu

Ke Pilipi man aina ma Hawaitoa kai Waialua

Aina 1. Aomaka ma ke Lohu Pihiki Hiki, Hem, Holo Hem, 86 1/2 Ho, 151 Kaul ma Ka auwai,
Holo, Ak, 15° Hem, 121 Kaul ma ke Kaauwa, Holo Hem, 74° Ho, 150, Kaul ma Hokuwauani,
Holo Hem, 21° Ho, 155 Kaul, ma ke Lohu, Area, 0, 126 o ka Eka,

Apana 2. Aina pa hali a hu mau Ii Hawaitoa Kai Aomaka ma ka pahu
Pihiki Hiki, Hem, e ke Kahalau aina, Holo, Ho, 55° Ho, 130 ma Ka auwai Holo Hem, 50°
Ho, 126 ma ke Honohiki Holo Ho, 30° Ho, 0,68 ma ke Honohiki Holo Ak, 87° Ho, 128 ma ke
Honohiki Holo, Hem, 35° Ho, 0,80 ma ke Honohiki Holo Hem, 55° Ho, 150 ma ke Wehelau Holo
Ak, 28° Ho, 0,92. ma ke Maia, Holo, Ak, 50° Ho, 0,58, ma ke Maia, Holo Ak, 29° Ho, 1,67
ma ke Maia Holo Ak, 43 1/2 Ho, 1,45 ma ke Kahalau i ke Pihiki mua, Area, 0,35 o ka Eka,

Apana 3. Aomaka ma ke Pihiki Honohana Hem, e ke Kahui Ii unku Hiki,
Uma o Ka auwai, Holo Ak, 14° Ho, 1,00 Kaul ma Kahue Holo Hem, 77° Ho, 226 Kaul
e ke Kahue, Holo Hem, 25° Ho, 1,00 Kaul ma ke Kahue, Ak, 74 1/2 Ho, 205 Kaul
ma ke Honohiki i ke Pihiki mua, Area 0,21 o ka Eka,
Waialua, July 30 1852

126
350
210
686 E

J. S. Emerson
Mea ana

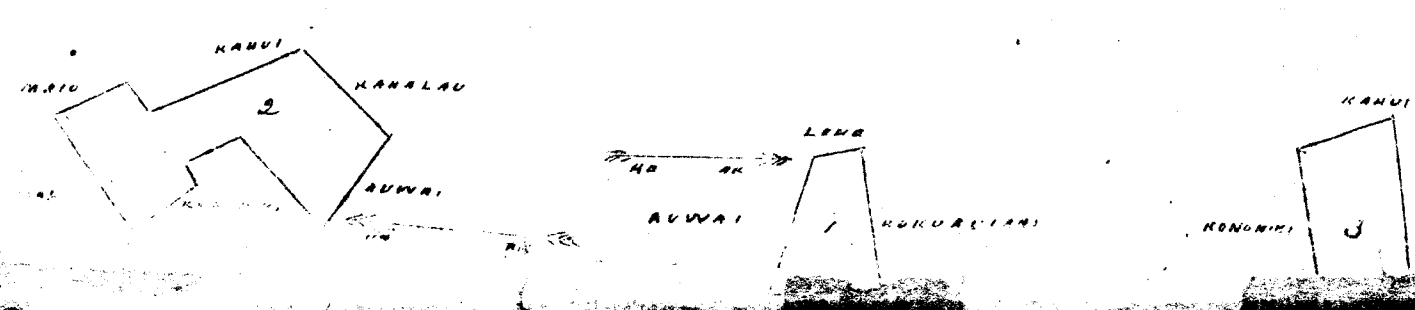

Uku

G. M. Robertson

J. Ekaulahas

J. H. Smith

Honolulu 16 Aug 1852

Heleu 2907 ~~Mokuaia~~ ~~Makuaia~~

Kawailoa Waialua Oahu

Ke Mokuaia mau aina ma Kawailoa

Apana 1. Ke kua mauka, hoomaka ma ke kua, Kihikohi, Aka, holo, hem. 39 1/2' hiki, 2,62 ma kua, holo, hem. 63, No. 289 ma hoo hano & Kaiawa, holo Aka, 1 1/2' No 285 hant ma hoo hano & Kaiawa holo Aka, 6, No. 115 ma ka pali area, 52 o ka Eka,

Apana 2. Ma Kawailoa Kai, hoomaka ma ke kua, hiki, hiki, hem. ke Puahe ke Lanui paha, pahale hua, holo, hem. 9 1/2' hiki, 3,64 hant ma ke kua hiki holo No. 84 3/4' No. 703 hant ma ke Puahe holo Aka, 1, No. 320 hant ma ke Lanui & Koiniki, holo, Aka, 8 1/2' hiki, 5,70 hant ma ke kua holo, holo Aka 3, No. 0,58 hant, ma ke kua holo, Aka, 7 1/2' hiki, 0,80 hant; ke Puahe pahale i ke kua hua Area 2 Eka,

Apana 3. Ke Mokuaia apana ma ka pa hui o Uka, hoomaka ma ke kua hiki hoo hana hem. o ke Lanui apana, holo Aka, 78' hiki, 106 ma ka pa aina holo hem. 8 1/2' hiki, 2,19 ma ka pa aina holo Aka, 7 1/2' hiki, 3,10 ma ka pa aina holo hem. 73' No. 410 ma ke kua holo hem. 2 1/2' hiki, 2,00 ma ke Lanui i ke kua hua area 8,80 o ka Eka,

Waialua, July 9, 1852

J. S. Emerson,
Mea ana,

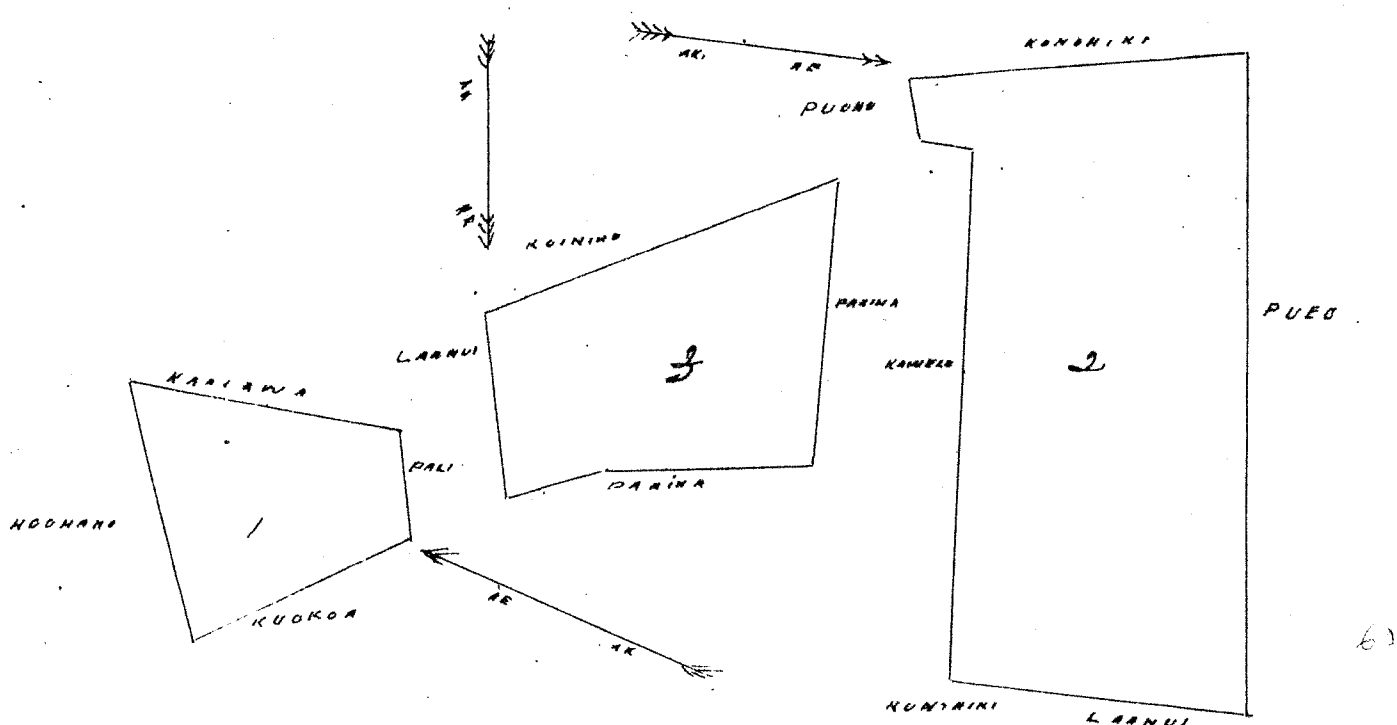

Uku

G. M. Robertson

J. Ekaulahas

J. H. Smith

Honolulu 16 Aug 1852

Heleu 7374 Kapule

Punenui Kawailoa Waialua Oahu

Ke Kapule ma Punenui aina

Apana 1. Kona mau Lanui ma Kua Kawailoa kai, hoomaka ma ke kua hua Kihikohi hoo hana hua, o kua pahale, holo, hem. 10' hiki, 2,16 ma Puahe holo Aka, 65 1/3' hiki, 1,37 ma ke kua apana 2 holo Aka, 16, No. 0,58 ma ke kua hua hua, holo Aka, 72, hiki, 90, ma ke kua hua hua holo Aka, 27, No. 20, ma ke kua hua hua, holo Aka, 27, No. 185 ma ke kua hua holo hem. 70, No. 16 ma ke kua hua, i ke kua hua, Area 0,45 o ka Eka,

Apana 2. Ma Kawailoa Kai, hoomaka ma ke kua hua Kihikohi hoo hana, Aka, hiki, Aka, 57 1/2' hiki, 0,67 ma Kua hua, holo Aka, 16, No. 198 ma Lanui holo ke 6 1/2' No. 1,00 ma ke kua hua hua, holo Aka, 28' hiki, 2,00 ma ke kua hua, i ke kua hua Area 1,2 Eka,

Apana 3. Kona Pahale, ma Paimenui Hoomaka, ma ko Lole, Kihī Kom. Akau, Holo, Hem. 61° Ki 132 ma ko Lole, Holo, Ak. 33 1/2 Ki, 166 ma ko pa aina Holo Ak. 54 1/2 Ki, 113 ma ko Kii pahale, Holo, Hem. 44, Ki 181 ma ko pa i ke Kihī mua Area 0, 21. 0 ka Eka

Apana 4. Kona Pa uwala ma Paimenui Hoomaka ma ke Kihī Kom. Ak. 0 ke Kii pa uwala, Holo Ak. 43 1/2 Ki, 266 ma ko pa aina Holo Hem. 51, Ki 673 ma ko Konoiki, Ki. Holo Hem. 54 1/2, Ki, 412 ma ko Konoiki Holo Ak. 38 1/2 Ki, 570 ma ko Kii i ke Kihī mua, Area 2, 4 Eka.

July, 22, 1852,

J. S. Emerson,
Ma ana;

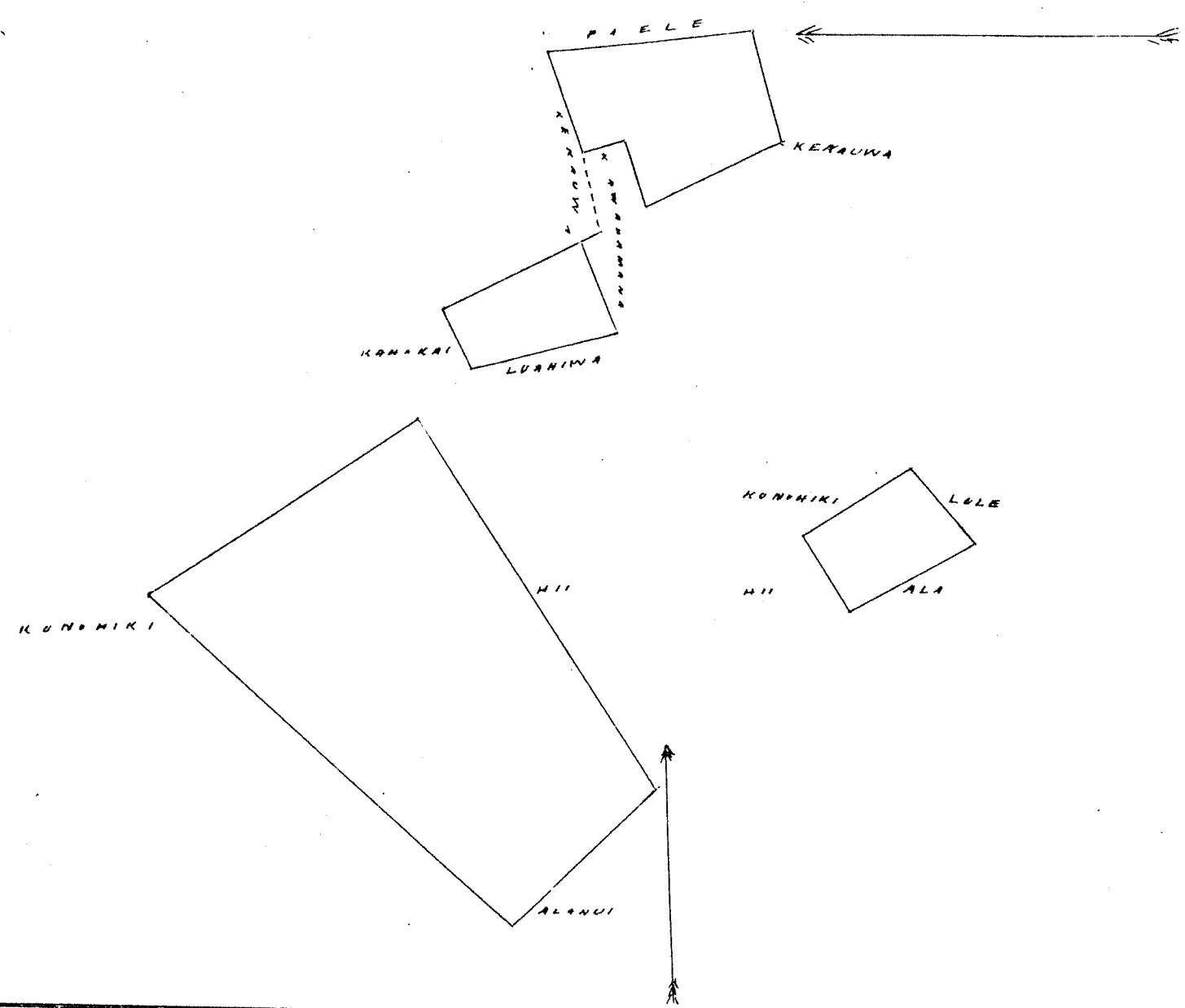

Wm Pau Lee & Co
Ma ana

J. S. Spick
J. Kekaulahas
G. M. Robertson

Honolulu 16 Aug 1852

Hole 2811 Kahui

Kaawailoa Kaiakua Oahu.

Ke Kahui mau aina ma Kaawailoa Kai,
1 Kona Kahualale, Hoomaka ma ka laau wani. Inia ma ko maia aina Holo Ak. 22, Ki, 286 Kaul ma Kahualau, Holo Ak. 48, Ki, 132 Kaul ma ka auwai Holo Hem. 23, Ki, 123 Kaul. ma ko Pilipi Holo Ak. 67 Ki 124 Kaul, ma ko maia i ke Kihī mua, Area 0, 12 Eka

Apana 2, Kona aina Kale ma Kaawailoa Kai, Hoomaka ma ke Lole Kihī Kom. Hem. Holo Hem 84° Ki 2, 32 Kaul ma Mēhulan (motu i ka auwai) Holo Hem. 81 1/2 Ki, 0, 77 Kaul ma Konoiki; Holo, Ak. 44, Ki, 121 Kaul ma Konoiki Holo Hem 63 1/2 Ki, 0, 68 Kaul ma Maia, Holo Ki, 15° Ki, 165 ma ko Maia, Holo Hem. 80° Ki 0, 24 Kaul, ma ko Maia Holo, Hem 29° Ki, 2, 31 Kaul ma ko Kealainana ma, Holo Hem. 77, Ki, 125 Kaul ma ke Fuleik Holo Hem. 86, Ki, 140 Kaul ma ko Konoiki Holo Ak 25, Ki, 231, Kaul ma Konoiki ma Pilipi Holo Ak. 77, Ki 2, 26 Kaul, ma ko Pilipi Holo Hem. 44, Ki 100 Kaul ma ko Pilipi Holo Ak. 60° Ki, 110 Kaul ma ke Kūhūhūhūhū, Holo Ak. 22 Ki, 30, Kaul ma ka auwai, Holo Ak. 46 1/2 Ki, 88 Kaul ma wauna. ka auwai i ke Kihī mua, Area 0, 81 Eka

Kaiakua July 30 1852,

J. S. Emerson
Ma ana

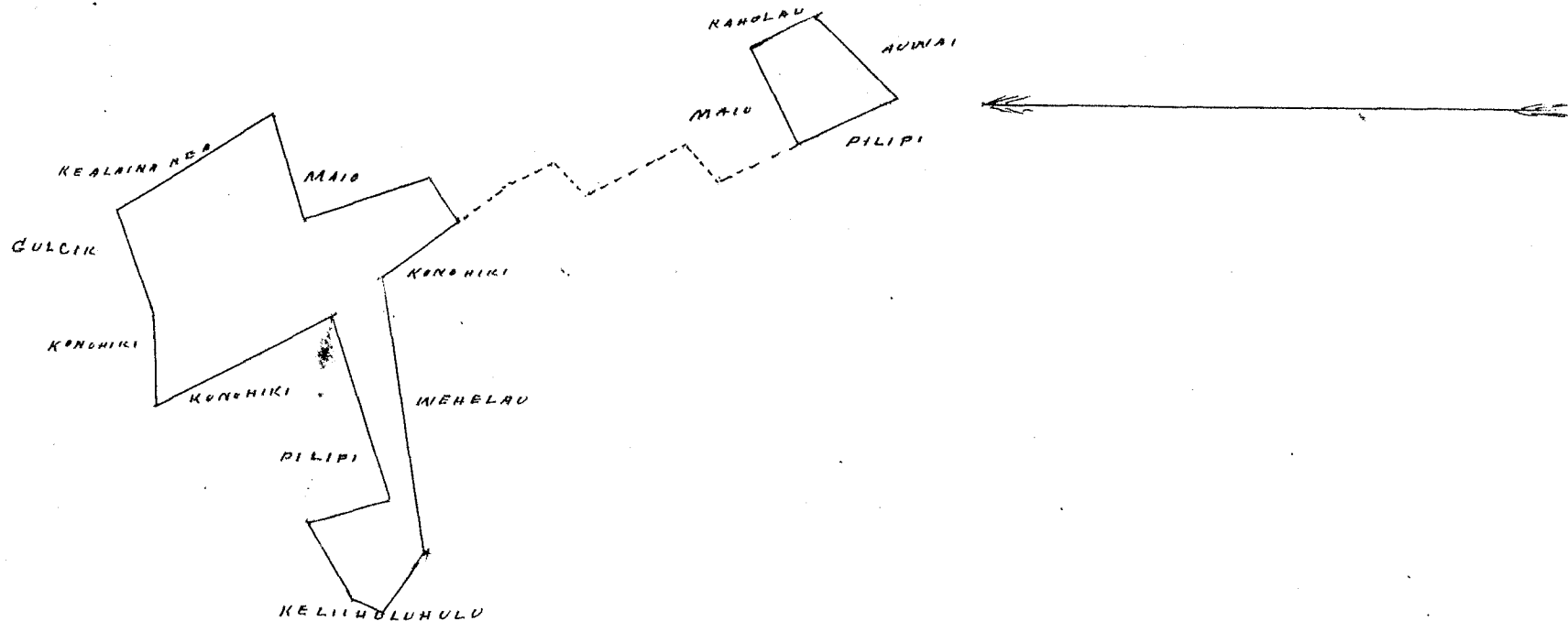

Wku Pau Lea # 4
W.H.S.

G. M. Robertson
J. H. Smith
J. Kaulahao

Honolulu 16 Aug 1852

Kolu 7408 Kawahamana

Kawailua Waialua Oahu

Ke Kawahamana, Kuleana ma Kawailua Kai

Apana 1. Kona pa hale ma Loi; Kona ma ma Kei laau, Ka ma ma Inia, ma Ke Kiki Kikina
Akan, Kolo. Kei 7' Ke 0.88 ma Ke Konoiki; Kona pa, Kolo. Kei 7' Ke 0.62 ma Ke Konoiki Kolo. Kei 7' 6"
Kei 1.25 ma Ke Lanani pa hale, Kolo. Kei 7' 6" Kei 0.76 ma Ke Lanani pa hale, Kolo. Kei 8' 6" Kei 1.62
ma Ke Kowale, Kei 3 1/2' Kei 0.80 ma Ke Lanani, Kei 3 1/2' Kei 0.76 ma Ke Kahaikai, Kolo
Kei 7' 0" Kei 2.43 ma Ke Kahaikai, Kei 1' Kei 0.19 ma Ke Kahaikai, Kolo. Kei 8' 7" Kei 1.13 ma Ke Konoiki
Kei Ke Kiki mua, Area 0.59 o ka Eka,

Apana 2. ma Loi ma Kawailua Kai, Kona ma ma Ke Lanani Kiki. Kei. Akan, Apana 1
Kolo 7' 1/2" Kei 1.06 Kaul ma Ke Kapule, L. Apana, 2. Kolo. Kei 5 1/2' Kei 0.56 Kaul ma Ke Kahaikai, Kolo
Kei 7' 8" Kei 1.19 Kaul ma Ke Kahaikai, Kolo. Kei 16' Kei 0.58 Kaul ma Ke Kapule, P. 2. Kolo. Kei 7' 2"
Kei 0.90 Kaul ma Ke Kapule P. 2. Kolo. Kei 27' Kei 0.20 Kaul ma Ke Kapule P. 2. Kolo. Kei 67'
Kei 1.27 Kaul ma Ke Kapule P. 2. Kolo. Kei 39' Kei 1.26 Kaul ma Ke Konoiki i Ke Kiki mua
Area 0.19 o ka Eka,

Waialua, July 28, 1852

J. Emerson
Ma ana.

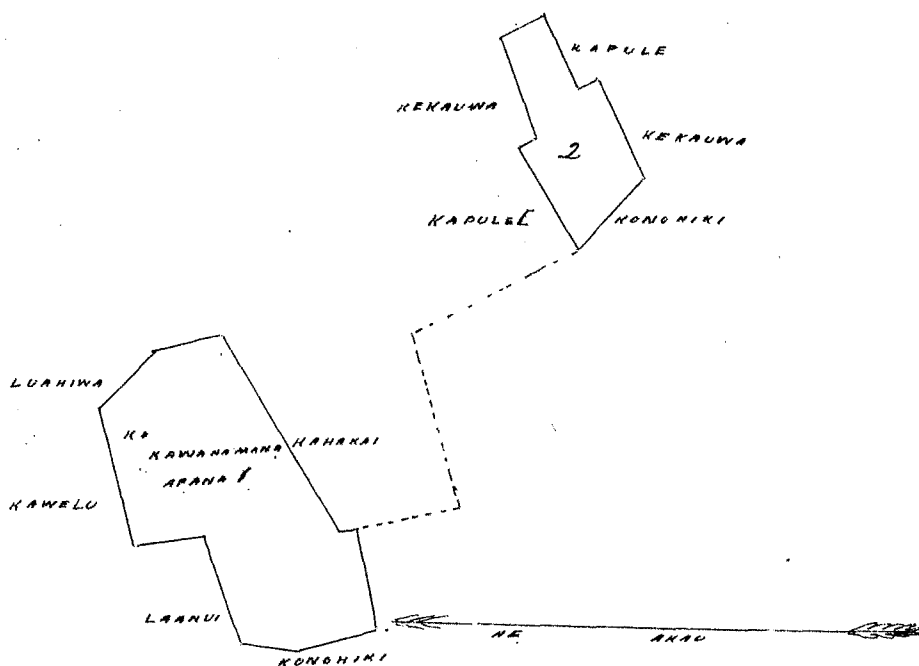

Wku Pau Lea # 5

W.H.S.

J. Kaulahao
G. M. Robertson
J. H. Smith

Honolulu, 16 Aug 1852

Hele 2926 Kahakai

Kawailua Waialua Oahu

Ke Kahakai o mau aina o Kawailua o Uka Waialua Oahu,

Apana 1. Kona Pahale o Uka, Noomaka ma ke Piki Kom. Hem. o ke Nauahi pahale
Holo Hem. 27, Ni. 0,62 ma ke alanui, Holo, Hem. 46, Ni. 1,64 ma ke alanui Holo Ak. 52, Ni. 0,34
ma Lopane, Holo Ak. 18, Ni. 1,44 ma ke Lopane, Holo Ak. 69 1/2 Ni. 0,86 ma ke Nauahi i ke
Piki mua. Area 0,08. o ka Eka.

Apana 2, ma ka pa hui o Uka, Noomaka ma ke Piki Kom. Akau, o Kawili ma
Holo Ak. 73, Ni. 4,60 ma ke Kawili ma, Holo Ak. 17 1/2 Ni. 1,25 ma ke Koiniko Holo Ak. 76
Ni. 4,34 ma ke Kolikoli Holo Ak. 7 1/2 Ni. 1,40 i ka pa aina i ke Piki mua. Area 578 Eka

Apana 3. Ma ka pa hui, Uka o, Noomaka ma ka pa Piki Nihina Ak. o ke Paia
Holo, Hem. 17, Ni. 5,87 ma Paia Holo Hem. 35, Ni. 2,26 ma ke Kealohai, Holo Ak. 85, Ni. 1,70
ma ke Kaamana, Holo, Ak. 18 1/2 Ni. 8,54 ma ke Kana & Nawahi, i ke Piki mua
Area, 2, 006 Eka

Apana 4, aina kato o Anahulu Kai, Noomaka ma ke alanui Piki Nihina,
Hema, o ke Luahiwa Holo Hem. 83, Ni. 2,07 ma ke Luahiwa Holo Hem. 59 1/2, Ni. 0,67 ma ke Ka-
pule, Holo Hem. 3, Ni. 2,94 ma ke Kekaawa, Holo Hem. 75, Ni. 0,46 ma ke Luahiwa Apana 2,
Holo Ak. 3 1/2 Ni. 0,76 ma ke Kawahamana Ak. 70, Ni. 2,43 ma ke Kawahamana
Holo, Ak. 3 Ni. 1,28 ma ke Kawahamana i ke Piki mua, Area 0,39 o ka Eka,

Waialua July 22, 1852.

J. S. Emerson
Ma ana,

80
578
2,006
390
3,154

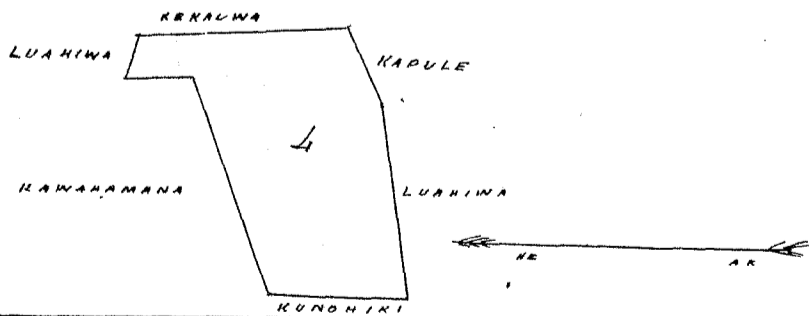
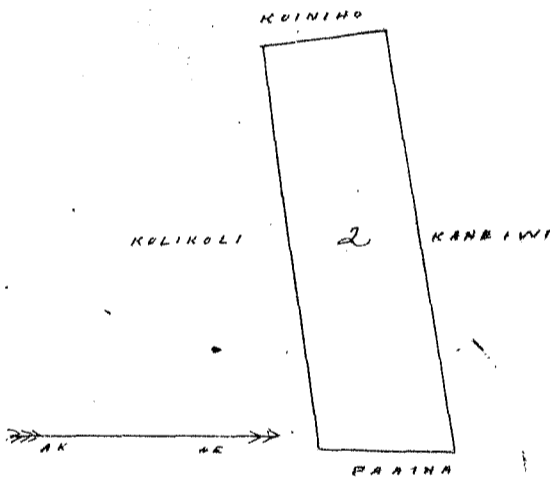
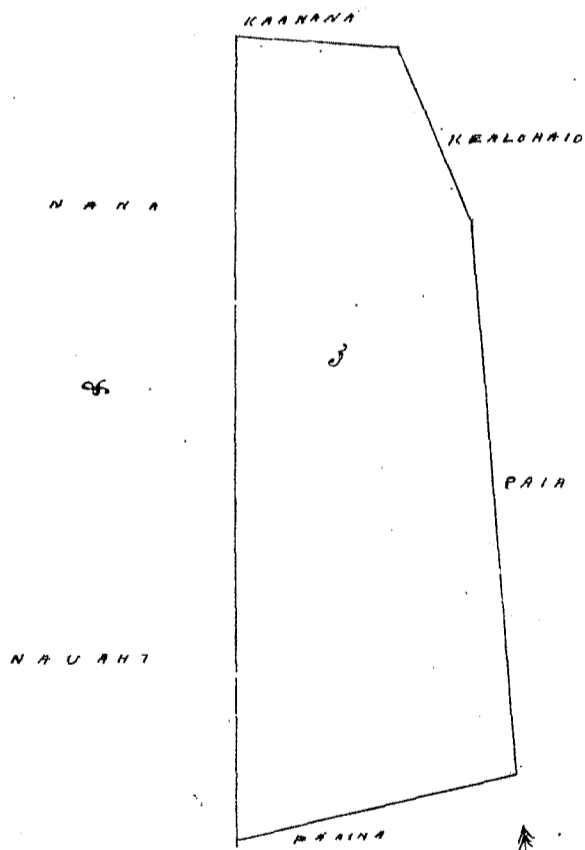

Uka Pau Loa # 6
W. H. Lee

J. Kekaulahao
G. M. Robertson
J. H. Smith

Honolulu, 16, Aug, 1852.

Ko *Kaukaiu* ma'u aina ma *Waialua*
 Apana 1 *Hoona* ma *Ke*, *Kealainanea* *Piki* *Hoona* *Ke*, ma *Ka* *pa* ma *Lauhulu*
 Holo *Ke*, 6 1/2 *Ke*, 11.70 *Ke* ma *Ke* *Kealainanea* Holo *Ke*, 19 *Ke*, 180 *Ke*, ma *Ka* *pa*, Holo,
Ke, 5 1/2 *Ke*, 11.60 *Ke* ma *Ke* *Hoona* Holo *Ke*, 23 1/2 *Ke*, 268 *Ke* ma *Ka* *pa* i *Ke* *Piki* ma'u
 Area o, 57 *Ke*, 12.57 *Ke* ma'u *Ke* *Ke* *Ke*

Apana 2. *Ke* ma *Punaka* *Hawaii* *Ke*; *Hoona* ma *Ke* *Kealainanea* *Piki*
Hoona *Ke*, Holo, *Ke*, 6 1/2 *Ke*, 11.79 *Ke* ma *Ke* *Kealainanea* Holo *Ke*, 19 3/4 *Ke*, 266 *Ke*
 ma *Ke* *Hoona*; Holo *Ke*, 51 *Ke*, 1.67 *Ke* ma *Ke* *Kealainanea*; Holo *Ke*, 31 *Ke*, 150 *Ke* ma *Ke* *Hoona*;
 Holo *Ke*, 29 3/4 *Ke*, 156 *Ke* ma *Ke* *Kealainanea*, Holo *Ke*, 6 1/2 *Ke*, 135 *Ke* ma *Ke* *Kealainanea*, i
Ke *Piki* ma'u, Area o, 513 o *Ke* *Ke*,
Waialua *Ke* 30, 1852

J. S. Emerson,
 Ma'u ma'u.

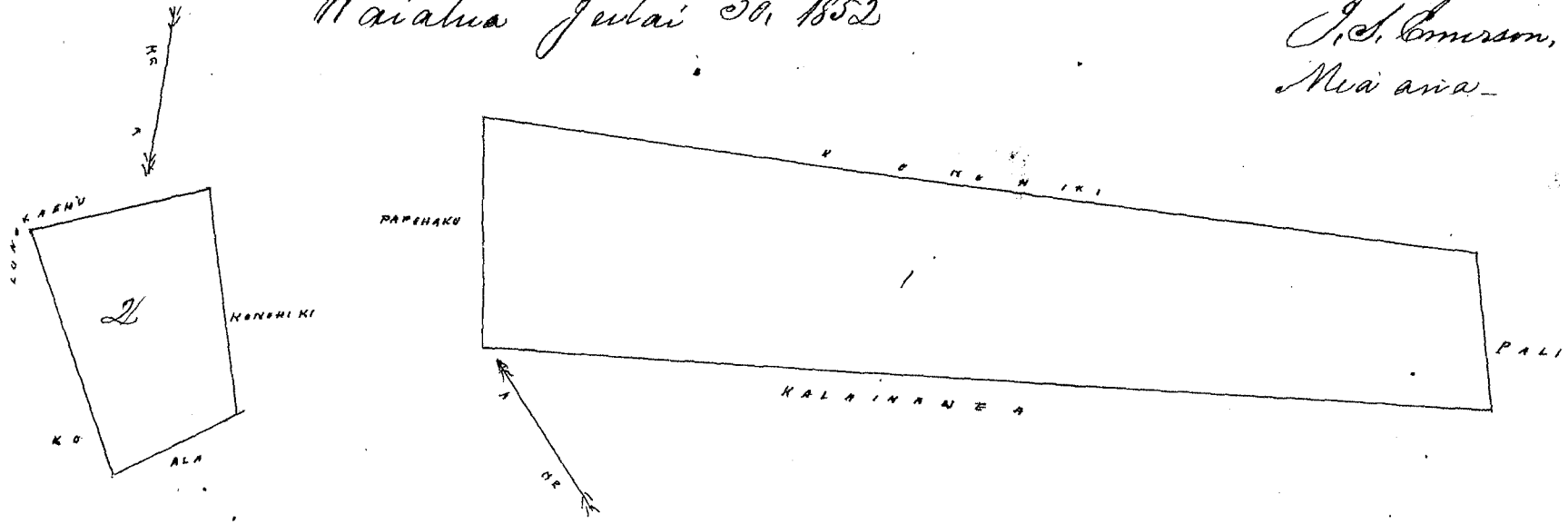

Ke *Ke* *Ke* 6
Ke

J. Kekaula
 G. M. Robertson
 J. H. Smith

Ke, 16, Aug. 1852.

Ko *Kealainanea* aina ma *Waialua*
 Apana 1. *Ke* ma *Kealainanea* ma *Kealainanea* *Piki* *Ke*,
 Holo *Ke*, 65, *Ke*, 12.50 *Ke* ma *Kealainanea*, Holo *Ke*, 19, *Ke*, 230 *Ke* ma *Ka* *pa*, Holo *Ke*,
 6 1/2 *Ke*, 11.70 *Ke* ma *Ke* *Kaukaiu*, Holo *Ke*, 23 1/2 *Ke*, 229 *Ke* i *Ka* *pa* *Ke*, i *Ke*
Piki ma'u, Area 4, 12 *Ke*,
Waialua *Ke* 30, 1852

Apana 2. ma *Punaka*, ma *Hawaii* *Ke*; *Hoona* ma *Ke* *Kaukaiu* *Piki* *Ke*,
 Holo *Ke*, 23 *Ke*, 310 *Ke* ma *Ke* *Hoona* Holo *Ke*, 71 3/4 *Ke*, 344 *Ke* ma *Ke* *Kealainanea*
 Holo *Ke*, 25 *Ke*, 231 *Ke* ma *Ke* *Kealainanea*, Holo *Ke*, 13 1/2 *Ke*, 238 *Ke* ma *Ke* *Kealainanea*
 Holo *Ke*, 31 3/4 *Ke*, 158 *Ke* ma *Ke* *Kealainanea*, Holo *Ke*, 6 1/2 *Ke*, 179 *Ke* ma *Ke* *Kealainanea*
Ke ma'u, Area o, 754 o *Ke* *Ke*,
Waialua *Ke* 30, 1852

J. S. Emerson,
 Ma'u ma'u.

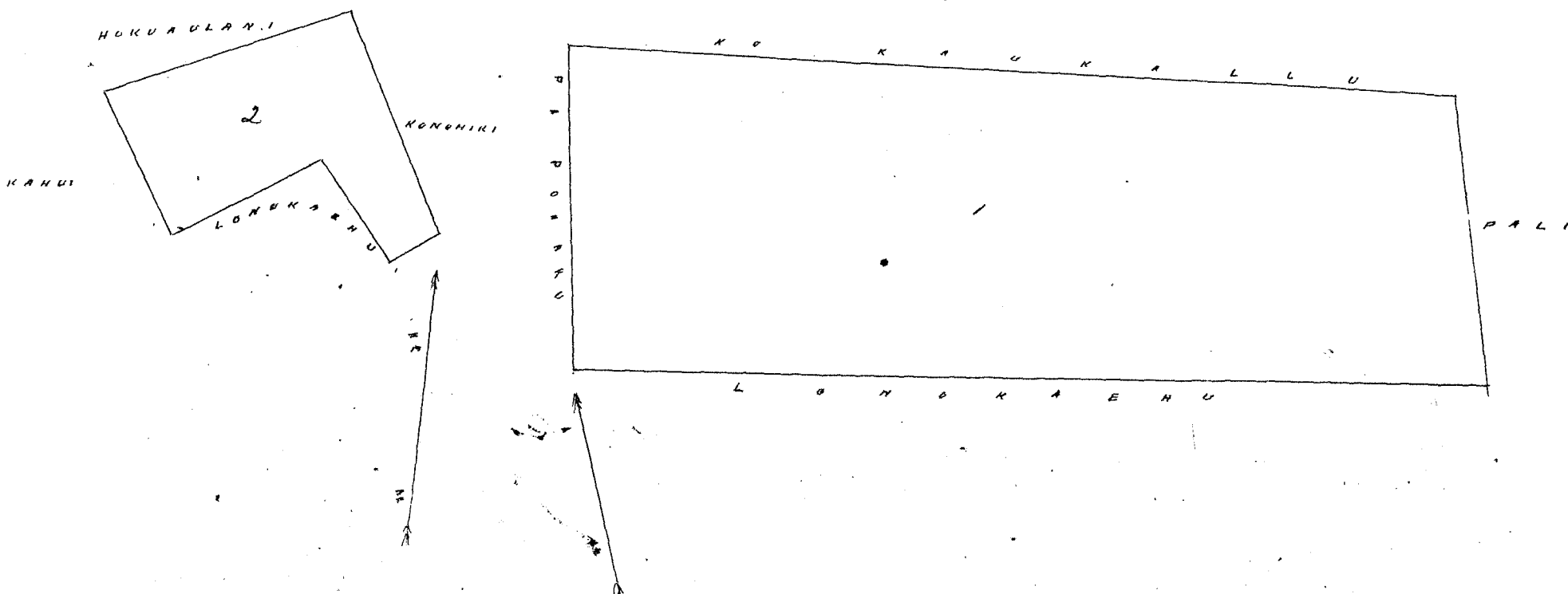

Uku Pau Loa #7
M. K. H.

J. J. Smith
J. K. Kaulahao
G. W. Robertson

Honolulu 16 Aug 1852

Hoelu 10482 Naha

Kaulahao Naha Maui

See Page 76 this volume

Naha ma Kaulahao Naha Maui

Apana 1. Naha ma Hanamulei, E hoomaka ana ma ke Kahi Aha a e holo ana
Kam. 69. Ni. 6,60 paauku e pili ana i ke Ke Konoiki Kam. 1. Ni. 182 paauku e pili ana i ke
Kaniho Ak. 73. Ni. 730 paauku ma ke Pahuaina Ak. 25. Ni. 250 paauku e pili ana i
ke Konoiki i ke Kahi mua 14/10 Eka,

Apana 2. Naha ma Hanamulei, E hoomaka ana ma ke Kahi Aha a e
holo ana, Ak. 68 1/2 Ni. 956 paauku e pili ana i ke Ke Konoiki Ak. 82 Ni. 460 paauku
e pili ana ma ke Ke Konoiki, Ak. 31 1/2 Ni. 700 paauku e pili ana i ke Pahuaina
Kam. 30 Ni. 480 paauku e pili ana i ke Konoiki Kam. 70. Ni. 860 paauku e pili ana i ke
Konoiki Kam. 13 Ni. 315 paauku e pili ana i ke Konoiki i ke Kahi mua 4 28/100 Eka,

Apana 3. Naha ma Kahi Waiaho E hoomaka ana ma ke Kahi Aha
a e holo ana, Ak. 67 Ni. 650 paauku e pili ana i ke Konoiki Ak. 23 Ni. 460 paauku
e pili ana i ke Mahopaki Kam. 70 Ni. 720 paauku e pili ana ma ke Hawaala,
Kam. 30 Ni. 508 paauku e pili ana i ke Konoiki i ke Kahi mua 3 24/100 Eka

11 Feby 1852,

A. F. Turner
Luna ana aina

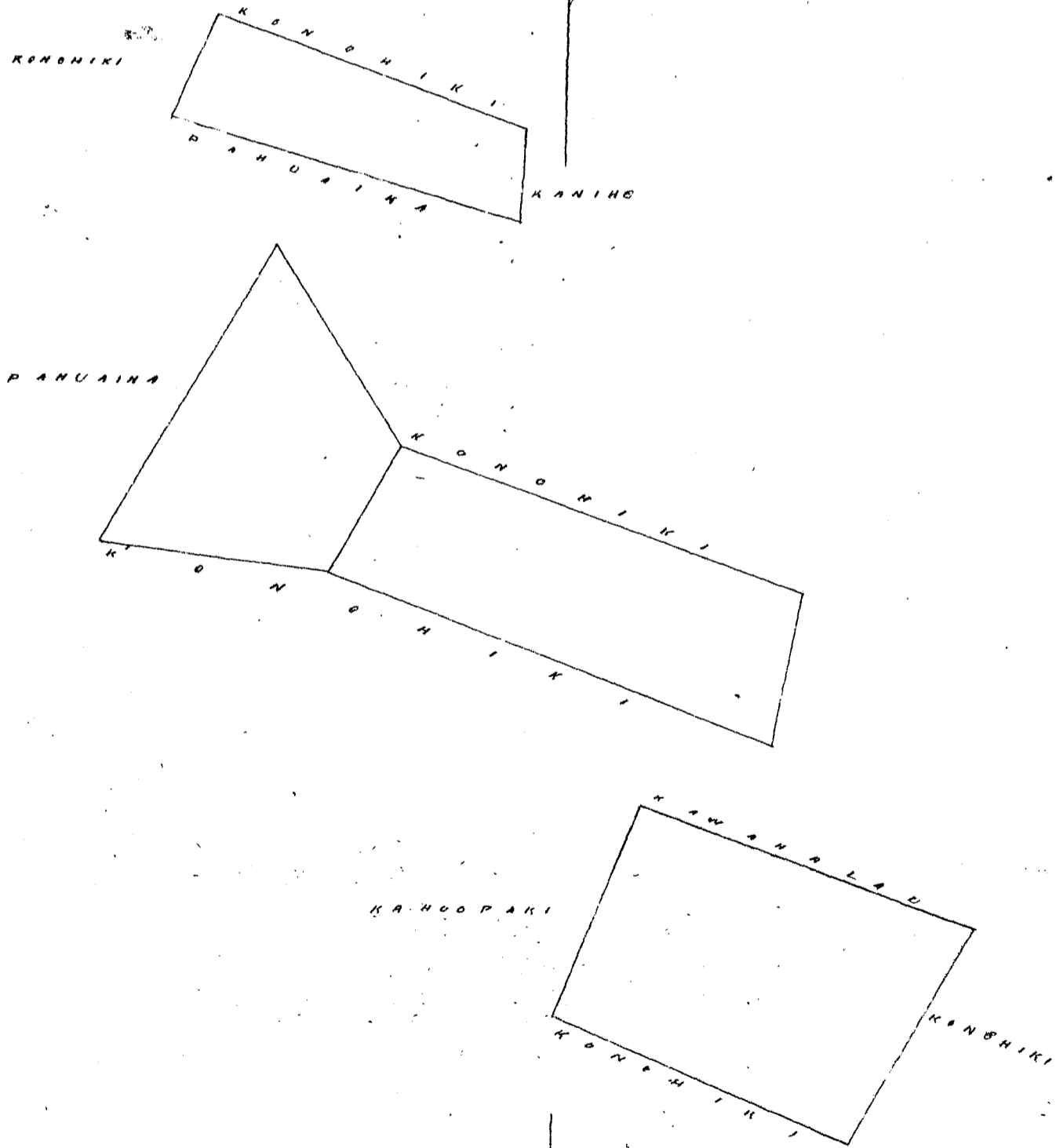

Uku Pau Loa 9.
W. H. H.
G. M. Robertson
J. H. Smith
J. Kekaulaha

Honolulu 27 Aug 1852

Hoelu 11,022 ^{W. H. H.} Mahinealii

^{W. H. H.} Waiohuli Kula Maui

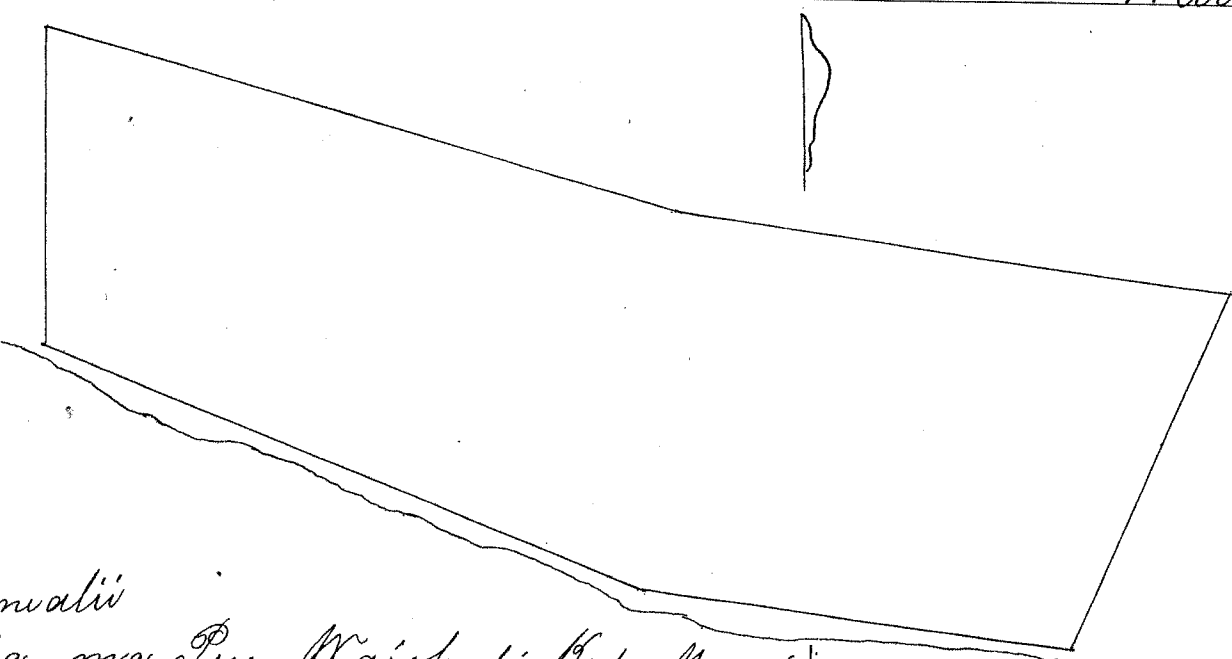

Wahinealii

Aina Kula owa Pua Waiohuli Kula Maui,
E hoomaka owa ke Kihia Akau, a e holo ana. Mem. 335 pautu e pili ana i ke ke Konohiki Sum. 69.
Ki, 685 pautu e pili ana i ke Kihia Akau, Mem. 84 Ki, 450 pautu e pili ana i ke Kihia Akau, Ak. 22 1/2
Ki, 110 pautu e pili ana i ke Pupuaka, Ak. 83. Ki, 590 pautu e pili ana owa Konohiki Ak. 75
Ki, 672 pautu e pili ana owa Konohiki i ke Kihia owa 4 1/2 Eka.

9 Feby. 1852.

A. F. Turner
Luna ana aina

P. O. 1852.

Uku Pau Loa 6.
W. H. H.
G. M. Robertson
J. H. Smith
J. Kekaulaha

Honolulu 27 Aug 1852

Hoelu 7971 ^{W. H. H.} Kahulukaai

^{W. H. H.} Waiohuli Kula Maui

Kahulukaai, owa Waiohuli Kula Maui.

Apana 1. Kula owa Ohia E hoomaka owa ke Kihia Akau, a e holo ana, Ki, 31 Ki, 110 pautu e pili
ana i ke Ohia, Ki, 56. Ki, 1285 pautu e pili ana i ke Kihia, Ak. 89 Ki, 480 pautu e pili ana owa
ke Kihia, Mem. 53 Ki, 225 pautu e pili ana i ke Kihia, Mem. 63 1/2 Ki, 350 pautu e pili ana i
ke Kihia, Ak. 2. Ki, 180 pautu e pili ana i ke Emilia Ak. 16. Ki, 200 pautu e pili ana i ke Emilia
Ak. 60 Ki, 1000 pautu e pili ana i ke Emilia Ak. 86. Ki, 620 pautu e pili ana i ke Emilia Ak. 70
Ki, 585 pautu e pili ana i ke Opulakau, i ke Kihia owa 7 3/10 Eka.

Apana 2. Kula owa
E hoomaka ana owa ke Kihia Akau, a e holo ana Mem. 17
Ki, 600 pautu e pili ana i ke Konohiki Sum. 46. Ki, 460 pautu e pili ana i ke Konohiki Ak. 73.
Ki, 408 pautu owa ke Poe, Ak. 87. Ki, 583 pautu e pili ana owa ke Poe Ak. 21 Ki, 610 pautu
e pili ana owa ke Kihia, Ak. 78 Ki, 900 pautu e pili ana i ke Konohiki i ke Kihia owa 7 4/10 Eka

4 Feby 1852.

A. F. Turner
Luna ana aina

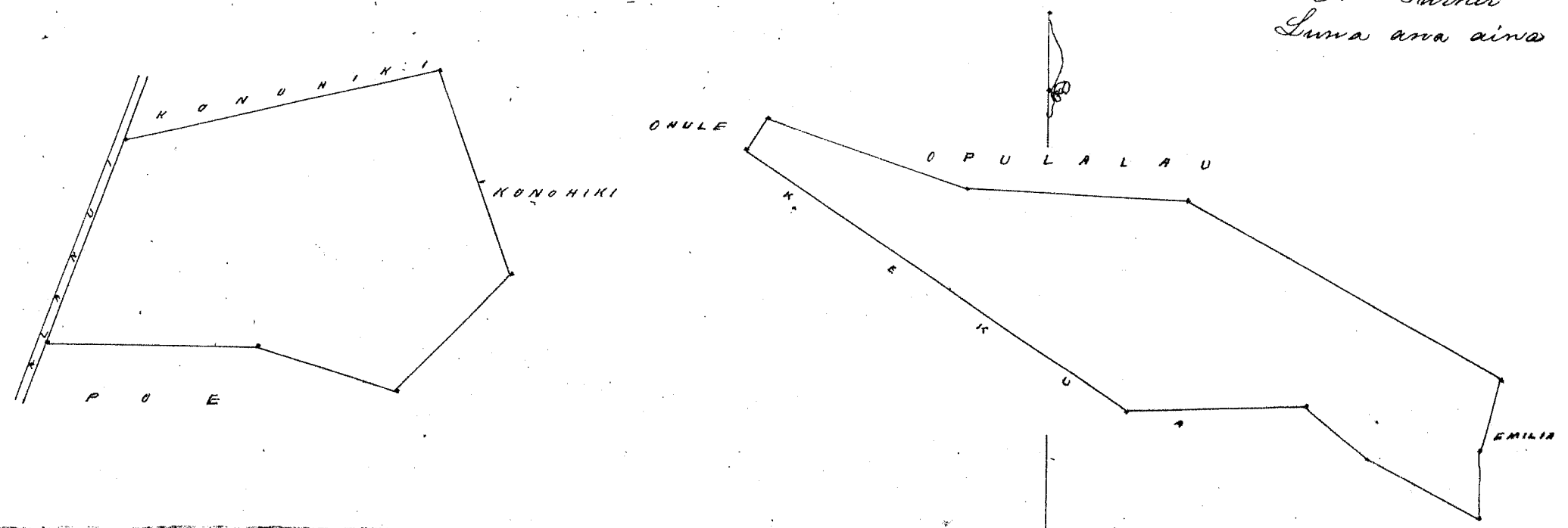

Uku Pau Loa # 11.

W. L. Lee
S. M. Robertson
J. Hekeaulahas
J. H. Smith

Honolulu 27 Aug 1852.

Heleu 6041 Eka

Waiohuli Kuba Maui

Mui Arua 17. anai.

Eka ma Waiohuli Kuba Maui

Kuba ma Waieli - E hoomaka ana ma ke Pihia Akau a e holo ana, Mem. 1/2, Ni. 330, prautu e pili ana i ke Honohiki Nema, 14° Ni, 205, prautu e pili ana me ke Honohiki Mem. 5° Ni 200, prautu e pili ana, Mem. 7 1/2° Ni, 310, prautu e pili ana me ke Puua, Mem. 6°, Ni, 294 prautu e pili ana me Puua Mem. 7 5/2° Ni, 321 prautu e pili ana, i ke Puua, Mem. 81° Ni, 442, prautu e pili ana me Hekeulahas Mem. 18° Ni, 340 prautu e pili ana i ke Opunui, Mem. 67° Ni 242, prautu ma ke Opunui, Mem. 71° Ni 520, prautu e pili ana me Opunui, Mem. 69, Ni, 600, prautu e pili ana i ke Opunui Ak. 230 prautu e pili ana i ke Mark, G. Ak. 6 7/2° Ni, 330, prautu e pili ana i ke John Richardson Ak. 60, Ni 644 prautu e pili ana i ke John Richardson Ak. 57, Ni, 275, prautu e pili ana me ke John Richardson, Mem. 60 1/2 Ni 327 prautu e pili ana me Kanaina Ak. 66 1/2 Ni, 816, prautu e pili ana i ke Kanaina Ak. 67, Ni 646, prautu e pili ana me ke Puua i ke Pihia ma 12 3/10 Eka.

A. F. Turner,
Luna ana aina.

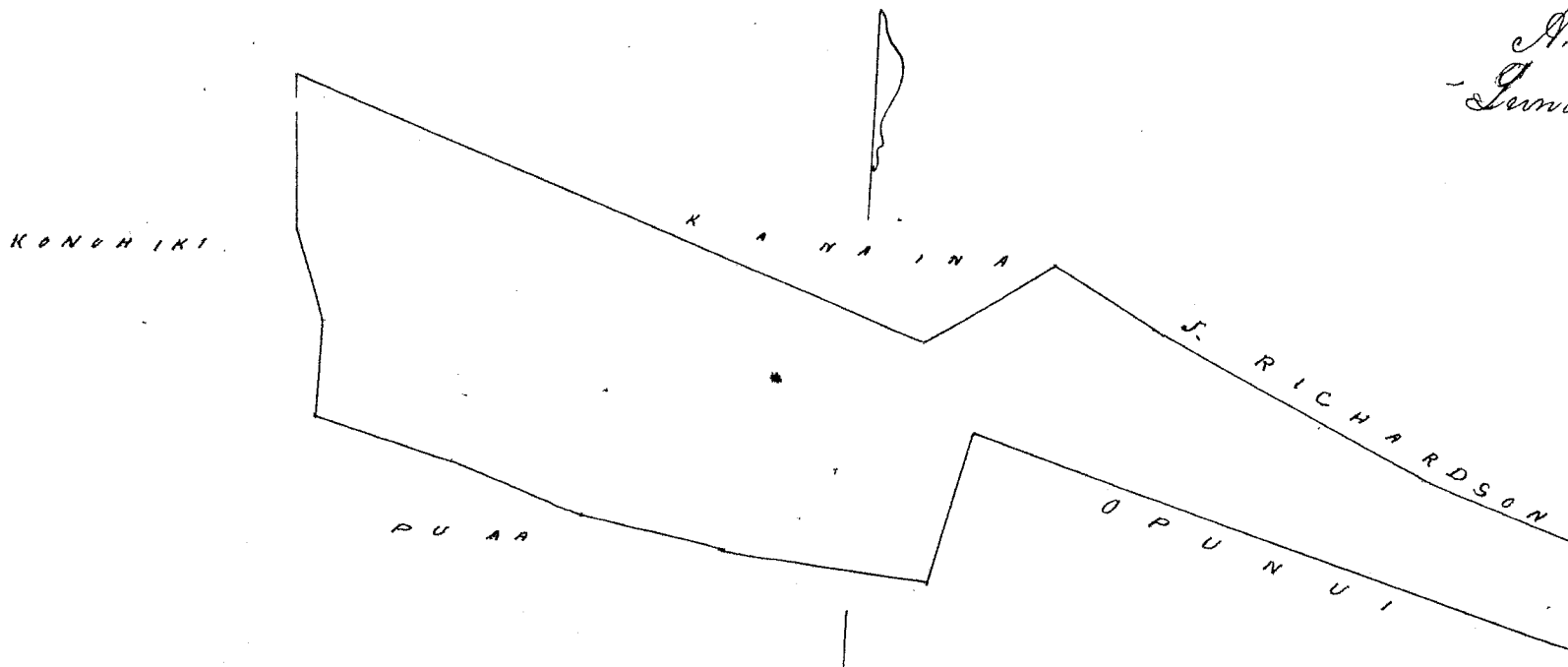

Uku Pau Loa # 10.

W. L. Lee
S. M. Robertson
J. Hekeaulahas
J. H. Smith

Honolulu 27 Aug 1852.

Heleu 4845 Eka

Waiohonu Nana Maui

Eka ma Waiohonu, Nana Ili aina o Awake Opunui & Huhahava
E hoomaka ana ma ke Pihia Hikina Ak. a e holo ana, Ak. 63, Ni 435 prautu e pili ana i ke "Makaalae," Mem. 28° Ni 80, 45 prautu ma ke alani Opunui ma ke Huhawai alaila e pili ana i ke Huhawai, ma ke Kai, alaila e pili ana i ke Kai ma ke Pihia ma 10 Eka

7 April 1852.

A. F. Turner,
Luna ana aina.

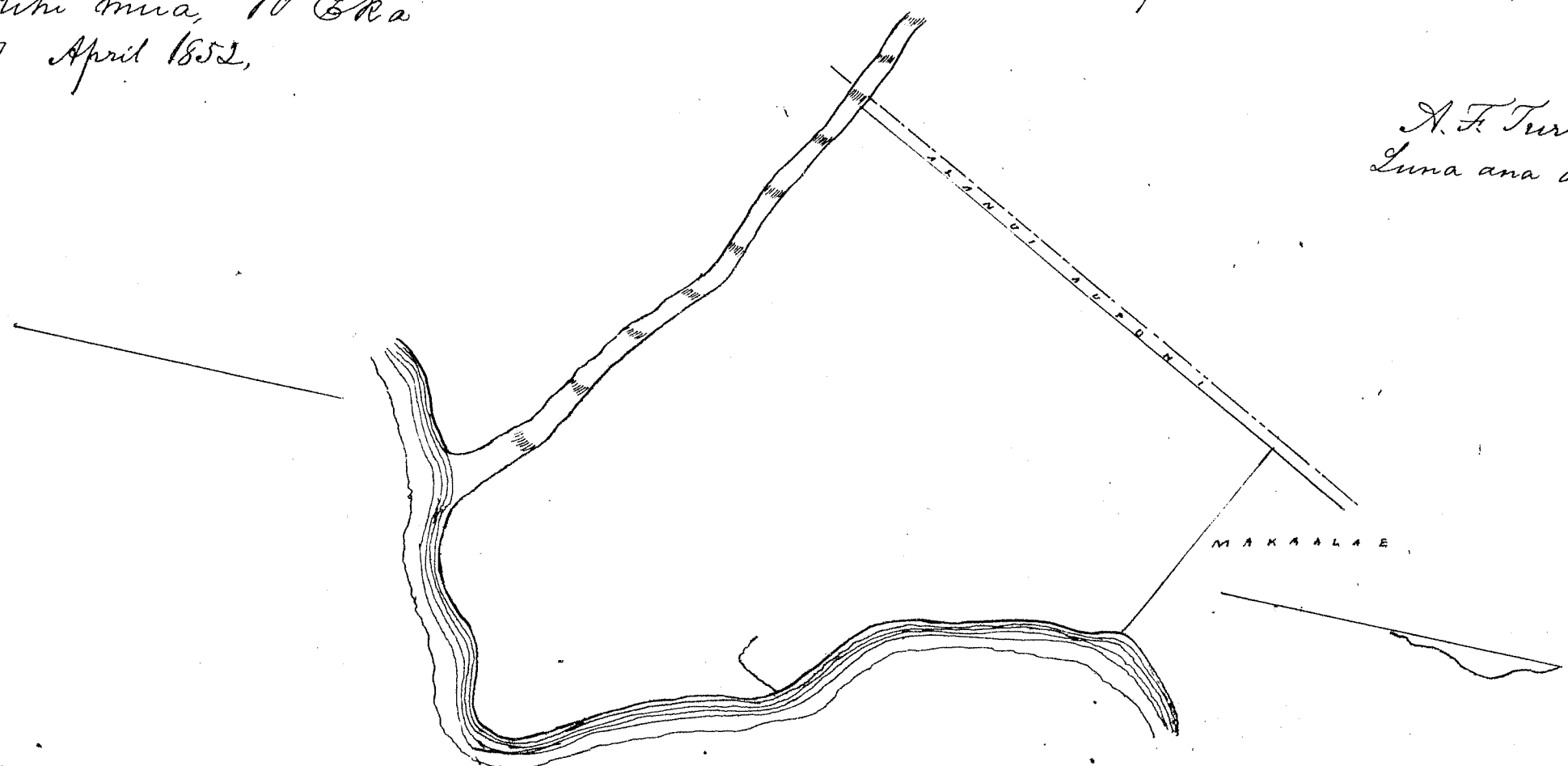

Uka Pau Loa 19.

W. L. Lee
G. M. Robertson
J. Kekaulahas
J. H. Smith

Honolulu 27 Aug 1852.

Keleu 6543 Hoopiopio

Waiokalani Kula Maui.

Apana 1. Kula ma Kohelipe E hoomaka ma ke Kihī Kema, a e holo ana, Ak 21° Ni 30 1/2 pautu e pili ana i ke Honohiki Ak, 68° Ni, 12, 50 pautu e pili ana i ke Honohiki Kem. 21° Ni, 30 1/2 pautu e pili ana i ke Honohiki Kem. 68° Ni, 12, 56 pautu e pili ana ma ke Alanui i ke Kihī ma 3 3/10 Eka,

Apana 2. Kula ma Waieli E hoomaka ana ma ke Kihī Kema, a e holo ana, Ak, 35° Ni, 25 1/2 pautu e pili ana i ke ke Honohiki Ak, 50° Ni, 4, 80 pautu e pili ana i ke Honohiki Ni, 40° Ni, 300 pautu e pili ana i ke Honohiki Kem. 55° Ni, 500 pautu e pili ana i ke Honohiki i ke Kihī ma 1 3/10 Eka,

Apana 3. Kula ma Hukuihanau. E hoomaka ana ma ke Kihī Kema, a e holo ana, Ak, 48° Ni, 400 pautu e pili ana i ke Alanui Ak, 74° Ni, 885 pautu e pili ana i ke Po, Kem. 16° Ni, 220 pautu ma ke Honohiki Kem. 63° Ni, 655 pautu e pili ana i ke Honohiki i ke Kihī ma 2 1/10 Eka,

Apana 4. Kula ma Kūpali. E hoomaka ma ke Kihī Kema, a e holo ana Ak, 2° Ni, 330 pautu e pili ana i ke Kāai, Kem. 87° Ni, 6, 60 pautu e pili ana i ke Honohiki Kem. 255 pautu e pili ana i ke Keawe, Kem. 70° Ni, 154 pautu e pili ana i ke Alanui, Kem. 88° Ni, 525 pautu. e pili ana i ke Alanui; i ke Kihī ma 1 9/10 Eka,

Apana 5. Kula ma Paiki E hoomaka ana ma ke Kihī Kema, a e holo ana, Kem. 59° Ni, 490 pautu e pili ana i ke Lūhulu, Kem. 33° Ni, 195 pautu e pili ana ma ke Lūhulu, Kem. 74° Ni, 495 pautu e pili ana i ke Lūhulu, Kem. 28° Ni, 250 pautu e pili ana i ke Honohiki Ak 68° Ni, 910 pautu e pili ana i ke Honohiki Ak 25° Ni, 470 pautu ma ke Honohiki i ke Kihī ma 3 Eka,

3. Feby. 1852.

A. F. Turner.
Luna ana aina.

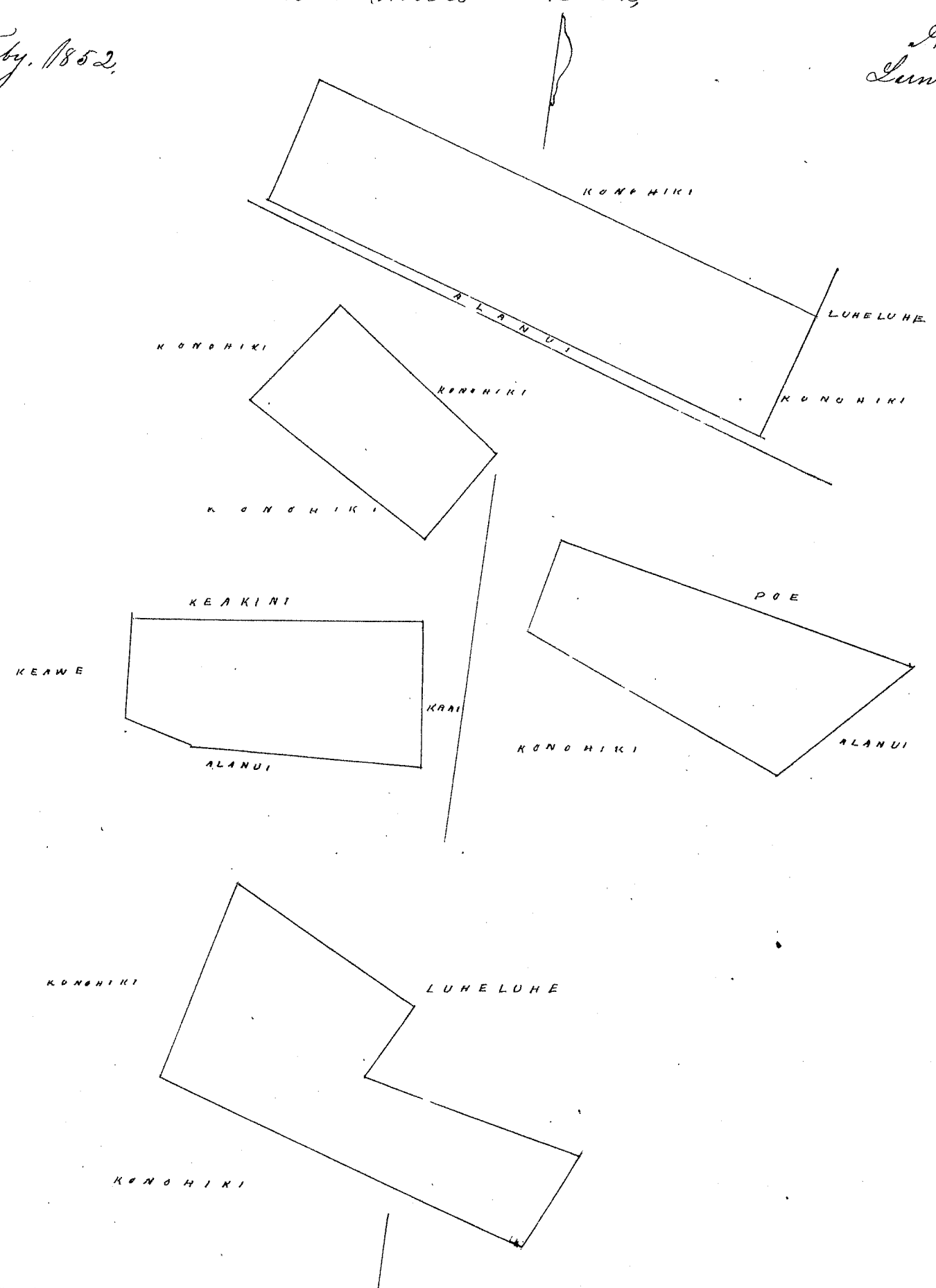

Uku Pau Loa # 10
W. L. Lee
G. M. Robertson
J. H. Kaulahao
J. H. Smith

Honolulu 27 Aug. 1852

Keleu 10144 Moakahiki

Waiakoa Kula Maui

Apama 1. Kula ma Kalihī Waiakoa E hoomaka ana ma ke Kihī Aka, a e holo ana, Num. 58' Nii, 430 pautu e pili ana i ke ke Honohiki, Num. 23' Nii, 330 pautu e pili ana i ke ke Honohiki Aka, 58' Nii, 180 pautu e pili ana i ke ke Honohiki, Aka, 10' Nii, 445 pautu e pili ana i ke ke Honohiki i ke Kihī o mua, 1 Eka

Apama 2. Kula ma Pakaka, Waiakoa E hoomaka ana ma ke Kihī Aka, a e holo ana, Num. 74' Nii, 617 pautu e pili ana i ke ke Honohiki Num. 254' pautu e pili ana i ke Honohiki; Aka, 78' Nii, 660 pautu, e pili ana i ke ke Honohiki; Aka, 10' Nii, 330 pautu e pili ana i ke Naha, i ke Kihī o mua 1 7/10 Eka

Apama 3. Kula ma Hanamuli Kealahou, E hoomaka ana ma ke Kihī Aka, a e holo ana, Num. 77' Nii, 1640 pautu e pili ana i ke Ke Honohiki Num. 2' Nii, 400 pautu e pili ana i ke Kawaula Aka, 77' Nii, 1400 pautu e pili ana i ke Pahu aia Aka, 14' Nii, 508 pautu e pili ana i ke ke Honohiki i ke Kihī o mua, 2, 87/100 Eka,

Apama 4. Kula ma Paliku Kealahou, E hoomaka ana ma ke Kihī Aka a e holo ana, Num. 67' Nii, 1243 pautu e pili ana i ke ke Honohiki Num. 20' Nii, 500 pautu e pili ana i ke Honohiki Aka, 73' Nii, 1146 pautu e pili ana, i ke Hale Pule pope, Aka, 11' Nii, 676 pautu e pili ana i ke Hale Pule pope i ke Kihī o mua 6 7/100 Eka,

Apama 5. Kula ma Hinanauaii Kealahou, E hoomaka ana ma ke Kihī Aka, a e holo ana, Num. 41' Nii, 255 pautu e pili ana i ke Kamalea, Num. 75' Nii, 330 pautu e pili ana i ke Naha, Aka, 20' Nii, 210 pautu e pili ana ma ke Honohiki Aka, 70' Nii, 210 pautu e pili ana i ke ke Honohiki i ke Kihī o mua 8 4/100 Eka,
10, Feb. 1852,

A. F. Turner,
Luna ana aina

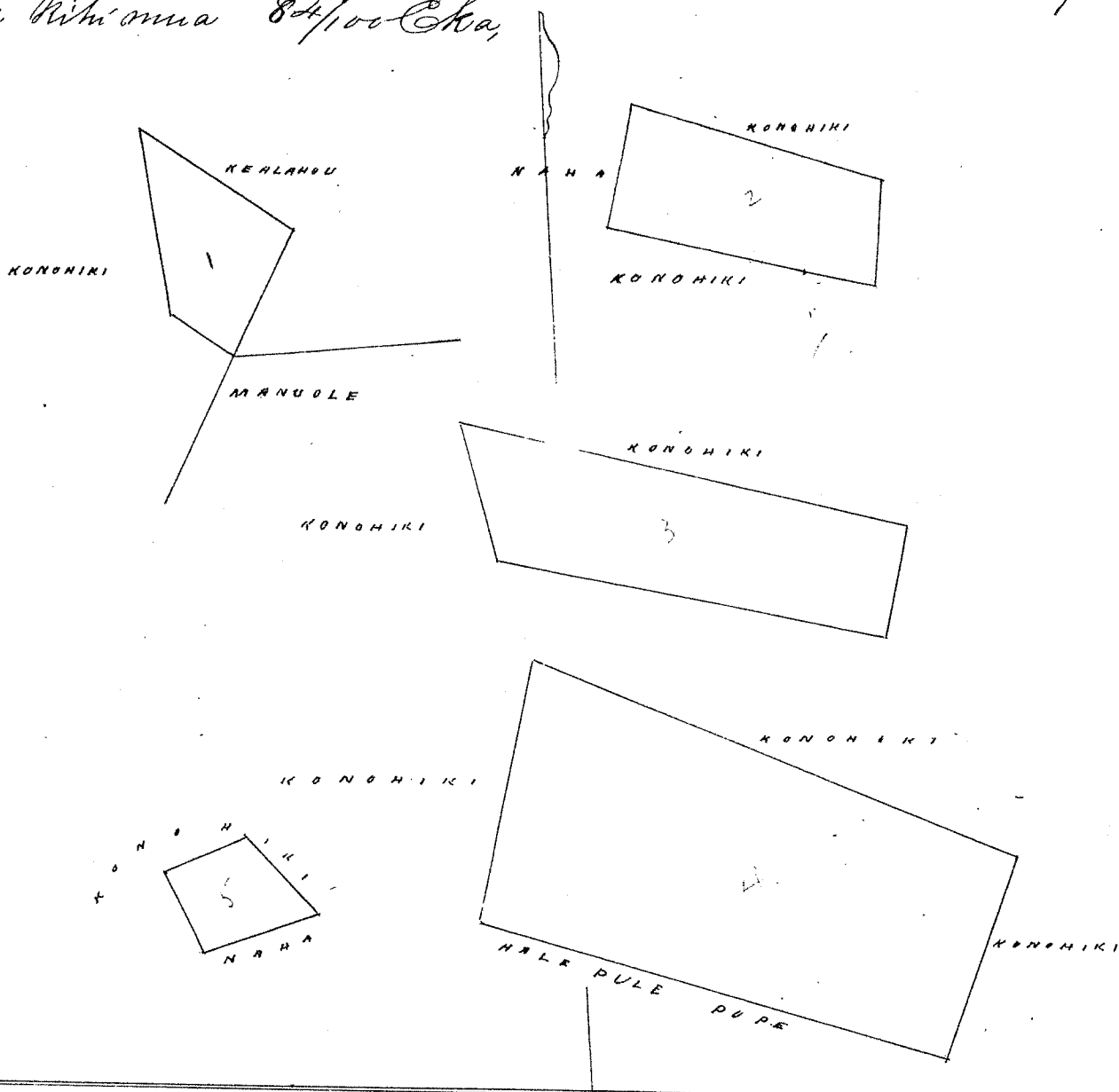

Uku Pau Loa # 10

W. L. Lee
G. M. Robertson
J. H. Kaulahao
J. H. Smith

Honolulu 27 Aug. 1852.

Keleu 8845 Koholo papa

Kaliatiniu Kula Maui

Apana 1 Kula ma Kapuna E hoomaka ana oia ke Pihia Nema a e holo ana, Ak. 85 1/2 No. 17,00 paauku ma Honohiki Ak. 2 3/4 No. 11,30 paauku ma Honohiki Ak. 8 1/2 No. 5,33 paauku ma Honohiki kem. 80 No. 12,50 paauku e pahi ana ia Honohiki, kem. 24 No. 10,30 paauku ma Honohiki, kem. 51 No. 4,30 paauku ma Honohiki i ke Pihia oia, 2 1/2 Eka,

Apana 2 Kula ma Alakaia E hoomaka ana oia ke Pihia Nema, a e holo, Ak. 25 No. 5,50 paauku ma Honohiki Ak. 5 1/2 No. 7,40 paauku ma Honohiki kem. 50 No. 3,80 paauku ma Honohiki Ak. 63 No. 9,00 paauku ma Honohiki kem. 27 No. 6,50 paauku ma Honohiki kem. 63 No. 8,60 paauku ma Kuaihulu kem. 75 No. 9,35 paauku ma Kuaihulu i ke Pihia oia 5 1/2 Eka,

Apana 3 Kula ma Pahoa E hoomaka ma ke Pihia Aka, a e holo, kem. 36 No. 2,55 paauku ma Honohiki kem. 6 1/2 No. 11,10 paauku ma Pihia, Ak. 77 No. 2,38 Honohiki Ak. 21 No. 2,30 paauku ma Honohiki Ak. 64 No. 12,20 paauku ma Honohiki i ke Pihia oia 4 1/2 Eka,

A. F. Turner,
Luna ana oia

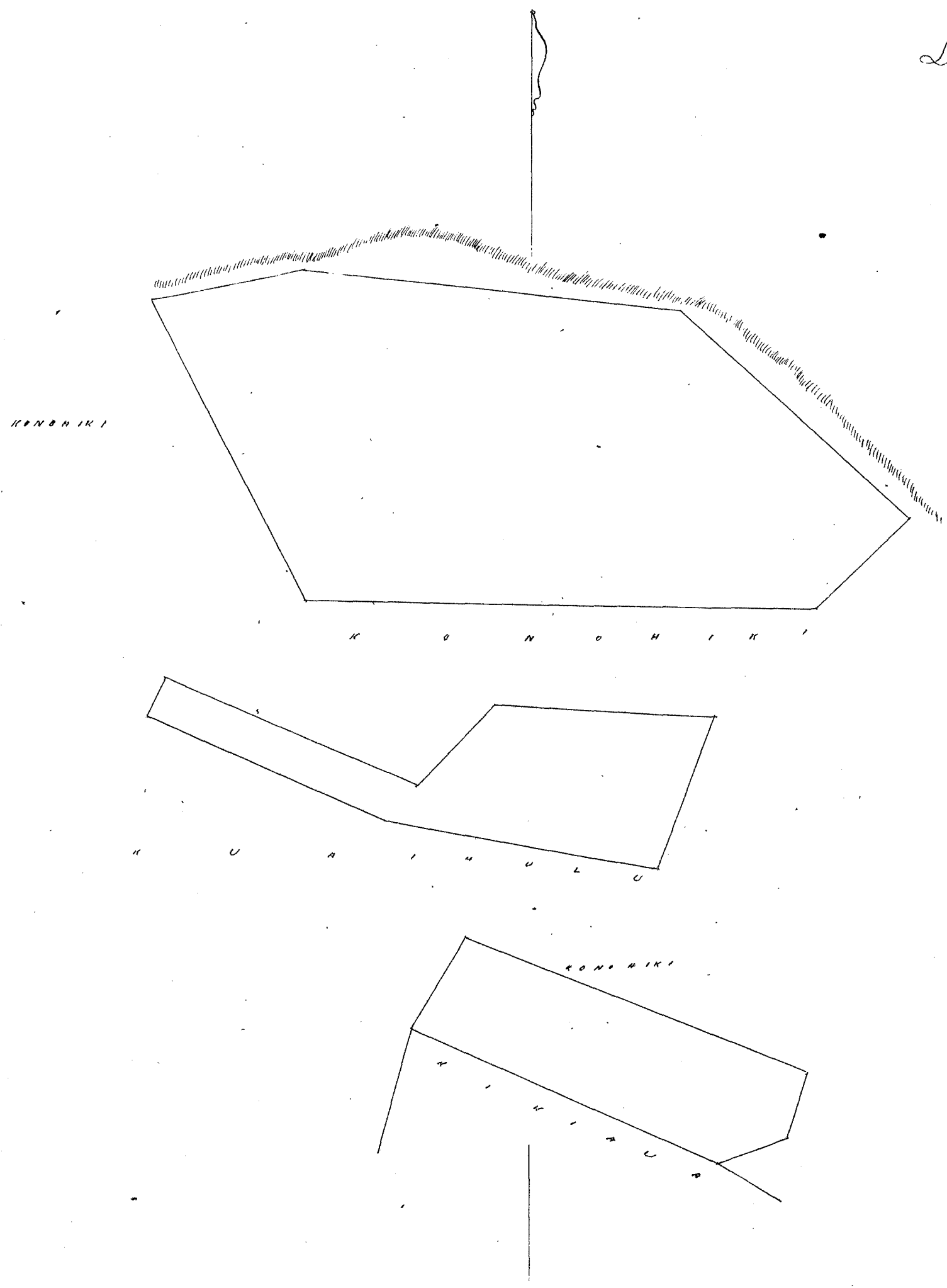

Wm Pau Loa \$15.
W. L. Lee
G. M. Robertson
J. Kukanalaha
J. H. Smith

Honolulu 27 Aug. 1852.

Hoenu 8808 Kōkēliaiku

Waikūhuli Kūka Maui

Kūka ma Laie & Kawilaaha, E hoomāka ana ma ke Kīhi Nōm. Ak. a e holo ana, Nōm. 78° Ki. 8,70 pautu e pili ana i ke Eka, Nōm. 50. Ki. 3,88 pautu e pili ana i ke Opunui; Nōm. 60° Ki. 7,26 pautu e pili ana i ke Opunui; Nōm. 51° Ki. 3,00 pautu e pili ana i ke Māke. Nōm. 52° Ki. 17,38 pautu e pili ana, i ke Māke, Nōm. 25 1/2° Ki. 4,10 pautu ma ke Nāpela, Ak. 45 1/2° Ki. 2,70 pautu e pili ana i ke Puonui Ak. 82° Ki. 2,95 pautu e pili ana i ke Puonui, Ak. 52° Ki. 4,62 pautu e pili ana i ke Puonui, Ak. 61° Ki. 6,70 pautu e pili ana i ke Puonui, Ak. 61° Ki. 5,85 pautu e pili ana i ke Uli; Ak. 80° Ki. 5,90 pautu ma ke Uli Ak. 41° Ki. 7,90 pautu e pili ana i ke Lono, i ke Kīhi ma, 20 Eka,

3 Feby 1852

A. F. Turner
Luna ana aina

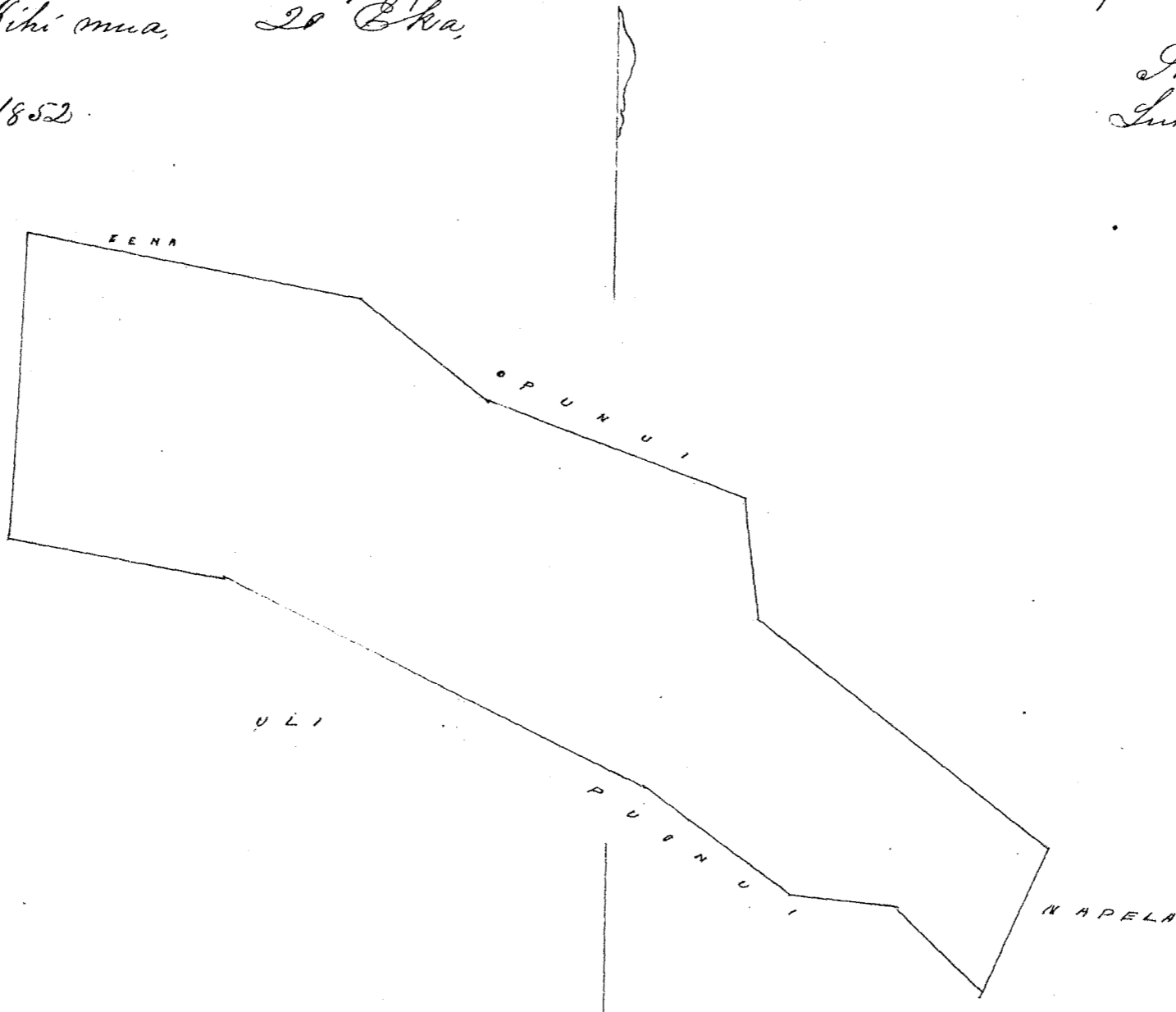

Wm. Pau Loa #10.

W. L. Lee

G. M. Robertson

J. Kikaulaha

J. H. Smith

Honolulu 27 Aug. 1852

Hoenu 5165 Kūpala

Mokae Kāna Maui

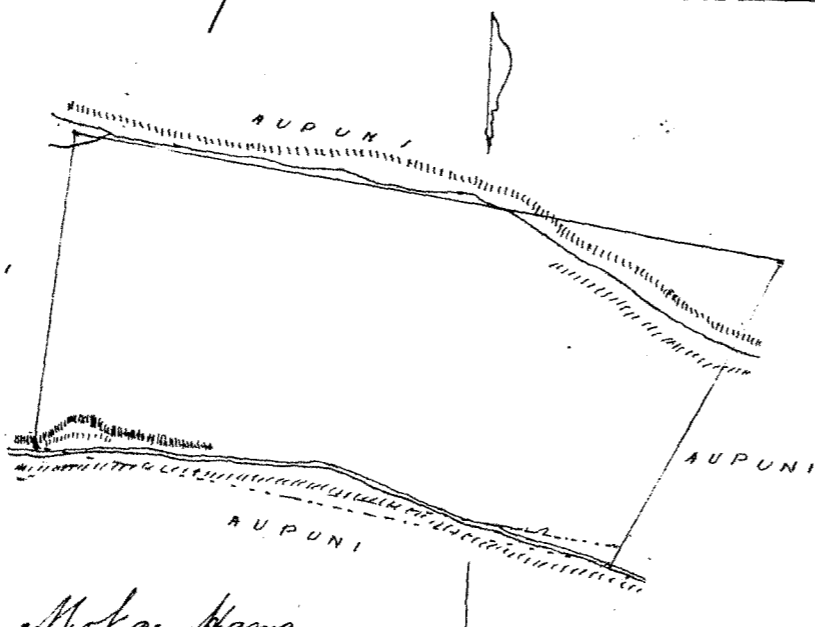

Kūpala Mokae Kāna

Ili o Kamachū. E hoomāka ana ma ke Kīhi Nōm. Nōm. a e holo ana, Ak. 30° Ki. 10,90 pautu e pili ana i ke Kūpuni, Ak. 79° Ki. 22,70 pautu e pili ana i ke Kūpuni, Nōm. 8° Ki. 1,000 pautu e pili ana i ke Kūpuni ma ke Kāhawai, alaila e pili ana i ke Kāhawai, i ke Kīhi ma 20 Eka,

12 April 1852

A. F. Turner
Luna ana aina

Uku Pau Loa # 12.

W. L. Lee
G. M. Robertson
J. Kukanahao
J. H. Smith

Honolulu 27 Aug 1852

Holu 4955 Kapuki

Hanoo Aana Maui

Apana 1. E hoomaka ana ma ke Pihikihina Akau, a e holo ana kem. 67 1/2 Mo. 12,000 pautu e pili ana i ke Konoiki; kem 11 Mo. 3,40 pautu e pili ana i ke Konoiki; Ak. 81 Mo. 15,200 pautu ma ke Pihikihina, ma ke Mahakai alaila e pili ana i ke Mahakai; i ke Pihikihina ma 7 3/4 Eka.

Apana 2. E hoomaka ana ma ke Pihikihina, Akau a e holo ana, Ak. 86 Mo. 10,41 pautu e pili ana i ke Pihikihina, Ak. 12, Mo. 4,15 pautu e pili ana i ke Puhau, kem. 8 2 3/4 Mo. 9,60 pautu e pili ana i ke Konoiki, kem. 4, Mo. 3,70 pautu e pili ana i ke Konoiki; i ke Pihikihina ma 3 88/100 Eka.

20 Aperila, 1852

A. F. Turner,
Luna Ana Aina

7.75
3.88
11.63

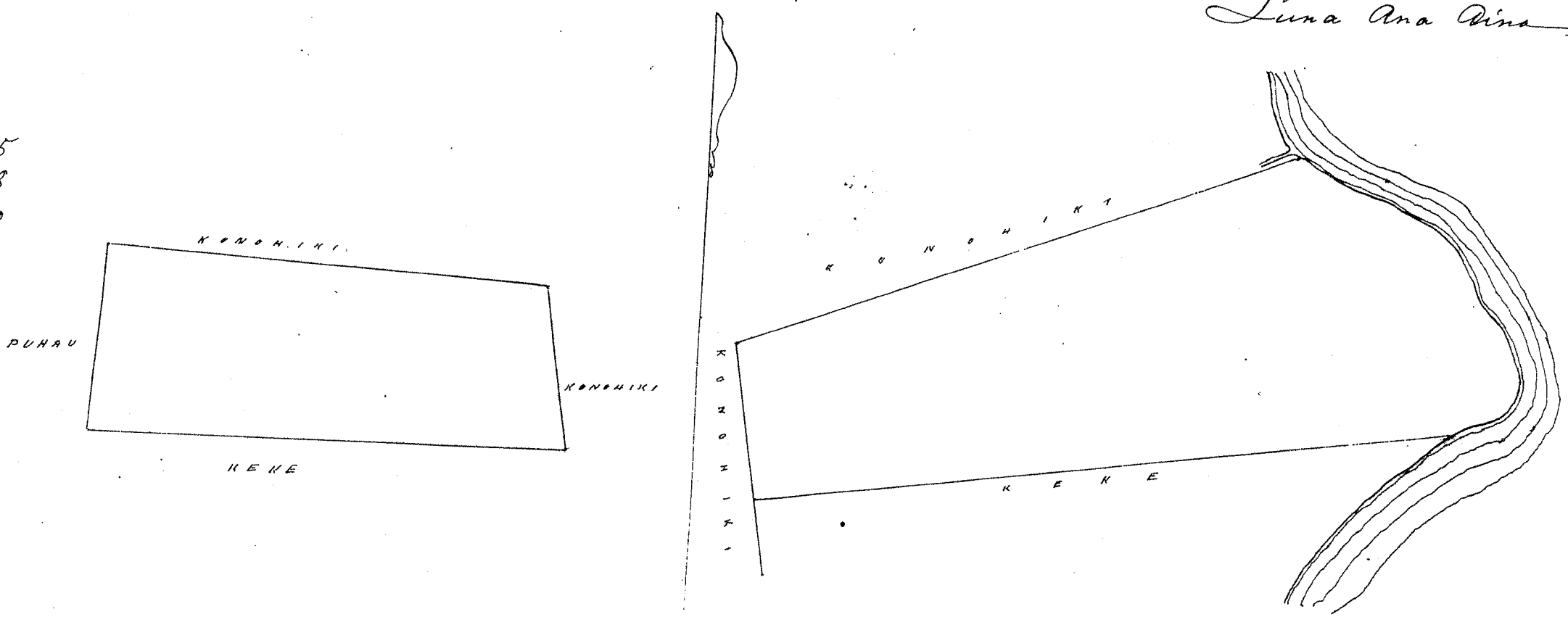

Uku Pau Loa # 10

W. L. Lee
G. M. Robertson
J. Kukanahao
J. H. Smith

Honolulu 27 Aug 1852

Holu 4855 Haniko (no Aoa)

Waiokonu Aana Maui

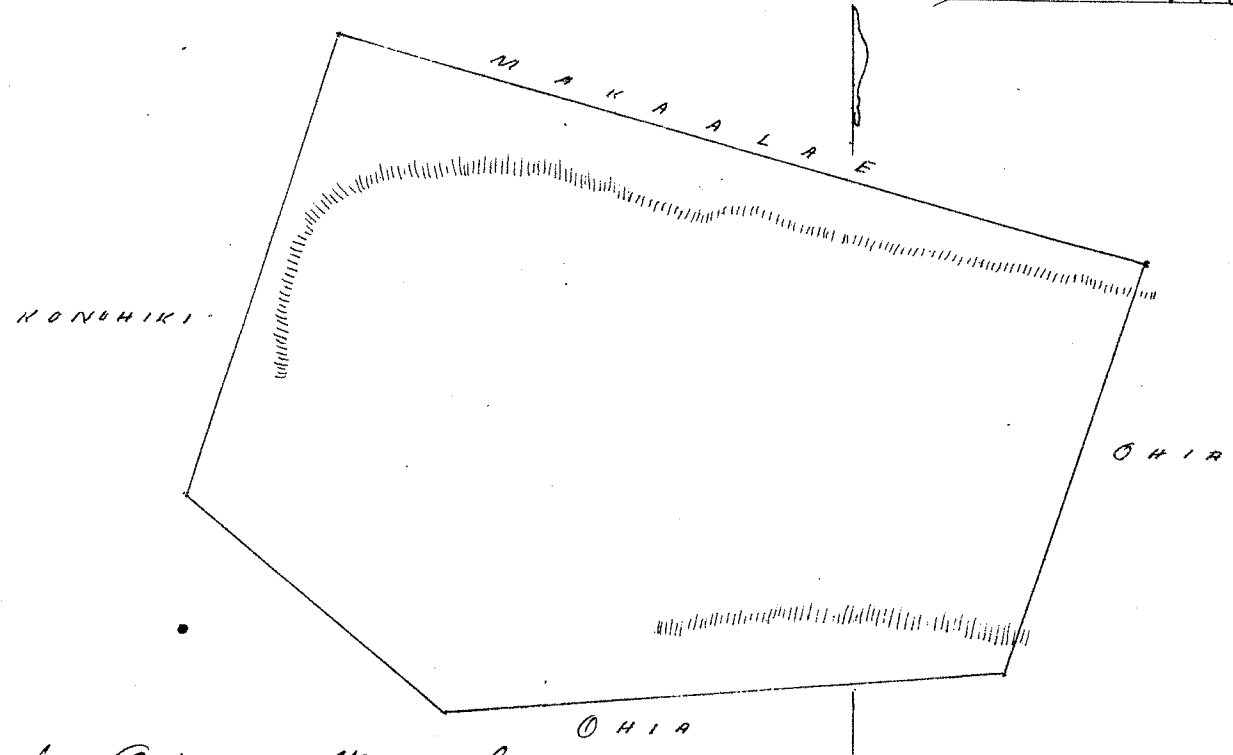

Haniko Opuwai, Waiokonu
E hoomaka ana ke Pihikihina Akau, a e holo ana, Ak. 20 Mo. 4,50 pautu e pili ana i ke Ohia Ak. 74 Mo. 8,80 pautu e pili ana i ke Makaanalae, kem. 19 Mo. 5,70 pautu e pili ana i ke Konoiki kem. 19 Mo. 3,50 pautu e pili ana i ke Konoiki; Ak. 87 Mo. 5,95 pautu ma ke Ohia i ke Pihikihina ma 5 Eka.

A. F. Turner,
Luna ana Aina

Wm Pau Leaf
W. L. Lee
G. M. Robertson
J. Kekaulaha
J. H. Smith

Honolulu 27 Aug 1852

Heleu 8987 Kounaka

Popoia Kipahulu Maui

Kounaka (Ak) Popoia, 1 Kipahulu Maui

Hoormaka ana ma ke kiki Hikina Kema, (onakai) a e holo ana Ak, 66, Ki, 400 pautu e pili ana i ke Kahakai, Dem. 56, Ki 490 pautu e pili ana i ke Kahakai Ak, 70, Ki, 370 pautu e pili ana i ke Kahakai, Ak 11, Ki 1375 Pautu e pili ana me Kapauniki

Ma Keia Manui Kupuni

Ak, 10 3/4 Ki 26, 10 pautu e pili ana i Kapauniki Ak, 13, Ki, 765 pautu e pili ana i Ke Kapauniki Ak, 8 Ki, 14, 30 pautu e pili ana me Kapauniki Ak, 17, Ki 1, 42 pautu e pili ana me Kapauniki Dem, 7, Ki, 8, 60 pautu e pili ana ma ke Popoia 1 ma ke Ka-hawai alaila e pili ana i ke Kahawai, Dem. 9, Ki, 4, 80 pautu ma ke Manui Dem, 12, Ki, 5, 31 pautu e pili ana i Popoia 2, Dem, 2 1/2, Ki 3, 58 pautu e pili ana me ke Popoia 2, Dem, 7, Ki 4, 68 pautu, e pili ana i ke Popoia 2, ma ke pali Kaha-kai, i ke kiki mea. L5, Eka,

18 Malaki 1852

A. F. Turner

Luna ana aina

Hoia i ana aina hon (entered by Wm Pau Leaf, claimant has accepted gift for Patent the new survey)

Hoia i Manawaiapua ma Popoia - E hoormaka ma ke kiki Kema a e holo

Ak. 5 3/4 Ki. 528 paut. ma ke Kupuni

Ak. 6 1/2 Ki. 12, 50 "

Dem. 87 " 5, 40 "

80 3/4 Eka (Charles S. Kittredge ana aina Sep. 14 1854)

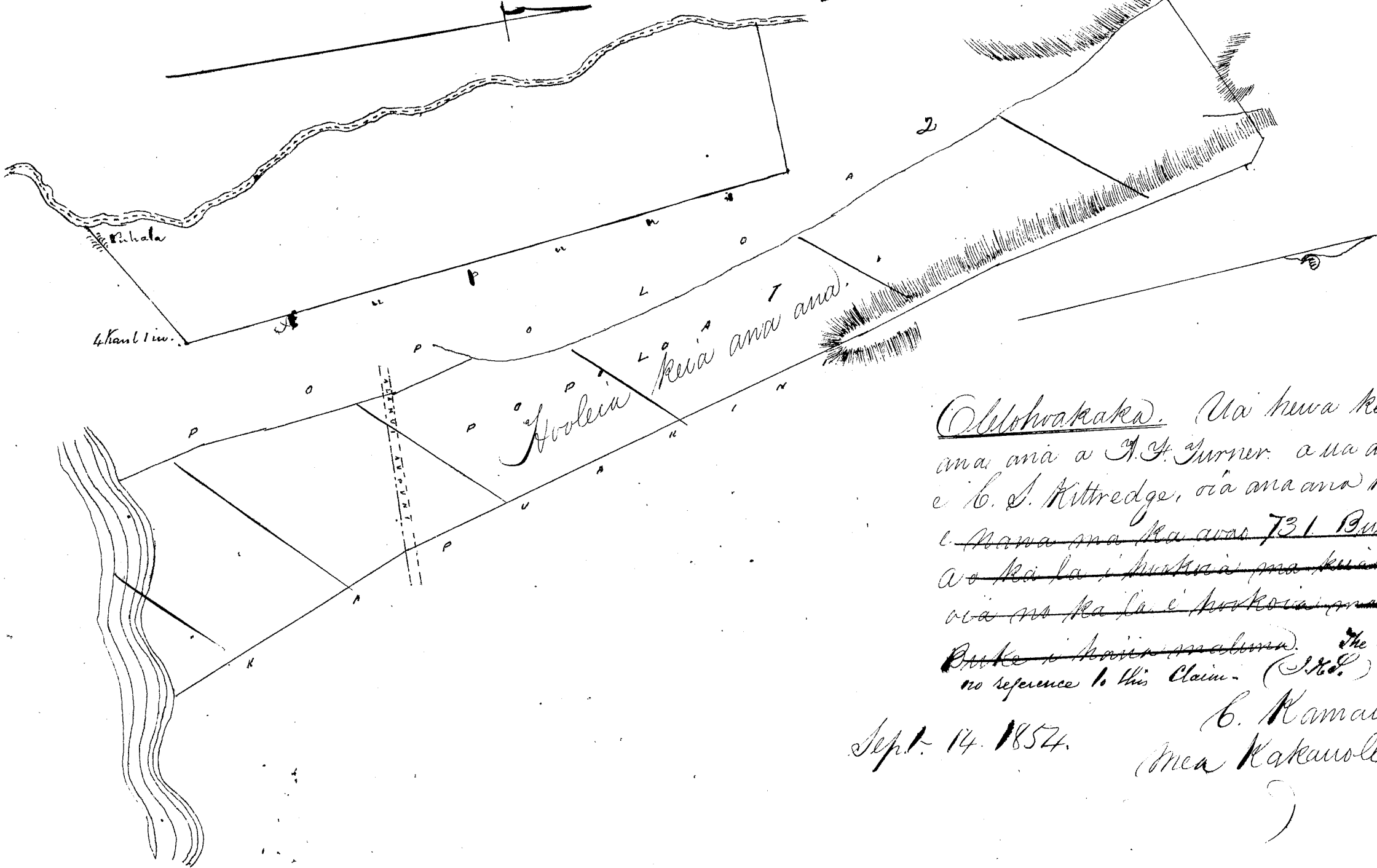

Ololohwakaka. Ua huwa keia ana ana a A. F. Turner. a ua ana honia e C. S. Kittredge, oia ana ana ka pono. e mana ana ka awa 731 Buks y Hoko. a e ka la i hukua i ma kua Buks oia ana ka la i hukua i ma kua Buks i maia maia. The crossed lines have no reference to this claim. (J.H.S.)

Sept. 14 1854.

C. Kamai
mea Kakuolelo

Wm Pau Leaf 20

W. L. Lee

G. M. Robertson

J. Kekaulaha

J. H. Smith

Honolulu 27 Aug 1852

Heleu 4074 Akua

Kaupua & Hana Maui

He aina. Ohia E hoomaka ana ma ke Pihii Kihina Kema, makai a e holo ana, Ak. 12. No. 1220
pauku e pili ana i Kalihii Ak. 14. No. 647 pauku e pili ana i Kalihii Ak. 22. No. 321 pauku e pili
ana i Kalihii Hem. 70. No. 622 pauku e pili ana i Kalihii Hem. 19. No. 1002 pauku e pili ana i Ka-
lihii Hem. 6. No. 2130 pauku e pili ana i Kalihii ma ke Kahakai (pale) alaia e pili ana i ke
Kahakai, i ke Pihii ma, 20/100 Eka.

Apana 2, Loko Kalo ma E hoomaka ana ma ke Pihii Kema, a e holo ana
Ak. 42 1/2. No. 459 pauku e pili ana i ke Moa, Ak. 44. No. 163 pauku e pili ana ma ke ala
mau Aupuni, Hem. 25. No. 442 pauku ma ke alama Aupuni, Ak. 49 1/2. No. 142 pauku ma
ke alama Aupuni, i ke Pihii ma, 6/100 Eka,

Apana 3 Niu ma Kawaiwapa. E hoomaka ana ma ke Pihii Kema, a e holo ana
Ak. 79. No. 380 pauku e pili ana i ke Aupuni, Ak. 7. No. 146 pauku e pili ana i ke Aupu-
ni. Hem. 80. No. 413 pauku e pili ana, i ke Aupuni, Hem. 20. No. 455 pauku e pili ana i ke
Aupuni, i ke Pihii ma 6/100 Eka.

21 April 1852

A. F. Turner

Luna ana aina

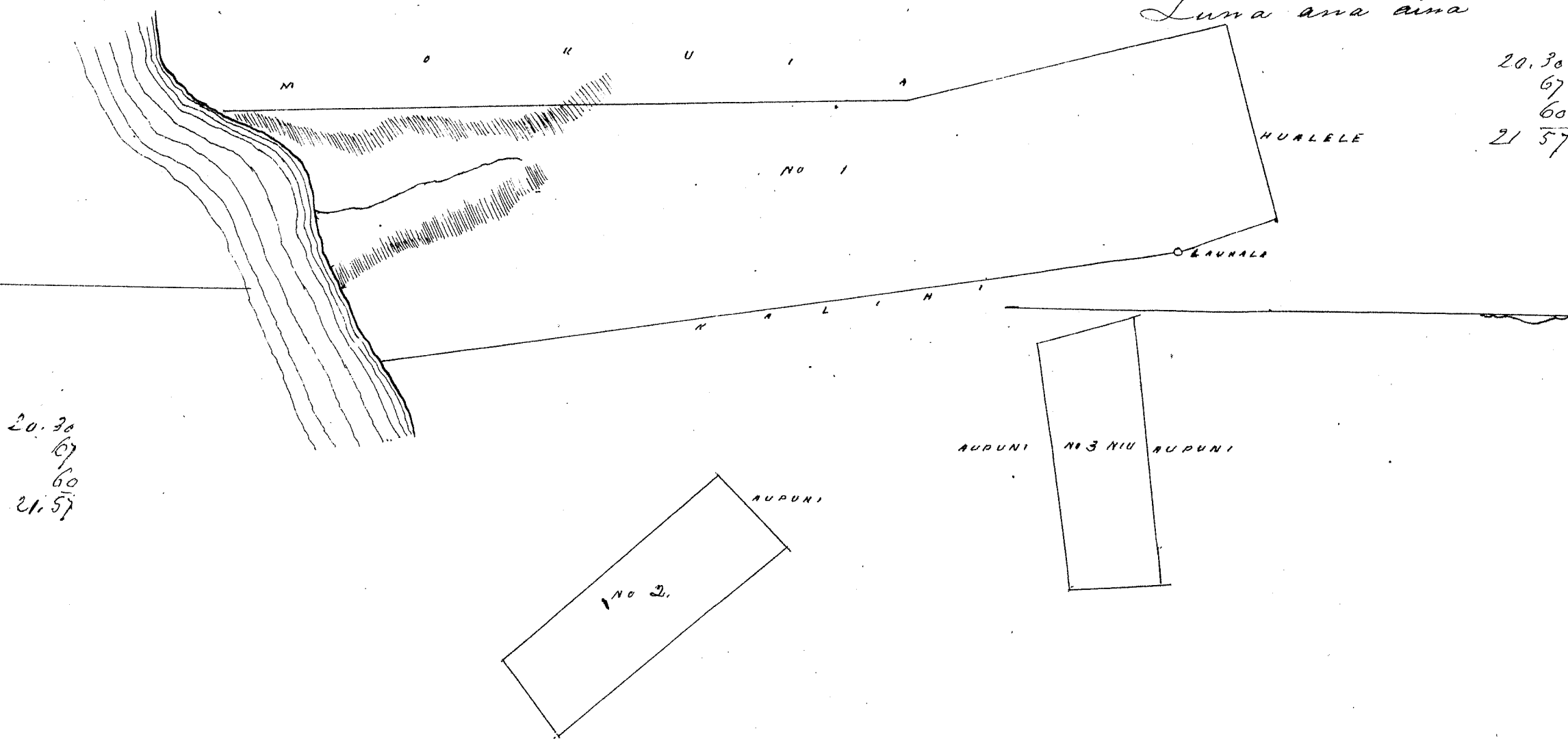

Wm Pau Loa # 12.

W. L. Lee
G. M. Robertson
J. Kekaulaha
J. H. Smith

Honolulu 27 Aug 1852

Heleu 6775 Keekuli

Koali Hana Maui

Apana 1. Kula, ma. E hoomaka ana ma ke Pihii Kom. Akua, a e holo ana
Ak. 45. No. 104 pauku e pili ana i ke Honohiki, No. 67. No. 171 pauku e pili ana i ke Honohiki.
Ak. 66. No. 100 pauku e pili ana i ke Honohiki, Hem. 3. No. 10,60 pauku e pili ana i ke Honohiki
Hem. 56. No. 400 pauku e pili ana i ke Honohiki Hem. 51. No. 690 ma ke Kahakai alaia
e pili ana i ke Kahakai, ma ke Kahawai, alaia e pili ana i ke Kahawai, i ke Pihii
ma 11 3/4 Eka.

Apana 2, Loko Kalo ma E hoomaka ana ma ke Pihii Kema a e holo ana
Ak. 21. No. 440 pauku e pili ana i ke Honohiki Ak. 53. No. 370 pauku ma ke Honohiki
Hem. 40. No. 94 pauku e pili ana i ke Honohiki Hem. 47. No. 419 pauku e pili ana i ke
Honohiki i ke Pihii ma 1/2 Eka.

A. F. Turner
Luna ana aina

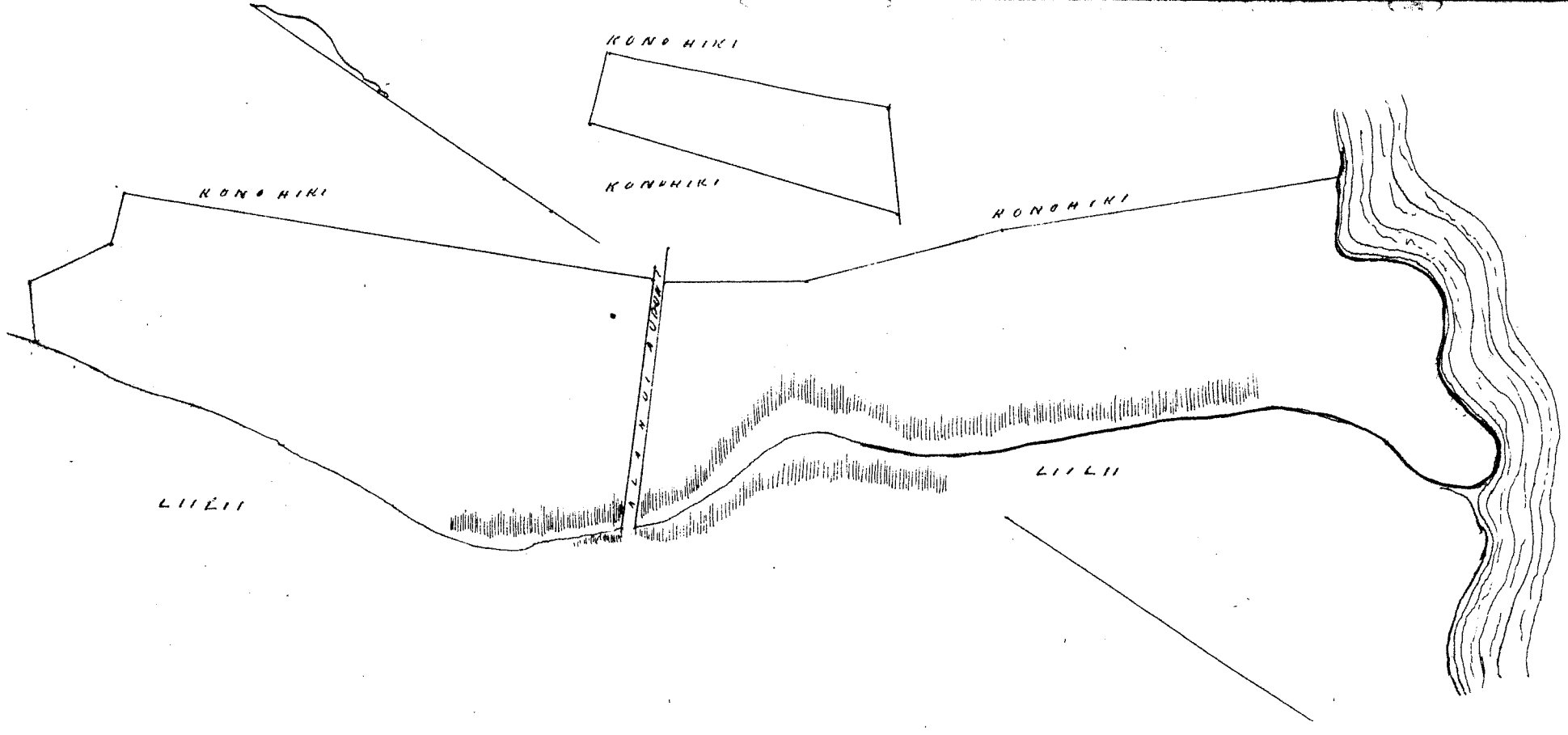

Uku Pau Loa # 10
 W. L. Lee
 G. M. Robertson
 J. Kekaulahao
 J. H. Smith

Honolulu, 27 Aug. 1852

Keolu 5176^c Lii Lii Koale Hana Maui

Lii Lii Ili o Waikakoi Koale Hana Maui

Ke hoomaka ana ke kahi kama (makaai) a e holo ana. Ak. 16. Ke 1. paau e pili ana i ke Konohiki Ak. 23 1/2 Ke. 4.60 paau e pili ana i ke Konohiki Ak. 30 Ke. 290 paau e pili ana i ke Konohiki Ak. 18. Ke. 152 paau e pili ana i ke Konohiki Ak. 50 Ke. 200 paau e pili ana me ke Konohiki ma ke kahi e pili ana i ke Pahawai i ke kahi mua. 5-46/100 Eka,

18 March 1852

A. F. Turner
 Luna ana aina

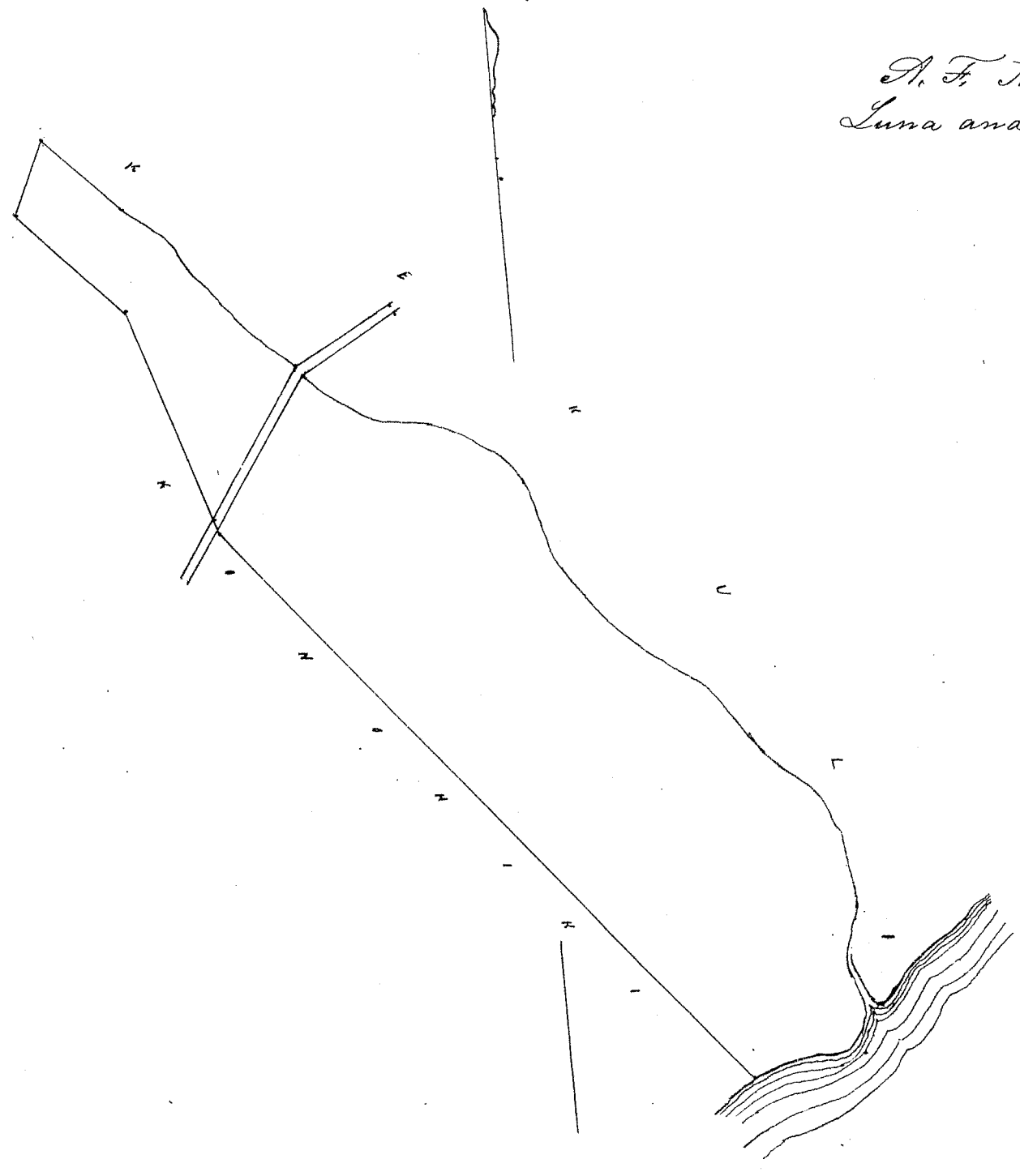

Uku Pau Loa # 7
 W. L. Lee
 G. M. Robertson
 J. Kekaulahao
 J. H. Smith

Honolulu, 27 Aug. 1852

Okuu ma Palula Moulea Kana, E hoomaka ana ma ke kahi Kikina Kema, a e holo ana, Ak. 5 1/2 Ho. 649 pautu e pili ana i ke Honohiki Ak. 45 1/2 Ho. 930 pautu e pili ana i ke Honohiki Hem. 67 Ho. 323 pautu e pili ana ma ke Alanui Aupuni, Ho. 37 Ho. 560 pautu ma ke Kalahi Ho. 48, Ho. 1120 pautu e pili ana i ke Kalahi ma ke Hakakai, alaila e pili ana i ke Hakakai, i ke kahi mua 5 8/100 Eka,

Apana 2. 2 Loi ma Kahoa, (Ho) E hoomaka ana ma ke kahi Kema a e holo ana, Ak. 60 Ho. 1118 pautu e pili ana ia Manu, Ak. 37 Ho. 131 pautu e pili ana ia Kupu, Hem. 69 Ho. 95 pautu e pili ana ia Manu, Hem. 29 Ho. 145 pautu e pili ana ia Manu, i ke kahi mua, 9/100 Eka,

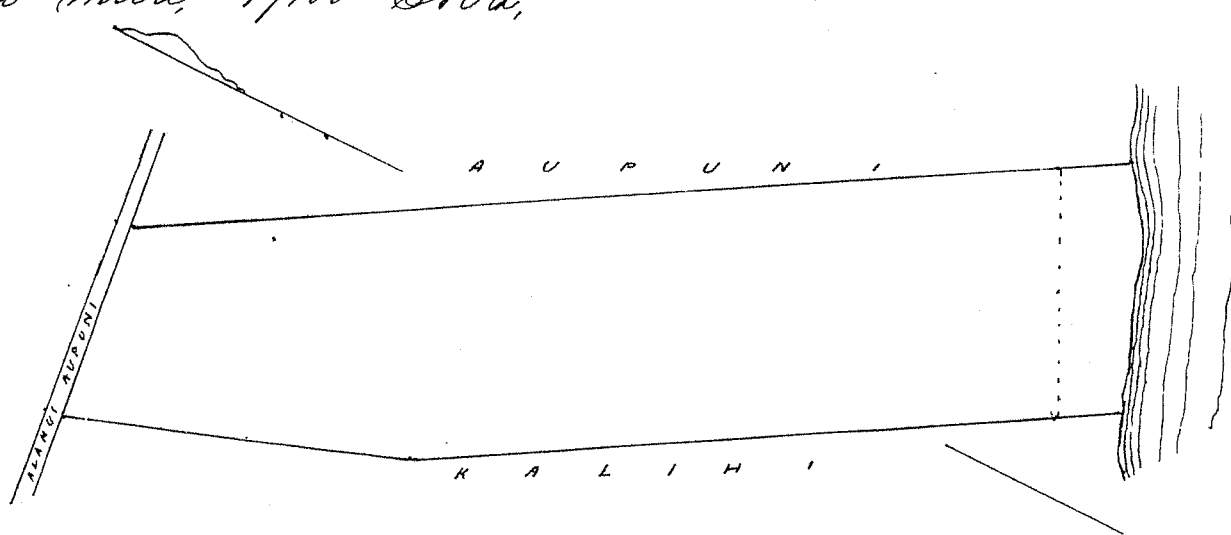

A. F. Turner.
Luna ana aina

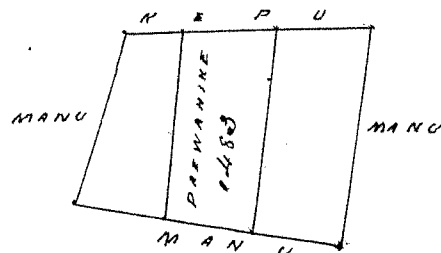

Uku Pau Loa # 6

M. L. Lee
G. M. Robertson
J. Hekaulahas
J. H. Smith

Honolulu 27 Aug 1852

Heleu 5218 Ihu

Kikoo Kipahulu Maui

Ili. Honolulu, E hoomaka ma ke kahi Kikina Kema, ma Kai a e holo ana Ak. 7 1/2 Ho. 266 pautu e pili ana ia Halualani, Ak. 11 Ho. 200 pautu e pili ana i ke Halualani, Ak. 16 1/2 Ho. 400 pautu e pili ana ia Halualani, Ak. 12 Ho. 500 pautu e pili ana ia Halualani, Hem. 85 Ho. 806 pautu e pili ana i ke Alanui Aupuni, ma ke Kahawai alaila e pili ana i ke Kahawai, ma ke Kai, alaila e pili ana i ke Hakakai i ke kahi mua, 7 1/2 Eka,

20 April 1852,

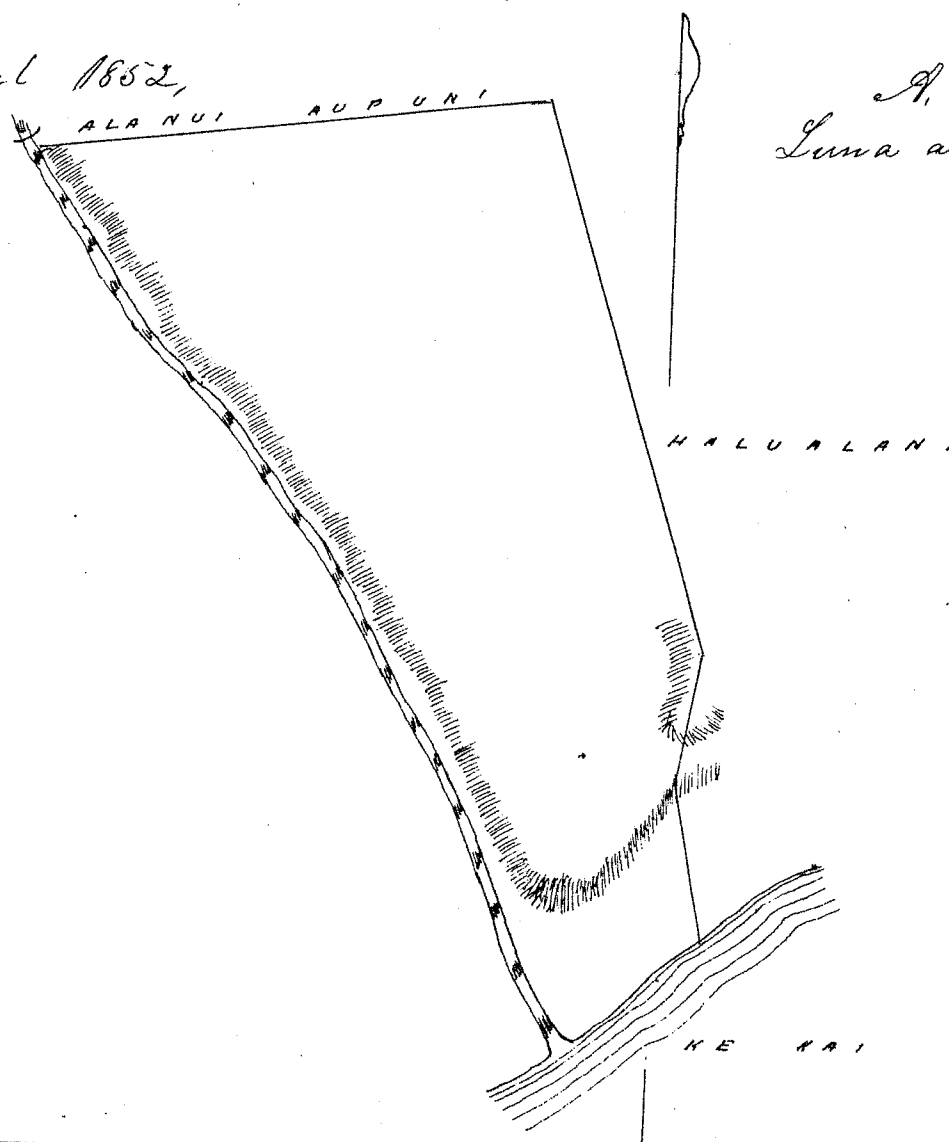

A. F. Turner,
Luna ana aina

Uku Pau Loa # 8

M. L. Lee
G. M. Robertson
J. Hekaulahas
J. H. Smith

Honolulu, 27 Aug, 1852,

Heleu 4670 Iuau

Heanoo Hana Maui

4670 Iuau, Ili o Kahuakuhiana Heanoo Hana Maui.

Aprana 1. E hoomaka ana ma ke kahi Kihina Heano, a e holo ana, Heu. 79°
No. 4.20 paunku e pili ana i ke Koaalakahi; Ak. 22° No. 4.15 paunku e pili ana me Koaalakahi
Heu. 87 1/2° No. 7.85 paunku e pili ana me Koaalakahi; Ak. 11. No. 2.00 paunku e pili ana i ke Konoohiki
Ak. 87 1/2° No. 11.20 paunku e pili ana i ke Heke, alaila e pili ana i ke Kahakahi; i ke kahi mua
2 3/10 Eka,

Aprana 2. E hoomaka ana ma ke kahi Heano, a e holo ana, Heu. 53. No. 4.90
paunku e pili ana i ke Konoohiki Heu. 15 1/2° No. 7.25 paunku e pili ana i ke Kupe Ak. 65°
No. 9.80 paunku e pili ana i ke Konoohiki Ak. 50. No. 9.00 paunku e pili ana i ke Konoohiki
i ke kahi mua, 5 1/10 Eka,

20 April. 1852.

A. F. Turner.
Luna ana aina

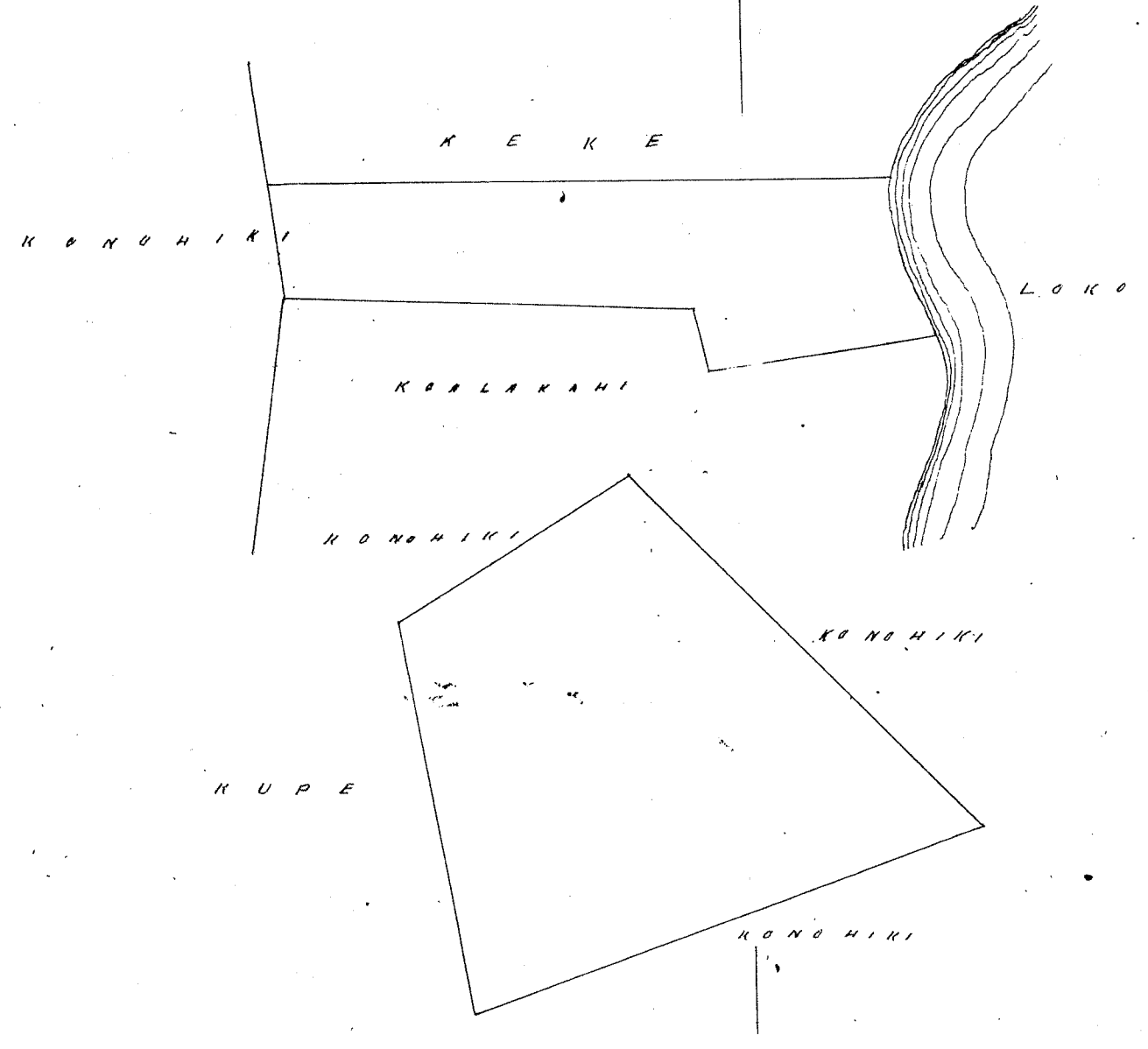

Uku Pau Ioa # 8
W. L. Lee.
G. M. Robertson
J. Kekaulahao
J. H. Smith

Honolulu, 27. Aug. 1852.

Heleu 4853 Kahaku

Heaa Koolau Maui

Kahaku, Ili o Ahiakala Heaa Koolau, Maui.
E hoomaka ana ma ke kahi Konoohana Heano, a e holo ana, Heu. 60. No. 3.00
paunku. e pili ana i ke Heano Heano, Heu. 21° No. 7.40 paunku e pili ana i ke Moi
Ak. 60° No. 4.72 paunku e pili ana i ke Moi, ma ke Kahawai, alaila e pili ana i ke
Kahawai; i ke kahi mua, 1 1/10 Eka,

A. F. Turner
Luna ana aina

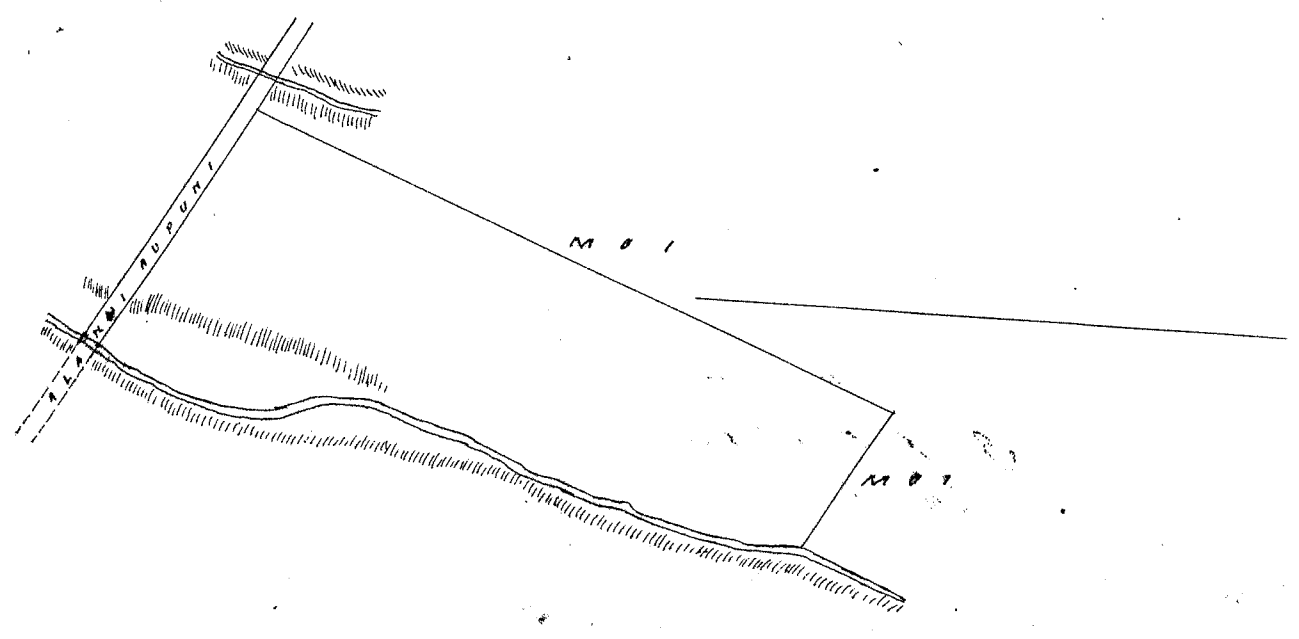

Uku Pau Loa # 4.

W. L. Lee
G. M. Robertson
J. Kakaulaha
J. H. Smith

Honolulu 27 Aug 1852.

Kolu 4876^d Kaili

Makaalae Hana Maui

Kaili ma Kolu Makaalae Hana Maui.
E hoomaka ana ma ke kahi Kama, a e holo ana, Ak. 6 1/2^d Ni. 6.60 pautu e pili ana i ke
Kahakai; Ak. 78^d Ni. 1280 pautu e pili ana i ke Aupuni; e Ak. 82^d Ni. 1115 pautu e pili ana
i ke Aupuni; Ak. 3. Ni. 640 pautu e pili ana i ke Aupuni; Ak. 79 1/2^d Ni. 2490 pautu
e pili ana i ke Kaha, i ke kahi ana, 16 Eka
20 Aperila 1852.

A. F. Turner
Luna ana aina

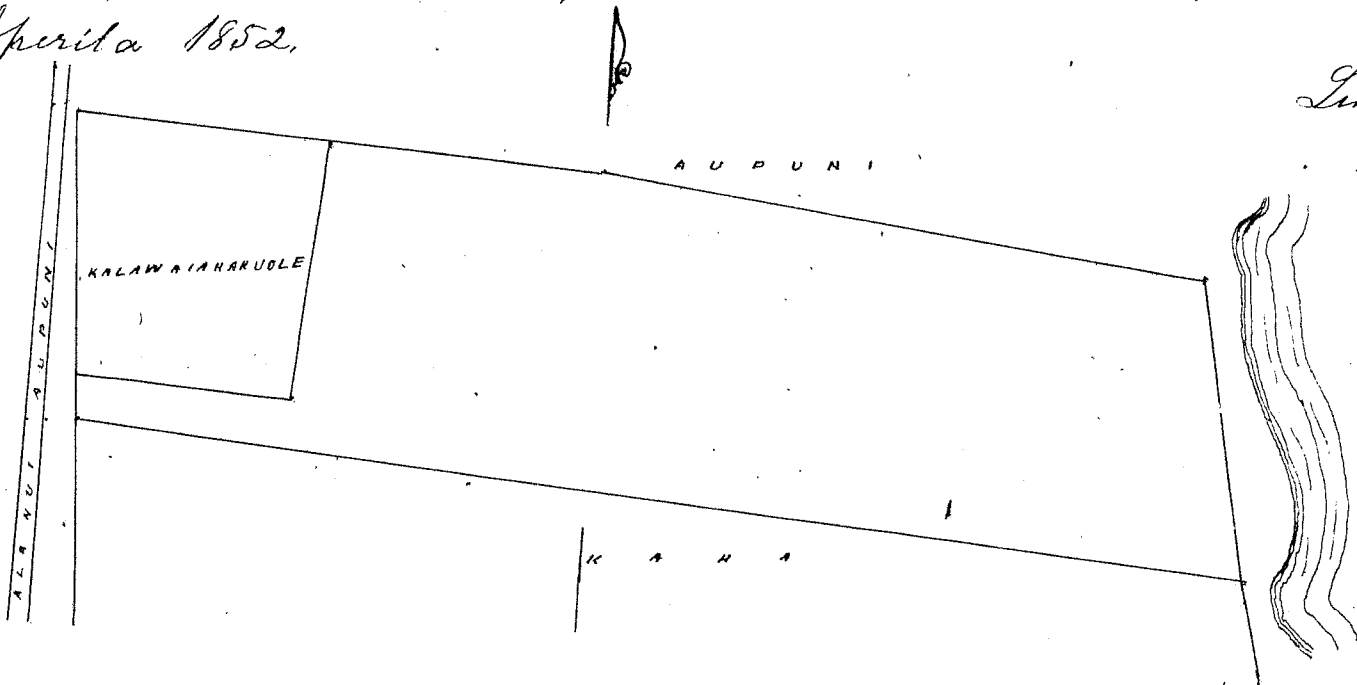

Uku Pau Loa # 12

W. L. Lee
G. M. Robertson
J. Kakaulaha
J. H. Smith

Honolulu 1 Sep 1852.

Kolu 3038 Koolakahi

Kanani Hana Maui

Ki. Kanakaha, E hoomaka ana ma ke kahi Komaana, Kama, a e holo ana
Ak. 85^d Ni. 1170 pautu e pili ana i ke Kupaupuu. Ak. 8 1/2^d Ni. 370 pautu e pili ana i ke Loko
Ak. 79^d Ni. 420 pautu e pili ana i ke Puhau, Ak. 22, Ni. 115 pautu e pili ana i ke Puhau
Ak. 89 1/2^d Ni. 735 pautu e pili ana i ke Puhau, Ak. 4. Ni. 485 pautu e pili ana i ke Kono-
hiki i ke kahi ana, 5 Eka.

A. F. Turner,
Luna ana aina

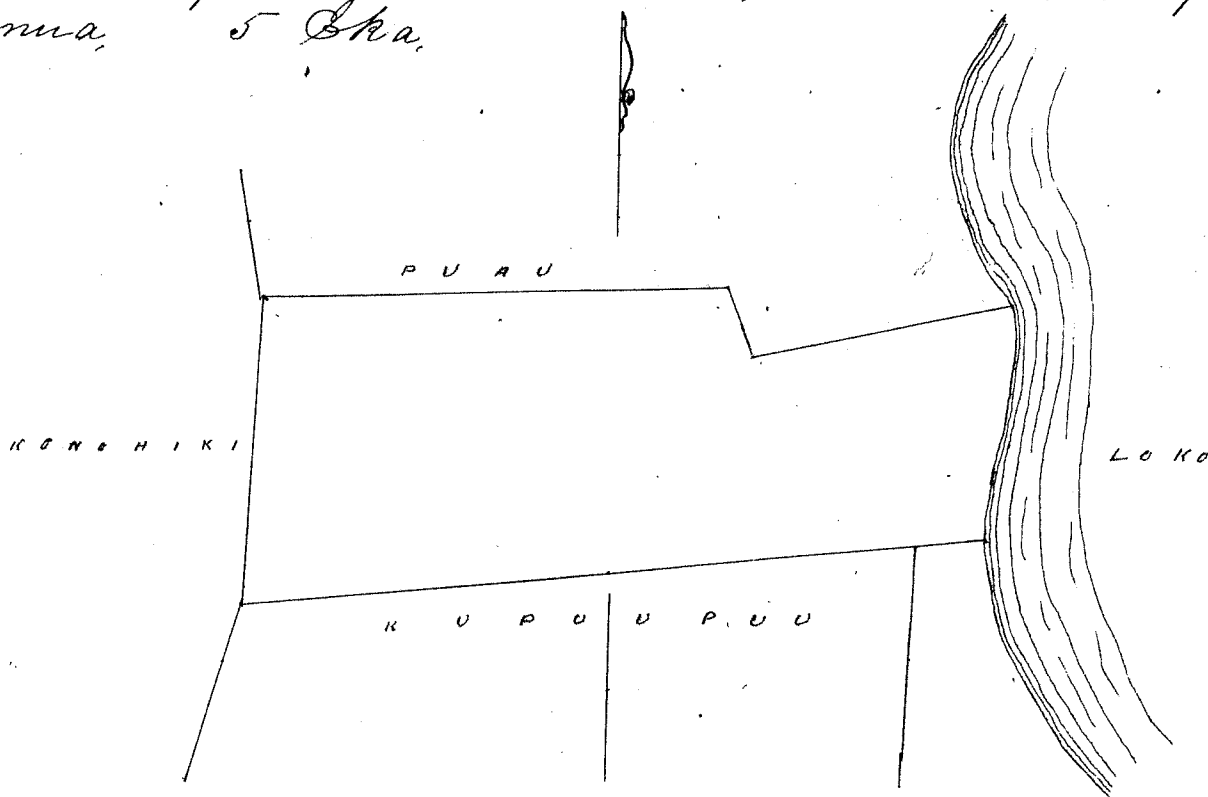

Uku Pau Loa # 7

W. L. Lee
G. M. Robertson
J. Kakaulaha
J. H. Smith

Honolulu 1 Sep 1852

Heleu 5176^o Kales

Koali Hana Maui

Ili o Haleolono E hoomaka ana ma ke Pihii Hema (Makai) a e holo ana
AK, 37, No. 550 pautu e pili ana i ke Honohiki AK, 45, No. 410 pautu e pili ana i ke
Honohiki AK, 47, No. 478 pautu e pili ana i ke Honohiki, AK, 38, No. 356 pautu
e pili ana i ke Alamui Hem. 44, No. 1560 pautu e pili ana ma ke Honohiki ma ke
Pihii mua e pili ana i ke Kahiakai, 5 16/100 Eka,

16 Maraki 1852,

A. F. Turner
Luna ana aina

Apana 2, Ili Kalo, E hoomaka ana ma ke Pihii Hema, a e holo ana
AK, 56, No. 1264 pautu e pili ana i ke Honohiki AK 35, No. 400 pautu e pili
ana i ke Honohiki Hem. 49, No. 1260 pautu e pili ana i ke Honohiki Hem. 34,
No. 250 pautu e pili ana i ke Honohiki i ke Pihii mua 4 7/10 Eka

A. F. Turner
Luna ana aina

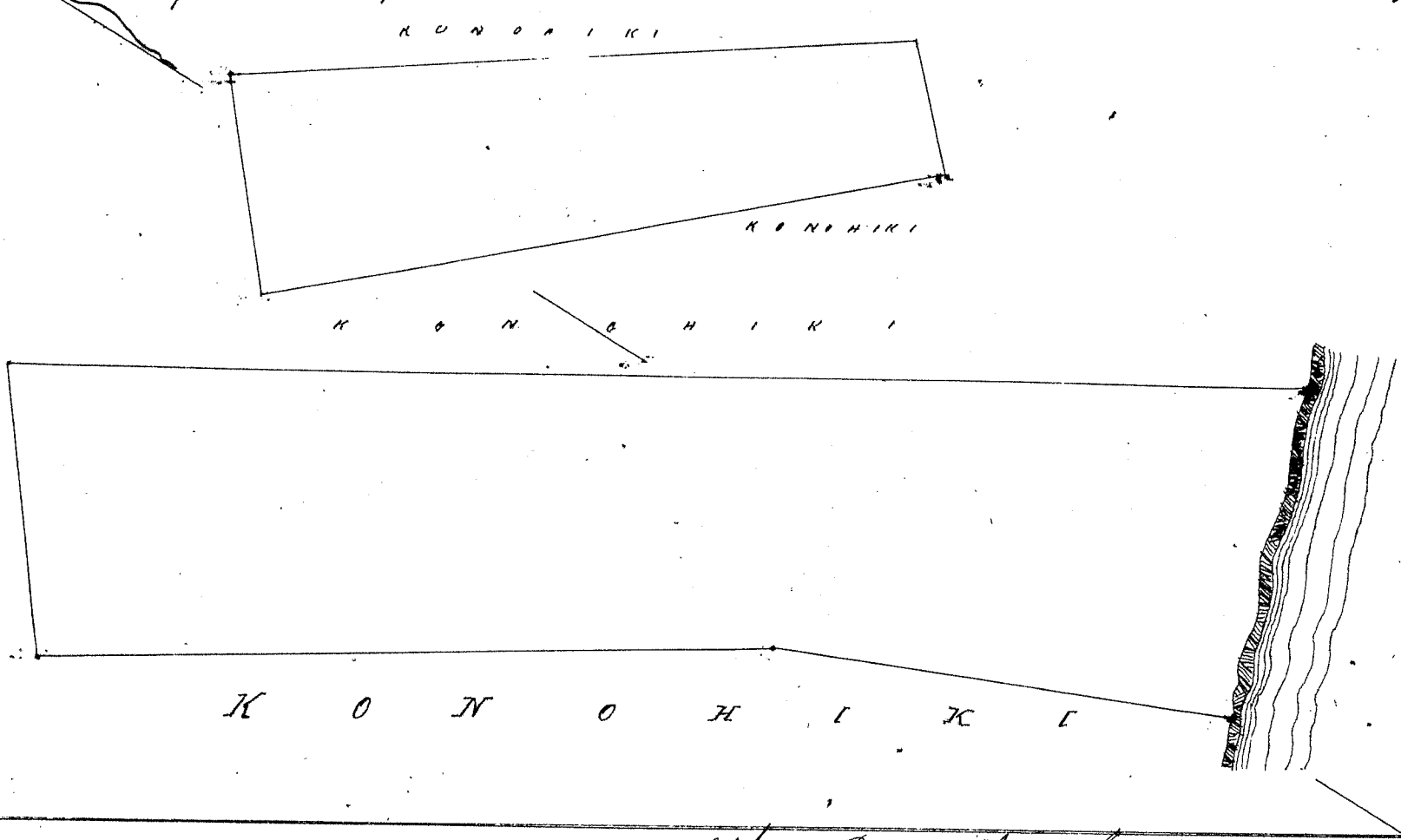

Whee Pau Loa
W. L. Lee
G. M. Robertson
J. M. Kawahara
J. H. Smith

Honolulu 1 Sep 1852

Heleu 3036 Kupuupuu

Haneoa Hana Maui

Apana 1 Ili o Kahuwani E hoomaka ana ma ke Pihii Honohana Hema a e holo
ana AK, 8, No. 390 pautu e pili ana i ke ke Honohiki AK, 68, No. 500 pautu e pili
ana i ke Pihikalani, Hem. 73, No. 720 pautu e pili ana i ke Pihikalani Hem. 1, No. 406
pautu e pili ana, i ke Honohiki AK, 89, No. 1290 pautu e pili ana i ke Honohiki i
ke Pihii mua, 6 3/10 Eka,

Apana 2, Ili o Mania E hoomaka ana ma ke Pihii Honohana Hema
a e holo ana AK, 17 1/2, No. 380 pautu e pili ana i ke Honohiki AK, 85, No. 1670 pautu
e pili ana i ke Koaalakaui, Hem. 3, No. 538 pautu e pili ana i ke Honohiki AK, 86,
No. 1150 pautu e pili ana i ke Humule, i ke Pihii mua 4 9/100 Eka

12 April 1852,

A. F. Turner,
Luna ana aina

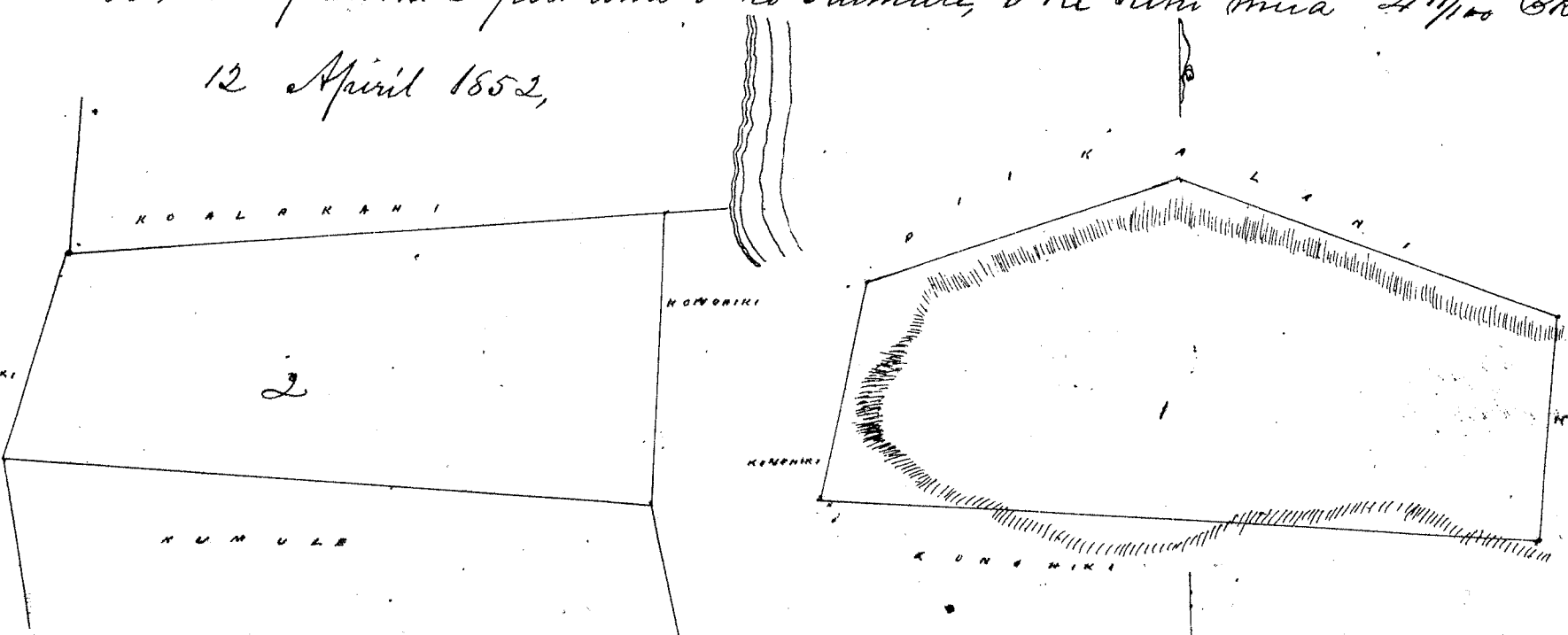

6 30
4 91
17 21

Wm Pau Loa \$10.

W. L. Lee

G. M. Robertson

J. Kaulahao

D. H. Smith

Honolulu 1 Sep 1852

Heleu 9024 Kikiana

Kaliainui Kula Maui

Apana 1. Kula ma Pahoa. E hoomaka ana ma ke Pihī Akau, a e holo hem. 5' Ho. 132 pautu ma Honohiki Hem. 7 1/2. Ki. 1185 pautu ma Honohiki Ak. 25 Ki. 180 pautu ma Honohiki Ak. 54. Ho. 2,19 pautu i ke Honohiki Ak. 6 1/2 Ho. 11,10 pautu ma Maholopapa i ke Pihī mua, 4. Eka,

Apana 2. Kula ma "Hamakahi" E hoomaka ana ma ke Pihī Kema, a e holo Ak. 12 1/2 Ho. 800 pautu ma Honohiki Ak. 10° Ki. 5,90 pautu ma Honohiki Ak. 61° Ki. 660 pautu ma Honohiki Hem. 65. Ki. 655 pautu ma Honohiki Hem 9. Ho. 5,59 pautu ma Honohiki Hem. 45° Ki. 980 pautu ma Honohiki i ke Pihī mua 12 Eka,

Apana 3. Kula ma Awatama E hoomaka ana ma ke Pihī Kema, a e holo Ak. 62 Ho. 1210 pautu ma ke Alanui, Ak. 43. Ki. 4,94 pautu ma ke Honohiki Hem. 70° Ki. 11,00 pautu ma ke Honohiki Ki. 28 Ho. 640 pautu ma Honohiki i ke Pihī mua 6 1/4 Eka,

Apana 4. Kula ma Kalenka. E hoomaka ana ma ke Pihī Kema a e holo Ak. 42. Ki. 710 pautu ma Honohiki Ak. 60. Ho. 890 pautu ma Honohiki Hem. 23° Ho. 6,85 pautu ma Honohiki Hem. 58. Ki. 654 pautu ma Honohiki i ke Pihī mua 5. 35/100 Eka,

Apana 5. Kula ma Waieli "Aupueo" E hoomaka ana ma ke Pihī Kema a e holo. Ak. 68° Ho. 14,30 pautu ma Kahawai o Waieli Ak. 9. Ho. 9,50 pautu ma Honohiki Hem. 65° Ki. 17,00 pautu ma Honohiki Hem. 5 Ho. 7,50 pautu ma Honohiki i ke Pihī mua, 11 3/4 Eka,

6 Jan 1852.

A. F. Turner.
Lima ana aina

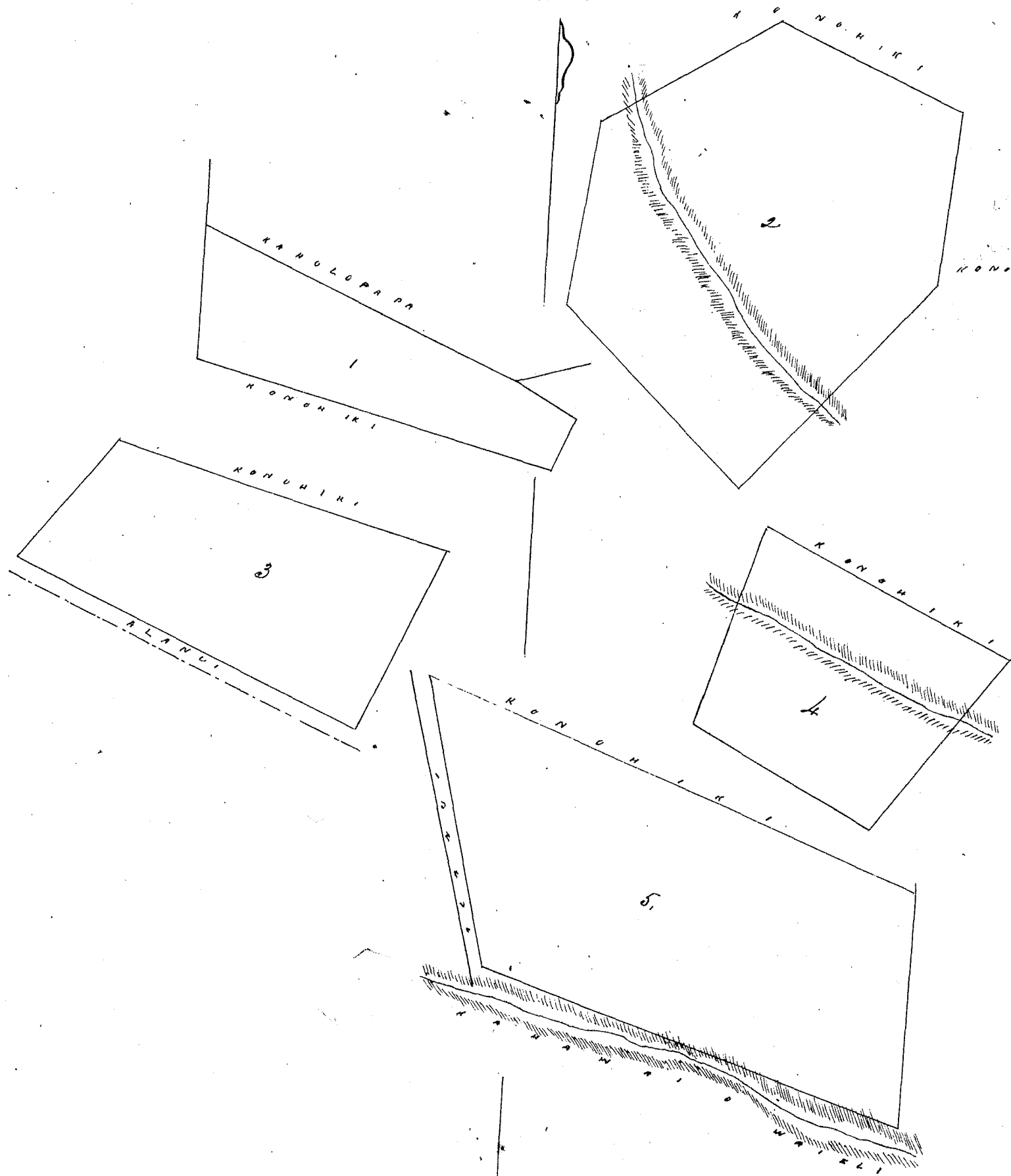

Handwritten notes and signatures, including 'Kaliainui' and 'Aupueo'.

Uku Pau Loa # 19.
W. L. Lee
G. M. Robertson
J. Hekaulahao
J. H. Smith

Honolulu 1 Sep 1852

Heleu 4506 Hoiku Kipahulu Maui

Heleu o Kawahio Kakanoni Ili, Puua, Maulili Kipahulu Maui
E hoomaka ana ona ke kahi hikiina kama, a e holo ana, 56^o No. 10,20 pautu e pili ana i
ke Konoehiki, 81^o No. 3,04 pautu e pili ana i ke Kapuakua, 33^o No. 2,110 pautu e
pili ana i ke Papanui, e 61^o No. 4,96 pautu e pili ana i ke Konoehiki, 52^o No. 6,34
pautu e pili ana i ke Konoehiki ma ke Kahawai, alaila e pili ana i ke Kahawai
i ke kahi mua, 28^o Eka.

18. Maraki 1852

A. F. Turner.
Luna ana aina

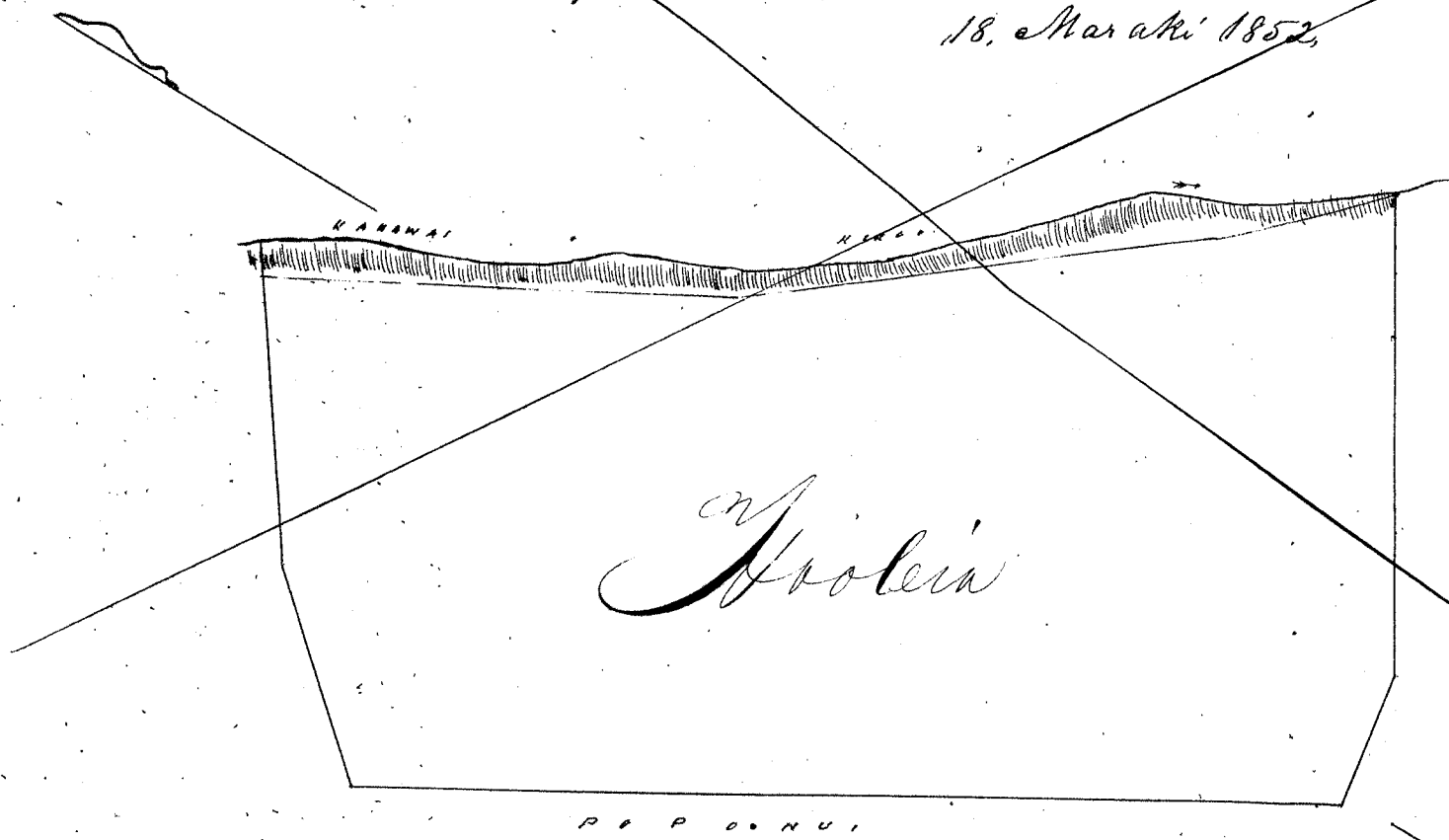

Olohokaka. Ua hewa
keia ona ona a A. F. Turner.
a ua ana mauia e C. S. Kittredge
oia kapono, ma ka avas 730.0
ka Burke y. Hooko. A o kaha
i hokoa ma keia Burke oia.
ma ka la i hokoa ma
kela Burke i hania malama.

Sept 14. 1852. C. Kamoi
Makakaula

Uku Pau Loa # 5
W. L. Lee
G. M. Robertson

Honolulu 1 Sep 1852

Heleu 4939 Kaha Makaalae Kana Maui

Kaha ona Keawaihi Makaalae, Kana
E hoomaka ana ona ke kahi hikiina kama a e holo ana, 6^o No. 370 pautu
e pili ana i ke Kahakai, 80^o No. 24,90 pautu e pili ana i ke Kaili, 8^o No
4,30 pautu e pili ana i ke Aupuni, 81^o No. 25,40 pautu e pili ana i ke Aupuni,
i ke kahi mua 7 Eka,

20 April 1852

A. F. Turner,
Luna ana aina,

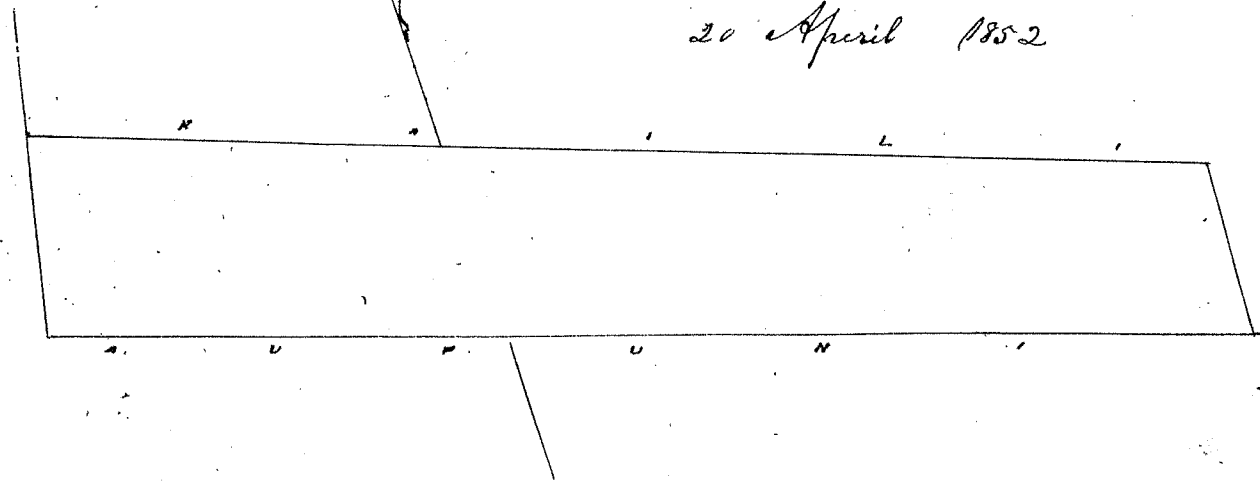

Uku Pau Loa # 8.
W. L. Lee
G. M. Robertson
J. Hekaulahao
J. H. Smith

Honolulu 1. Sep 1852

Heleu 4739 Moiki

Niumalu Hana Maui

Miki Niumalu 1 & 5 Hana Maui

Apana 1 & 3, E hoomaka ana ma ke Pihia Hana, a e holo ana, AK 48° No. 393
pauku e pili ana i ke Alanui, AK 45 1/2° No. 1826 pauku e pili ana i ke Alanui, AK 60°
No. 1011 pauku e pili ana ma ke Kahinawe Hem. 50° No. 668 pauku e pili ana i ke Aupuni,
Hem. 35° No. 550 pauku e pili ana i ke Aupuni, ma ke Alanui Kahiko alaila
e pili ana i ke Alanui Kahiko ma ke Kahawai, alaila e pili ana i ke Kahawai
i ke Pihia mua, 119 1/10 Eka,

Apana 2, ma Niumalu 5.

E hoomaka ana ma ke Pihia Hana, a e holo ana, Hem. 56° No. 630 pauku e pili
ana, i ke Aupuni, Hem 35, No. 582 pauku e pili ana i ke Aupuni, AK 53 1/2°
No. 723 pauku e pili ana i ke Aupuni, AK 47 1/2° No. 560 pauku e pili ana i ke
i ke Alanui Aupuni. 3 3/4 Eka

A. F. Turner,
Luna Ana Aina

11.90
3.75
15.65

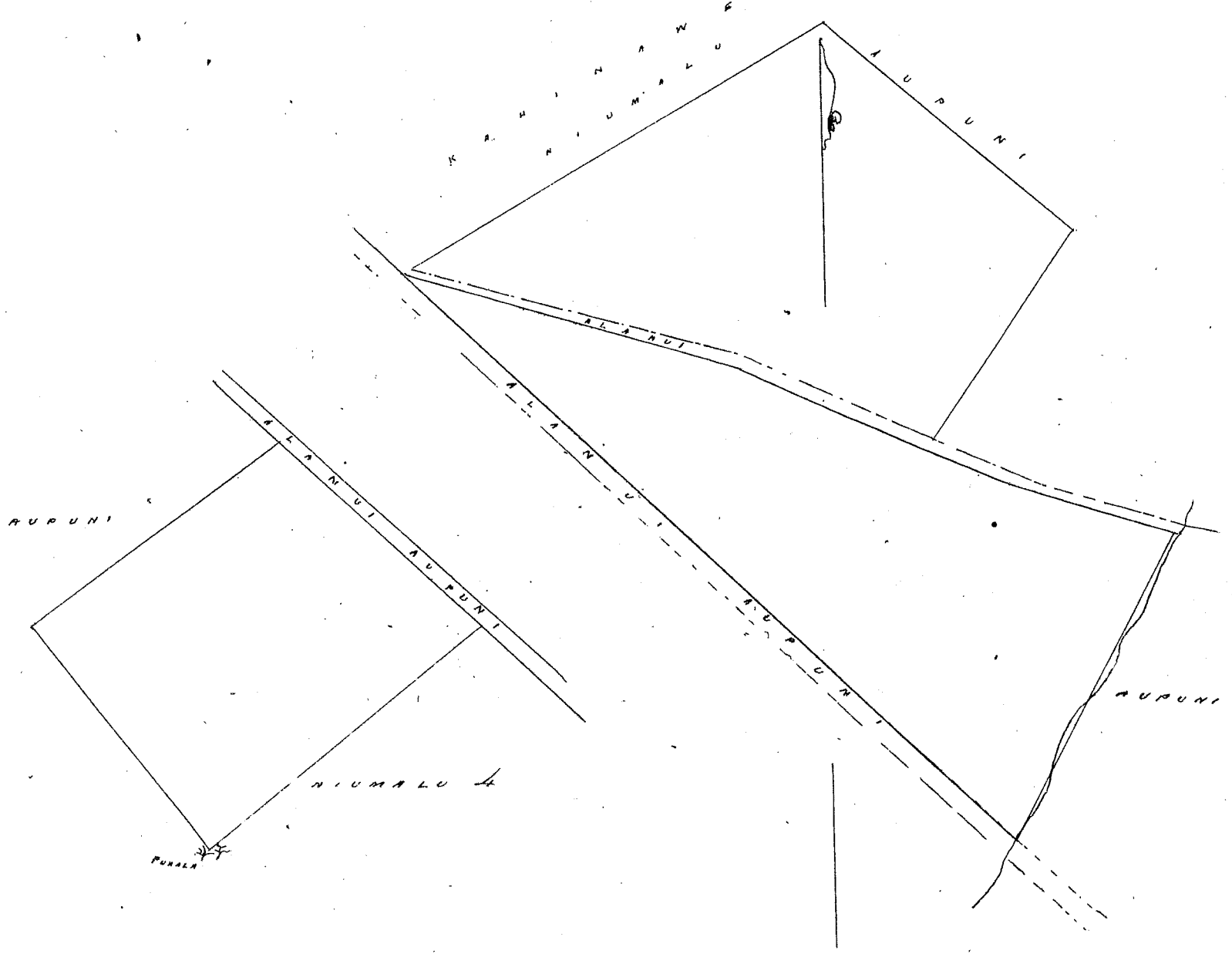

Wm. Pau Lon #11.
W. L. Lee
G. M. Robertson
J. Kikaulahao
J. H. Smith

Honolulu 1 Sep 1852

Heleu 4534 Ulumakele

Kawaiipapa Hana Maui

Ulumakele Polikane Kawaiipapa Hana Maui.

Kiu E hoomaka ana ma ke Pihia Hana a e holo ana, Hem 42° No. 360 pauku e pili
ana, i ke Aupuni, AK. 30° No. 256 pauku e pili ana i ke Aupuni, AK. 42, No. 216 pauku
e pili ana i ke Aupuni, Hem 63° No. 256 pauku e pili ana ma ke Alanui Aupuni i ke
Pihia mua, 7/10 Eka,

"20 Sep 1852" A. F. Turner,
Luna Ana Aina,

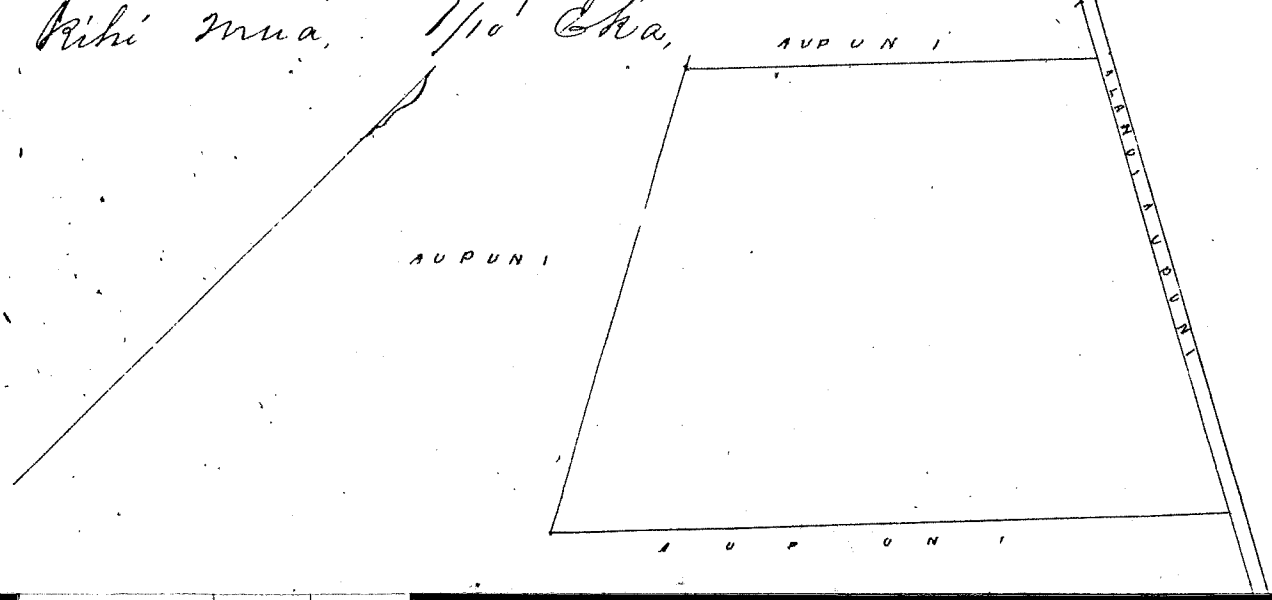

Uku Pau Loa # 4
W. L. Lee
G. M. Robertson
S. Kekaulahao
S. H. Smith

Honolulu 1 Sept 1852

Helu 4853 Kawaiaoa

Maiahole Kaitiaki Maui

E hoomaka ana ma ke kīhi kīkina Akau a e holo ana, kōkoke i ke Kahawai, Ak 75° Ke, 4,10 pautu e pili ana i ke Aupuni, Hem. 26½ Ke, 4,70 pautu e pili ana i ke Kahawai, Hem. 27° Ke, 11,24 pautu e pili ana i ke Kahawai, Hem. 18° Ke 547 pautu e pili ana i ke Kahawai, Hem. 82 Ke, 190 pautu e pili ana i ke Aupuni ma ke Kahawai, alaila e pili ana i ke Kahawai i ke kīhi mua 1½ Eka
20 April, 1852.

A. F. Turner,
Luna ana aina

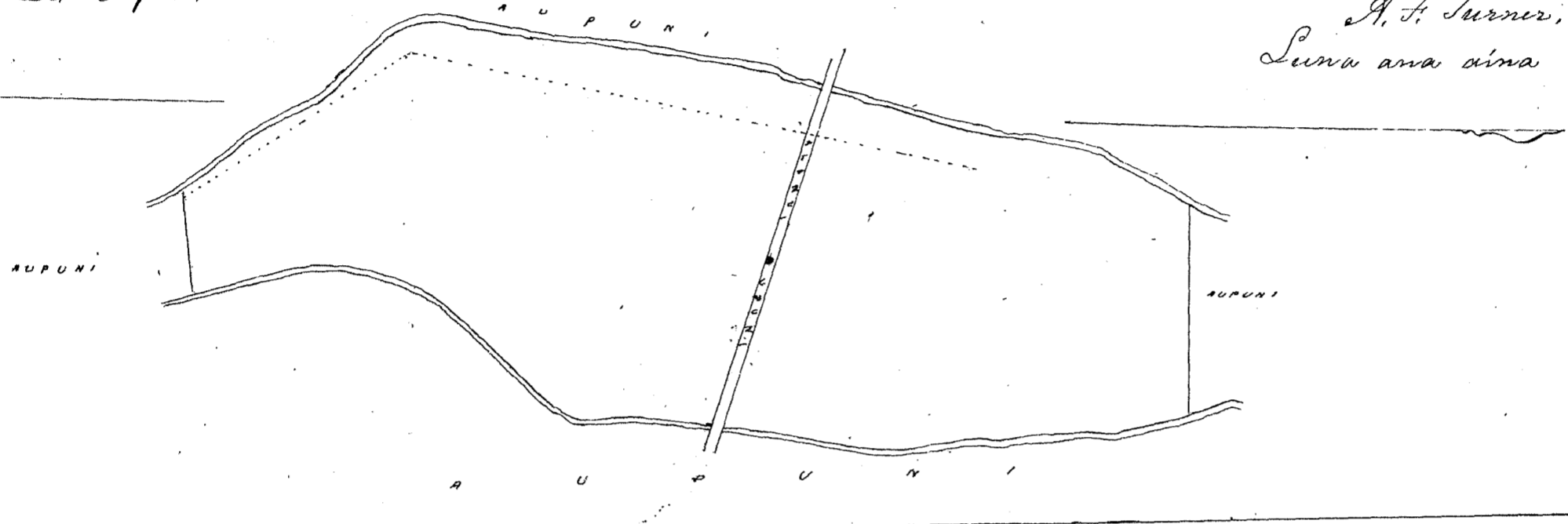

Uku Pau Loa # 10 W. L. Lee

S. H. Smith
G. M. Robertson
S. Kekaulahao

Honolulu 1 Sept 1852

Helu 4736 Maakee

Palema Aana Maui

Ki. O. Spuole,

Apana 1 E hoomaka ana ma ke kīhi kīkina Akau, a e holo ana Hem. 44° Ke, 10,65 pautu e pili ana i ke Puki, Ak 34½ Ke, 1,95 pautu e pili ana i ke Alanui Aupuni, Ak 43° Ke, 9,40 pautu e pili ana i ke Aupuni Hem. 84° Ke 2½ pautu e pili ana i ke Paahao i ke kīhi mua, 2 Eka,

Apana 2, E hoomaka ana ma ke kīhi Akau a e holo ana Ke, 20° Ke, 1,70 pautu e pili ana i ke Aupuni, Hem. 60½ Ke, 4,17 pautu e pili ana i ke Aupuni Hem. 58½ Ke, 7,00 pautu e pili ana i ke Aupuni ma ke Kahawai alaila e pili ana i ke Kahawai i ke kīhi mua 1½ Eka,

13 April 1852,

A. F. Turner
Luna ana aina

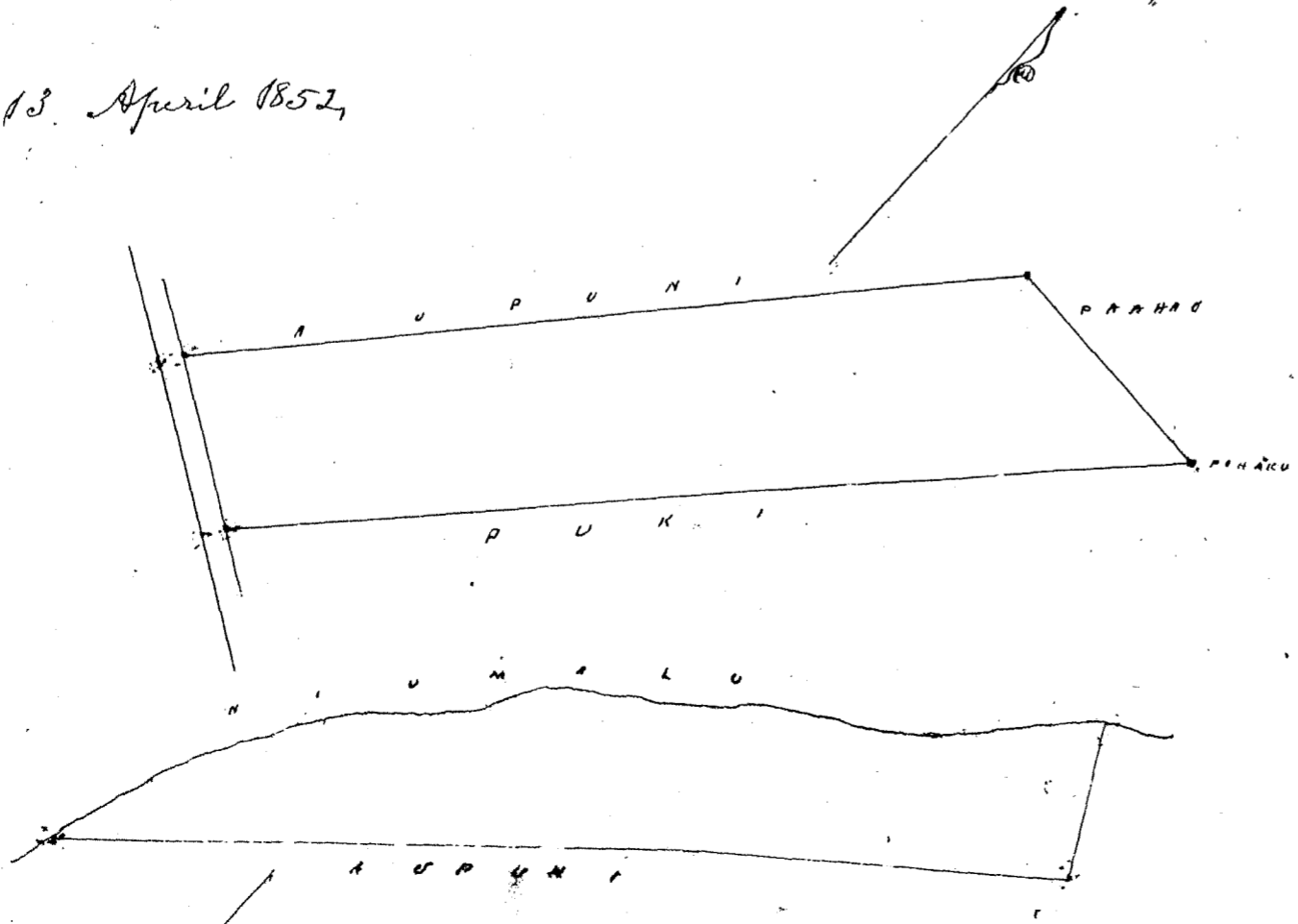

Wku Pau Loa # 6
W. L. Lee

G. M. Robertson
J. Kaulahao
J. H. Smith

Honolulu 1 Sep 1852

Heleu ~~12992~~ Uhai 2986^B

Ahuakamalii Kana Maui

Palulu. E hoomaka ana ma ke kahi Komohana Kama a e holo ana Ah. 86° Ki. 270
pauku e pili ana i ke EP Judd. Ah. 3° Ki. 247 pauku e pili ana i ke Alanui; Ah. 80° Ki. 295
pauku e pili ana i ke G. P. Judd. Ah. 10° Ki. 215 pauku e pili ana i ke Alanui; Ah. 100°
i ke kahi mua. 65/100 Eha.
12 April 1852.

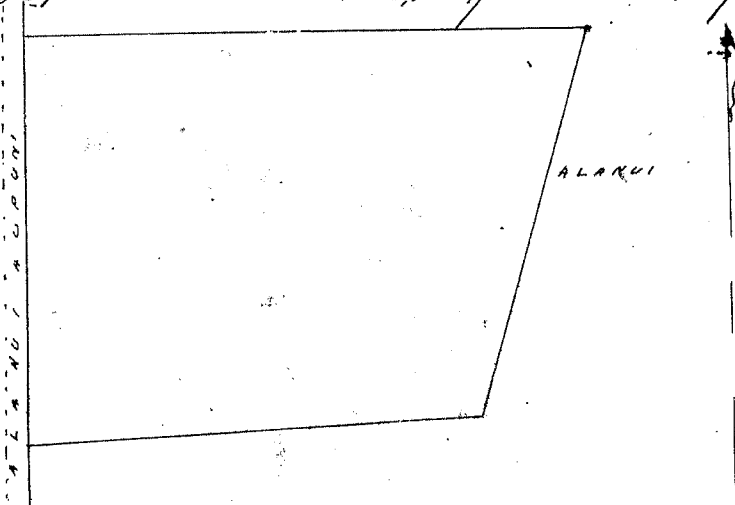

A. F. Turner
Luma ana aina

Wku Pau Loa # 6
W. L. Lee

G. M. Robertson
J. Kaulahao
J. H. Smith

Honolulu 1 Sep 1852

Heleu 10155 Moa

Papaauana Kipahulu Maui

Ili o Kapahulu E hoomaka ana ma ke kahi Kama a e holo ana Ah. 33° Ki. 450
pauku e pili ana i ke Kala; Ah. 10° Ki. 224 pauku e pili ana i ke Kala; Ah. 49° Ki. 264 pauku
Ah. 39° Ki. 200 pauku e pili ana i ke Alanui Ah. 73° Ki. 585 pauku e pili ana i ke Ala
nuui Ah. 16 1/2° Ki. 419 pauku e pili ana i ke Konoehiki Ah. 15° Ki. 470 pauku e pili ana
i ke Konoehiki i ke kahi mua 39/100 Eha

18 April 1852

A. F. Turner
Luma ana aina

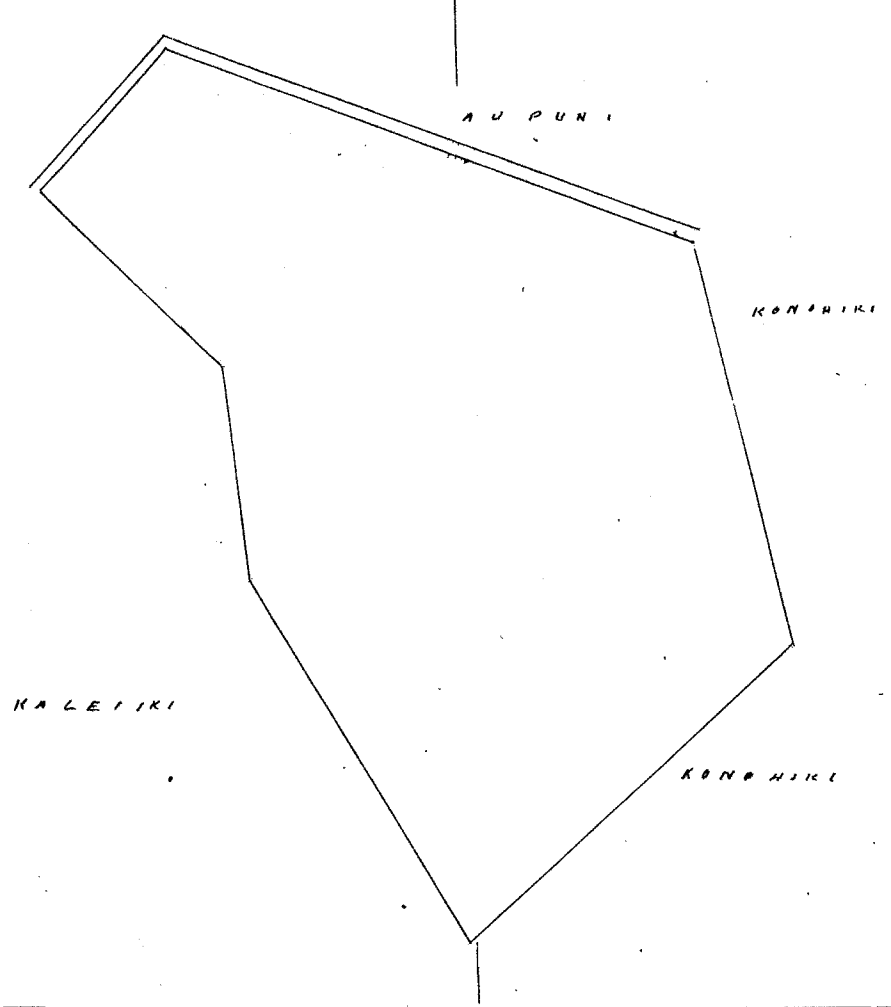

Wku Pau Loa # 6
W. L. Lee

G. M. Robertson
J. Kaulahao
J. H. Smith

Honolulu 1 Sep. 1852

Heleu 7789 Iiwiniui

Wailamoa Kipahulu Maui

Iwiniui ma Wailamoa Kipahulu Maui.

Hi. Papala E hoomaka ana ma ke kahi Kama, a e holo ana, Ak. 71 ki 514 pauten e pili ana i ke Kahi-hi Ak. 27, No. 2380 pauten e pili ana me Mahoe Ak. 23 1/2 No 1150 pauten e pili ana i ke Puniawa Sem. 5th No. 237 pauten e pili ana i ke Puaa Sem 6 1/4 ki 6,75 pauten e pili ana i ke Halemano Sem. 20 ki 2,770 pauten e pili ana i ke Halemano, I ke kahi onua, 18 3/4 Eka,

A. F. Turner,
Luna ana aina

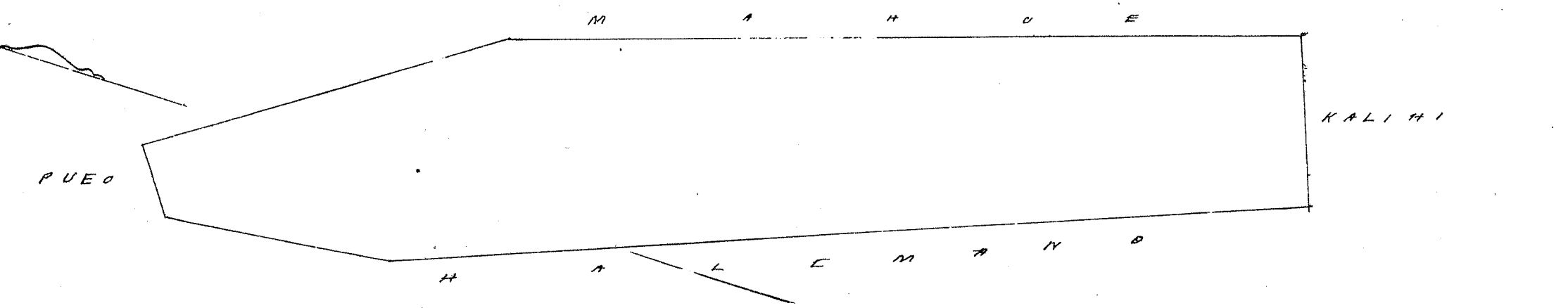

Wm. Pau Loa #2
W. L. Lee

G. M. Robertson
J. Kekaulahao
J. H. Smith

Honolulu, 1. Sep 1852

Heleu 2986 Laaupau

Ahuakamali Aana Maui

E hoomaka ana ma ke kahi Kikina Kama, a e holo ana, Ak. 86 No. 1370 pauten e pili ana i ke Ihuula (Ak.) Ak. 4 No. 450 pauten e pili ana i ke A. B. Howe, Ak. 75 No. 1206 pauten e pili ana i ke A. B. Howe, Sem. 16 ki 890 pauten e pili ana i ke Alanui Aupuni I ke kahi onua, 8 2/100 Eka

12th 1852 April

A. F. Turner,
Luna ana aina

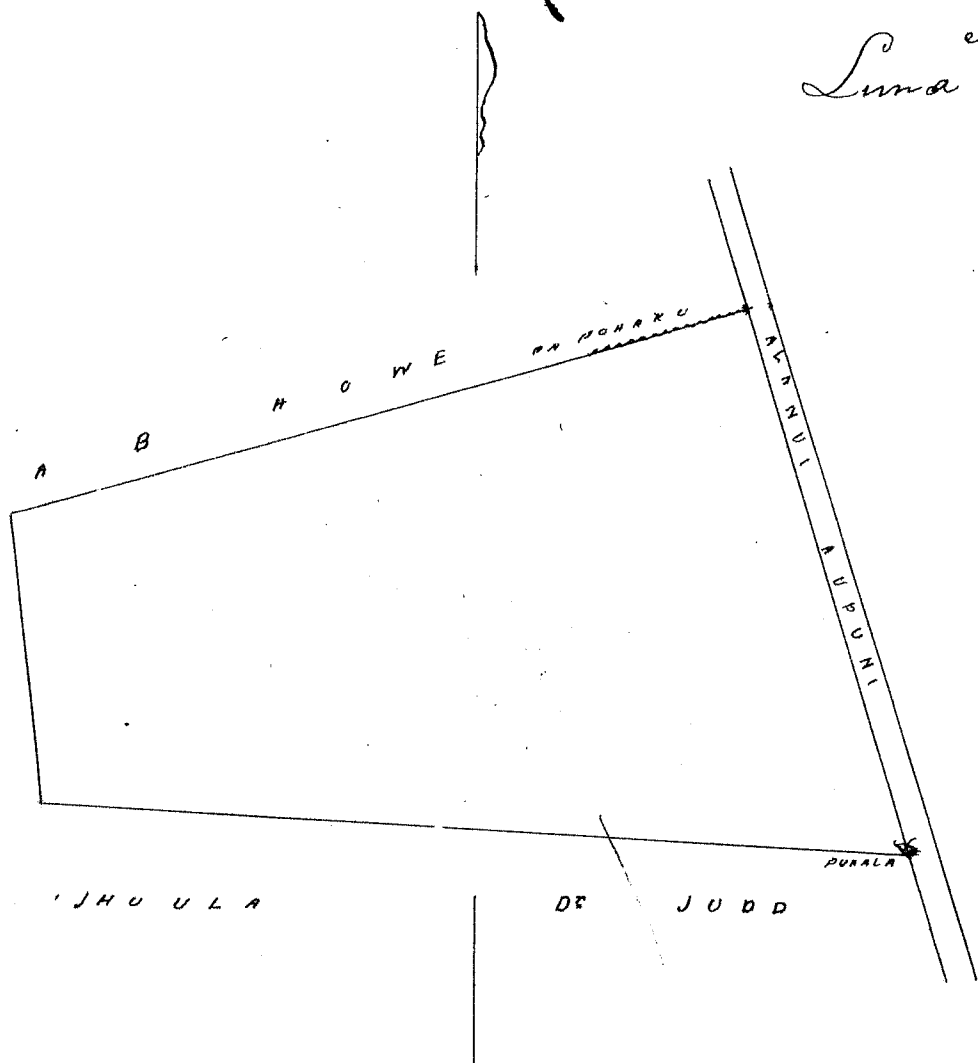

Wm. Pau Loa #8
W. L. Lee

G. M. Robertson
J. Kekaulahao
J. H. Smith

Honolulu, 1. Sep. 1852

Heleu 4849. Koolohelau

Makapipi Koolau Maui

Aprana 1 Pahale ma Makapipi

E hoomaka ana ma ke kahi kama, a e holo ana, Ak 76° Hi. 480 pautu e pili ana i ke Alanui Aupuni; Ak 6° Hi. 5.28 pautu e pili ana me Makua, Ak 73° Hi. 4.60 pautu e pili ana i ke Aupuni, ma ke Kahawai alaila e pili ana i ke Kahawai i ke kahi mua 2 1/2 Eka

Aprana 2, Ili o Kaahumanamana Makapipi

E hoomaka ana ma ke kahi Komohana Akau a e holo ana Ak 83° Hi. 479 pautu e pili ana i ke Ili o Waawaa, Ak 5° Hi. 708 pautu e pili ana i ke Ili o Waawaa, Ak 87° Hi. 186 pautu e pili ana i ke Kahi Ak Hi. 257 pautu e pili ana i ke Makua, Ak 3 1/2° Hi. 808 pautu e pili ana i ke Kaomoaiki ma kekahi puka i ke kahi mua 2 1/10 Eka

Aprana 3 Kahi ma Kahaka Huikahi (Ak)

E hoomaka ana ma ke kahi Ak. Kom. a e holo ana, Ak 8° Hi. 1500 pautu e pili ana i ke Aupuni, Ak 68° Hi. 336 pautu e pili ana i ke Kahi Ak. 6 1/2° Hi. 1335 pautu e pili ana i ke Kahaka Ili; Ak 85° Hi. 381 pautu e pili ana i ke Alanui Aupuni, i ke kahi mua 5 Eka.

Aprana 4, 2 Ili ma Honolulu

E hoomaka ana ma ke kahi Akau a e holo ana, Ak 8° Hi. 350 pautu e pili ana i ke Puaka Ak 87° Hi. 148 pautu e pili ana i ke Kahaka Ak. 15 1/2° Hi. 277 pautu e pili ana i ke Kauhalaau Ak. 68° Hi. 120 pautu e pili ana i ke Hanana i ke kahi mua 4 1/10 Eka

2.20
2.10
5
4.10
13.40

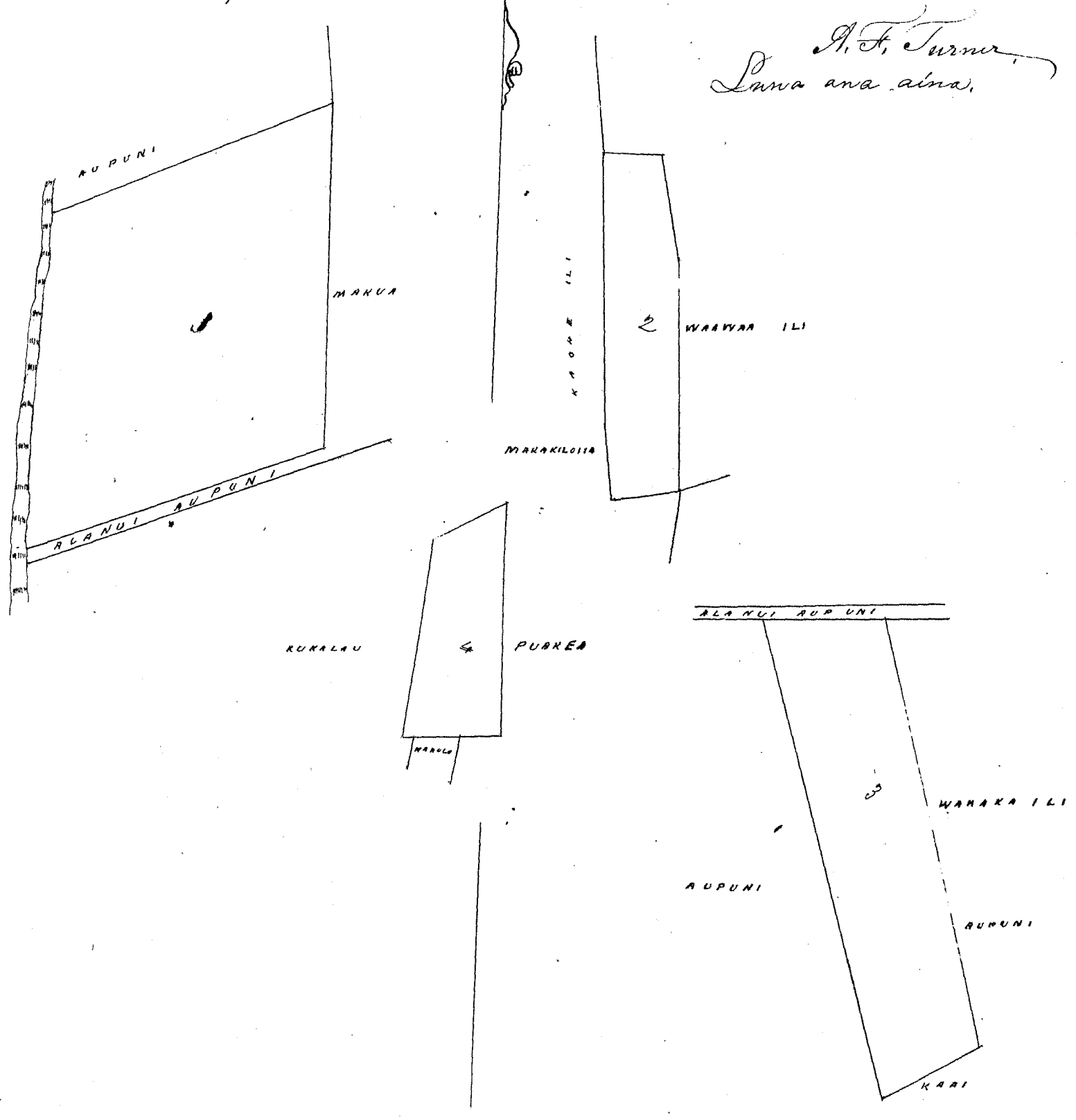

Wku Pau Loa 9
Maka

G. M. Robertson
J. H. Smith
J. Hekeaulahas

Honolulu 1 Sep 1852

Heleu 2965 Puhii

Ataneo Aana Maui

Puhii ma Hinamaha Ataneo
E hoomaka ana ma ke Puhii Akau, a e holo ana, hem. i. No 6.12 pautu
e pili ana i ke Keko. Hem. 8 7/8 Ni; 11.75 pautu e pili ana i ke Keko. Ak 6°
Ni 400 pautu e pili ana i ke Koalakahii Ak 78° No 1230 pautu e pili
ana i ke Kaumuku, i ke Puhii maui 5 9/10 Eka

7 April 1852

A. F. Turner,
Luna ana aina.

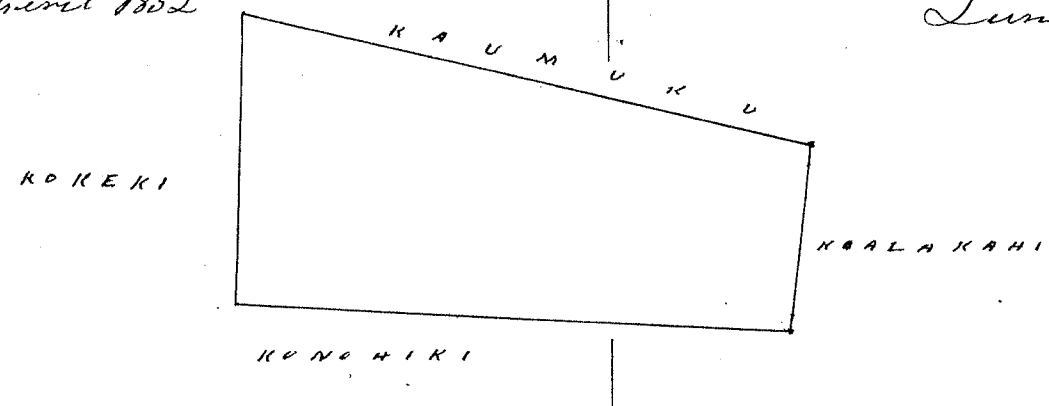

Uku Pau Loa # 7

W. L. Lee
G. M. Robertson
J. H. Smith
J. Kekaulaha

Honolulu, Sep 1, 1852

Heleu 5004 Kahele

Kailamaa Kipakahi Maui

Apana 1 Ihi, Lolo
E hoomaka ana ma ke Puhii Aema, a e holo ana Ak 37° No 1850 pautu e pili ana i ke
Kanoa, Ak 70° Ni 514 pautu e pili ana i ke Awiniu Hem. 37° Ni; 16.25 pautu e pili
ana i ke ke Aupuni; Hem. 25° No 502 pautu e pili ana i ke Kapakahi; i ke Puhii maui 5 9/10 Eka

Apana 2 Pahale ma Iliilipoko
E hoomaka ana ma ke Puhii Aema a e holo ana Ak 47° No 335 pautu e pili ana i ke
Aupuni; Ak 40° Ni 290 pautu e pili ana i ke Aupuni Hem 40° Ni; 297 pautu e
pili ana i ke Aupuni; Hem. 23° No 250 pautu e pili ana ia Aiape i ke Puhii
maui 9 1/10 Eka

18 March 1852

A. F. Turner,
Luna ana aina

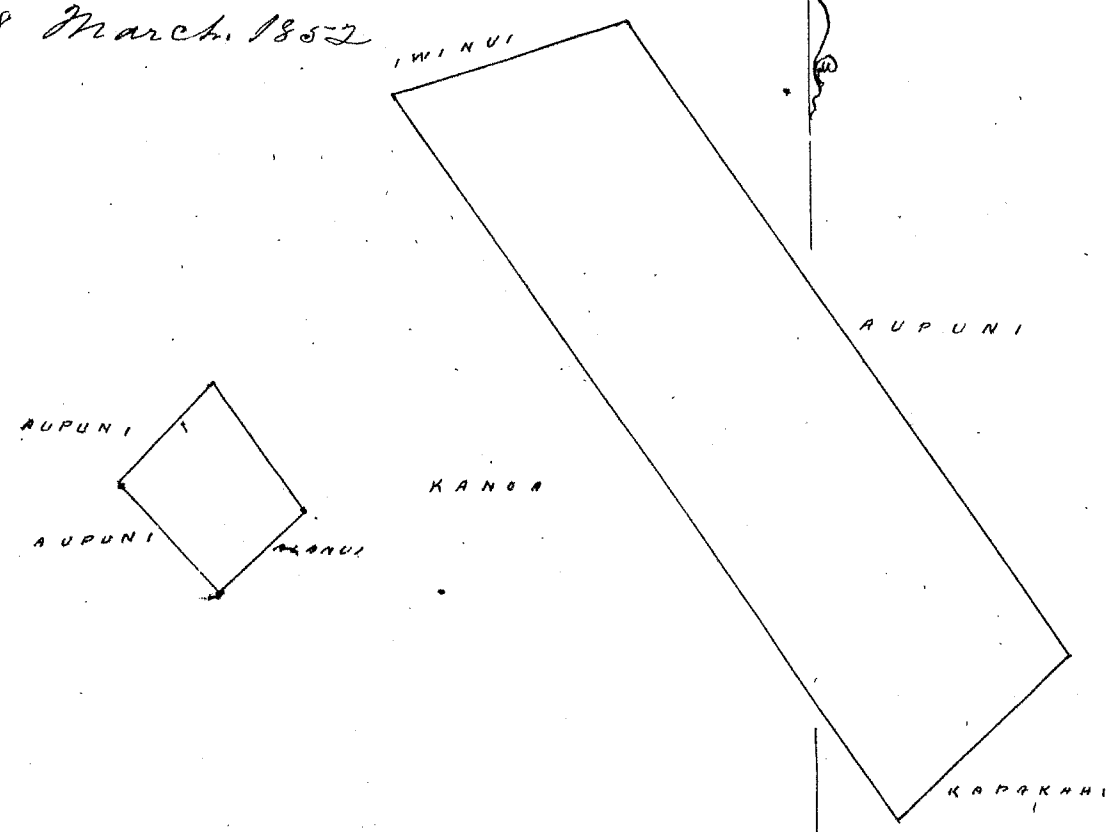

Uku Pau Loa # 9

W. L. Lee
G. M. Robertson
J. Kekaulaha
J. H. Smith

Honolulu 1, Sep 1852

Apana 1. Kula ma Hukuihanau

Chomaka ana ma ke Kihiki Aka, a e holo ana, Hem 64 1/2' Ki. 240 pautu e pili ana i ke Kahuluwai Hem. 34' Ki. 178 pautu e pili ana me ke Mahiai Ak. 57 1/2' Ki. 320 pautu e pili ana i ke Honohiki Ak. 60' Ki. 175 pautu e pili ana i ke Honohiki i ke Kihiki mua 44/100 Eka

Apana 2. Kula ma Hukuihanau

Chomaka ana ma ke Kihiki Aka, a e holo ana, Hem 72' Ki. 552 pautu e pili ana i ke Kaitau Hem. 26' Ki. 156 pautu e pili ana i ke Paale Ak. 78' Ki. 528 pautu e pili ana i ke Honohiki Ak. 18' Ki. 200 pautu e pili ana i ke Honohiki i ke Kihiki mua. 94/100 Eka

Apana 3. Kula ma Pahakiloa

Chomaka ana ma ke Kihiki Aka, a e holo ana, Hem. 88' Ki. 503 pautu e pili i ke Ahami Hem. 10' Ki. 285 pautu e pili ana i ke Honohiki Ak. 88 1/2' Ki. 510 pautu e pili ana i ke Honohiki Ak. 11' Ki. 320 pautu e pili ana i ke Honohiki i ke Kihiki mua. 1 1/2 Eka

Apana 4. Kula ma Pele

Chomaka ana ma ke Kihiki Aka, a e holo ana Hem. 34' Ki. 538 pautu e pili ana i ke Honohiki Ki Hem. 82 1/2' Ki. 375 pautu e pili ana i ke Honohiki, Ak. 45' Ki. 340 pautu e pili ana i ke Honohiki Ak. 50' Ki. 403 pautu e pili ana i ke Honohiki i ke Kihiki mua 1/100 Eka

Apana 5 Kula ma Hukuihanau, Chomaka ana ma ke Kihiki Aka a e holo ana, Hem 76' Ki. 300 pautu e pili ana i ke Honohiki Hem 8 1/2' Ki. 320 pautu e pili ana i ke Honohiki Ak. 8 1/2' Ki. 300 pautu e pili ana i ke Honohiki Ak. 8 1/2' Ki. 358 pautu e pili ana i ke Honohiki i ke Kihiki mua 1 03/100 Eka

4 Feby 1852

A. J. Turner
Lima ana aina

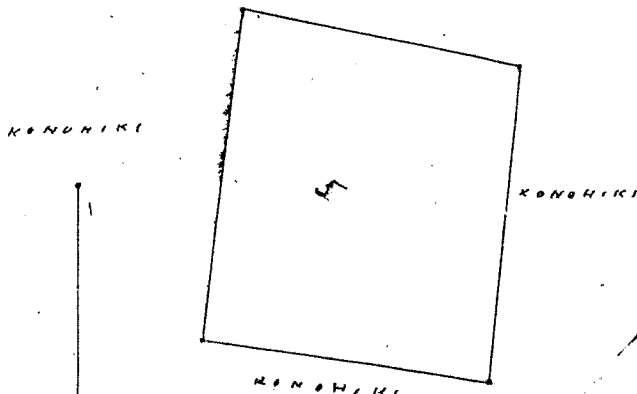
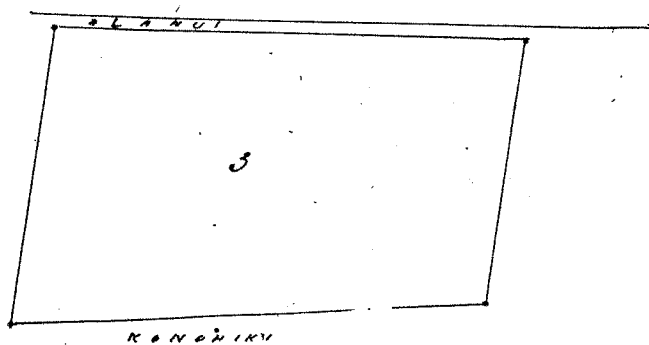
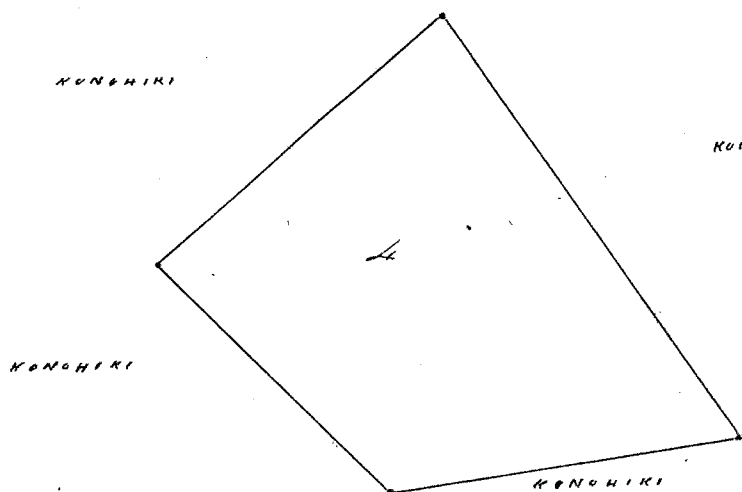
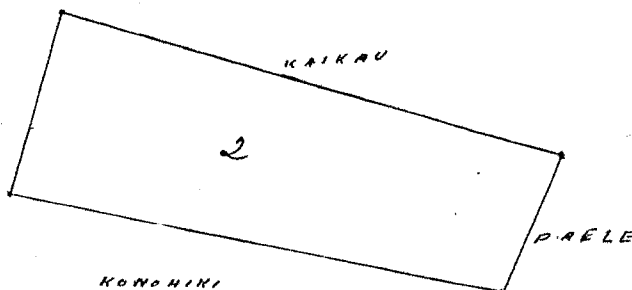
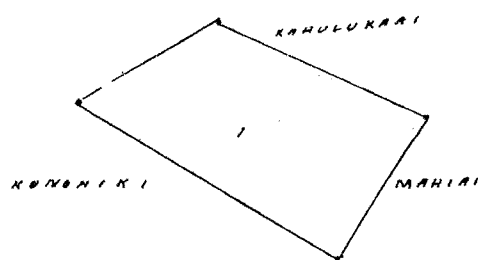

Uku Pau Loa # 6
W. L. Lee
G. M. Robertson
J. N. Kaulahao

Honolulu 1 Sep 1852

J. H. Smith

Heleu 4510 Kuaali

Halemano Kipahulu Maui

Kuaali Ii. Paiki Halemano Kipahulu Maui
E hoomaka ana ma ke kahi kema a e holo ana Ak. 65. Ni. 420 pautu e pili ana i ke Konoehiki
Ak. 23 1/2 Ni. 1930 pautu e pili ana me ke Halemano Ak. 27 Ni. 1085 pautu e pili ana
me Halemano Ak. 52 Ni. 926 pautu e pili ana i ke Halemano Hem. 24 Ni. 290 pautu e
pili ana i ke Konoehiki Hem 27 1/2 Ni. 3640 pautu e pili ana i ke Palale, i ke kahi mua
1926/100 Eka

18 March 1852

A. F. Turner
Luma ana aina

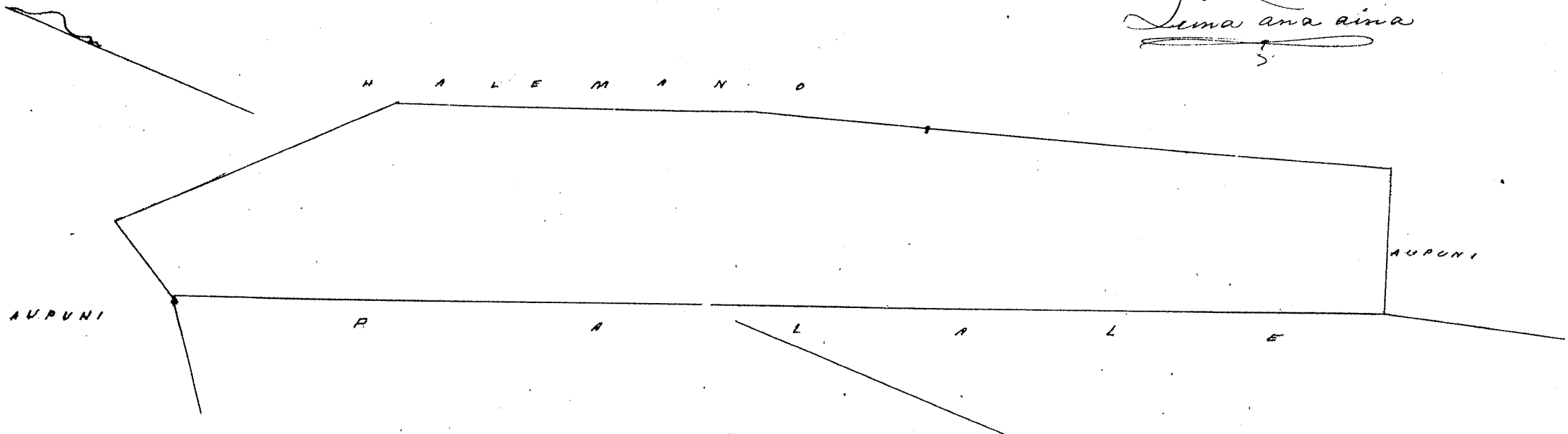

Uku Pau Loa # 12
W. L. Lee
G. M. Robertson
J. N. Kaulahao
J. H. Smith

Honolulu 1 Sep 1852

Heleu 5376 Lono

Koonoulu Kuba Maui

Apana 1. Kula ma Koonoulu Koonoulu Kuba Maui E hoomaka ana ma ke kahi Akau, a e
holo ana Hem 30 Ni. 610 pautu e pili ana i ke Konoehiki Hem. 50 Ni. 418 pautu e pili ana
i ke Konoehiki Ak. 25 Ni. 504 pautu e pili ana i ke Konoehiki Ak. 15 Ni. 405 pautu e pili ana
i ke Konoehiki i ke kahi mua, 2 1/100 Eka.

Apana 2. Pahale ma Kalepolopo Koonoulu E hoomaka ana ma ke kahi
kema, a e holo ana, Ak. 82 Ni. 52 pautu e pili ana i ke Kai, Ak. 40 Ni. 43 pautu e
pili ana i ke Alanui Hem. 82 Ni. 52 pautu e pili ana i ke J. Halstead Hem. 10 Ni. 43
pautu e pili ana i ke Kauhukulani i ke kahi mua 27 awana

10 Feb 1852

A. F. Turner
Luma ana aina

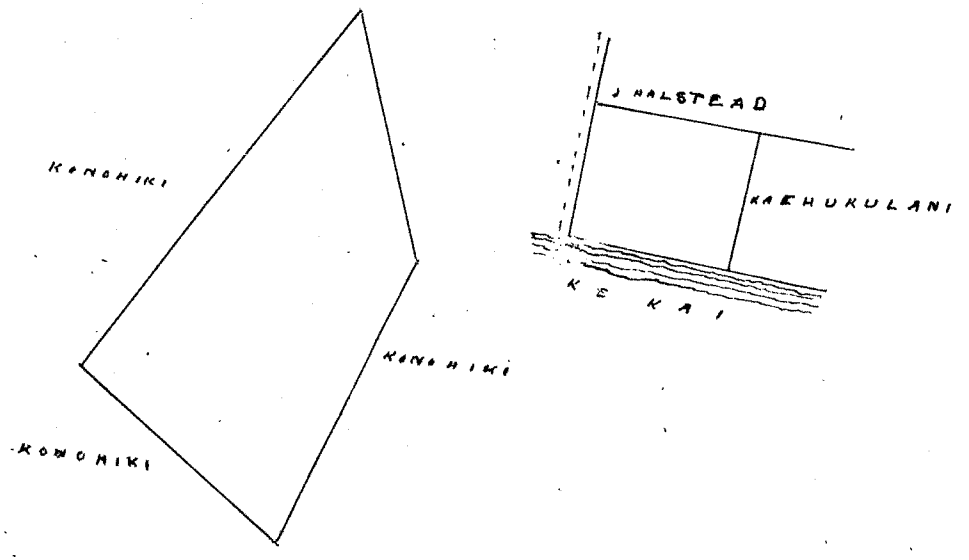

Uku Pau Loa # 5
W. L. Lee
G. M. Robertson
J. Kikauakua
J. H. Smith

Honolulu 1 Sep 1852

Kolu 2965^B Koamule

Kanaka Kama Maui

Apana 1 Ili. Kaulapaapapa.

Chomaka ana ma ke kahi Hikinana Kama, a e holo ana. Ak 70° Ko 2240 pautu e pili ana i ke Poo, Ak. 28° Ki. 715 pautu e pili ana i ke Konoehiki Kama, 66 1/2. Ki. 13,90 pautu e pili ana i ke Konoehiki, Kama. 4. Ki. 650 pautu e pili ana i ke Kamaui Kupuui i ke Kahi mua 13, 22/100 Eka.

Apana 2 Ili. Kapahuniu

Chomaka ana ma ke kahi Komoana Kama, a e holo ana. Kama. 86. Ki. 1180 pautu e pili ana i ke Kupuui Kama. 17. Ki. 364 pautu e pili ana i ke Konoehiki Kama, 86. Ko. 1168 pautu e pili ana i ke Konoehiki i ke Kahi mua, 4, 88/100 Eka.

12 April, 1852.

A. F. Turner
Luna ana aina

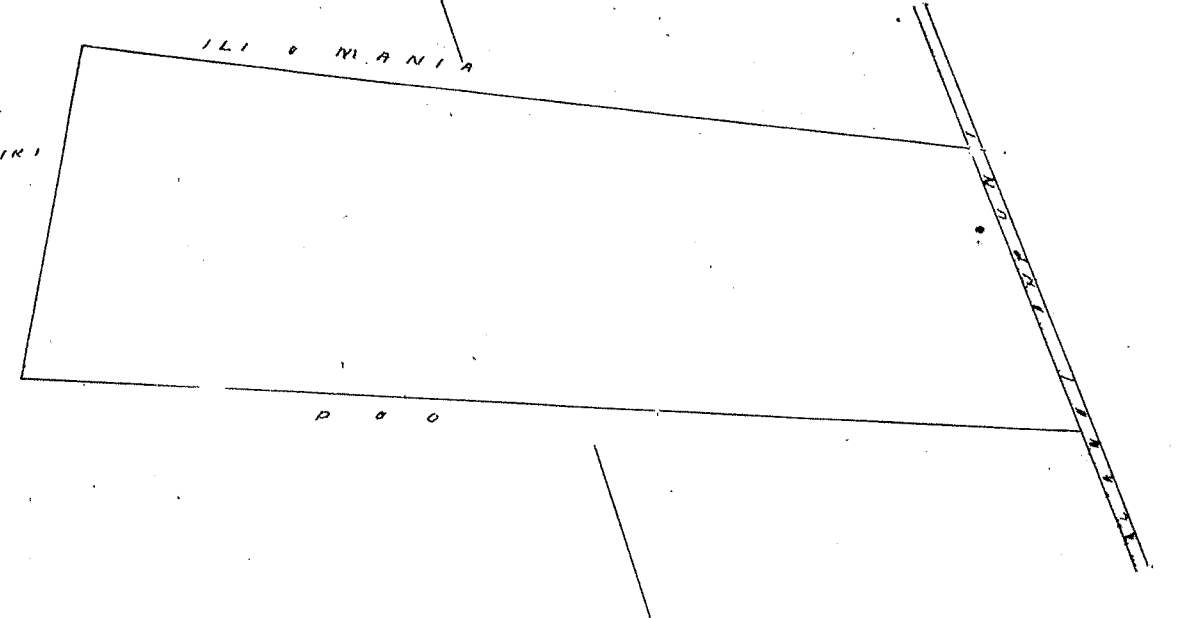
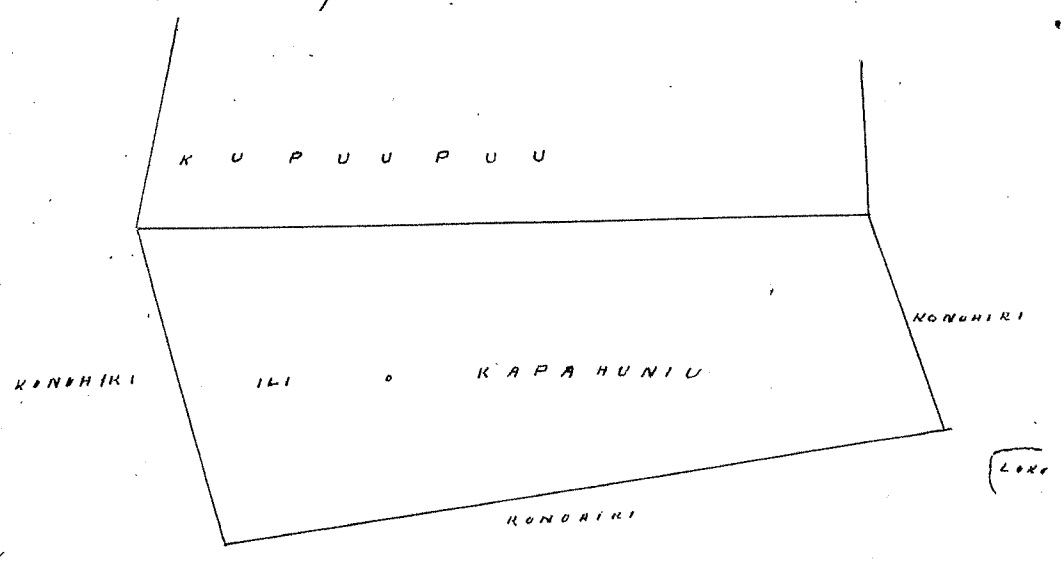

13-22
488
1810

Uku Pau Loa # 12.
W. L. Lee

G. M. Robertson
J. Kikauakua
J. H. Smith

Honolulu 1 Sep 1852

Kolu 4670^B Koke

Kanaka Kama Maui

Apana 1. Ili. Kumaikawa Chomaka ana ma ke kahi Hikinana Kama, a e holo ana. Kama. 81° Ko. 1520 pautu e pili ana i ke Kapuhi, Kama. 11. Ki. 200 pautu e pili ana i ke Konoehiki Ak. 87 1/2° Ki. 1120 pautu e pili ana i ke Pua ma ke Kahaui e pili ana i ke Kahaui i ke Kahi mua 3 1/2 Eka

Apana 2. Chomaka ana ma ke kahi Komoana Kama a e holo ana. Ak. 83 3/4° Ki. 885 pautu e pili ana i ke Konoehiki Ak. 8° Ki. 360 pautu e pili ana i ke Keki Ak. 84° Ko. 880 pautu e pili ana i ke Kepuhi Kama. 6° Ko. 550 pautu e pili ana i ke Pua, i ke Kahi mua 4 18/100 Eka
14 April 1852

A. F. Turner
Luna ana aina

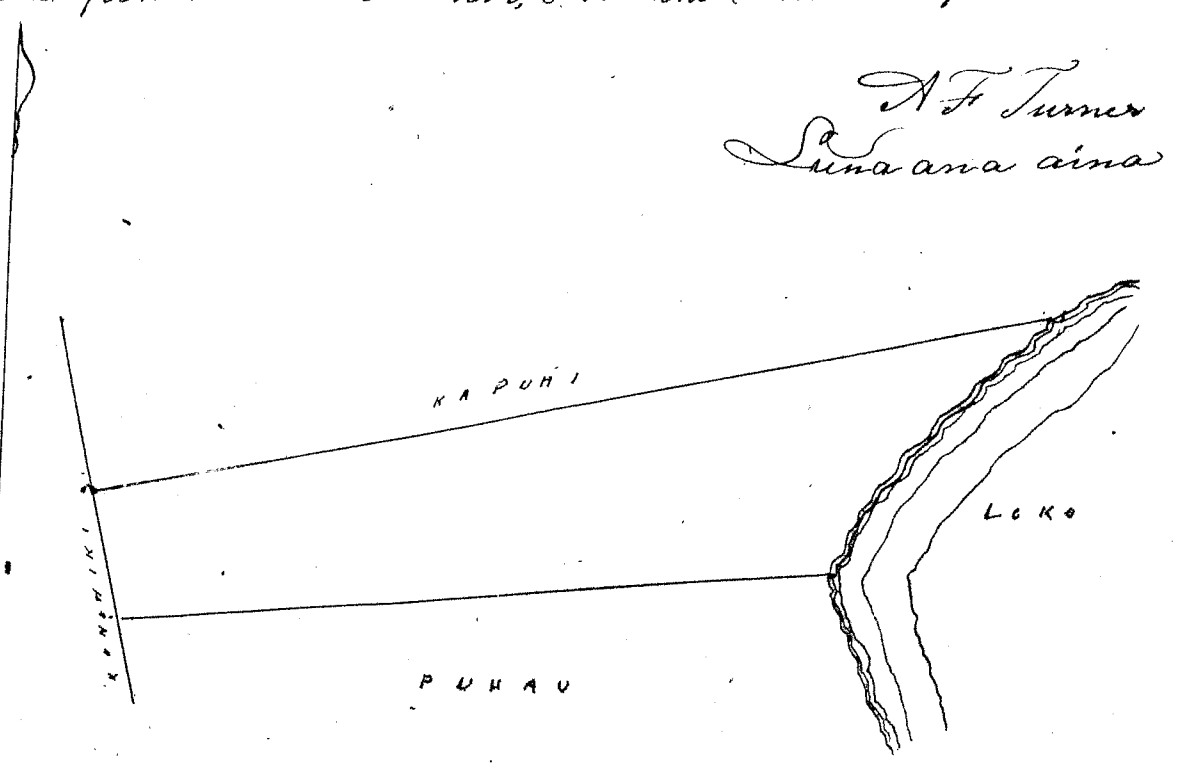
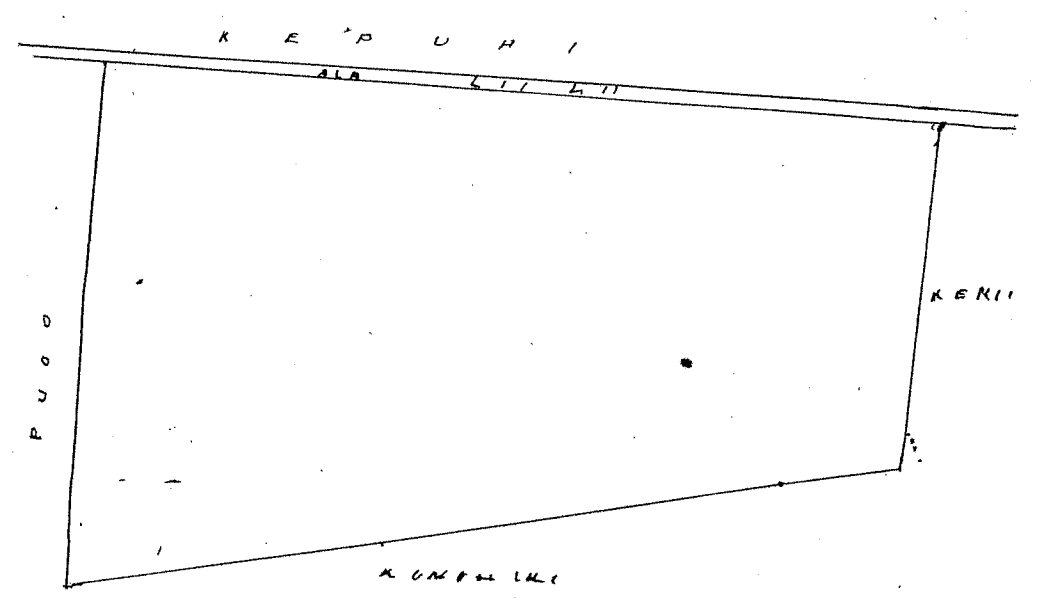

Wku Pau Loa # 8
N. S. Her

G. M. Robertson
J. Kikaulaha
J. H. Smith

Honolulu 1 Sep 1852

Keolu 3108 Konoia

Waioli Kula Maui

Apawa 1 Aua ma Pua Chromaka ana ona ke kahi Aka, a e holo ana, kem. 7, No. 176 paunū e pili ana i ke Konoiki kem. 29, No. 246 paunū e pili ana ma Paie kem 83' ki. 950 paunū e pili ana i ke Alani, Ak. 12' ki. 250 paunū e pili ana ma Paie, Ak. 78 1/2' No. 870 paunū e pili ana ma Konoiki i ke Kahi mua, 1 3/4 Eka.

Apawa 2. Kula ma Waioli Chromaka ana ona ke kahi Aka, a e holo ana, kem. 78 ki. 632, paunū e pili ana i ke Konoiki kem. 5 No. 308, paunū e pili ana i ke Paie, kem. 79, No. 378 paunū e pili ana i ke Aaa, kem. 86, No. 320, paunū e pili ana i ke Aaa, Ak. 10, ki. 50 paunū e pili ana, i ke Paia, i ke kahi mua 2 1/2 Eka.

L. Feb 1852.

A. F. Turner,
Luna ana aina

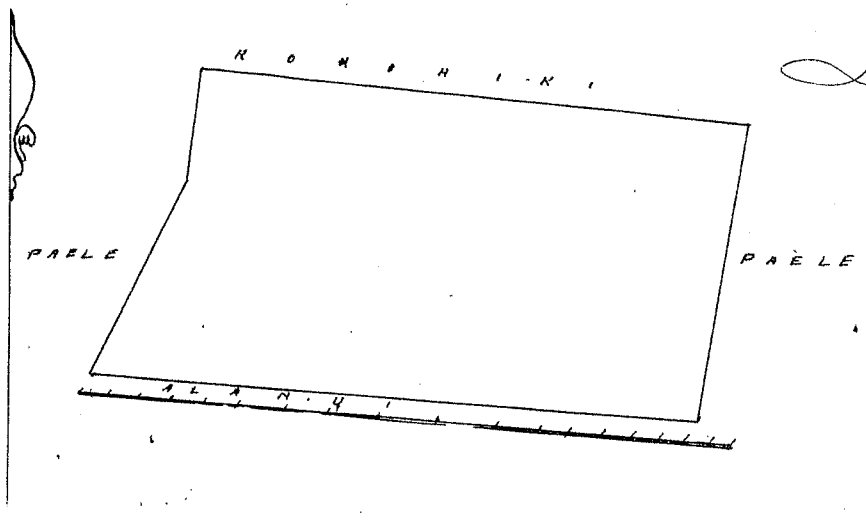
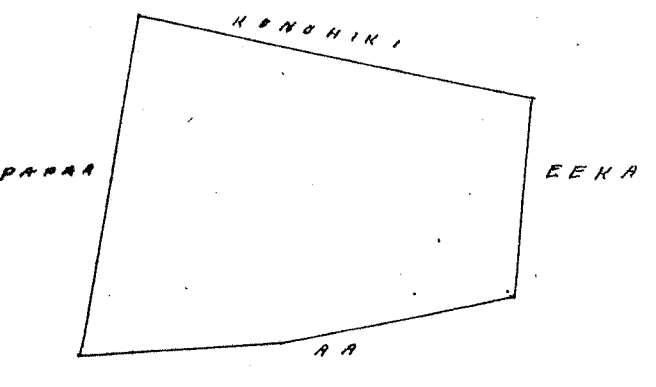

Wku Pau Loa # 7
N. S. Her

G. M. Robertson
J. Kikaulaha
J. H. Smith

Honolulu 1 Sep 1852

Keolu 5037 Kapa

Wailama Kipahulu Maui

Ihi o Aua Wailama Kipahulu Maui Chromaka ana ona ke kahi Aka a e holo ana, Ak. 41 1/2' No. 940 paunū e pili ana i ke Pihoni Ak. 40, ki. 120, paunū e pili ana i ke Lupe Ak. 53, ki. 429, paunū e pili ana i ke Lupe kem. 46 ki. 730 paunū e pili ana i ke Mahoe, kem. 32 1/2' ki. 330, paunū e pili ana i ke Mahoe, kem. 62' No. 550 paunū e pili ana i ke i ke Nahalewalani i ke kahi mua 5 3/4 Eka.

20. April 1852.

A. F. Turner,
Luna ana aina

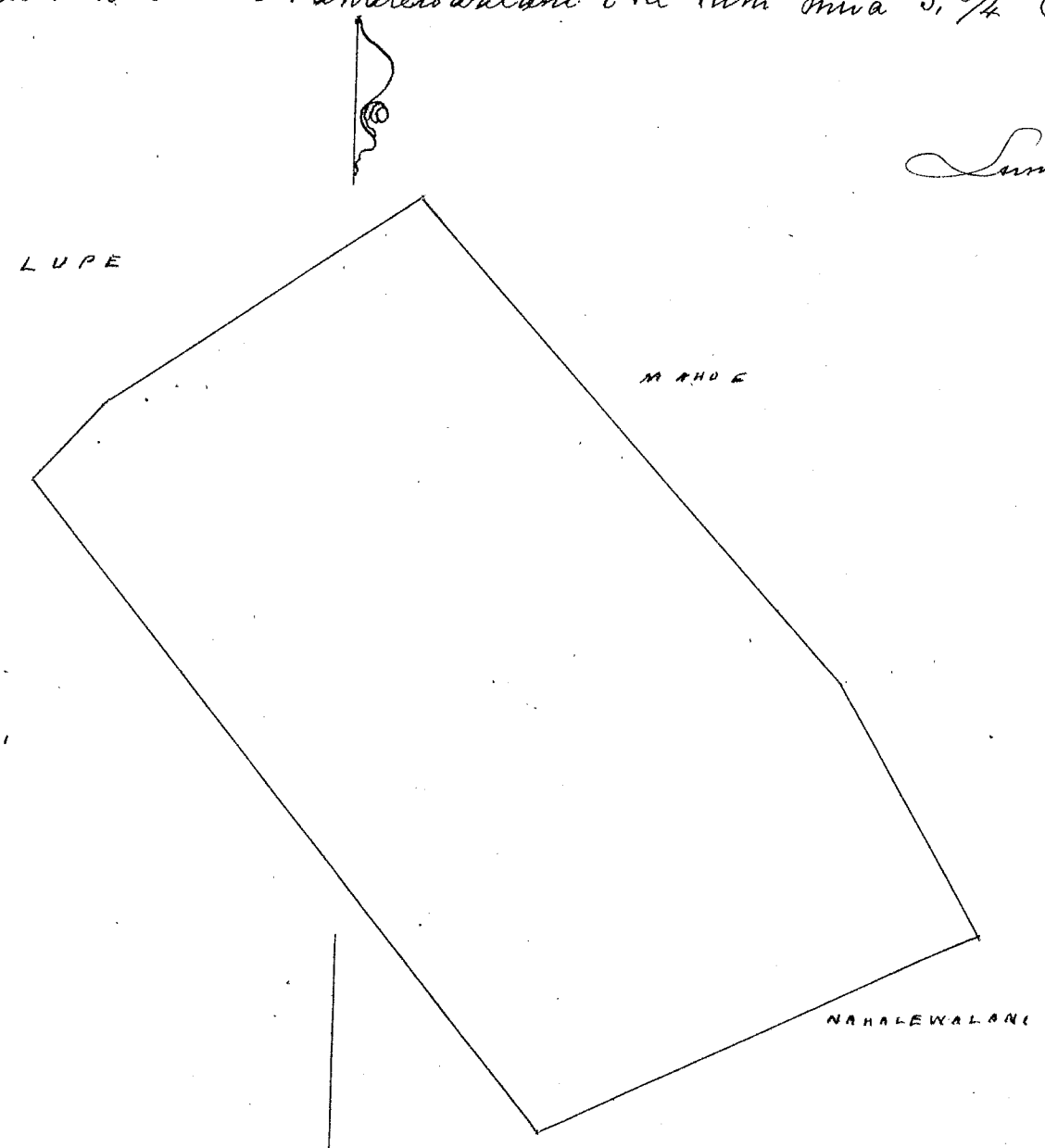

Wm Pau Loa #7
W. L. Lee
G. M. Robertson
C. Kikaula
J. H. Smith

Honolulu 1 Sept 1852

Kolu 4741 Kolu

Makaalae Aana Maui

Melu ma Kahukahukaapu Makaalae, Aana ma Maui
E hoomaka ana ma ke Pihik Homohana Ima, a e holo ana, Ak. 10° No. 550 pautu e pili ana i ke Aupuni
Ak. 82° No. 245 pautu e pili ana i ke Aupuni, Ak. 76 1/2° No. 827 pautu e pili ana i ke Aupuni, Ak. 20°
No. 424 pautu e pili ana i ke Aupuni; Ak. 85° No. 820 pautu e pili ana i ke Pihik i ke Pihik ma 1/10 Oka

20 April, 1852

A. F. Turner
Luna ana aine

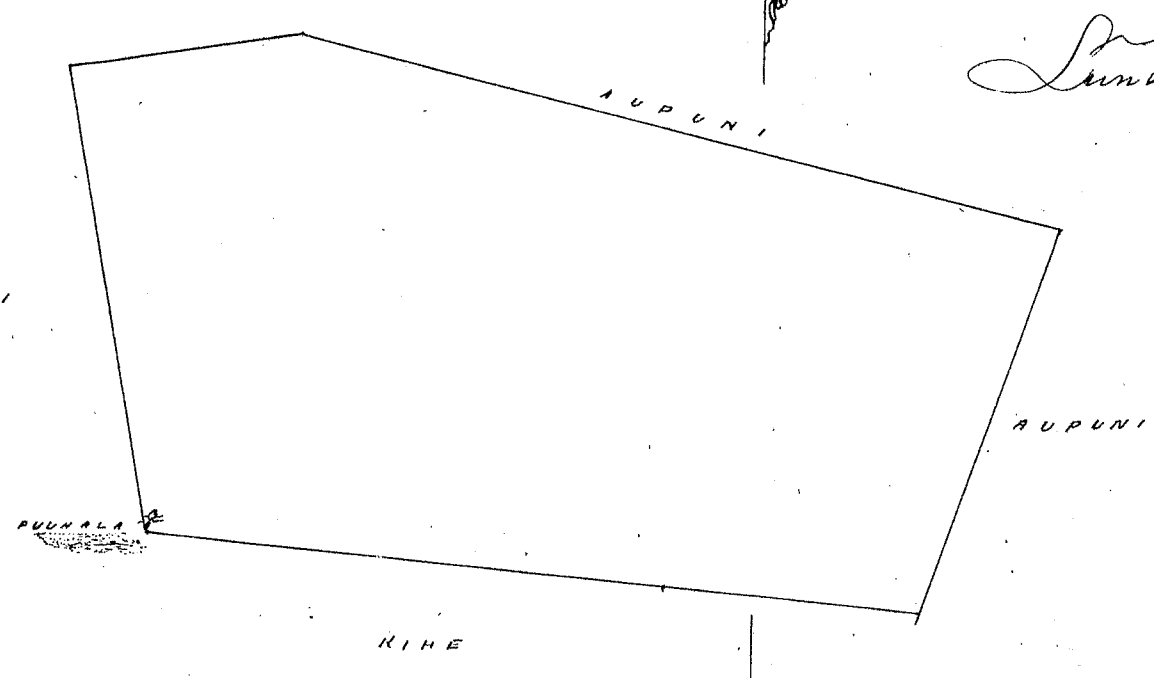

Wm Pau Loa #6
W. L. Lee
G. M. Robertson
C. Kikaula
J. H. Smith

Honolulu 1 Sep 1852

Kolu 5127 B. Pihonui

Waiamoa Kipahulu Maui

Ili o Aaukaka, Waiamoa Kipahulu Maui.
E hoomaka ana ma ke Pihik Akau, a e holo ana, Ak. 153° No. 93 pautu e pili ana i ke Kepaa, Ak. 27°
No. 153 pautu e pili ana i ke Kepaa, Ak. 56° No. 480 pautu e pili ana i ke Aupuni, Ak. 81° No. 96 pautu
e pili ana i ke Aupuni; Ak. 28° No. 748 pautu e pili ana i ke Koli; Ak. 49° No. 406 pautu e pili ana
i ke Aupuni; i ke Pihik ma 1/10 Oka

18, March, 1852

A. F. Turner
Luna ana aine

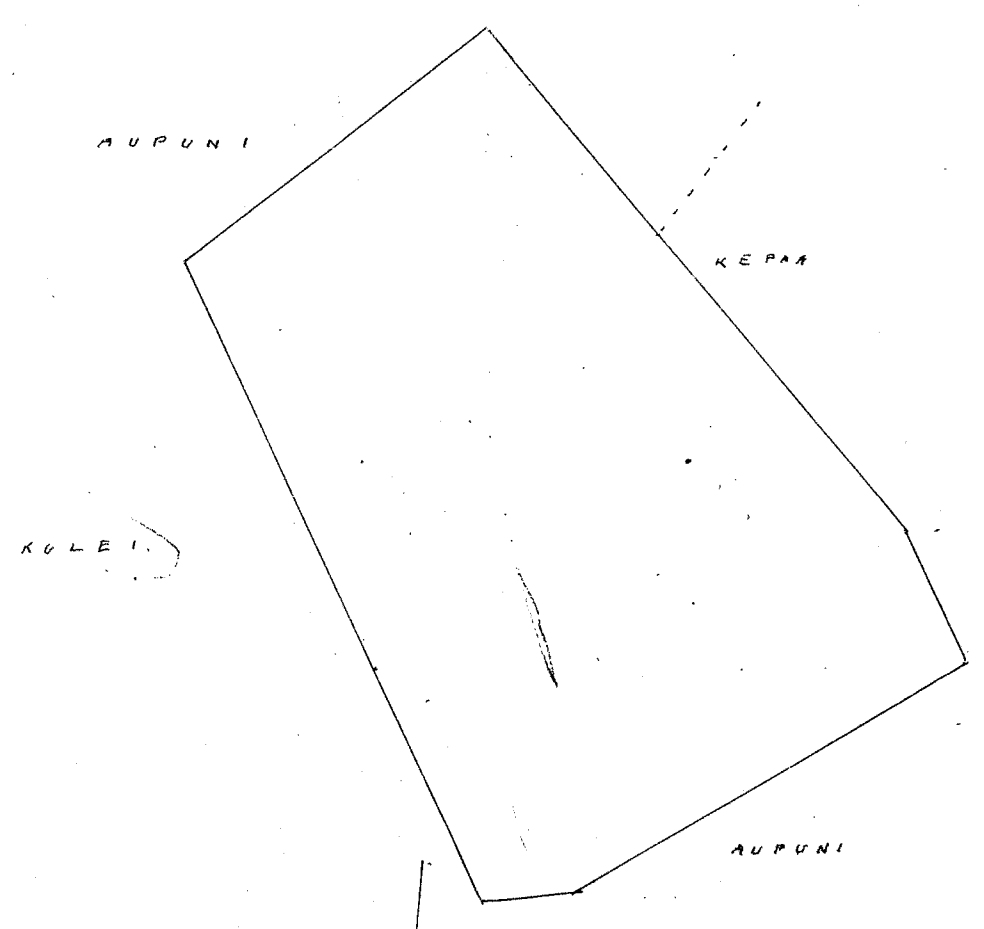

Uku Pau Loa #6
W. L. Lee
G. M. Robertson
J. Kekaulahao
J. H. Smith

Honolulu 1 Sep 1852

Hulu 3324:3648 Koala + 75216 Haiku Hawaii

Aina Kala me Kula maloko o Ke ili o Wailua Ahupuaa Haiku Puna Hawaii
Penei na Mokuna E hoomaka ana ma ke Piki, Ak, 0 ma Loi o Naniho alaila aku, Num. 25°
Hi, 87 1/100 Kaula e pili ana i na Loi o Naniho, Ak, 66 Hi, 1 50/100 Kaula e pili ana i ke Kahawai o
Aukia Ak, 26° Hi, 9 20/100 Kaula e pili ana i na Loi o Kaula, Num 53° Hi, 1 50/100 Kaula e pili ana
i Kahi Auwai e ili ana i Eka 1 Kula,

Hawaii, Aug 10, 1852
W. H. Pease

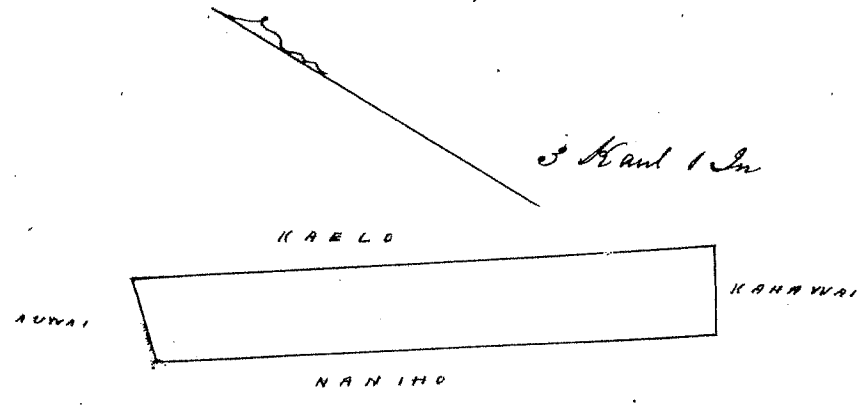

75216
Dec 7 1852

Uku Pau Loa #5
W. L. Lee
G. M. Robertson
J. Kekaulahao
J. H. Smith

Honolulu 6 Sep 1852

Hulu 3403^B Hoaupuu Haiku Hawaii

Maloko o Ke Ahupuaa o Haiku Puna Hawaii
Penei na Mokuna, E hoomaka ana ma ke Kahawai o Haiku ma ke Kahawai o Liipupu
ma ke Mamui, Num 35° Hi, 5 Kaul e pili ana i ke Kahawai o Haiku Ak, 55° Hi, 10 40/100
Kaul e pili ana i ke Kula o Konoehiki Ak, 104° Hi, 5 40/100 Kaul e pili ana i ke Kula o Kono-
hiki Num. 65° Hi, 12 Kaul e pili ana i ke Kahawai o Liipupu Num. 24° Hi, 1 50/100 Kaul,
e pili ana i ke Kahawai o Liipupu e ili ana, 7 Eka, 50 Perka,

Hawaii, Aug. 10, 1852

W. H. Pease

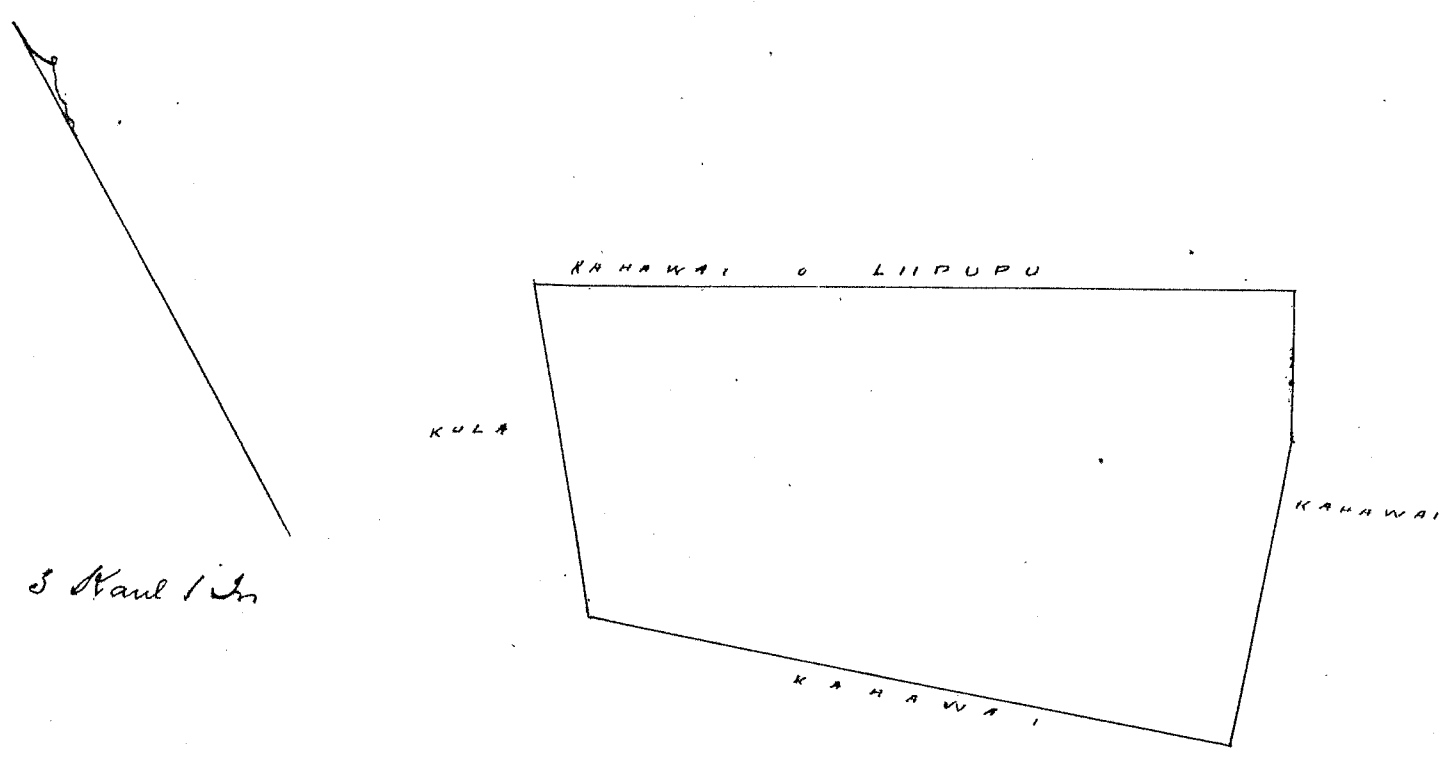

Uku Pau Loa #8

W. L. Lee

J. H. Smith
G. M. Robertson

Honolulu 6 Sept 1852

Helu 10906 Umiumi

Kealia Keawai

Maluku. Kealia Ahupuaa Puna Hawaii.

1 Pahale, peni ova mokuna. Chromatika ana ova ke Kahawai o Kealia ma ke Kapa Aka ma Kahi pahu luan, alaila Aka. 5° No 1. 20/100 Kaul e pili ana i ke Kula. Konohiki. Hem. 80° No. 2. 80/100, Kaul e pili ana i ke Kula. Konohiki. Hem. 56° No. 90/100 Kaul. e pili ana i ke Kahawai. Kealia Aka 80° No. 150/100 Kaul e pili ana i ke Kahawai. Kealia e ili ana i Kula,

2, Nawa Kalo me Kula Chromatika ana ma ke Kahawai Kili Hema Kom. i na Lii o Kaawa pupuole, alaila aku, Aka. 35° No. 3 Kaul. e pili ana ina Lii. Kaawapupuole, Aka. 62° No 3 20/100 Kaul e pili ana i ke Kula. Konohiki. Hem 35° No 3 20/100 Kaul. e pili ana ina Lii. Konohiki No 65° No 3 60/100 Kaul e pili ana i ke Kahawai. Eili ana i Eka 15 Perka

Hawaii, Aug 10, 1852

W. H. Pease

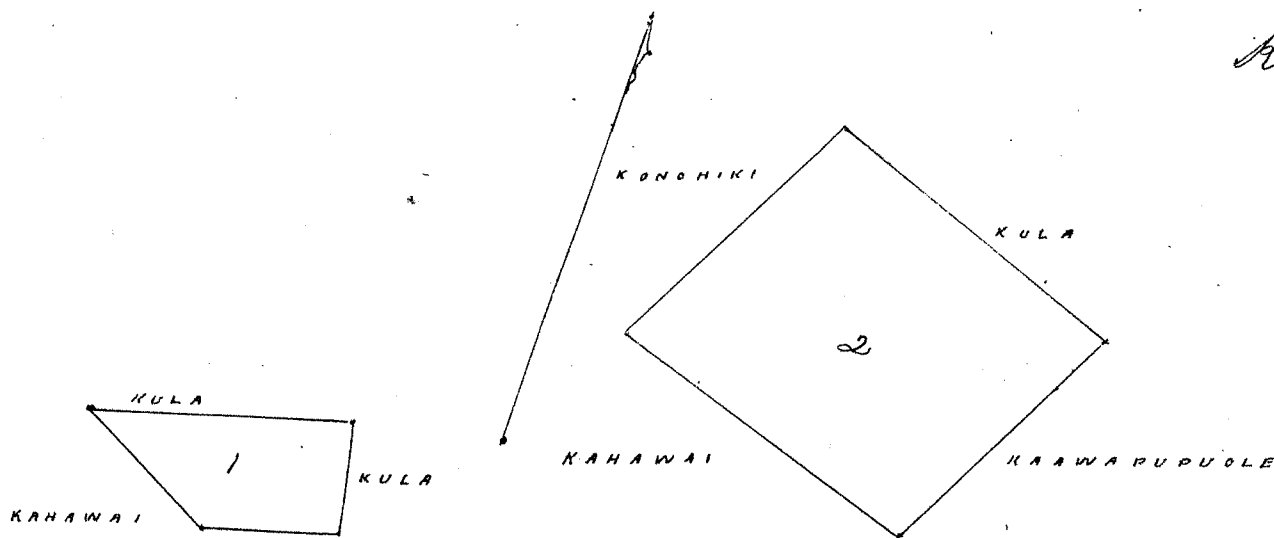

2 Kaul 1 In

Uku Pau Loa # 6

W. H. Pease
G. M. Robertson
J. Kekaulahe
J. H. Smith

Honolulu 6 Sep 1852

Helu 8842 Kaawapupuole

Kealia Puna Hawaii

Maluku. Ke Ahupuaa. Kealia, Puna, Hawaii.

Apana 1. Lima Lii me Kula maluku i Kahi o Makapuu. Peni ova Mokuna, Chromatika ana ma ke Kahawai o Kealia ma ke Kapa Nihina ova Kahi Han. Aka. 32° No. 2. 20/100 Kaul e pili ana ina Lii. Konohiki. Aka. 40° No 2 50/100 Kaul e pili ana i ke Kula Konohiki. Hem 35° No 3 Kaul e pili ana ina Lii o Umiumi. Hem. 58° No. 2 55/100 Kaul. e pili ana i ke Kahawai, e ili ana 2, Puda, 20, Perka,

Apana 2. Pahale maluku. Kahi o, Hauaha. Peni ova Mokuna. Chromatika ana ma ke Kahawai ma ke Kapa Hema ova Kahi pahu Aka. 80° No. 1 Kaul. e pili ana ina Lii o Umiumi. Aka. 20° No. 2 Kaul. e pili ana i ke Kula. Konohiki. Hem. 80° No. 3 20/100 Kaul e pili ana i ke Kula. Konohiki. Hem. 60° No. 3 20/100 Kaul e pili ana i ke Kahawai. Eili ana i Puda 25 Perka

Hawaii Aug 10, 1852

W. H. Pease

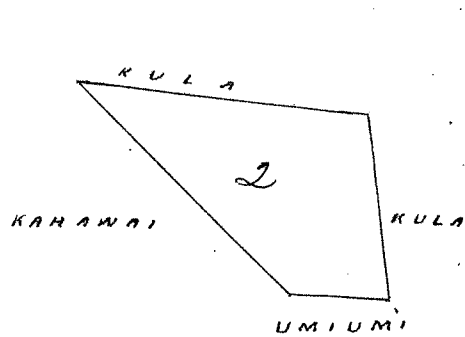
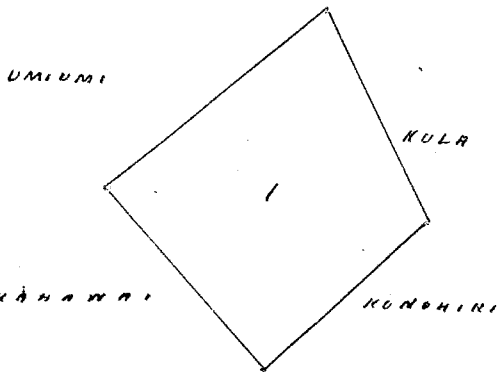

2 Kaul 1 In

154

Wm Pau Loa # 5
W. H. C.
G. M. Robertson
J. Kekaulahao
J. H. Smith

Honolulu 6 Sep 1852

Heleu 10628 Luki

Kealia Puna Kawai

Maloko o ke Ahupuaa o Kealia Puna Kawai

Apawa 1. Pahale maloko o ka ili o Kaunakakai, Penei ova mokuna, E hoomaka ana owa ka Auwai, owa kahi paku laau, Ak 20° No 2, 60/100 Kaul e pili ana i ke kula o Konohiki Hem. 52° No 3 20/100 Kaul e pili ana i Kalokolua, Hem. 45° No 1 60/100 Kaul e pili ana i Kalokolua, Ak 48° No 2 Kaul e pili ana i ka auwai, e ili ana 2 Puda.

Apawa 2. E hoomaka ana owa kahi Loi o Konohiki owa ka paku laau alaila aku Hem. 25° No 3 40/100 Kaul e pili ana iwa Loi o Konohiki Ak 65° No 1 60/100 Kaul e pili ana iwa Loi o Konohiki Ak 25° No 3 40/100 Kaul e pili ana iwa Loi o Konohiki Hem 65° No 1 60/100 Kaul e pili ana iwa Loi o Konohiki E ili ana 2 Puda. } Perka,

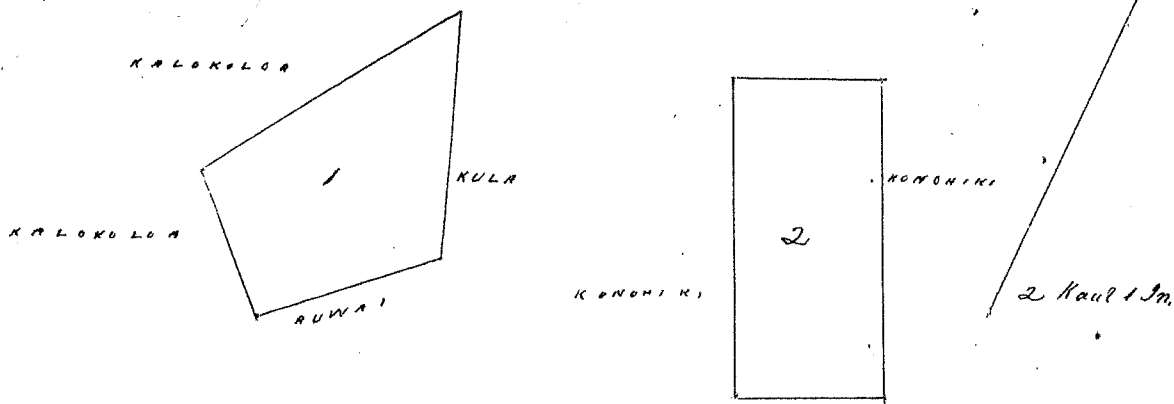

Kawai Aug 10 1852

W. H. C.

Wm Pau Loa # 5
W. H. C.
G. M. Robertson
J. Kekaulahao
J. H. Smith

Honolulu 6 Sep 1852

Heleu 8833 Kiaipa

Kealia Puna Kawai

Maloko o ke Ahupuaa o Kealia Puna Kawai

Apawa 1. Akahi Loi maloko o ka ili o Nulihale, Penei ova mokuna E hoomaka ana owa ka kula owa kahi Loi o Konohiki alaila aku, Ak. 85° No. 1. 30/100 Kaul e pili ana iwa Loi o Konohiki Hem 80° No 1 Kaul e pili ana iwa Loi o Konohiki Hem 85° No 1 30/100 Kaul e pili ana iwa Loi o Kahala, Ak. 10° No 1. Kaul, e pili ana i ke kula o Konohiki e ili ana } Perka

Apawa 2. E hua Loi maloko o ka ili o Nulihale, Penei ova mokuna, E hoomaka ana owa kahi Kala owa ka pati, Hem 30° No 1 50/100 Kaul, e pili ana iwa Loi o Konohiki Ak 56° No 1. 20/100. Kaul e pili ana iwa Loi o Konohiki Ak. 35° No. 1. 20/100 Kaul, e pili ana i ke kula o Konohiki Hem. 60° No 1. 20/100 Kaul, e pili ana i ke kula o Konohiki, E ili ana 2 Puda } Perka

Apawa 3. Pahale maloko o ka ili o Waipunaula, Penei ova mokuna, E hoomaka ana owa ka Kapa Kema o Waipunaula, owa kahi paku laau, Hem. 5° No 2. Kaul e pili ana i ke kula o Konohiki, Ak 69° No. 1. 50/100 Kaul e pili ana i ke kula o Konohiki, Ak 86° No 1 45/100 Kaul e pili ana i Waipunaula, e ili ana 1 Puda. } Perka,

Kawai Aug. 10, 1852

W. H. C.

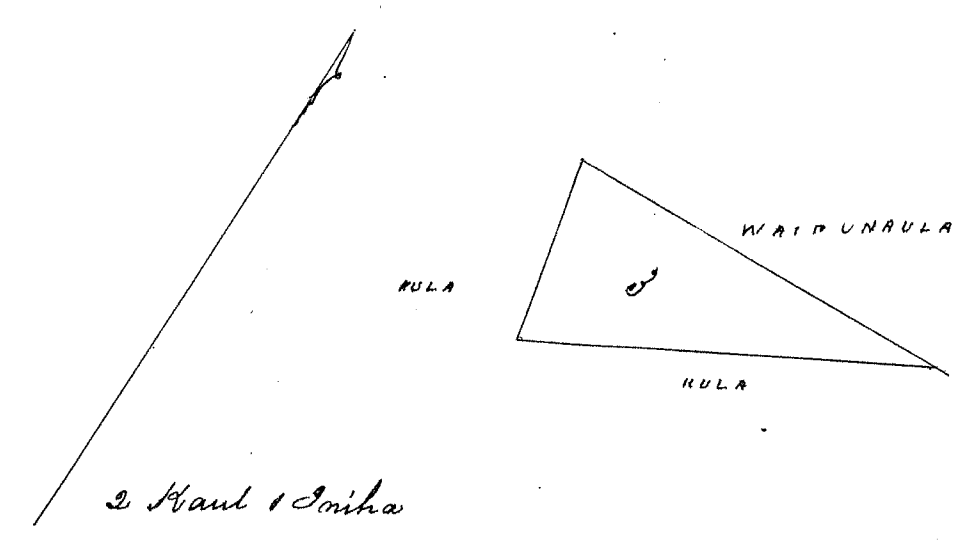
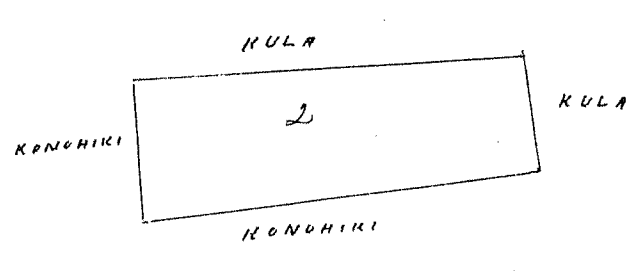
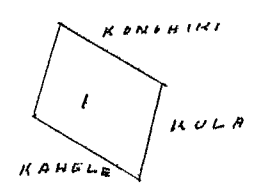

Uku Pau Loa 5
 W. H. H.
 J. M. Robertson
 J. Kekaulahas
 J. H. Smith

Honolulu 6 Sep 1852

Kolle 10907 Naumiumi

Kealia Puna Kawai

Maloko o ke Ahupurua o Kealia, Puna Kawai

Apana 1. Elua Loi maloko o ka ili o Hanaipehu, Penei oia Motuana, E hoomaka ana ma ke kiki
 Ke. Ke. o Kahi Loi o Konohiki, "Kanielo", ka inua, Hem. 75° Ke. 2 2/100 Kaul e pili ana i ka Loi "Kanielo",
 Ke. 30° Ke. 4 Kaul e pili ana ina Loi o Konohiki, Ak. 85° Ke. 1 Kaul e pili ana ina Loi o Konohiki, Ak. 70°
 Ke. 3 7/100 Kaul e pili ana ina Loi o Konohiki, Ak. 5° Ke. 2 7/100 Kaul, e pili ana i ke Kula o Konohiki,
 E ili ana 1, Eka.

Apana 2. Pahale ma Kula, maloko o ka ili o Ahiama, Penei oia Motuana, E hoomaka ana
 ina ka pali, ma Kahi pohaku, abaita aku, Hem. 30° Ke. 3 Kaul, e pili ana i ka pali, Ak. 70° Ke. 1 1/100 Kaul
 e pili ana i ka pali, Ak. 43° Ke. 2 Kaul, e pili ana i ke Kula o Konohiki, Ak. 20° Ke. 2 3/100 Kaul e pili ana
 i ke Kula o Konohiki, Hem. 72° Ke. 3 1/100 Kaul e pili ana i ke Kula o Konohiki, E ili ana 3 Puda 4 Perka

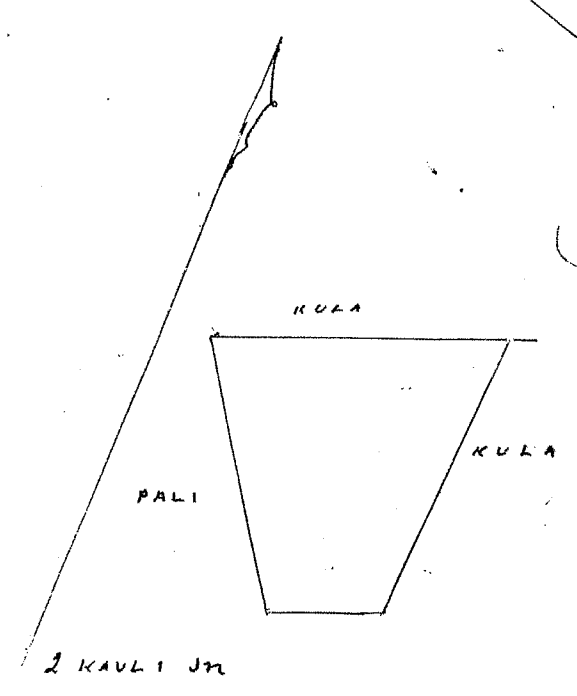
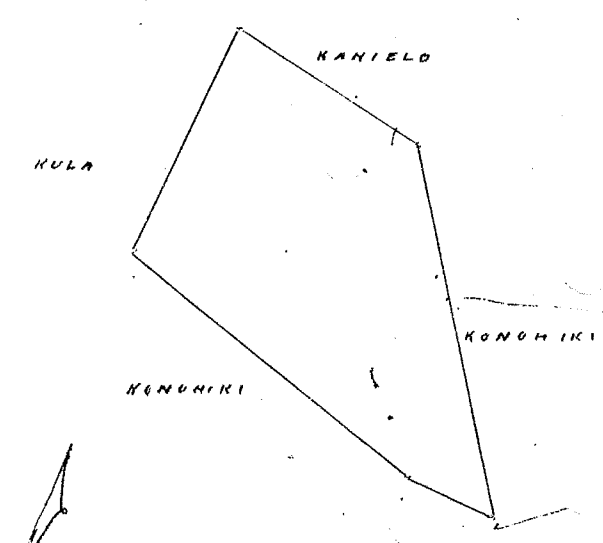

Kawai, Aug. 10, 1852

W. H. Pease

Uku Pau Loa #6
W. H. H.
G. M. Robertson
J. Kikaulahao
J. H. Smith

Honolulu 6 Sep 1852

Hoelu 10473 Nahi (611) Kealia Puna Hawaii

Ap. 1 Aina Kalo Pahale one Kula. maloko. ka ili. kaahaki. Puna Hawaii, Ahupuaa o Kealia Puni ma Mokuna, E hoomaka ana ma Kahi pohaku ma Kapa Akau. ke Kahawai o Kealia, alaila, Ak. 55° Ni. 1 Kaul e pili ana i ke Kula. Konohiki Ak. 20° Ni. 3 20/100 Kaul e pili ana i ke Kula. Konohiki Ak. 67° Ni. 6 10/100 Kaul e pili ana i ke Kula. Konohiki Ak. 55° Ni. 2 20/100 Kaul e pili ana i ke Kula. Konohiki Ak. 33° Ni. 7 55/100 Kaul e pili ana i ke Kahawai. Kealia, Eili ana. 2 Eka, 30 Perka.

Hawaii Aug 10, 1852

W. H. Pease

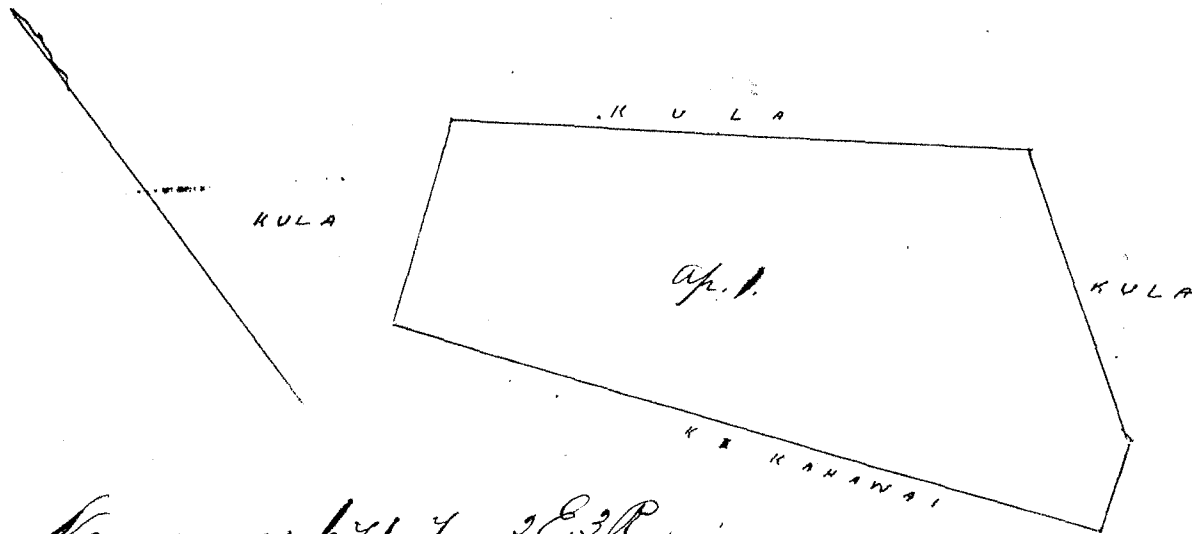

Nana wao 671.7 2E.3R.
2 0.30
4E 3.30

Uku Pau Loa #4.00
W. H. H.
G. M. Robertson
J. Kikaulahao
J. H. Smith

Honolulu 1 Sep 1852

Hoelu 8834 Kealawaia Kealia Puna Hawaii

Maloko. ke Ahupuaa o Kealia, Puna, Hawaii.

Apawa 1. Pahale ma ka ili. Lapanui Puni ma Mokuna, E hoomaka ana ma Kahi Akau, ma ke Kula. Konohiki Ak. 75° Ni. 2 50/100 Kaul e pili ana i ke Kula. Konohiki Ak. 51° Ni. 2 Kaul e pili ana i ke Kula. Konohiki Ak. 75° Ni. 2 50/100 Kaul e pili ana i ke Kula. Konohiki Ak. 51° Ni. 2 Kaul e pili ana i ke Kula. Konohiki Eili ana 1 Ruda 36 Perka.

Apawa 2, Aina Kalo one Kula maloko. ka ili. Kahue, E hoomaka ana ma ke Kahi Ni. Ni. ka Li. Konohiki Hamaluhukui ka inoa alaila aku. Ak. 88° Ni. 3 Kaul e pili ana ma Li. Konohiki Ak. 2° Ni. 3 50/100 Kaul e pili ana i ke Kula. Konohiki Ak. 78° Ni. 3 Kaul e pili ana i ke Kula. Konohiki Ak. 1° Ni. 2 70/100 Kaul e pili ana i ke Kula. Konohiki, Eili ana 3 Ruda 20, Perka

Hawaii, Aug 10, 1852

W. H. Pease

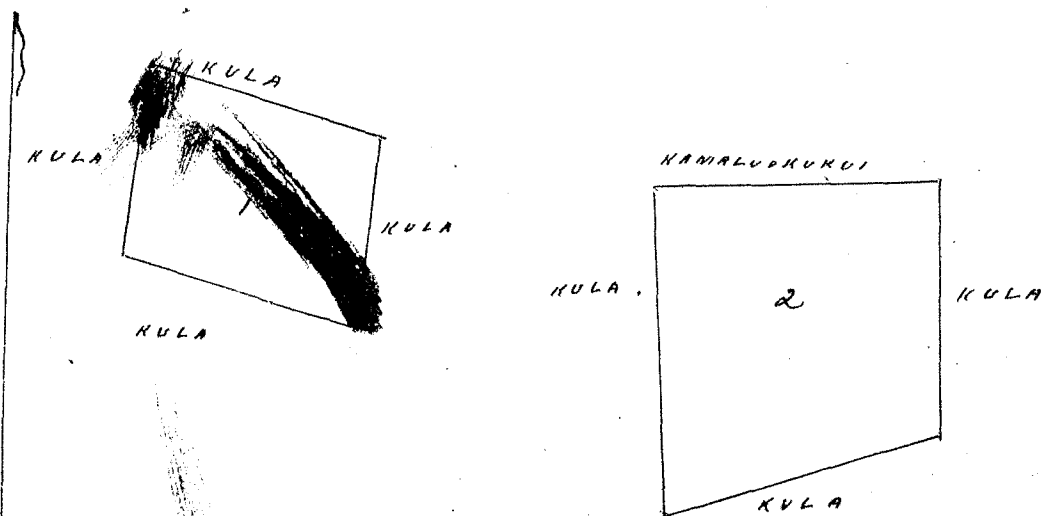

R	P
1	36
3	20
2	57
1-1	16
2-2	70

Uku Pau Loa # 5

W. H. P. H.
G. M. Robertson
J. Kekaulahao
J. H. Smith

Honolulu 6 Sep 1852

Heleu 8060 Heulialo

Kealia Puna Hawaii

Maloko o ke Ahupuaa o Kealia, Puna, Hawaii.

Apana 1. Pahale Maloko o ka ili o Kaula, Penei na Motuua, E hoomaka ana ma ke Kula o Konohiki, ma kahi pahu laau, Hem. 20° Kom. 1.7⁰/₁₀₀. Kaul, e pili ana i ke Kula o Konohiki, Hem. 75° Hi. 2. Kaul e pili ana i ke Kula o Konohiki, Ak. 20° Hi. 1.7⁰/₁₀₀ Kaul, e pili ana i ke Kula o Konohiki, Ak. 75° No. 2 Kaul, e pili ana i ke Kula o Konohiki, E ili ana i Ruda, Ii, Perka.

Apana 2. E kolu Loi maloko o ka ili o Kealohipaa, Penei na Motuua, E hoomaka ana ma ke Pihii He, No, o ke Konohiki Loi "Kealohipaa" alaila aku. Ak. 89° Hiki. 5. Kaul e pili ana ina Loi. Konohiki Hem. 5° No. 2. Kaul e pili ana i ke Kula o Konohiki Hem. 89° Kom. 5 Kaul, e pili ana i ka Loi "Kaliolua" Ak. 5. Hiki. 2. Kaul e pili ana i ke Kula o Konohiki, E hoomaka ana i ka.

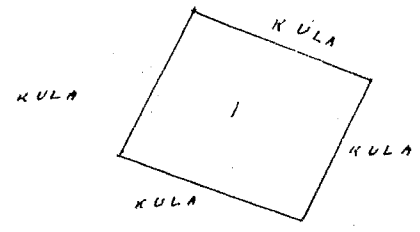

Hawaii Aug 10 1852
M. H. Pease

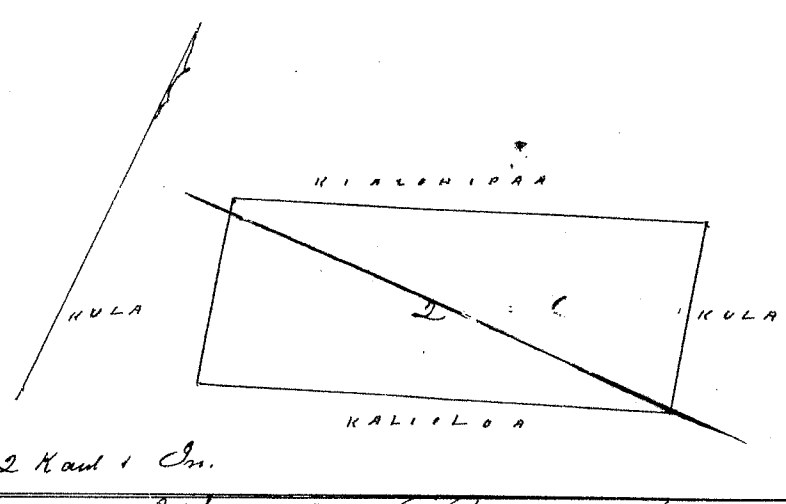

Apana 2 awarded to
U. H. Patten Malohine
No 10129

Uku Pau Loa # 5

W. H. P. H.
G. M. Robertson
J. Kekaulahao
J. H. Smith

Honolulu 6 Sep 1852

Heleu 10148 Moamaki

Kealia Puna Hawaii

Maloko o ke Ahupuaa o Kealia, Puna, Hawaii.

Apana 1. Pahale maloko o ka ili o Lapanui, Penei na Motuua, E hoomaka ana ma ke Kula o Konohiki, ma kahi pa o Wihwili alaila aku, Ak. 37° No. 2. Kaul e pili ana i ke Kula ome Pa, Hem. 53° No. 2 Kaul, e pili ana i ke Kula ome Pa, Hem. 37° Hi. 2 Kaul, e pili ana i ke Kula ome pa, Ak. 53° Hiki. 2 Kaul, e pili ana i ke Kula ome pa, e ili ana, i Ruda, Ii, Perka.

Apana 2. Aina Kalo Maloko o ka ili o Lapanui, Penei na Motuua, E hoomaka ana ma ke Kula o Konohiki ma ke Pihii A. Hi. o ma Loi, o Kauohi, alaila, Ak. 50° No. 4 Kaul e pili ana ina Loi o Kauohi, Ak. 29° Hi. 3. Kaul e pili ana i ke Kula o Konohiki Hem. 48° Hi. 1.7⁰/₁₀₀ Kaul, e pili ana i ka Loi o "Hulumoa", Hem. 52° No. 2. 1⁰/₁₀₀ Kaul, e pili ana i ke Kula o Konohiki e ili ana i ka 20 Perka.

Hawaii Aug 10 1852

M. H. Pease

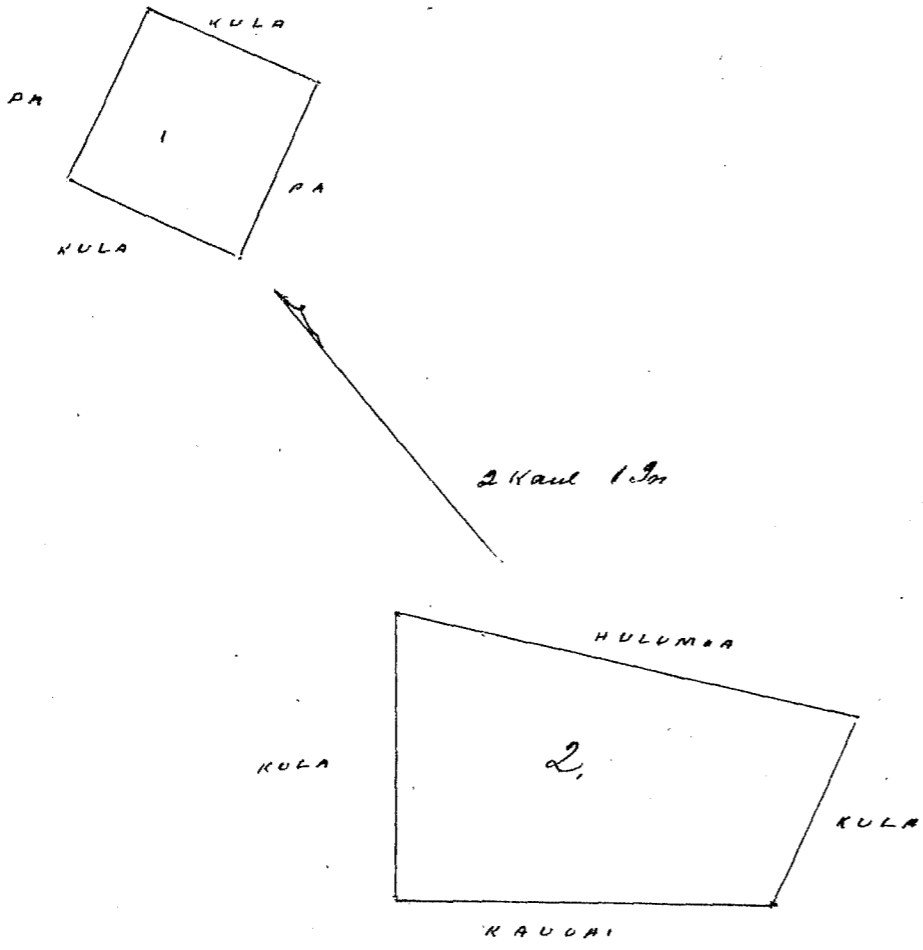

Wm Pau Loa
 Wm
 G. M. Robertson
 J. Kekaulahas
 J. H. Smith

Honolulu 6 Sep 1852

Heleu 1989 Tuali

Kealia Puna Hawaii

Maloko o ke Ahupuaa o Kealia Puna Hawaii

Apuna 1. Pahae maloko o ka ili o Kaula Puni ma Mokuwa. E hoomaka ana ma Kahi Aau, ma ke Kapa Aau o ke Kahawai o Kealia, alaila aku, $AK. 25^{\circ}$ No 2 Haul, e pili ana i ke Kula o Kono- hiki, $AK. 70^{\circ}$ No. $1.50/100$ Haul e pili ana i ke Kula o Kono hiki, $AK. 25^{\circ}$ No. 2, Haul, e pili ana i ke Kula o Kono hiki, $AK. 70^{\circ}$ No. $1.50/100$ Haul e pili ana i ke Kahawai o Kealia e ili ana i Puna, } Perka,

Apuna 2. Aina Kala me Kula, maloko o ka ili o Kaula, Puni ma Mokuwa, E hoomaka ana ma ke Kahawai, ma ke Kapa Aau, ma ke Kahi Ke. Ke. o ma Loi o Kono hiki, alaila aku $AK. 18^{\circ}$ No. $2/100$ Haul, e pili ana ma Loi o Kono hiki, $AK. 78^{\circ}$ No. 2 Haul e pili ana i ke Kula me auwai, $AK. 70^{\circ}$ No. 5 Haul e pili ana i ke Kula me auwai, $AK. 18^{\circ}$ No. 2 Haul e pili ana i ke Kula me auwai, $AK. 66^{\circ}$ No. 7 Haul e pili ana i ke Kahawai, e ili ana i Puna, } Perka,

Hawaii Aug 10, 1852

W. A. Pease

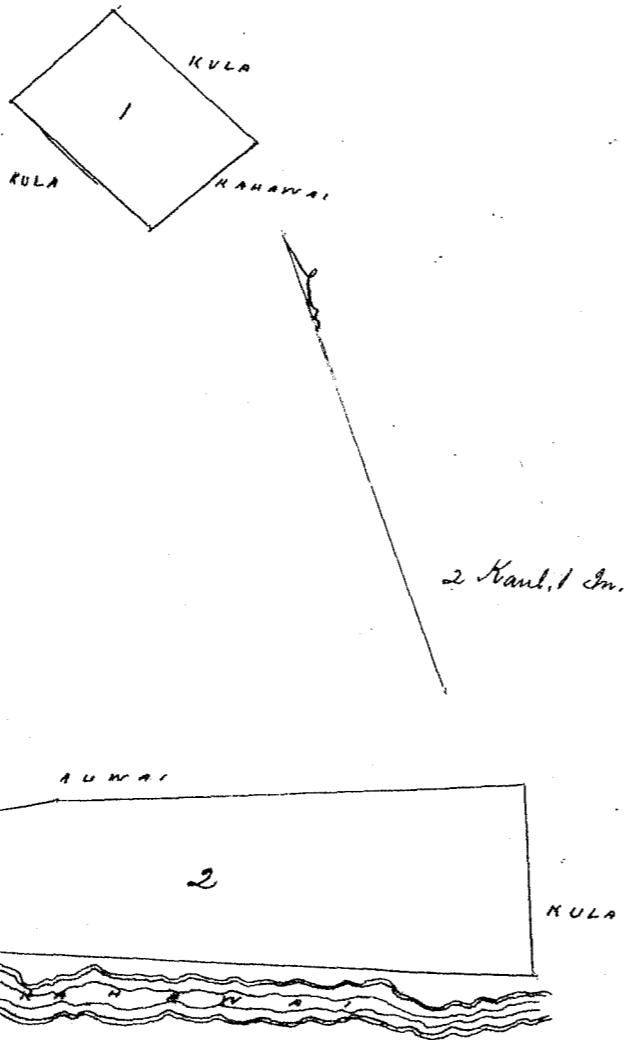

Wm Pau Loa # 6
W. H. Ke
G. M. Robertson
J. Kekaulahas
J. H. Smith

Honolulu 6 Sep 1852

Hulu 8061 Kaimau

Kealia Puna Hawaii

Aina Kalo. Pahale ma Kula, maloko. ka ili. Kapuna, Ahupuaa Kealia Puna Hawaii,
Penei ma Mokuna, E hoomaka ma ke Kahawai o Kealia, ma ke Kapa Aka, ma Kahi paku laau,
Ak. 25° Hi. 4. 50/100 Kaul e pili ana i ke Kula o Konohiki, Ak. 67° Hi. 5 Kaul. e pili ana i ke Kula o
Konohiki, Hem. 50° Hi. 1. 80/100 Kaul e pili ana i ke Kula o Konohiki Hem. 20° Hi. 4. 20/100 Kaul. e pili ana
i ke Kula o Konohiki Hem. 82° Hi. 5. 60/100 Kaul. e pili ana i ke Kahawai o Kealia e ili ana i Eka
3. Puda. 25 Perka

Hawaii Aug 10 1852

W. H. Pease
3

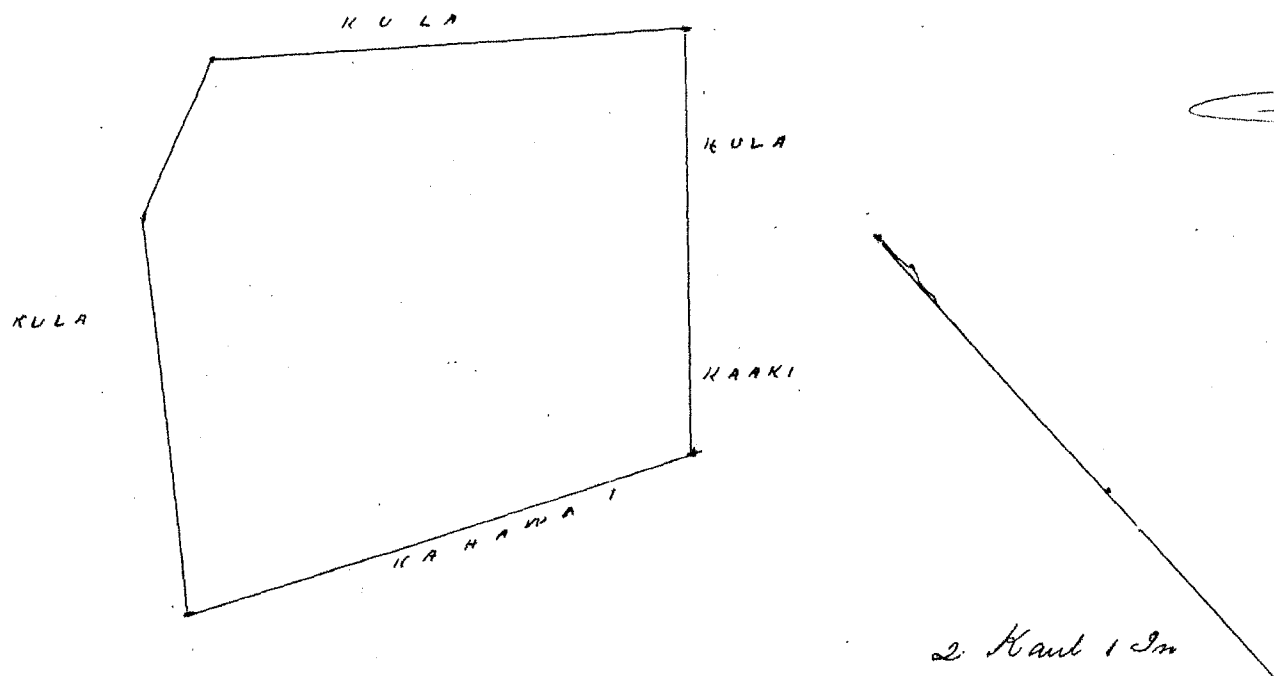

Wm Pau Loa # 6
W. H. Ke
G. M. Robertson
J. Kekaulahas
J. H. Smith

Honolulu 6 Sep 1852

Hulu 7966 Keaonui

Kealia Puna Hawaii

E Kolu Loi maloko. ka ili. Mahuaku. Ahupuaa, Kealia, Puna, Hawaii,
Penei ma Mokuna, E hoomaka ana ma ke Kahi Ke, Ke. o ma Loi, o Kalawaia, abaila aku, Hem. 78°
Hi. 3. 50/100 Kaul e pili ana ina Loi. Kalawaia, Hem. 12° Hi. 3. 20/100 Kaul e pili ana i ke Kula o Konohiki.
Ak. 78° Hi. 3. 50/100 Kaul e pili ana i ke Kula o Konohiki, Ak. 12° Hi. 3. 20/100 Kaul e pili ana i ke aawai o
Kahui e ili ana i Eka 20, Perka

Hawaii Aug 10, 1852

W. H. Pease
3

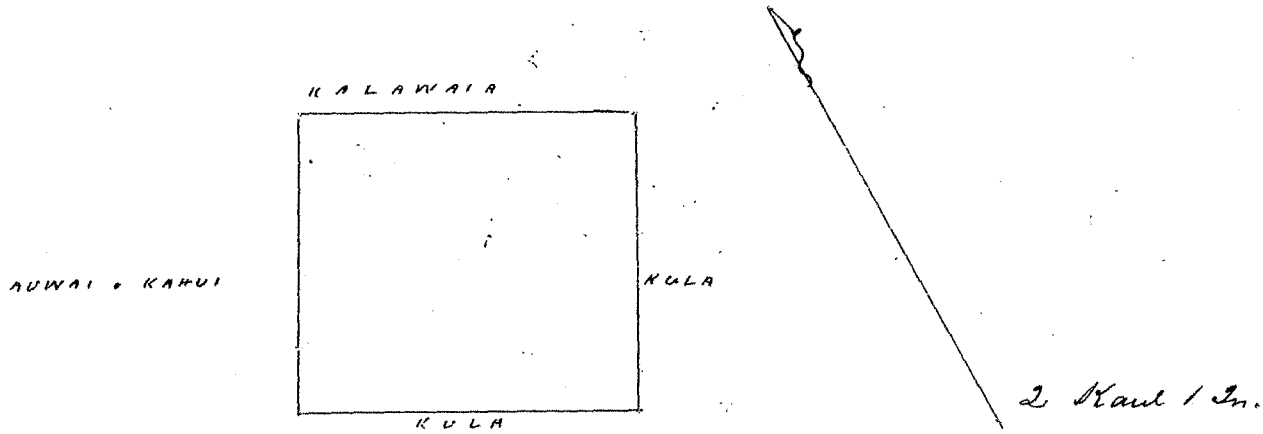

Wm Pau Loa # 5.
W. H. Ke
G. M. Robertson
J. Kekaulahas
J. H. Smith

Honolulu 6 Sep 1852.

Patent issued June 9th 1877

Heleu 10149 Moakiahine

Kealia Tuna Kawai

Aina Kalo me Kula, maloko. ka ili. Kealohipaa, Ahupuaa. Kealia, Tuna, Kawai,
Penei me Motuua, E hoomaka ana ma ke Kula o Konohiki, ma kahi pahu laau, alaila aku
Ak. 89° Ki. 5 Kaul. e pili ana ina Loi. Konohiki hem. 5° Ko. 2 Kaul. e pili ana i ke Kula o Konohiki
hem. 89° Ko. 5 Kaul. e pili ana i ka Loi. Kahioloa, Ak. 5° Ki. 2 Kaul. e pili ana i ke Kula
o Konohiki E ili ana 1 Eka.

Kawai Aug 10, 1852

W. H. Pease
3

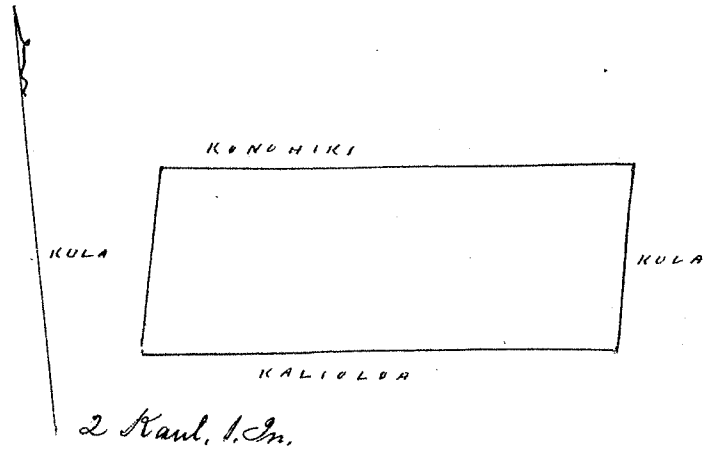

Wku Pau Loa #5

W. H. Pease
G. M. Robertson
J. Kekaulahas
J. H. Smith

Honolulu 6 Sep 1852

Heleu 3413 B Moaki

Kealia Tuna Kawai

Aina Kalo, Kula me Tahale, maloko. ka ili. Kapunakai, Ahupuaa. Kealia Koolan
Kawai. Penei me Motuua, E hoomaka ana ma ke Kahawai o Kealia ma ke Kapa Akau
ma kahi pohaku. Ak. 65° Ko 5 Kaul. e pili ana i ke Kula o Konohiki; Ak. 25° Ki. 3 1/100 Kaul.
e pili ana ina Loi o Kaniiau, hem. 70° Ki. 1. 20/100 Kaul. e pili ana i ke Kula o Konohiki
Ak. 12° Ki. 2 Kaul. e pili ana i ke Kula o Konohiki; hem. 70° Ki. 75/100 Kaul. e pili ana
i ke Kula o Konohiki; hem. 25° Ko. 2. 50/100 Kaul. e pili ana i ke Kula o Konohiki; hem. 60°
Ko. 4. 20/100 Kaul. e pili ana i ke Kahawai o Kealia. e ili ana 3 Eka, 2, Paha, 0, Puka

Kawai Aug 10, 1852

W. H. Pease
3

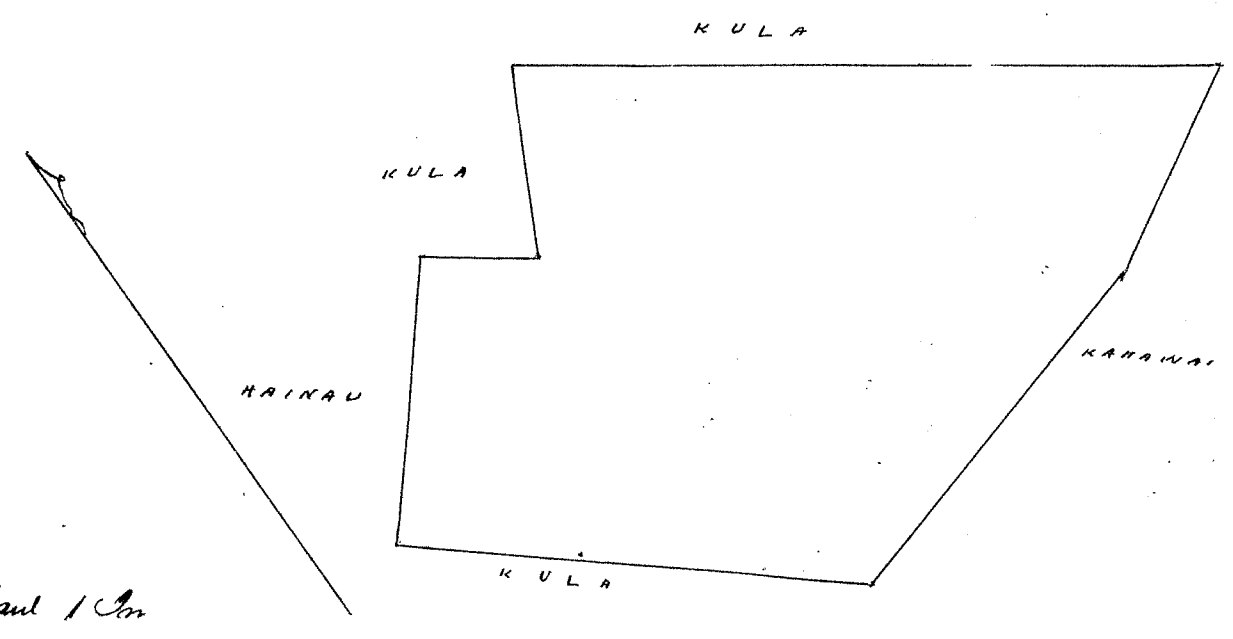

Wku Pau Loa #6

W. H. Pease
G. M. Robertson
J. Kekaulahas
J. H. Smith

Honolulu, 6. Sep. 1852.

Aina Kalo me Kula, Pahale, Maloko o kahi o Kapuakohala, Ahupuaa Honaiikawaa Puna Kawai Penei ma Mokuna, E hoomaka ana ma ke Kahawai, ma ke Kapa Akau, ma Kahi pohaku, alaila, Hem. 5° Ho. 7,50/100 Kaul. e pili ana i ke Kula o Konohiki Hem. 83° Ho. 3,40/100 Kaul. e pili ana i ke Kula o Konohiki; Ak. 7° Ho. 4,65/100 Kaul. e pili ana i ke Kula o Konohiki; Ak. 13° Ho. 7,10/100 Kaul. e pili ana i ke Kula o Konohiki; Ak. 87° Ho. 4 Kaul. e pili ana i ke Kula o Konohiki; e ili ana, 5 Eka, 3 Perka.

Hawaii, Aug. 10, 1852

W. H. Pease

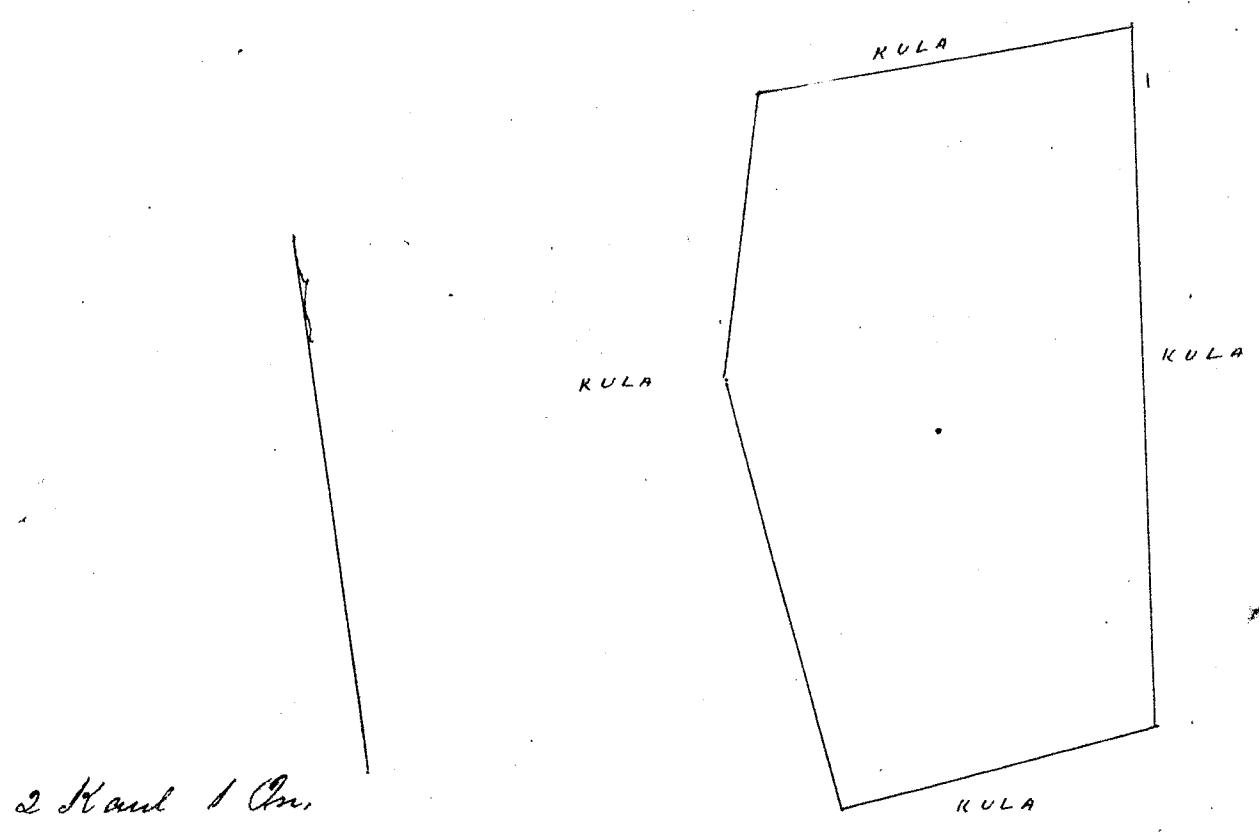

Wm Pau Low # 6
W. H. Pease
G. M. Robertson
J. Kekaulaheo
J. H. Smith

Honolulu 6 Sep. 1852

Aina Kalo, Kula me Pahale, Maloko o ke Ahupuaa o Kumukumu Puna, Kawai, Penei ma Mokuna, E hoomaka ana ma ke Kahawai o Kumukumu ma Kahi Akau ma Kapa Akau, Ak. 35° Ho. 3 Kaul. e pili ana i ke Kula o Konohiki; Ak. 55° Ho. 4,20/100 Kaul. e pili ana i ke Kula o Konohiki; Ak. 30° Ho. 4 Kaul. e pili ana i ke Kula o Konohiki; Ak. 55° Ho. 5,20/100 Kaul. e pili ana i ke Kula o Konohiki; Hem. 30° Ho. 3,50/100 Kaul. e pili ana i ke Kula o Konohiki; Ak. 55° Ho. 5 Kaul. e pili ana i ke Kula o Konohiki; Hem. 25° Ho. 3,50/100 Kaul. e pili ana i ke Kula o Konohiki; Hem. 55° Ho. 12 Kaul. e pili ana i ke Kula o Konohiki e ili ana 5 Eka, 30 Perka.

Hawaii, Aug 10, 1852

W. H. Pease

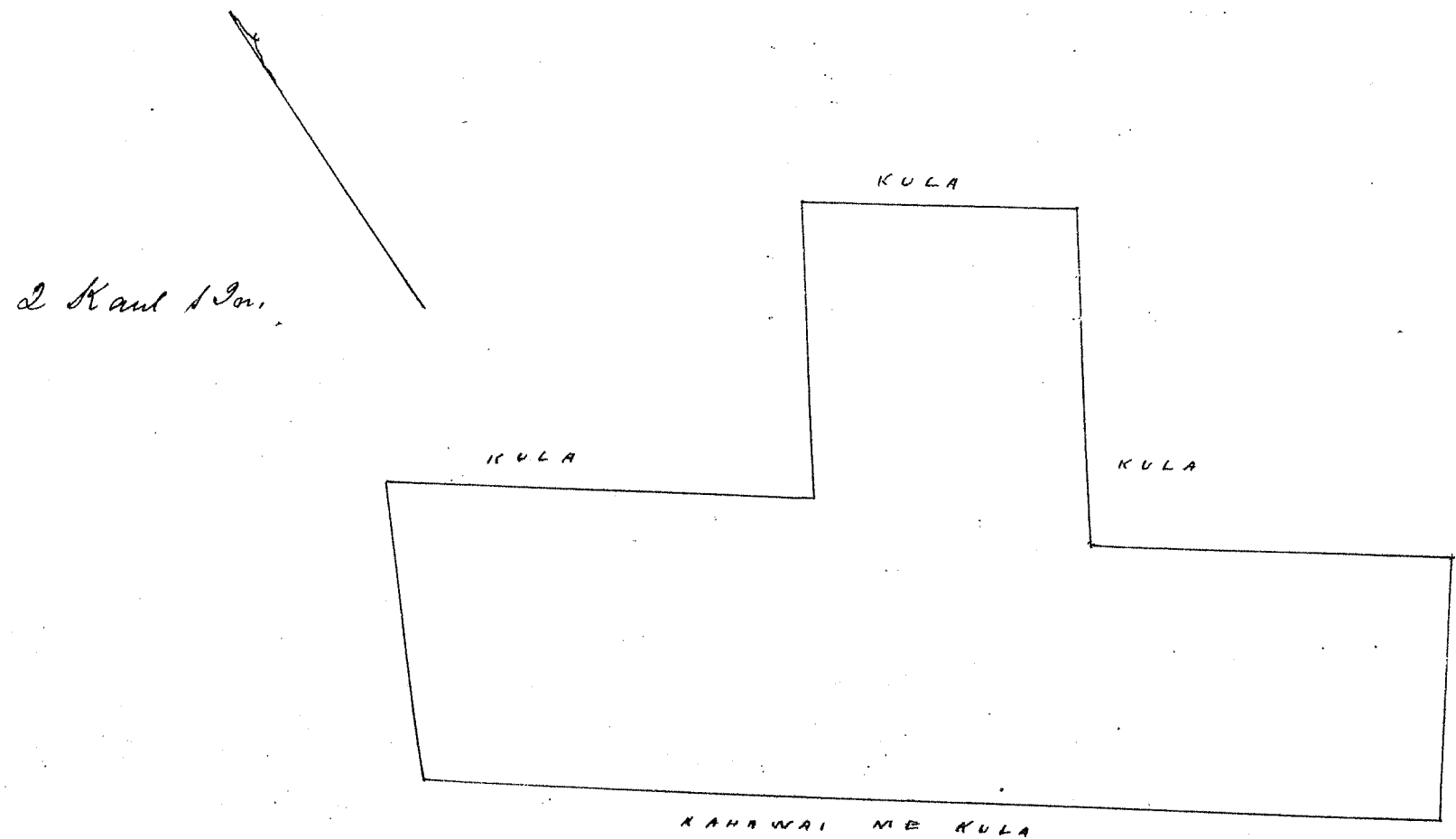

Uku Pau Loa # 7

W. L. Lee
G. M. Robertson
J. Kekaulahao
J. H. Smith

Honolulu 6 Sep 1852

Keleu 4909 Kealeu

Anehola Kauai

Matoko o ke Ahupuaa o Anehola Koolan Kauai.

Apuana 1. Pahale, onaloko o ka ili o Kamalupa, Penei ova onokuna. E hoomaka ana ma kaahi paha laau, owa ke Kahawai, Ak. 73° Ho. 125/100 Kaul, e pili ana i ke Kula o Konoiki, Kem 6° Ho. 3.50/100 Kaul, e pili ana ina Loi o Kankahi me Kolia, Kem. 73° Ho. 152/100 Kaul e pili ana i ke Kula, Ak. 2° Ho. 350/100 Kaul, e pili ana i ke Kahawai o Anehola, e ili ana 2. Puda

Aina Kalo me Pahale me Kula, onaloko o ka Moa "Kalo" Penei ma Moku ova E hoomaka ana ma ke Kula o Kula, Ak. Ho. o ke Kula o Kula, alaila, Kem. 17° Ho. 3 Kaul e pili ana ina Loi me Kula o Kula, Kem. 56° Ho. 130/100 Kaul e pili ana i ina Loi me Kula o Kula Kem 88° Ho 4 Kaul e pili ana ina Loi o Kamakou, Kem. 2° Ho. 2.30/100 Kaul e pili ana ina Loi o Kamakou. Kem. 82° Ho 30 p. antu e pili ana ina Loi o Puaunahi, Ak. 14° Ho 5.50/100 Kaul, e pili ana ina Loi o Puaunahi, Ak. 72° Ho. 410/100 Kaul, e pili ana i ka pali, e ili ana 1. Eka 2 Puda 25 Perka,

Kauai Aug 10, 1852

W. L. Lee

3

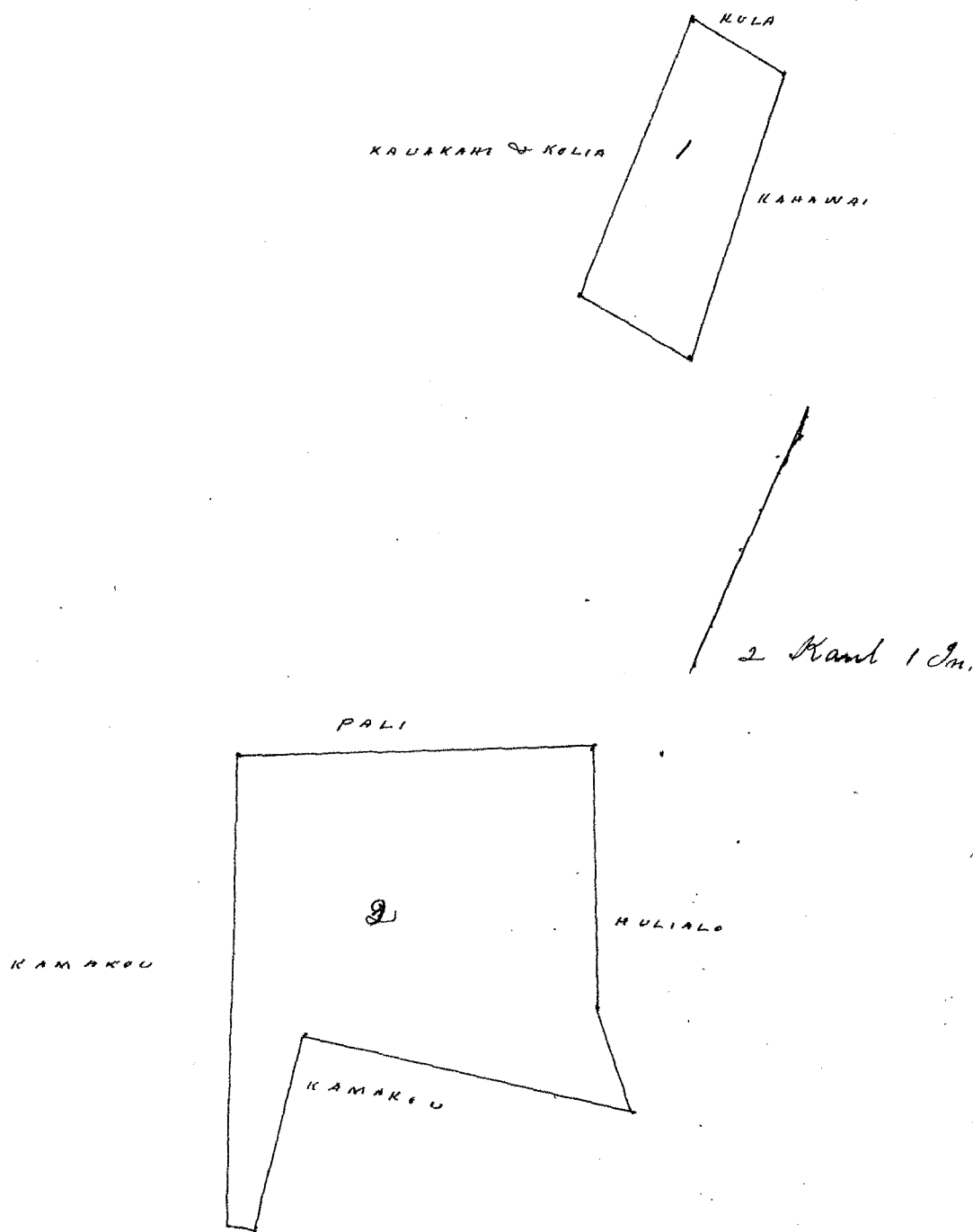

Uku Pau Loa # 6

W. L. Lee
G. M. Robertson
J. Kekaulahao
J. H. Smith

Honolulu, 6, Sep. 1852

Heleu 5023 ~~Kalia~~ Kolia (Golia) Anahola Koolau Kawai

Maloko, ke Ahupuaa Anahola Koolau Kawai.

Apana 1. Akahi Loi "Kuiwani" ka inoa Puni wa Mokuna Chromaka ana ma ke Ka
kawai, ma ke Kapa Ho, ma ke alanui Aupuni, abaita aku, Ak. 8° Ho. 2' Kaul e pili ana
i ke Kahawai, Anahola, Hem. 78° Ho. 1' 3/4 Kaul. e pili ana ina Loi o Konohiki, Hem. 20° Ho. 2' 1/2
Kaul. e pili ana ina Loi o Konohiki, Ak. 60° Ho. 1' 40/100 Kaul. e pili ana ina Loi o Opai, Eili
ana 1 Ruda, 15 Perka,

Apana 2. Pahale ma Kahi o Puhonieni, Puni wa Mokuna, Chromaka ana ma
ke Kula ma Kahi pa laau, abaita aku, Ak. 1° Ho. 3' 1/2 Kaul e pili ana i ke Kula me Pa laau
Ak. 89° Ho. 3' 1/2 Kaul. e pili ana i ke Kula me Pa laau, Hem. 14° Ho. 3' 1/2 Kaul e pili ana i
ke Kula me pa laau, Ak. 88° Ho. 4' Kaul e pili ana i ke Kula me pa laau
Eili ana 1 Eka, 1 Ruda,

Apana 3. Pahale me Iho ia, maloko, ka ihi o Kauakahi Ho, Chromaka ana
ma Kahi pa laau, ma ke Kula, abaita, Hem. 22° Ho. 2' 50/100 Kaul. e pili ana i ka pahale o
Kaulu, Hem. 89° Ho. 2' 1/100 Kaul. e pili ana i ka Loi o Kauakahi, Ak. 15° Ho. 3' 1/100 Kaul.
e pili ana i ka pali, Hem. 75° Ho. 2' 50/100 Kaul e pili ana i ke Kula o Konohiki
Eili ana 2 Ruda, 23 Perka,

Apana 4. Aina Kalo "Kuha" ka inoa, Puni wa Mokuna, Chromaka ana ma
Kahi auwai, ma ke pahu laau, Hem. 88° Ho. 5' 25/100 Kaul. e pili ana ina Loi o Puakekai,
Ak. 33° Ho. 85 pautu e pili ana, ina Loi o Kahu, Hem. 65° Ho. 3' Kaul. e pili ana i ka
Loi o Kahu, Ak. 6' Ho. 1' 92/100 Kaul. e pili ana i ke Kahawai, Hem. 83° Ho. 2' 50/100 Kaul e
pili ana ina Loi o Kukeena, Ak. 86° Ho. 5' 30/100 Kaul. e pili ana ina Loi o Kukeena Ak. 60°
Ho. 80 pautu, e pili ana ina Loi o Kukeena, Hem. 75° Ho. 85 pautu e pili ana i ka auwai
Hem. 22, Ho. 1' 52/100 Pautu e pili ana i ka auwai, Eili ana 1 Eka, 7 Perka,

1. 15
1. 2 23
1. 7
351. 3

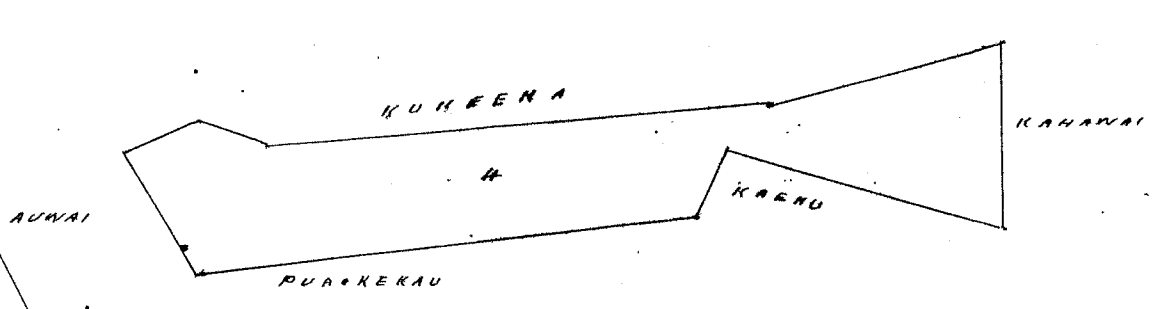
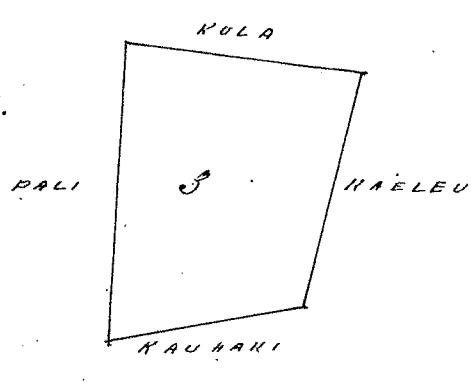
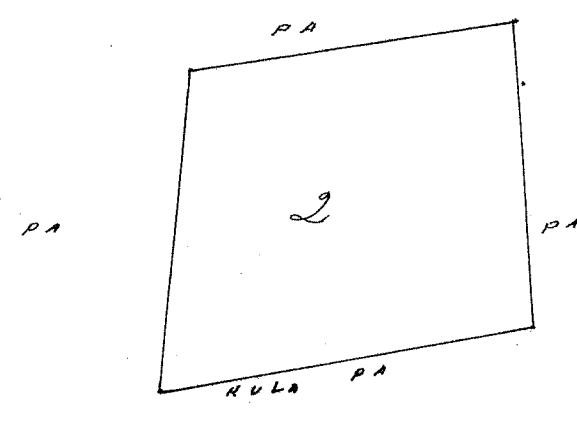
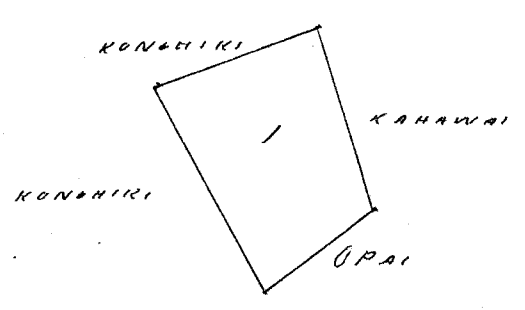

Kawai Aug 16, 1852
W. H. Pease
3

2 Kaul 1 Eka

Wm Pau Son # 8
W. H. Pease
S. M. Robertson
J. Kekaula
J. H. Smith

Honolulu, 6, Sep, 1852

Vol 4554 Matamaku

Anahola Hawaii

Malo o ke Ahupuaa o Anahola, Koolau Hawaii

Apawa 1. Aina Kalo me Pahala, Malo o ka ili o Koolaukai, Penei ma motuna
E hoomaka ana ma ke Kahawai o Anahola, ma ke Kapa Ho, ma ka hi pohaku
Ak. 25° Ho, 50 fua, e pili ana i ke Kula o Konohiki, Hem. 75° Ho, 5 Kaul e pili ana i
ke Kula o Konohiki; Hem. 25° Ho, 1 Kaul, e pili ana i ke Kula o Konohiki; Ak. 67° Ho,
4 90/100 Kaul, e pili ana i ke Kahawai, Eili ana 1 Ruda 19 Perka;

Apawa 2, Aina Kalo me Kula, Malo o ka ili o Koolaukai, Penei ma Motuna.
E hoomaka ana, ma ke Kahawai o Anahola ma ke Kapa Ho, ma ka hi pohaku,
Hem. 70° Ho 1 50/100 Kaul, e pili ana i ke Kula Konohiki; Hem. 52° Ho 5 50/100 Kaul e
pili ana i ka pali; Ak. 70° Ho 1 50/100 Kaul, e pili ana i ke Kahawai o Anahola
Ak. 52, Ho 6 50/100 Kaul e pili ana i ke Kahawai o Anahola
Eili ana 3 Ruda, 26 Perka

Hawaii Aug 14, 1852

W. A. Pease

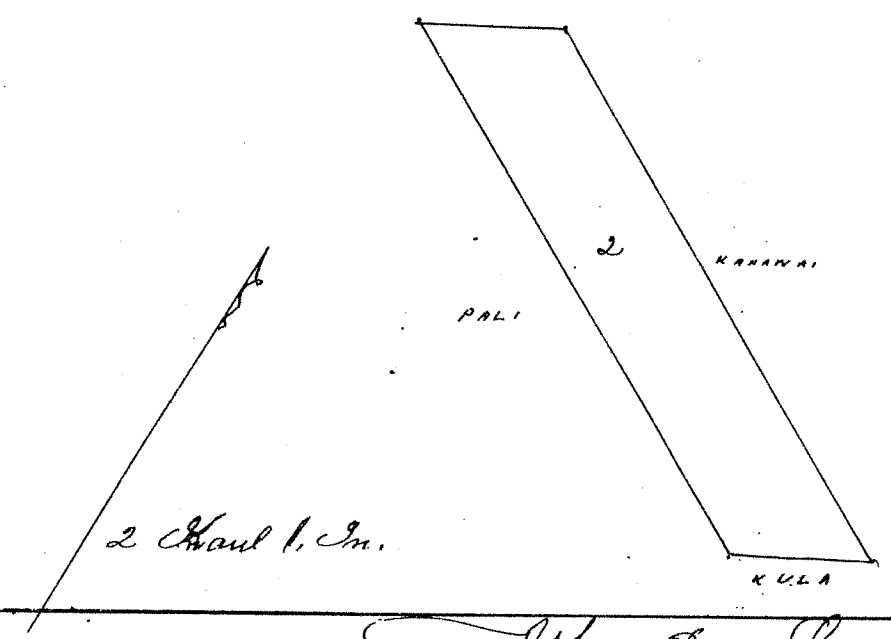
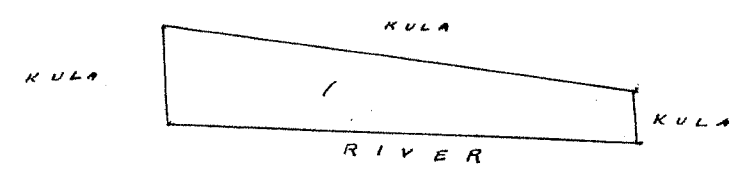

Wm. Pease & Co

W. Pease
G. M. Robertson
J. Kekaulaha
S. H. Smith

Honolulu 6 Sep 1852

Hele 4640 Luau

Anahola Koolau Hawaii

165

Apana 1. Aina Kalo me Kula, Maloko o ka ili o Kihikihi, Ahupuaa o Anahola, Koolau, Hawaii, Penei ma Mokuna, E hoomaka ana ma ke Kahawai o Anahola, ma ke Kapa Ho, ma ka pali o Kihikihi Ak. 8° Ho. 5, 6/100 Kaul e pili ana i ke Kahawai o Anahola, Hem. 80° Ho 80 pautu e pili i ke Pula o Konohiki Hem. 25° Ho. 7 Kaul e pili ana i ke Pula Konohiki, Ak. 79° Ho. 7/100 Kaul, e pili ana i ka pali, e ili ana i Eka, 2 Huda 1 Perka,

Apana 2. Aina Kalo. E hoomaka ana ma ke Iki Hem. Aik. o ma Iki. Kahulomana, alaila aku, Ak. 56° Ho. 4 Kaul, e pili ana iwa Iki o Kahulomana, Hem. 52° Ho. 1, 1/2/100 Kaul e pili ana i ke Kahawai, Hem. 56° Ho. 4, 8/100 Kaul e pili ana iwa Iki o Kahulomana, Ak. 20° Ho. 1, 3/100 Kaul e pili ana i ke Pula o Konohiki, e ili ana i 2 Huda 1 Perka

Hawaii Aug 10, 1852

W. H. Pease

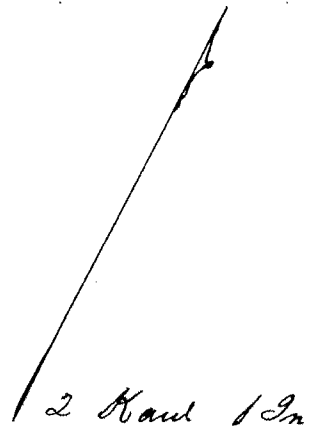
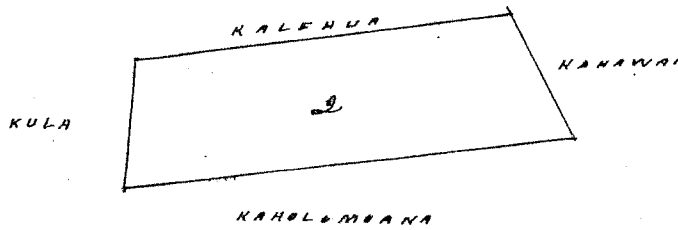
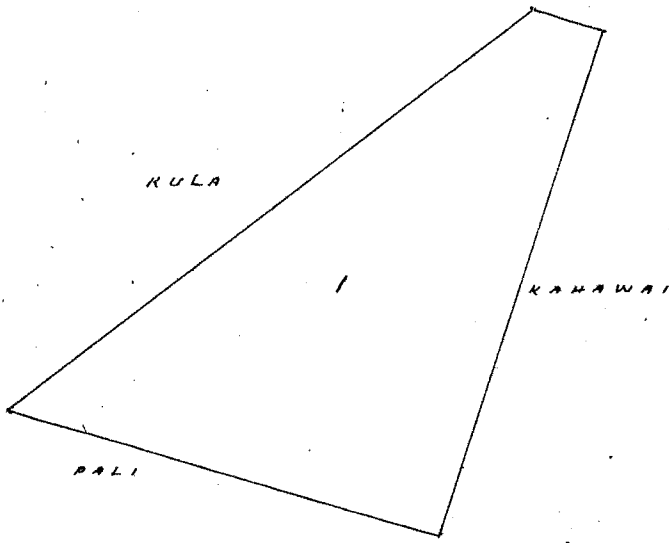

W. H. Pease Draft 6

W. H. Pease
G. M. Robertson
J. H. Kaulahao
J. H. Smith

Honolulu 6 Sep 1852

Hele 5199 Kucha

Anahola Koolau Hawaii

Maloko o ke Ahupuaa o Anahola Koolau Hawaii,

Apana 1. Aina Kalo, Maloko o ka ili o Kaluaopu, Penei ma Mokuna, E hoomaka ana ma ka pali ma ke Kapa Konohiki, ma Iki o Kalawaiamui ma ka hiki Kala, alaila aku Ak. 35° Ho. 2, 7/100 Kaul e pili ana iwa Iki o Kalawaiamui, Ak. 23° Ho. 40 pautu e pili ana iwa Iki o Kalawaiamui, Ak. 40° Ho. 4 Kaul, e pili ana iwa Iki o Kalawaiamui, Hem. 81° Ho. 70 pautu e pili ana, iwa Iki o Lonoiki, Ak. 30° Ho. 1, 7/100 Kaul e pili ana iwa Iki o Lonoiki, Ak. 40° Ho. 1, 2/100 Kaul e pili ana iwa Iki o Lonoiki, Ak. 82° Ho. 80 pautu e pili ana iwa Iki o Lonoiki, Hem. 26° Ho. 7, 9/100 Kaul e pili ana i ke Kahawai, Ak. 50° Ho. 2 Kaul, e pili ana iwa Iki o Konohiki E ili ana i Eka,

Apana 2. Pahale maloko o ka ili o Puamano, Penei ma Mokuna, E hoomaka ana ma ke Pula, ma ka hiki pa laau, alaila aku, Ak. 80° Ho. 1, 20/100 Kaul e pili ana i ke Pula o Konohiki, Ak. 20° Ho. 1, 5/100 Kaul, e pili ana i ke Pula o Konohiki, Hem. 80° Ho. 1, 20/100 Kaul e pili ana i ke Pula Konohiki, Hem. 20° Ho. 1, 5/100 Kaul e pili ana i ke Pula o Konohiki E ili ana i 8 Perka,

Hawaii, Aug. 14 1852

W. H. Pease

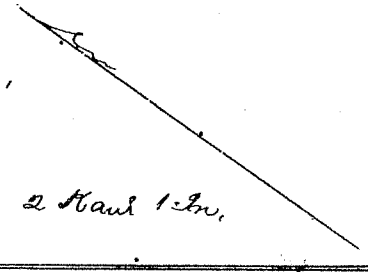
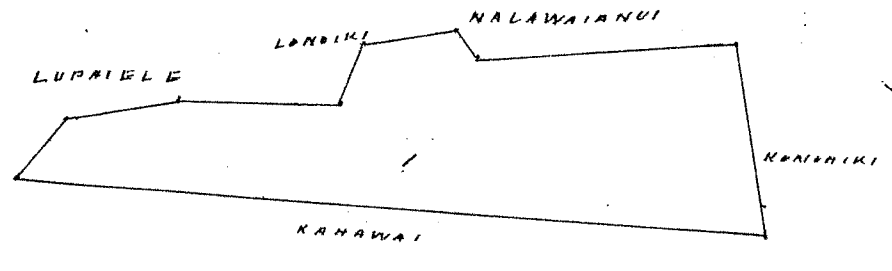
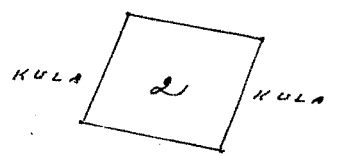

Wku Pan Loa # 6
 W. H. Ke
 G. M. Robertson
 J. Kikaulahao
 J. H. Smith

Honolulu 6 Sep 1852

Wku 5084 Konohiki

Aina Kalo Kula, Maloko o ka ili o "Iwawala" Ahupuaa o Anahola Koolau Kawai
 Penei na Mokuna, E hoomaka ana owa ke Kahawai o Kaula, ma ke Kapa Kema ma
 kaahi pohaku, kem, 20° ki. l. Kaul, e pili ana i ke Kula o Konohiki, kem, 72° ki. l. 20/100 Kaul
 e pili ana i ke Kahawai, Ak, 20° ki. l. Kaul, e pili ana i ke Kula o Konohiki Ak, 72° ki
 l. 20/100 Kaul, e pili ana i ka pali, e ili ana i Puda, J. Perka.

Kawai Aug 10, 1852

W. H. Pease

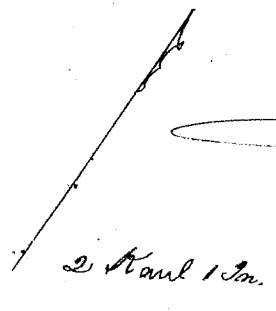
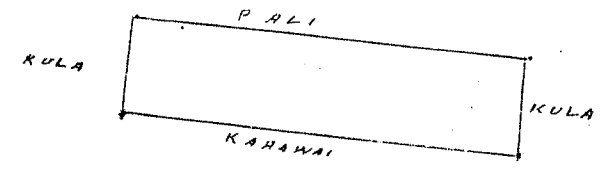

Wku Pan Loa # 4
 W. H. Ke
 G. M. Robertson
 J. Kikaulahao
 J. H. Smith

Honolulu 6 Sep 1852

Wku 4591 Koolau

Anahola Koolau Kawai

Aina Kalo Ma Kula, Maloko o ka ili o Iwawala, Ahupuaa o Anahola Koolau Kawai
 Penei na Mokuna, E hoomaka ana owa ke Kapa Kema ma kaahi pohaku, alaila
 Ak, 10° ki. l. Kaul, e pili ana i ke Kula o Konohiki, Ak, 78° ki. l. 10/100 Kaul, e pili ana
 i ke Kahawai, kem, 10° ki. l. Kaul e pili ana i ke Kula, kem, 78° ki. l. 10/100 Kaul e
 pili ana i ka pali, e ili ana i Puda, J. Perka

Kawai Aug 10, 1852

W. H. Pease

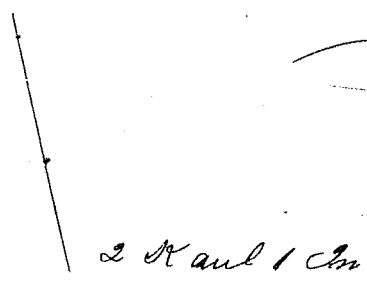
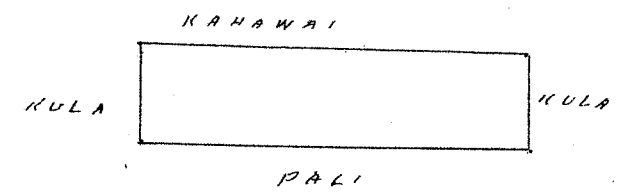

Wku Pan Loa # 4
 W. H. Ke
 G. M. Robertson
 J. Kikaulahao
 J. H. Smith

Honolulu 6 Sep 1852

Helu 4712 Makaimo Heiko

Anahola Koolau Hawaii

Aina kahi ome Kula Maloko ka ili o Kioka Ahupuaa o Anahola Koolau Hawaii
Penei wa Mokuna, E hoomaka ana oia ke Kahawai o Anahola, oia ke Kapa Ikiina oia
Kahi pihaku, Kem. 62° Ki. 4, 10/100 Kaul e pili ana i ke Kula o Honolulu Kem. 5° Ki. 2 Kaul e pili
ana i ka pali, Ak. 62° Ki. 4 30/100 Kaul. e pili ana i ke Kula o Honolulu Ak. 9° Ki. 1 95/100 Kaul,
e pili ana i ke Kahawai o Anahola, E ili ana i Ruda 6 Perka,

Hawaii Aug 10 1852

M. H. Pease,

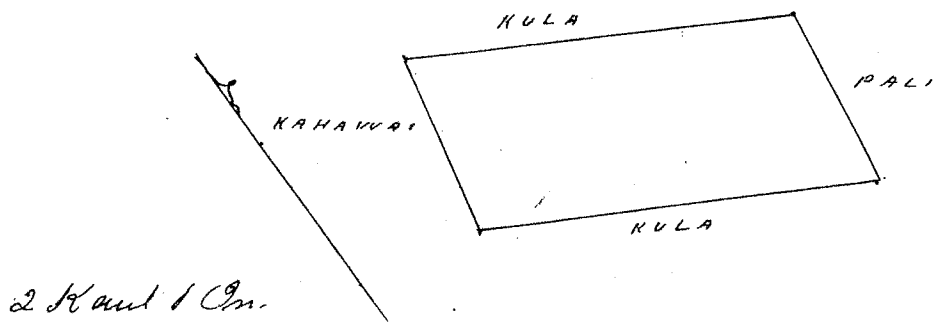

Uku Pau Loa / L

- M. H. Pease
- G. M. Robertson
- J. Kekaulahao
- J. H. Smith

Honolulu 6 Sep 1852

Helu 4719 Makaola

Anahola Koolau Hawaii

Aina kahi Kula, Maloko ka ili o Hoopala, Ahupuaa o Anahola Koolau Hawaii,
Penei wa Mokuna, E hoomaka ana oia ke Kahawai, oia ke Kapa Akau, oia Kahi pihaku
alaila, Ak. 55° Ki. 50 paku e pili ana i ke Kula Honolulu, Kem. 4, 50° Ki. 4, 10/100
Kaul e pili ana i ka pali, Kem. 55° Ki. 80 paku e pili ana i ke Kula, Ak. 53° Ki. 1, 30/100
Kaul, e pili ana i ke Kahawai, Ak. 35° Ki. 2 30/100 Kaul, e pili ana i ke Kahawai,
e ili ana i Ruda, 5 Perka,

Hawaii Aug 10, 1852

M. H. Pease,

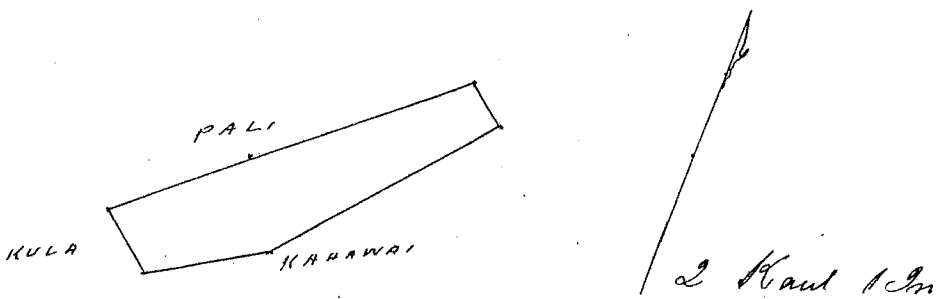

Uku Pau Loa / L

- M. H. Pease
- G. M. Robertson
- J. Kekaulahao
- J. H. Smith

Honolulu 6 Sep 1852

Helu 4971 Kaalehua

Anahola K. Hawaii

Aha Loi ome Kula "Kaanawa" Ka inoa, Maloko ke Ahupuaa o Anahola Koolau Hawaii,
Penei wa Mokuna, E hoomaka ana oia ke Kahawai, oia ke Kahi Kem. Ki. oia Loi o Puwa
abgila aku, Kem. 56° Ki. 6 Kaul, e pili ana iwa Loi o Puwa, Kem. 45° Ki. 1 55/100 Kaul e pili ana
i ka pali, Ak. 56° Ki. 6 Kaul, e pili ana iwa Loi o Hoopala, Ak. 45° Ki. 1 55/100 Kaul
e pili ana i ke Kahawai, e ili ana i Ruda, 25 Perka

Hawaii Aug 10 1852

M. H. Pease,

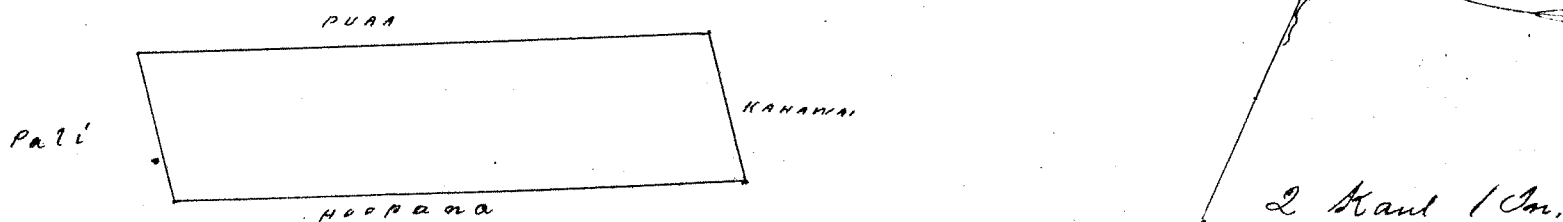

Wku Pau Loa & L.
W. H. H. H.
G. M. Robertson
J. K. Kaulahao
J. H. Smith

Honolulu 6 Sep 1852

Volu 5203 ²⁰⁵ Koolomoana Anahola K. Kawai

E hua Loi, Maloko, ka ili o Anahola Ahupuaa o Anahola Koolau Kawai
Penei na Mokuna E hoomaka ana ma ke Kiki Kem. Ho, o wa Loi. Puaa
alaila Aka. Ak. 56° 41' 1/2" Kaul. e pili ana ina Loi. Puaa, Ak. 30° Ho 1/2" 1/100
Kaul. e pili ana i ke Kaulawai, Kem. 56° Ho 1/2" Kaul. e pili ana ina Loi o
Konoehiki, Kem. 30° 41' 1/2" Kaul. e pili ana i ke Pula o Konoehiki
e ili ana 1 Puda, 30 Perka,

Kawai Aug 10, 1852

W. H. Pease

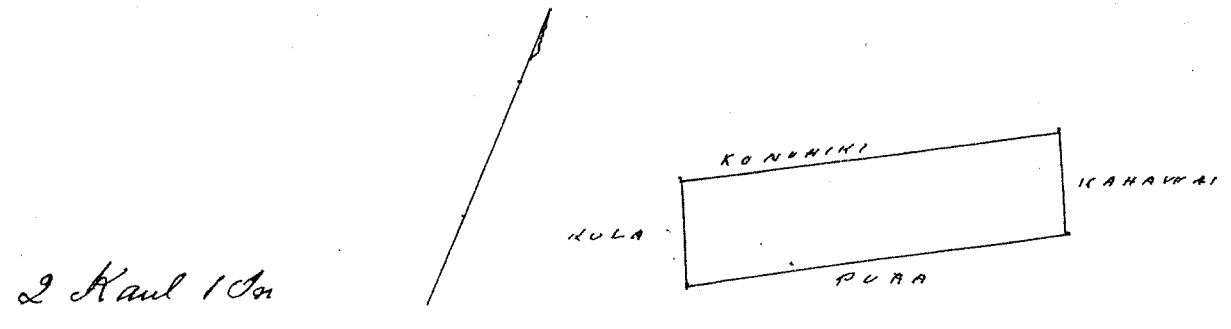

Wku Pau Loa & L.
W. H. H. H.
G. M. Robertson
J. K. Kaulahao
J. H. Smith

Honolulu 6 Sep 1852

Volu 4981 ²⁰⁵ Kealimalele Anahola K. Kawai

E Kolu Loi me Pula, Maloko, ke Ahupuaa o Anahola Koolau Kawai Penei na Mokuna
E hoomaka ana ma kaali pookaku, ma ka pali, Ak. 59° 41' 1/2" Kaul e pili ana i
ke Pula o Konoehiki Ak. Lo. Ho. 2 1/100 Kaul e pili ana ina Loi o Konoehiki Ak. 57° 41'
2 3/100 Kaul. e pili ana i wa Loi o Konoehiki, Ak. 55° Ho. 2 7/100 Kaul e pili ana ina
Loi o Konoehiki Kem Lo. Ho. 2 6/100 Kaul e pili ana i ka pali, Kem. 35° 41' 3 2/100
Kaul e pili ana i ka pali, e ili ana 3 Puda, 20 Perka

Kawai, Aug. 10, 1852

W. H. Pease

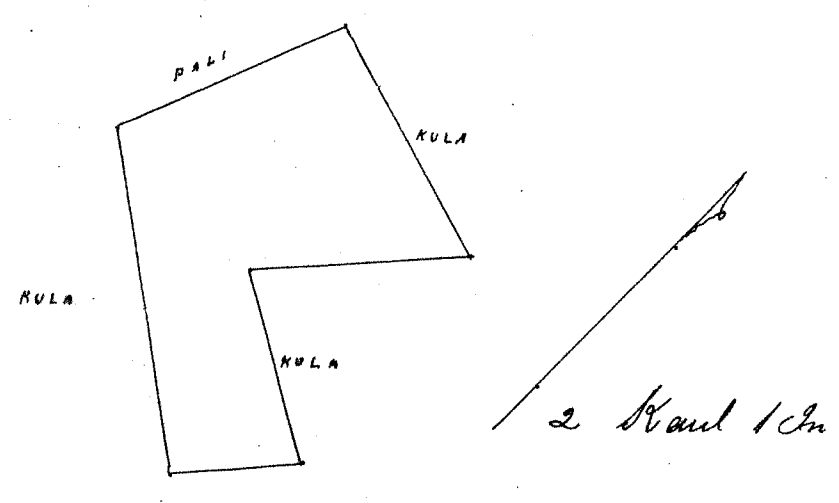

Wku Pau Loa & L.
W. H. H. H.
G. M. Robertson
J. K. Kaulahao
J. H. Smith

Honolulu 6 Sep 1852

Helu 4611 Tokake ✓

Anahola Koolau Hawaii

Aiwa Kalo me Pahale, maloko ka ili. Manaiiki Ahupuaa. Anahola Koolau Hawaii, Puni na mokuna. E hoomaka ana ma ke Kahawai. Anahola, ma ke Kapa Hiki ma Kahi pahaku. Num. 60° Ni. 5 50/100 Kaul. e pili ana i ke Kula. Konohiki, Num. 40° Ni. 3 Kaul. e pili ana i ke Kapa Hiki. Num. 88° Ni. 4 Kaul. e pili ana i ke Kula. Konohiki. Num. 2° Ni. 3 20/100 Kaul. e pili ana i ke Kahawai, Num. 32° Ni. 2 Kaul. e pili ana i ke Kahawai e ili ana 2 Eka,

Hawaii, Aug 10, 1852

M. H. Pease

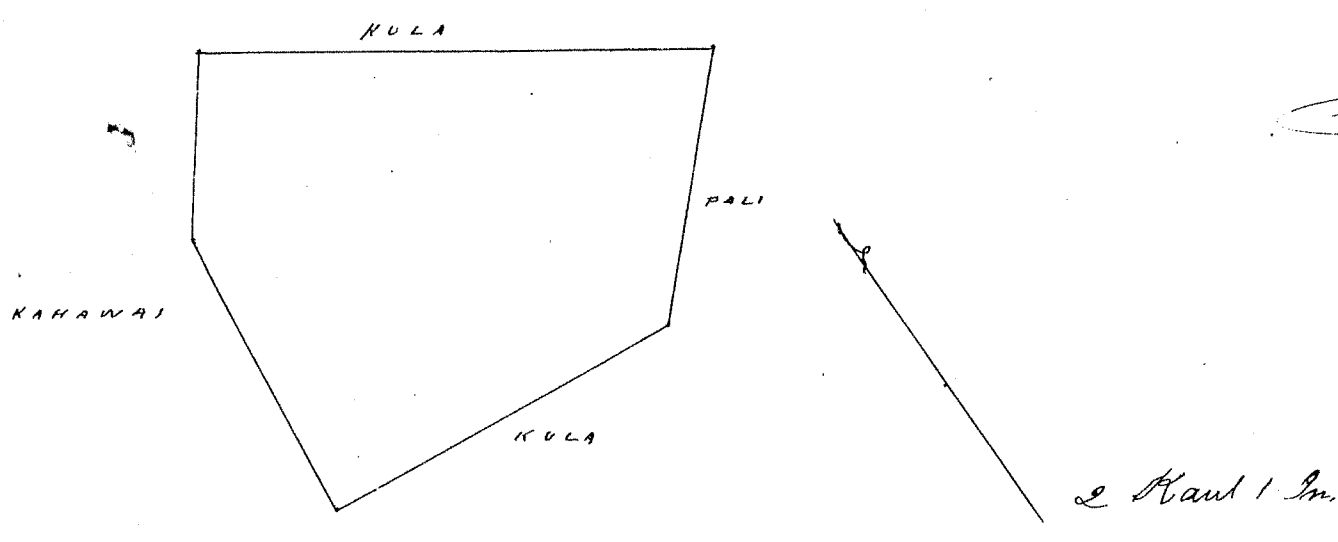

Wm Parson 6
W. H. Pease
G. M. Robertson
J. Kekaulahao
J. H. Smith

Honolulu, 6 Sep 1852

Helu 4656 Iwa ✓

Anahola Hawaii

Aiwa Kalo me Kula, maloko ka ili "Kanaia", Ahupuaa o Anahola, Koolau, Hawaii, Puni na Mokuna. E hoomaka ana ma ke Kahawai. Anahola, ma ke Kapa K, ma Kahi pahau laau. Num. 65° Ni. 1 10/100 Kaul. e pili ana i ke Kula. Konohiki, Num. 22° Ni. 2 20/100 Kaul. e pili ana ina Iwa. Konohiki, Num. 85° Ni. 4 50/100 Kaul. e pili ana ina Iwa. Kaula, Num. 64° Ni. 4 50/100 Kaul. e pili ana i ke Kahawai o Anahola e ili ana 2 Puda 25 Perka

Hawaii, Aug. 10, 1852

M. H. Pease

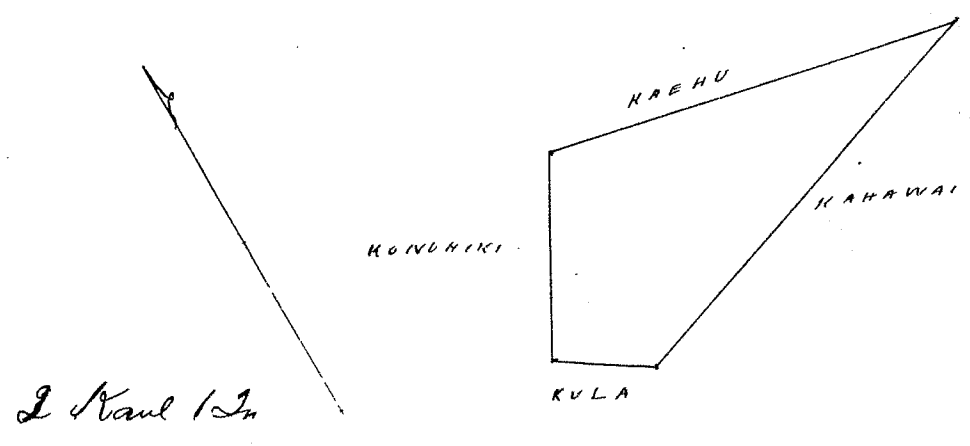

Wm Parson 4
W. H. Pease
G. M. Robertson
J. Kekaulahao
J. H. Smith

Honolulu, 6 Sep 1852

Hele 4984 Hale

Anahola Kawai

Aina Kalo Maloko o ke Ahupuaa o Anahola, ili o Kaluaohiki, Koolau, Kawai, Penei wa Mokuna, E hoomaka ana ma ke Kahi A. Ki, o Kaluaohiki, alaila aku, Ak. 75° Ki. 104/100 Kaul e pili ana ina Loi o Kunene, Ak. 26° Ki. 5 20/100 Kaul, e pili ana i Kahi Anwai, Kem. 50° Ki. 2 20/100 Kaul, e pili ana i ka loi o Kapunoni, Kem. 20° Ki. 4 60/100 Kaul e pili ana i Kukuluuki, e ili ana 3 Puda 16. Perka,

Kawai Aug 10, 1852

M. A. Pease

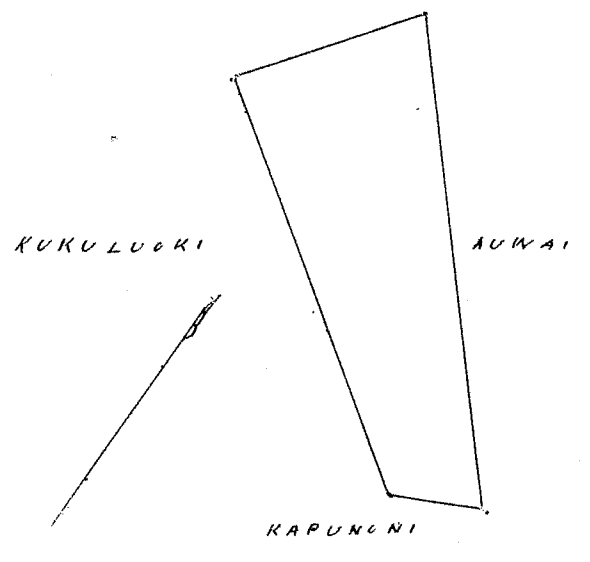

M. A. Pease

See Page 724. Vol. 3. towards Books.

Wai Pau Loa \$ 3.00
W. Pease
G. M. Robertson
J. Kekaulahao
J. H. Smith

Honolulu 6 Sep. 1852

Hele 5142 Hale

Anahola Kawai

Aina Kalo Maloko o ka ili "Kamoku" Ahupuaa o Anahola, Koolau, Kawai, Penei wa Mokuna, E hoomaka ana ma ke Kahi A. Ki, o ka Loi "Kekoa" ka inoa alaila aku, Ak. 22° Ki. 1 Kaul. e pili ana i ke Kula o Konoohiki, Kem. 85° Ki. 1 Kaul e pili ana i wa Loi o Piawe Ak. 79° Ki. 15 0/100 Kaul. e pili ana ina Loi o Piawe Kem. 86° Ki. 1 50/100 Kaul e pili ana ina Loi o Piawe Kem. 15° Ki. 1 30/100 Kaul. e pili ana ina Loi o Konoohiki Ak. 86° Ki. 1 Kaul e pili ana ina Loi o Konoohiki e ili ana 1 Puda 29 Perka

Kawai Aug 10 1852

M. A. Pease

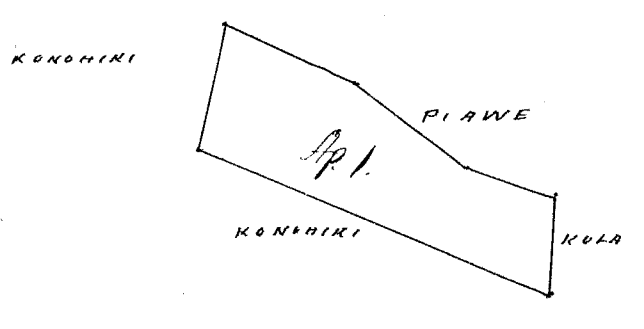

2 Kaul 1 ch.

1. 29 P.
V. 3. p. 724
1-25
3P 14

Wai Pau Loa \$ 4
W. Pease
G. M. Robertson
J. Kekaulahao
J. H. Smith

Honolulu 6 Sep. 1852

Aina Kale Pahale, me Kula, Maloko, ka ili. Ananahini Ahupuaa. Anahola Koolau Kawai, Penei ma Mokuna, E hoomaka ana ma ke Kahawai. Anahola, ma ke Kapa Ni: ma Kahi pohaku, alaila aku. Kem. 30; Ni: 2, 6/100 Kaul. e pili ana i ke Kula. Konoiki, AK. 45° Ni: 5 Kaul. e pili ana i ka pali, AK. 42° Ni: 4, 6/100 Kaul. e pili ana i ka pali, Kem. 20° Ni: 5 Kaul. e pili ana i ke Kahawai, e ili ana i Eka 3 Puda.

Kawai Aug 14 1852

M. A. Pease

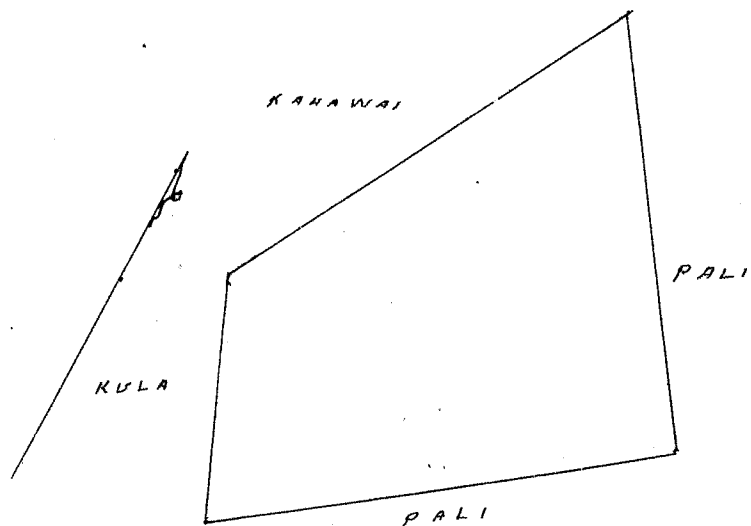

2 Kaul 1 In

W. Kau Ipa 5

- M. Pease
- G. M. Robertson
- J. Kikaulahas
- J. H. Smith

Honolulu 6 Sep 1852

Aina Kale Kula me Pahale maloko, ka ili. Akaka, Ahupuaa. Anahola Koolau Kawai, Penei ma Mokuna, E hoomaka ana ma ke Kahawai. Anahola, ma ke Kapa Niikina ma Kahi pohaku. Kem. 20° Ni: 6, 5/100 Kaul. e pili ana i ke Kula me Pali. Kem. 30° Ni: 3, 5/100 Kaul. e pili ana i ke Kula me pali, AK. 10° Ni: 2, 6/100 Kaul. e pili ana i ke Kula me pali, AK. 70° Ni: 8, 7/100 Kaul. e pili ana i ke Kahawai. Anahola e ili ana i Eka, 3 Puda, 10 Perka.

Kawai Aug 14 1852

M. A. Pease

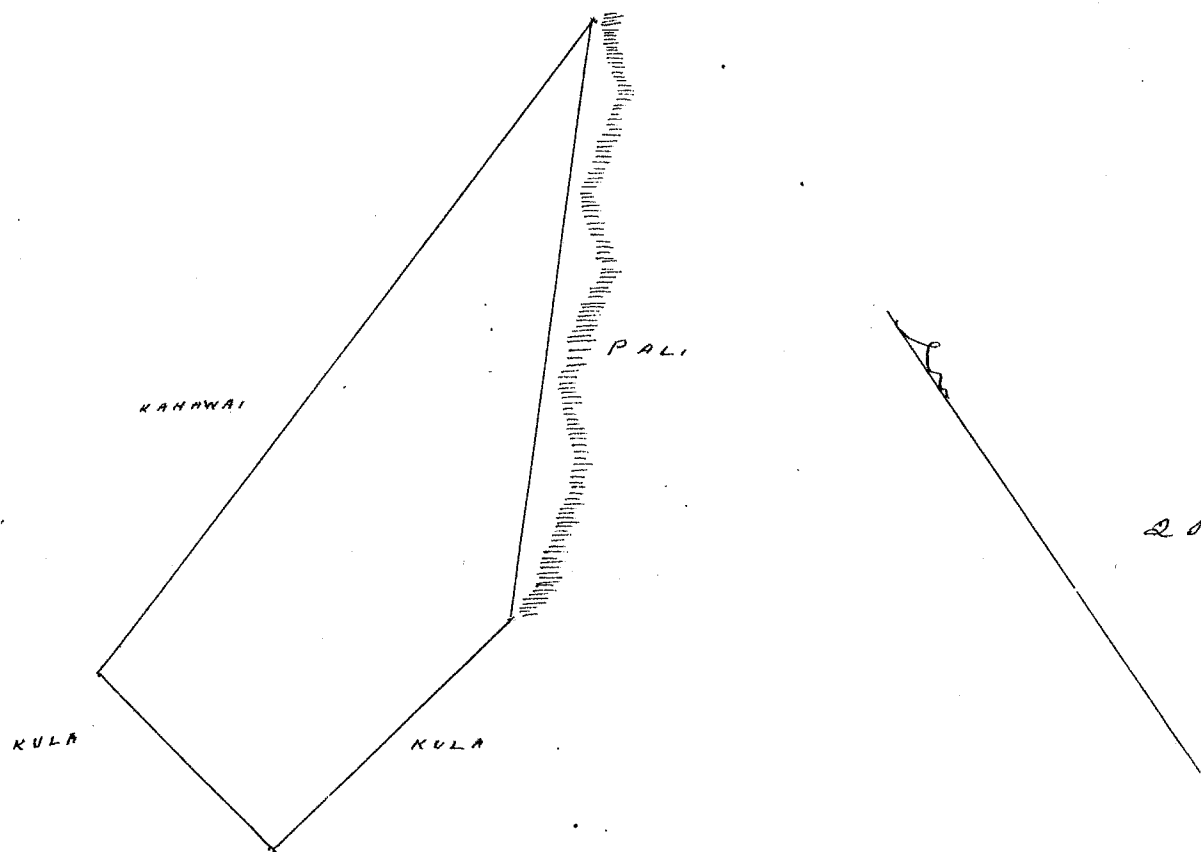

2 Kaul 1 In

W. Kau Ipa 5

- M. Pease
- G. M. Robertson
- J. Kikaulahas
- J. H. Smith

Honolulu Oahu 6 Sep 1852

Hele 4636 Tuakawala

Hiomanu Kawai

Matoko o ke Ahupuaa o Hiomanu Puna Kawai.

Apuna 1. Pahale matoko o ka ili o Kaluhau, Penei o Mokuna, Chomaka ana, ma ke Kai. ma alanui, ma Kahi pahu laau, alaila aku. Num. 30° Hi. 2, Kaul. e pili ana i ke Kai, Num. 60° No 150/100 Kaul. e pili ana i ke Kula o Konohiki, Ak. 30° No 2 Kaul. e pili ana i ke Kula o Konohiki Ak. 60° Hi. 150/100 Kaul. e pili ana i ke Kula o Konohiki, e ili ana, 1. Puda, 8 Perka,

Apuna 2, Aina Kalo ma Kula, ma ka ili o Kapahupoko, Penei o Mokuna, e hoomaka ana ma ka pali ma Kahi pahu laau, alaila aku. Ak. 10° Hi. 2, Kaul. e pili ana i ka lani o Pookina Ak. 45° Hi. 1 Kaul. e pili ana i na lani o Pookina, Ak. 15° Hi. 50 pahu, e pili ana i na lani o Pookina, Ak. 85, No. 3, 70/100 Kaul. e pili ana i ka pali wai o Hiomanu, Num. 5° No 250/100 Kaul. e pili ana i ke Kula o Konohiki Ak. 70° Hi. 120/100 Kaul. e pili ana i ka pali e ili ana 2 Puda,

Kawai, Aug. 10 1852

W. A. Pease

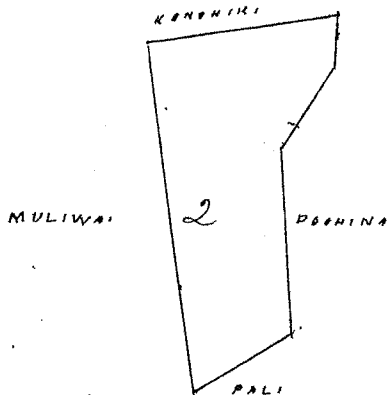
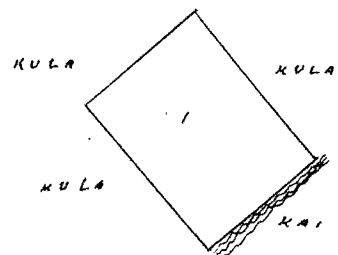

2 Kaul. 1 In.

Wm. Pau Lee

W. A. Pease
G. W. Robertson
J. Kekaulaha
J. H. Smith

Honolulu 6 Sep. 1852

Hele 2597 Puolo

Hiomanu Puna Kawai

Matoko o ke Ahupuaa o Hiomanu Puna Kawai.

Aina Kalo ma Kula, e lima lani, Penei o Mokuna, Chomaka ana ma ke Kula, ma ke Kahi, Ke. Ke. o na lani o Konohiki alaila aku. —

Ak. 18° No. 3, 50/100 Kaul. e pili ana i na lani o Konohiki; Num. 89° No 100/100 Kaul. e pili ana i ke Kula o Konohiki, Num. 10° No. 2, Kaul. e pili ana i ke Kula o Konohiki; Num. 30° Hi. 150/100 Kaul. e pili ana i ke Kula o Konohiki; Ak. 89° Hi. 150/100 Kaul. e pili ana i ke Kula o Konohiki e ili ana 2 Puda 15 Perka

Kawai Aug 10 1852

W. A. Pease

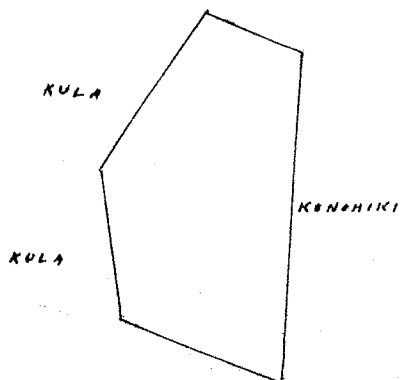

2 Kaul. 1 In.

Wm Paul & Co
Wm
G. M. Robertson
J. Kaulahao
J. H. Smith

Honolulu 6 Sep 1852

Hele 4 25 Puhina / Niimani Puna Hawaii

Maloko . ke Ahupuaa . Niimani Puna Hawaii . 1 P

Apawa 1. Pahala, maloko . ka ili . Puhala, Penei ma Mokuana, Chomaka ana ma ke Kula . Konoehiki, ma Kahi paha laau, Ak. 30° No. 2, Kaul. e pili ana i ke Kula o Konoehiki, Ak. 60° No. 2, 1/100 Kaul. e pili ana i ke Kula o Konoehiki, Hem. 40° No. 2, Kaul. e pili ana i ke Kula me Kahi paha laau, No. 60° No. 2, 1/100 Kaul. e pili ana i ke Kula me ka pa laau, E ili ana i Kula, 26 Perka.

Apawa 2. Aina Kalo me Kula, Penei ma Mokuana. Chomaka ana ma ke Kula, ma ke Kahi No. No. o ma Ii, Kahawaiolaa alaila aku, Ak. 18° No. 2 Kaul. e pili ana ma Ii. Kahawaiolaa, Ak. 32° No. 1, 1/100 Kaul. e pili ana i ka Ii Konoehiki, Hem. 70° No. 1, 1/100 Kaul. e pili ana i ka Muliwai . Niimani, Hem. 20° No. 1, 1/100 Kaul. e pili ana i ka Muliwai o Niimani, Hem 65° No. 1 Kaul. e pili ana i ka aina . Puakauala, Ak. 6° No. 3, 95/100 Kaul. e pili ana i ka aina . Puakauala, Ak. 18° No. 2, 50/100 Kaul. e pili ana i ka pali; Ak. 45° No. 1, 50/100 Kaul. e pili ana i ka pali; Ak. 10° No. 1, 50/100 Kaul. e pili ana i ke Kula o Konoehiki; Ak. 60° No. 1, 2/100 Kaul. e pili ana i ke Kula o Konoehiki; Ak. 15° No. 1 Kaul. e pili ana i ke Kula Konoehiki; Hem. 28° No. 50 paha e pili ana i ke Kula o Konoehiki e ili ana i ka 20 Perka.

Hawaii, Aug. 10 1852

W. A. Pease

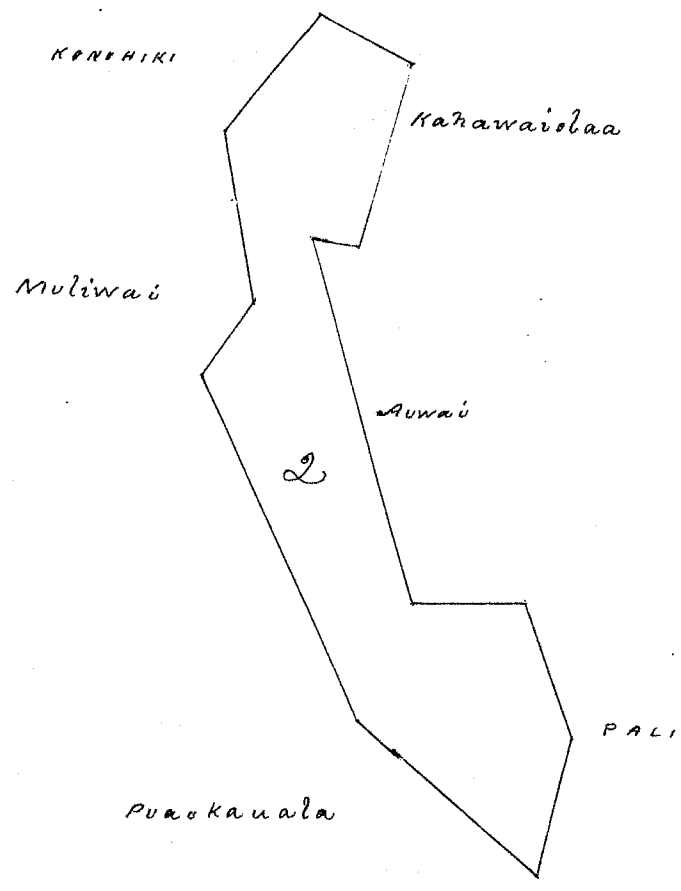
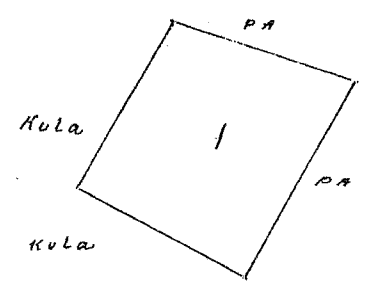

Wm Paul & Co
Wm
G. M. Robertson
J. H. Smith
J. Kaulahao

Honolulu 6 Sep. 1852.

Hulu 5024 Kaula

Miomamu Kawai

Maloko. ke Ahupuaa. Miomamu Tuna Kawai,

Apawa 1. Pahale, maloko. ka ili. Kealohimaniie
E hoomaka ana ma ke Alanui Aupuni, ma kaahi pohaku nui, alaila aku,
Kem. 54° N. 2.50/100 Kaul. e pili ana i ke Alanui Aupuni, Ak. 79° N. 2 Kaul. e pili ana
i ke Alanui Aupuni, Ak. 26° N. 3.30/100 Kaul. e pili ana i ke Kai, Kem. 60° N. 4 Kaul.
e pili ana i ke Kula Konohiki; e ili ana 3 Puda, 33 Perka,

Apawa 2. E Kolu Loi, ma Kula, Maloko. ka ili. Luhau, E hoomaka ana
ma ke Kai ma ka Muliwai, o Miomamu, alaila aku,
Kem. 88° N. 3 Kaul. e pili ana i ka Muliwai o Miomamu, Kem. 22° N. 2.50/100 Kaul.
e pili ana iwa Loi. Kahawaioloa, Ak. 62° N. 80 pautu e pili ana iwa Loi o
Kahawaioloa, Kem. 32° N. 5 Kaul. e pili ana iwa Loi. Kahawaioloa, Ak. 75°
N. 4 Kaul. e pili ana i ke Kula, Konohiki; Ak. 48° N. 7.55/100 Kaul. e pili
ana i ke Kai, e ili ana 2 Eka, 10 Perka

Kawai, Aug. 10, 1852,

W. A. Pease

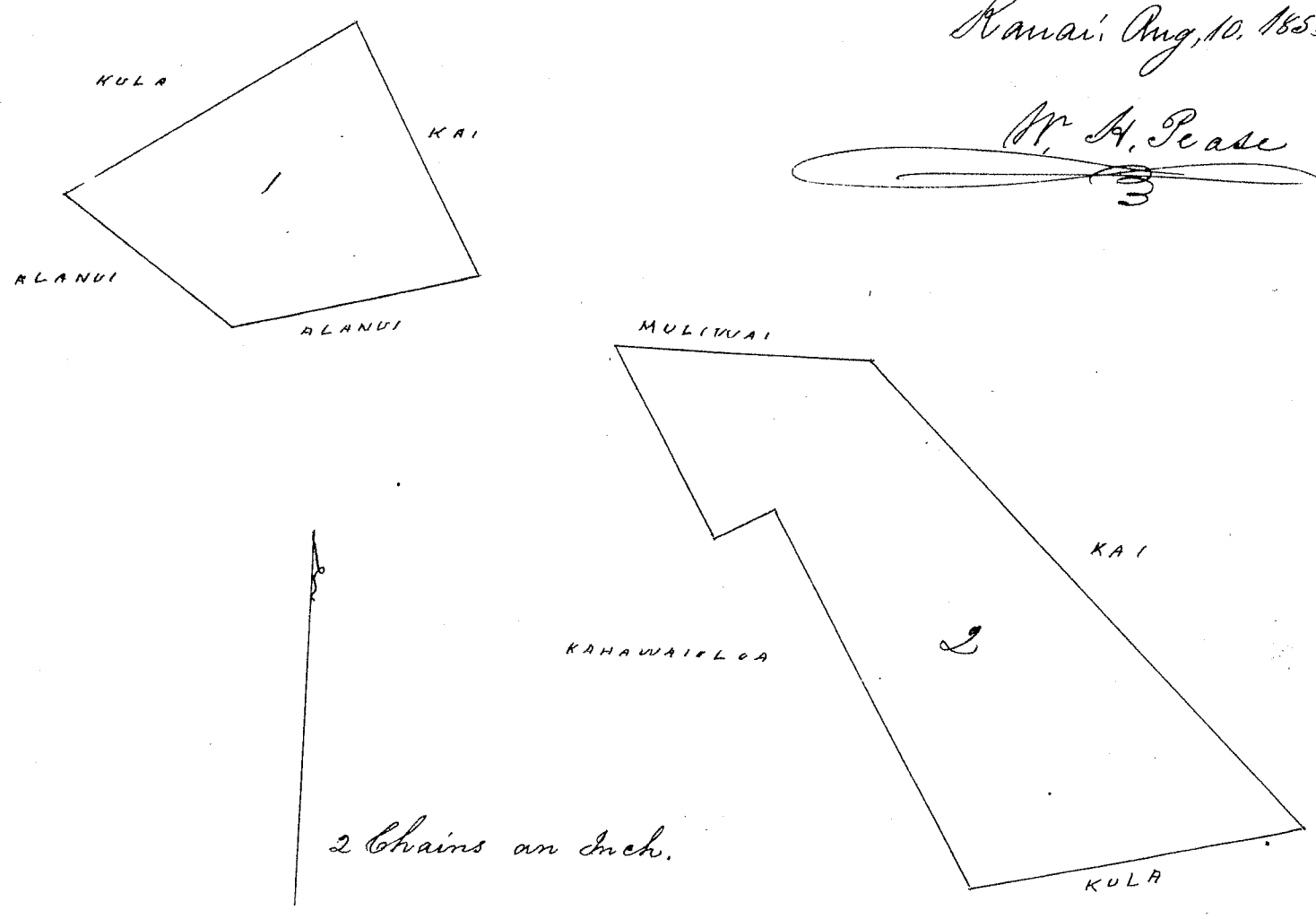

Wm Pau Loa
W. A. Pease
G. M. Robertson
J. Kekaulahao
J. H. Smith

Honolulu 6 Sep 1852

Hulu 5087 Kahawaioloa

Miomamu Kawai

Maloko. ke Ahupuaa. Miomamu Tuna Kawai,

Apawa 1. Pahale, Maloko. ka ili. Kahauan, Penei ma motuna, E hoomaka
ana ma kaahi pahau laau, ma ke Kula o Konohiki; alaila aku,
Kem. 72° N. 2 Kaul. e pili ana i ke Kula o Konohiki; Kem. 20° N. 3.30/100 Kaul.
e pili ana i ka Muliwai o Miomamu, Ak. 50° N. 3.10/100 Kaul. e pili ana i
ka Muliwai o Miomamu, Ak. 45° N. 2.30/100 Kaul. e pili ana i ke Kula o
Konohiki; e ili ana 2 Puda, 38 Perka,

Apawa 2. E Lima Loi, Maloko. ka ili. Kapaula, Penei ma motuna
E hoomaka ana ma ke Kula o Konohiki; ma ke Kahi oke, N. o na Loi, o Pohina
Ak. 48° N. 2 Kaul. e pili ana iwa Loi, o Pohina, N. 32° N. 1.30/100 Kaul. e pili
ana iwa Loi. Keaka, Ak. 62° N. 80 pautu e pili ana iwa Loi. Keaka

Mem. 32° Ni. L. Kaul. e pili ana i na Lōi. Keaka, Mem. 60° No. 3. Kaul. e pili ana i
Ke Kula. Konohiki. Ak. 30° No. 4, 9/100 Kaul. e pili ana i Ke Kula. Konohiki
e ili ana 1 Eka, 3 Puda 8 Perka.

Hawaii Aug. 10, 1852,

Mr. H. Pease,

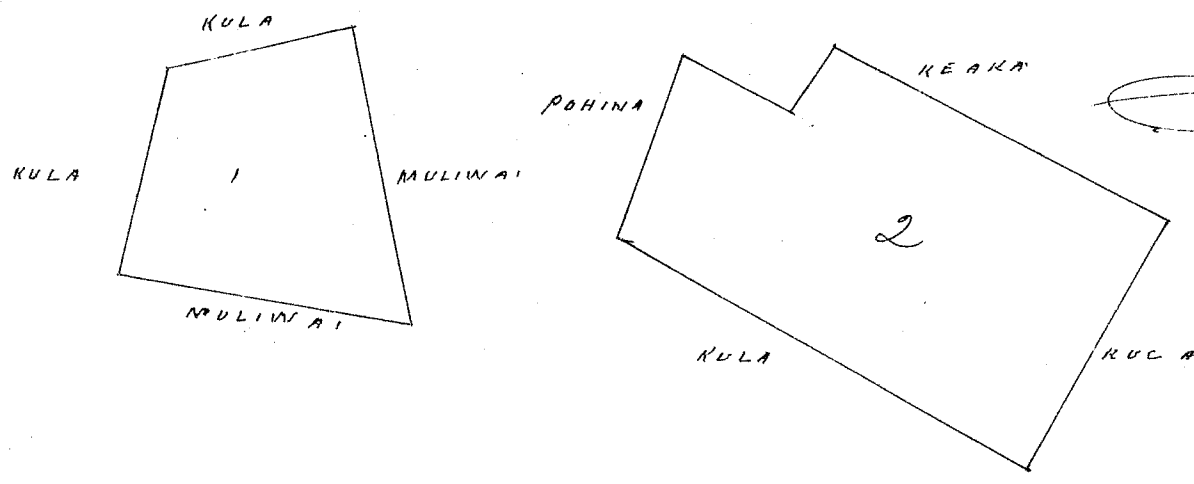

Wku Pau Loa # 6

W. H. Pease
G. M. Robertson
J. H. Kaulahao
S. H. Smith

Honolulu Oahu 6 Sep 1852

Wku 3414 B Puaiki () Paalaa Kaula Oahu

Ko Puaiki Kuleana ma Paalaa a iu Kawaihoa

Apana 1. Kahuahale Paalaa Kai, Aoomaka ma ke Kiki. Ko. H. o ka Kahuahale. Holo. Mem. 75° Ni. 2.50 ma Kahuahale. Holo. Ak. 15° Ni. 1.00 Ma ka pa aina Ak. 75° No. 2.50 ma ka pa aina, Mem. 15° No. 1.00 ma ke alanui i ke Kiki mua, Area, 0.25 o ka Eka.

Apana 2. Aoomaka ma Ke Ehu, pa hale Kiki Ko. H. Holo. Ak. 35° Ni. 1.04 ma ka pa, Holo. Ak. 14 1/2° Ni. 3.24 ma ka pa kahiko, Mem. 26 1/2° Ni. 3.19 ma Konohiki; Mem. 55 1/2° No. 2.00 ma Ke Ehu, i ke Kiki mua, Area, 0.47 o ka Eka.

Apana 3. ma Kawaihoa Kai, Aoomaka ma Ke Kahuahale Kiki; Ko. H. Holo. Ak. 58 1/2° Ni. 1.20 ma Kahuahale, Mem. 26° Ni. 2.71 ma Konohiki; Holo. Mem. 57° No. 3.49 ma Kihoe, Paalaa, Holo. Ak. 35 1/2° No. 3.47 ma Kihoe Paalaa, Ak. 52 1/2° Ni. 2.83 ma Konohiki i ke Kiki mua, Area, 0.99 o ka Eka.

Aprila 20, 1852

J. S. Emerson
Ma ana,

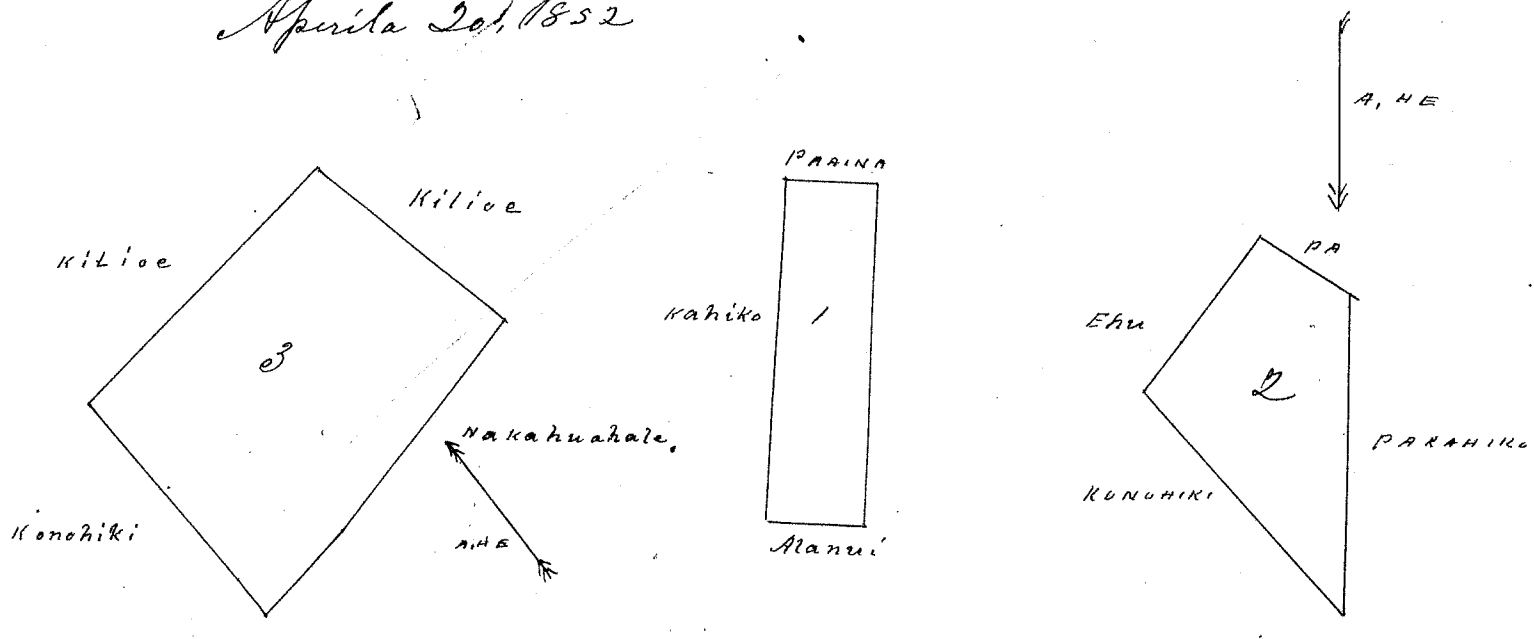

Wku Pau Loa # 5

W. H. Pease
G. M. Robertson
S. H. Smith
J. H. Kaulahao

Honolulu 14 Sep 1852,

Kulu 7583 Kei Kuleloa (Papaa Kawai

Maloko o ke Ahupuaa o Papaa, Ika Kawai;

Apana 1. Pahale, Penei na Mokuna, Chomaka ana ma ke alanui aupuni, ma Kahi pahu laau, alaila, Hem. 23° Ki. 1/2, 50/100 Kaul. e pili ana i ke Alanui Aupuni, Hem. 45° Ki. 2 Kaul. e pili ana i ke Kula Konohiki, Ak. 23° Ki. 1/2, 50/100 Kaul. e pili ana i ke Kula o Konohiki, Ak. 45° Ki. 2 Kaul. e pili ana i ke Kula Konohiki e ili ana 1 Ruda, 8 Perka.

Apana 2. Aina Kalo, Penei na Mokuna, Chomaka ana ma ke Kahawai o Papaa, ma Kahi pahu laau, alaila, Hem. 70° Ki. 2 80/100 Kaul. e pili ana i ke Kula o Konohiki, Hem. 12° Ki. 2 Kaul. e pili ana i ke Kula o Konohiki, Ak. 70° Ki. 3 50/100 Kaul. e pili ana i ke Kula Konohiki, Ak. 33° Ki. 2 Kaul. e pili ana i ke Kahawai, e ili ana 2 Ruda.

Apana 3. Aina Kalo, Penei na Mokuna, Chomaka ana ma ke Kula o Konohiki ma Kahi pahu laau, alaila aku, Ak. 8° Ki. 1/2 Kaul. e pili ana i ke Kula o Pali, Hem. 80° Ki. 2 60/100 Kaul. e pili ana i ke Muliwai o Papaa, Hem. 11° Ki. 3 45/100 Kaul. e pili ana i ke Kula o Konohiki, Hem. 88° Ki. 2 50/100 Kaul. e pili ana i ke Kula o Konohiki, e ili ana 3 Ruda, 30 Perka.

Kawai, Aug. 10, 1852

W. H. Pease,

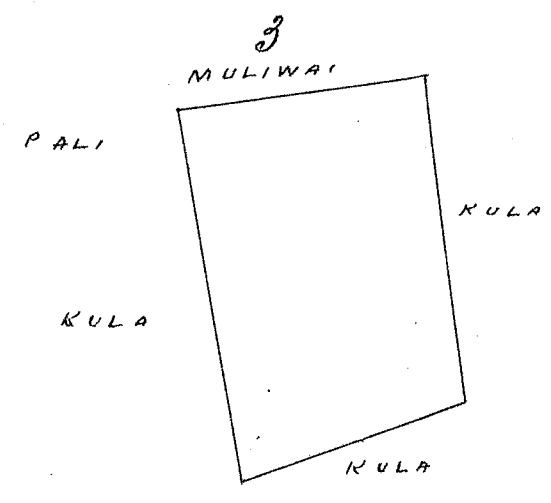
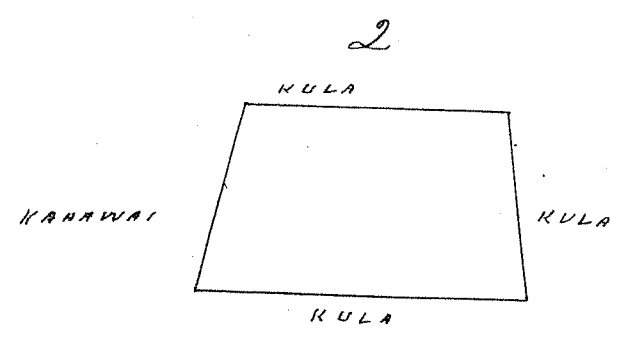
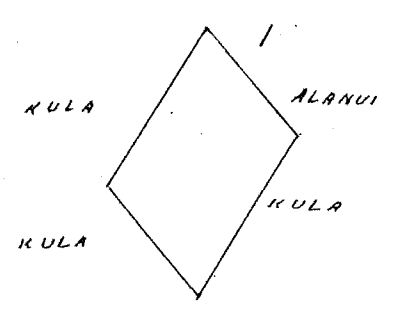

2 Kaul 1/2

Wm Pau Loa
W. H. Pease
G. M. Robertson
J. Kekaulahao
J. H. Smith

Honolulu 6 Sep 1852

Helu 5101 Kaula

Papaa Puna Hawaii

177

Maloko o ke Ahupuaa o Papaa Puna Hawaii

Apawa 1. Pahale, Penei na Mokuna, Chromaka ana ma ka Muliwai o Papaa ma ke Kapa Akau, ma Kahi pahu laau, AK. 32° Hi. 1.6/100 Kaul. e pili ana i ke Kula o Honohiki, Hem. 82° Hi. 1.6/100 Kaul. e pili ana i ke Kula o Honohiki, Hem. 11. Hi. 1.6/100 Kaul. e pili ana i ke Kai, AK. 82° Hi. 2.20/100 Kaul. e pili ana i ka Muliwai o Papaa, e ili ana 37 Perka.

Apawa 2. Chua Loi, Penei na Mokuna, Chromaka ana ma ka Kahawai o Papaa, ma ke Kahi Ke, Ke, o ma Loi o Paale, AK. 35° Hi. 2.50/100 Kaul. e pili ana i na Loi o Paale, Hem. 30° Hi. 1.6/100 Kaul. e pili ana i ka pali, Hem. 35° Hi. 2.20/100 Kaul. e pili ana i na Loi o Wi, AK. 39° Hi. 1.50/100 Kaul. e pili ana i ke Kahawai o Papaa, e ili ana 1 Ruda, 13 Perka.

Hawaii Aug 10, 1852

M. H. Pease

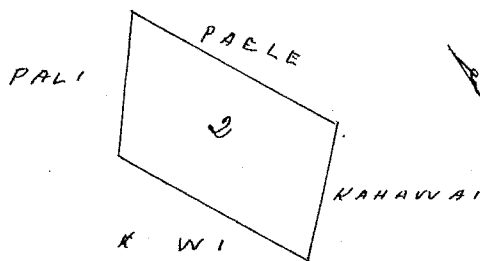
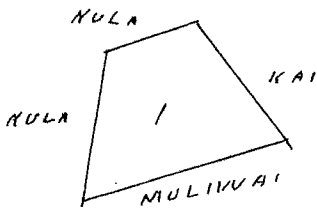

2 Kaul. 1 In.

Wku Pau Loa # 5

M. H. Pease
G. M. Robertson
J. Kekaulahou
J. H. Smith

Honolulu 6 Sep. 1852

Helu 5085 Kiaipa

Papaa Hawaii

Puna Kala Pahale me Kula, maloko o ke Ahupuaa o Papaa, Puna Hawaii, Penei na Mokuna, Chromaka ana ma Kahi pahu laau, ma ka pali me Kula, AK. 85° Hi. 4 Kaul. e pili ana i ke Kula o Honohiki, Hem. 6° Hi. 3.75/100 Kaul. e pili ana i ke Kahawai o Papaa, Hem. 85° Hi. 4.20/100 Kaul. e pili ana i ke Kula o Honohiki, AK. 2° Hi. 3 Kaul. e pili ana i ke Kula o Honohiki e ili ana 1 Eka 1 Ruda 22 Perka.

Hawaii Aug 10, 1852

M. H. Pease

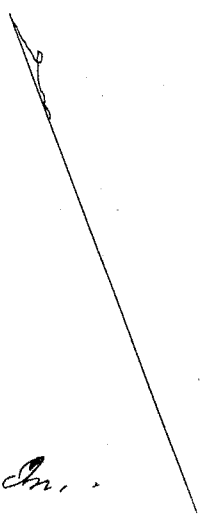

2 Kaul. 1 In.

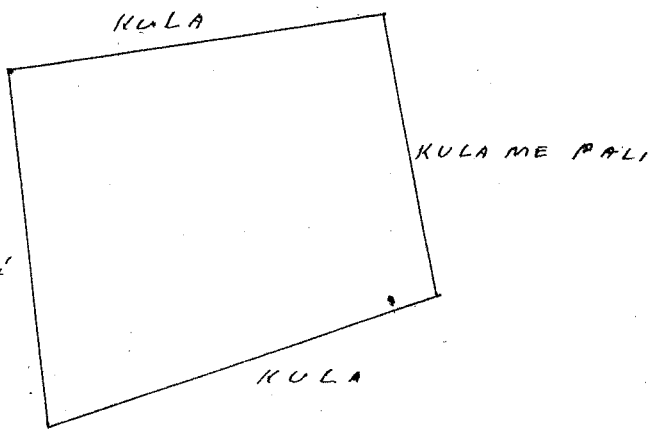

Wku Pau Loa # 6

M. H. Pease
G. M. Robertson
J. Kekaulahou
J. H. Smith

Honolulu 6 Sep. 1852

Helu 464. Pease

Papaa Hawaii

Malohe o ke Ahupuaa Papaa, Luma, Hawaii,

Apana 1. Aina Kalo "Kaikapa" Ka inua, Penei na Mokuna. E hoomaka ana ma ka Muliwai o Papaa, ma wa Ioi. Konoheki, alaila aku, Ak. 29° Ko. 2 Kaul. e pili ana i wa Ioi o Konoheki, Hem. 56° Ko. 2, 80/100 Kaul. e pili ana i ka pali; Hem. 35° Ki. 2, 50/100 Kaul. e pili ana i wa Ioi o Kalua, Ak. 45° Ki. 2, 60/100 Kaul. e pili ana i ke Kahawai o Papaa, e ili ana 2 Puda, 1 Perka

Apana 2. Pahle, Penei na Mokuna. E hoomaka ana ma ka Muliwai o Papaa, ma ke Kapa Hikina, ma ka pohaku, Hem. 14° Ki. 3 Kaul. e pili ana i ke Pula o Konoheki, Ak. 78° Ki. 2, 50/100 Kaul. e pili ana i ke Pula o Konoheki Ak. 15° Ko. 2, 72/100 Kaul. e pili ana i ke Kai, Ak. 85° Ko. 2, 60/100 Kaul. ma ke Muliwai o Papaa, e ili ana 3 Puda,

Hawaii Aug 5 1852

M. H. Pease

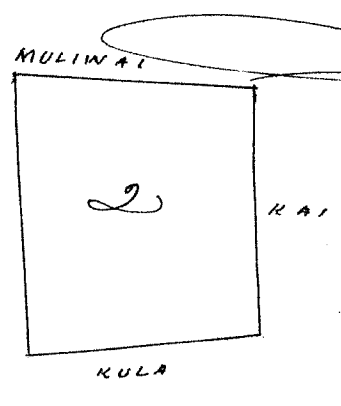
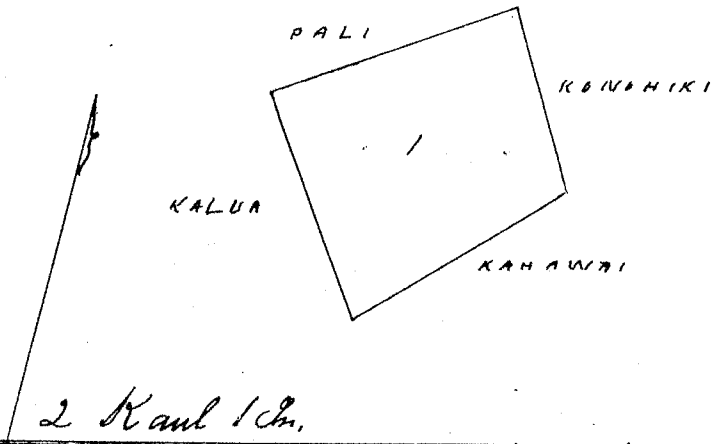

When Pan Gra 5

- M. H. Pease
- G. M. Robertson
- J. Hekaulahao
- J. H. Smith

Honolulu, 6 Sep 1852

Helu 4558. Pease

Papaa Hawaii

Malohe o ke Ahupuaa Papaa Koolan Hawaii,

Apana 1. Aina Kalo me Kula, malohe o ka ili o Mui. Penei na Mokuna E hoomaka ana ma ka pali, ma ke Kapa Hikina o ke Kahawai, Papaa, alaila aku, Ak. 51° Ki. 2, 50/100 Kaul. e pili ana ma ka pali me Kahawai Ak. 42° Ko. 4, 50/100 Kaul. e pili ana i ke Pula o Konoheki, Hem. 68° Ko. 2, 50/100 Kaul. e pili ana i ke Pula o Konoheki, Hem. 42° Ki. 4, 50/100 Kaul. e pili ana i ke Pula o Konoheki, e ili ana, 1 Eka,

Apana 2. Aina Kalo me Kula, Penei na Mokuna, E hoomaka ana ma ke Kahawai, Papaa, ma ke Kahi Ke. Ke, o wa Ioi o Kalua, alaila aku, Ak. 35° Ko. 2, 20/100 Kaul. e pili ana i wa Ioi o Kalua, Hem. 22° Ko. 3, 60/100 Kaul. e pili ana i ka pali; Ak. 60° Ki. 3, 50/100 Kaul. e pili ana i ke Kahawai o Papaa, e ili ana 1 Puda, 11 Perka,

Hawaii, Aug. 10, 1852

M. H. Pease

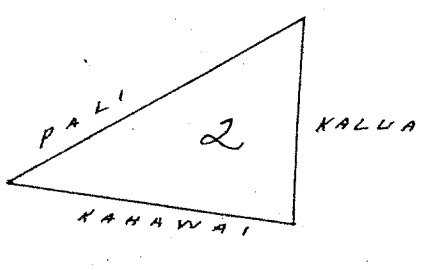
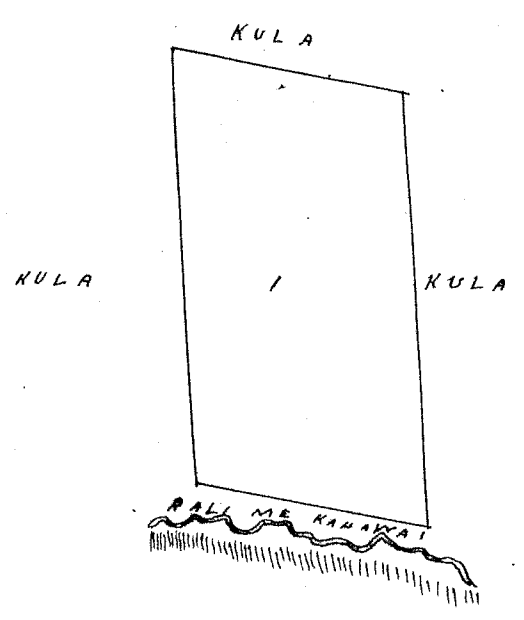

Wku Pau Ioa # 6.
W. Lee
G. M. Robertson
J. Kekaulaha
J. H. Smith

Honolulu 6 Sep. 1852.

~~Wku Pau Ioa # 6~~ Kealikianakaole 8933. (Halawa, Molokai)

Moo aina i loko o ka ili o Moaiki, Halawa, Molokai.
E hoomaka ana ma ke kahi Akau, e huli ana, Hem. 31 1/2, Hiki i 0.54, Kh. ma ka palena o Kaianni
Mabaita aku, Hem. 29, Hiki i 3.00 Kh, ma ka Kaianni, Mabaita aku, Hem. 77, Kom. i 46, Kh.
ma ka Kahawai, Mabaita aku, Ak. 25, Kom. i 283, Kh. ma ka Kahawai, Mabaita aku,
Hem. 77 1/2, Kom. i 0.59 Kh, Mabaita aku, Ak. 24, Kom. i 0.37, Kh, Mabaita aku, Ak. 63,
Hiki i 0.79, Kh. ma ke Koele, Hem. 1.25/100 Kh. huinaha,

Apana 2. Mau Loi i loko o Moaiki.
E hoomaka ana ma ke kahi Kikina, e huli ana, Hem. 50, Kom. i 0.55 Kh ma ke Koele, Mabaita
aku, Ak. 41, Kom. i 1.86 Kh, ma ka palena o Kahawai, Mabaita aku, Ak. 4 1/2, Hiki i 0.
23, Kh, Mabaita aku, Ak. 40, Kom. i 0.42, Kh, Mabaita aku, Ak. 47, Hiki i 0.56, Kh,
ma ke Koele, Mabaita aku, Hem. 34, Hiki i 2.50, Kh ma ka Kaianni, a ka hoomaka
ana, He. 1.63/100 Kh. huinaha,

Apana 3. Mau Loi me ke Kuba i Moaiki.
E hoomaka ana ma ke kahi Kikina, e huli ana, Hem. 48 1/2, Kom. i 0.60 Kh, ma ke Koele, Mabaita
aku, Ak. 38, Kom. i 0.65, Kh, ma ka Pahaa, Mabaita aku, Ak. 48, Hiki i 0.60 Kh, ma ke
Kuba, Mabaita aku, Hem. 38, Hiki i 0.65 Kh, ma ka Kahawai, a hiki i ka hoomaka ana
He 3.79/100 Kh. huinaha
Pau Ioa 6, 87/100 Kh. huinaha,

A. Bishop.
Mua ana,
3

6.87

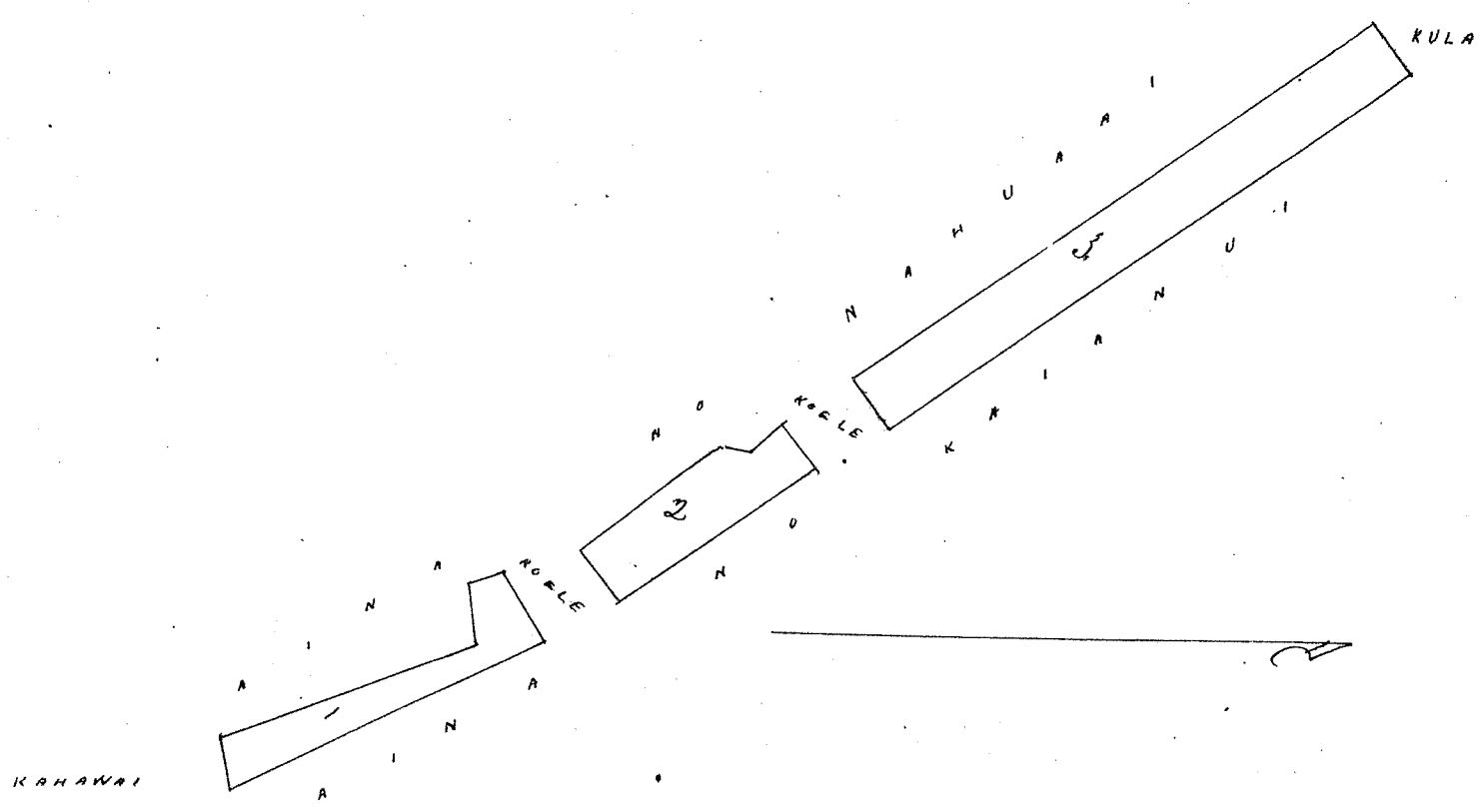

Wku Pau Ioa # 4.
W. L. Lee
G. M. Robertson
J. H. Smith
J. Kekaulaha

Honolulu, 15. Sep. 1852.

Holeu 10326 Paonealaa 55717 Halawa Molokai

Ke Mooina i loko. Opele, Halawa Molokai,
 E hoomaka ana ma ke Pahi Kama, i loko ana, Ak. 18° Kom. i 4.17, Kh. ma ka palena
 no Kamehe, Malaila aku, Ak. 1° Kom. i 2.24, Kh. ma ke Kamehe, Malaila aku,
 Ak. 29° Kom. i 6.00 Kh. Malaila aku, Ak. 10° Kom. i 2.24 Kh. Malaila aku,
 Ak. 27° Kom. i 2.24, Kh. Ma ka palena no Kamehe, Malaila aku, Ak. 44° Nih,
 i 3.36 Kh. ma Kahawai, Malaila aku, Kom. 30 1/2, Nih. i 1.73 Kh. ma ka pal-
 ena Koele, Malaila aku, Kom. 48 1/2, Kom. i 0.56 Kh. ma ke Kalawaianni, Malaila
 aku, Kom. 16 1/2, Nih. i 0.31, Kh. malaila aku, Kom. 58° Kom. i 0.43, Kh. Malaila
 aku, Kom. 23 1/2, Nih. i 1.58 Kh. ma ke Kalawaianni, Malaila aku, Kom. 3°
 Nih. i 0.60, Kh. Malaila aku, Ak. 87° Kom. i 0.41 Kh. ma ka palena Koele,
 Malaila aku, Kom. 2° Nih. i 0.60, Kh. Malaila aku, Kom. 88° Kom. i 0.61 Kh.
 Malaila aku, Akau, i 0.72 Kh. Malaila aku, Kom. 86° Kom. i 0.60 Kh. Malaila
 aku, Kom. 13 1/2, Nih. i 0.65 Kh. Malaila aku, Kom. 82° Nih. i 0.56, Kh. Malaila
 aku, Kom. 3° Kom. i 1.14 Kh. ma ke Koele, Malaila aku, Kom. 80 1/2, Nih. i 1.65
 Kh. ma ke Koele, Malaila aku, Ak. 69° Nih. i 1.90 Kh. ma ke Konoiki,
 Malaila aku, Kom. 45° Nih. i 1.83 Kh. Malaila aku, Kom. 14° Kom. i 1.70 Kh.
 Malaila aku, Kom. 23 1/2, Nih. i 7.13 Kh. ma ke Kula - Konoiki, Malaila aku,
 Kom. 89° Kom. i 2.90 Kh. ma ke Mumu pali, Malaila aku, Kom. 7 1/2 Kom. i
 3.35 Kh. ma ka pali, a hiki i ka hoomaka ana,
 Ke 4, 55 1/100 Eka,

A. Bishop.

Enana awao 567. 7. 7.

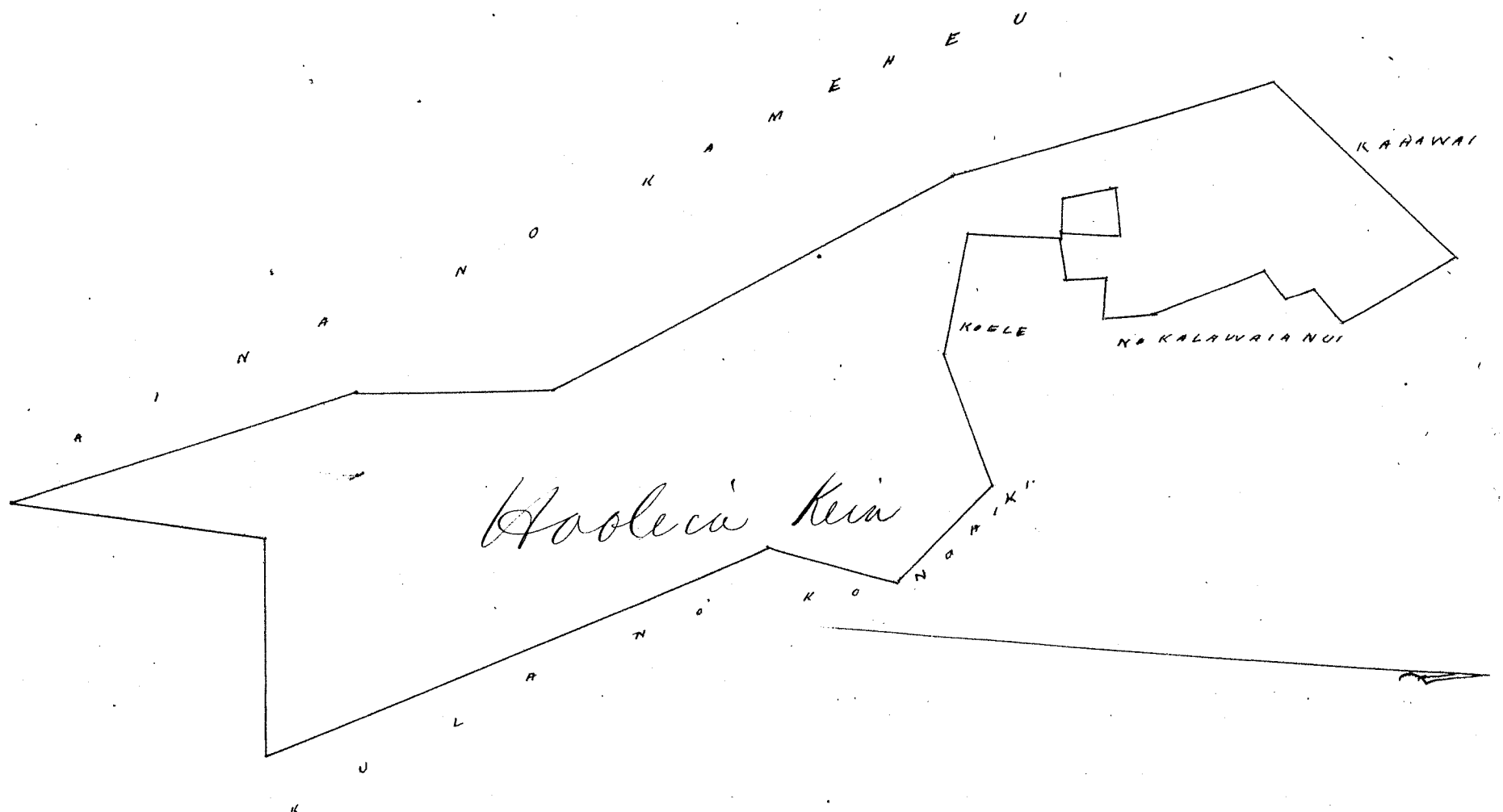

Wku Pau Loa # 6

G. M. Robertson

Honolulu, 15. Sep. 1852.

Hulu 6344 Koolauhea Kalawa Molokai

*He Mowaina i loko o Ke auhou, Kalawa, Molokai;
 E hoomaka ana ma ke Kihikau, i heli ana, Kom. 45° Kom: 5,50 Kh, ma Kula o Konohiki; Malaila aku, Kom. 54° H: i 6,40, Kh ma ke Upai; Malaila aku, Kom 62° Hiki: i 1,56 Kh, ma ke Upai; Malaila aku, Kom. 39° Hiki i 1,79 Kh. Malaila aku, Ak. 49° Hiki i 1,89 Kh, ma Kahawai; Malaila aku, Ak. 43° Kom: 0,90 Kh, ma ke Koele; Malaila aku, Ak. 38 1/2° Hiki: i 0,50 Kh, Malaila aku, Ak. 45° Kom 4,6 Kh. Malaila aku, Ak. 38° Hiki: i 0,48 Kh, ma ke Koele; Malaila aku, Ak. 37° Kom. 2,70 Kh ma ke Mahi; Malaila aku, Ak. 34° Kom i 5,90 Kh, Ma ke Mahi, a ka hoomaka ana, He 3 7/100 ma Eka.*

*Apana 2 He Kula i loko o Ke auhou,
 E hoomaka ana ma ke Kihikau, i heli ana, Kom. 55° Kom: 1,79 Kh ma Kahawai; Malaila aku, Kom. 112° Kom: i 1,44 Kh, ma Kahawai; Malaila aku, Kom 43° Hiki: i 2,30 Kh, ma ke Upai; Malaila aku, Ak. 41° Hiki: i 1,56 Kh, ma ke Kaahui; Malaila aku, Ak. 14° Hiki: i 1,56 Kh ma ke Konohiki; Malaila aku, Ak. 33° Kom. 2,00 Kh, malaila aku, a hiki: ka hoomaka ana, He 7 1/100 Kh, huinaha, Pauwa, 4 Eka, 54/100 Eka.*

*A. Bishop,
Mea ana,*

Comma arao 570.47

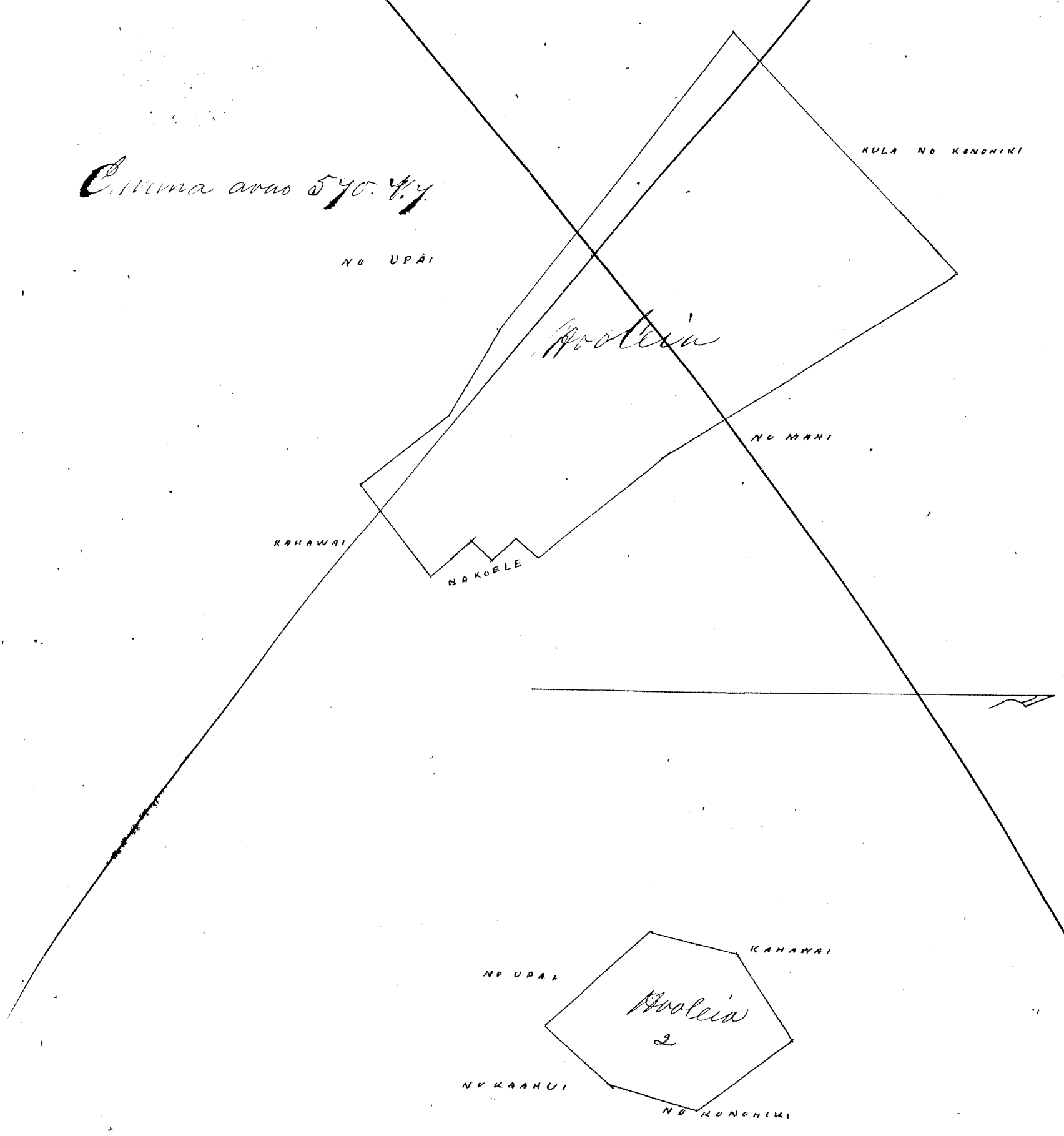

Ulu Pau Lou # 6

G. M. Robertson

Honolulu, 15, Sep. 1852

Hulu 285. Kowalo.

Kalawa Molokai

He Moovaina i loko o Keauhou, Kalawa Molokai.
E hoomaka ana ma ke Kihikihi, e huli ana, Ak. 18° Kom. i 3.58 Kh.
ma ka palena o Kalama, Mataila aku, Ak. 39° Kom i 5.50 Kh. ma
ke Kalama, Mataila aku, Kom. 63° Kom i 5.40 Kh. ma ka palena o Maki,
Mataila aku, Kom. 32° Hiki i 3.78 Kh. ma ke Akii, Mataila aku, Ak. 58°
Hiki i 0.73 Kh. a ka hoomaka ana, Ak. 7.97 per Kh. huimaha

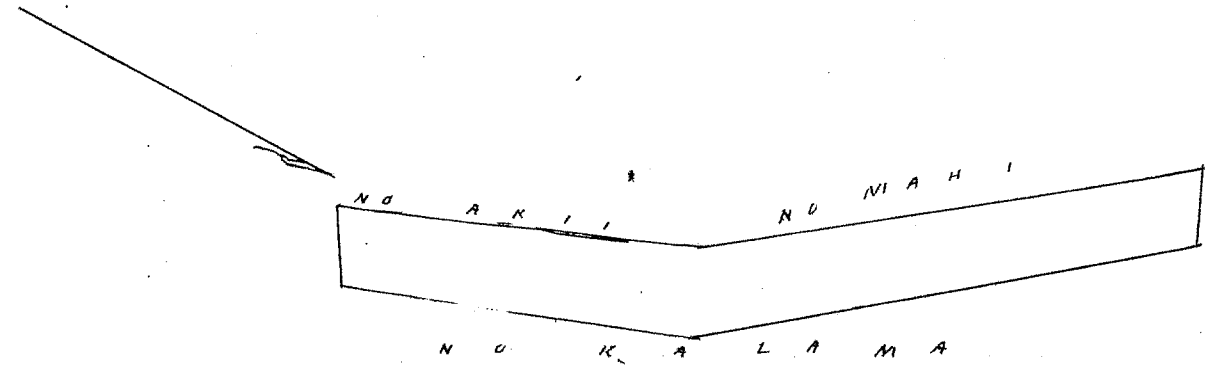

A. Bishop
Mea ana

Wm Pau Loa & Co.
W. L. Lee
G. M. Robertson
J. H. Smith
J. Kekaulaha

Honolulu 15 Sep 1852

Hulu 635. Naholowaa

Kalawa Molokai

He Moovaina i loko o Keauhou, Kalawa Molokai.
E hoomaka ana ma ke Kihikihi Akau, e huli ana, Kom. 43° Hiki i 7.25 Kh ma ka
palena o Haole, Mataila aku, Kom. 28° Hiki i 4.00 Kh. ma ke Haole, Mataila
aku, Kom. 50° Kom i 1.00 Kh. ma ke Kule, Mataila aku, Ak. 26 1/2° Kom i 3.90
Kh ma ke Kalama, Mataila aku, Ak. 39° Kom i 6.80 Kh. ma ke Kalama
Mataila aku, Ak. 39° Hiki 0.80 Kh. ma Kula, a ka hoomaka ana, 1 1/2 per Eka

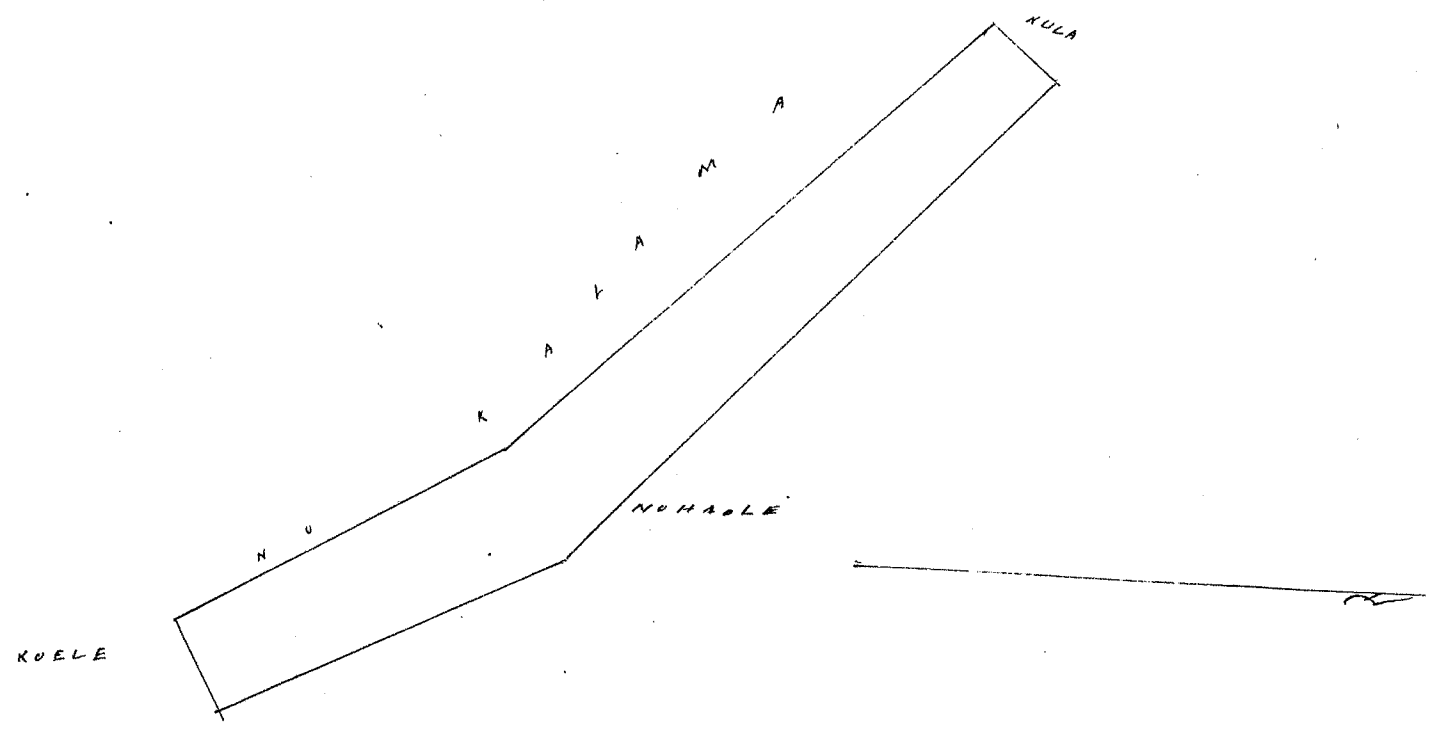

A. Bishop
Mea ana

Wm Pau Loa & Co.
W. L. Lee
G. M. Robertson
J. H. Smith
J. Kekaulaha

Honolulu, 15 Sep 1852

Keolu 8932 Kalamā

183
Halawa Molokai

Ke Mo'aina i loko o Ke auhou Halawa, Molokai,
E hoomaka ana ma Ke Kihikau, e huli ana, Hem. 35° Nih i 460 Kh, ma Ke
pa'una no Ke wala, Malaila aku, Hem. 28° Nih 323 Kh, ma Ke Ke wala, Malaila
aku, Ak. 70 1/2° Nih i 109 Kh ma Ke Koele, Malaila aku, Ak. 29° Hem i 248.
Kh, ma Ke Kaholowaa, Malaila aku, Hem. 72 1/2° Hem i 0.64 Kh, ma Ke
loi Kuuwa, Malaila aku, Ak. 9° Hem. i 0.46 Kh, Malaila aku, Ak. 72 1/2°
Nih i 0.63 Kh Malaila aku, Ak. 28° Hem. 0.48 Kh, Malaila aku, Ak. 40°
Hem. i 4.20 Kh, ma Ke Kaholowaa, Malaila aku, Ak. 60° Hem. i 0.90 Kh, a
hiki i Ke hoomaka ana, He 6, 7/100 Kh huihana.

A. Bishop
Hea ana

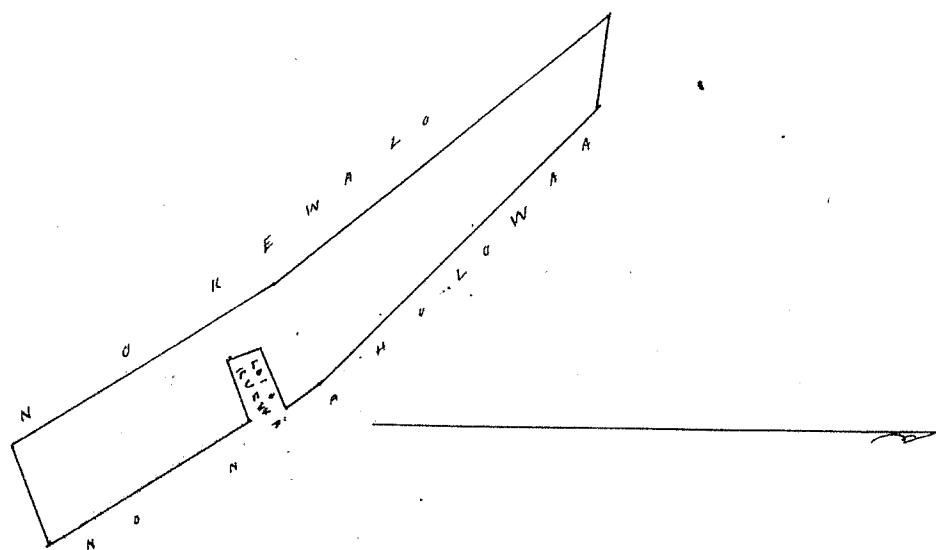

Wm Pau Loa & Co
W. L. Lee
G. M. Robertson
J. M. Smith
J. K. Kaulakoo

Honolulu 15 Sep 1852

Keolu 4541 Aarona

Halawa Molokai

Aarona make, Kahawanui Kooilua
Eli aina o Paupaa, Halawa Molokai, E hoomaka ma Ke Kihikau Hem. 35° e huli
ana, Ak. 22 1/2° Hem. i 1532 Kh, ma Ke pa'una o Kama'i, Malaila aku, Ak. 71°
Nih. i 189 Kh, ma Ke Koele Malaila, aku, Hem. 22° Nih. i 186 Kh, ma Ke Koele,
Malaila aku, Ak. 60° Nih. i 0.90 Kh, Malaila aku, Hem 28 1/2° Nih. i 290 Kh, ma
Ke Kainoetua Malaila aku, Hem 24 1/2° Nih. i 1190 Kh, ma Ke pa hale huli
Malaila aku, Hem. 87° Hem. i 3.50 Kh ma Ke Kula Kooilua, He 4, 9/100 Eka,

A. Bishop,
Hea ana,

Enomay awao 566.77.

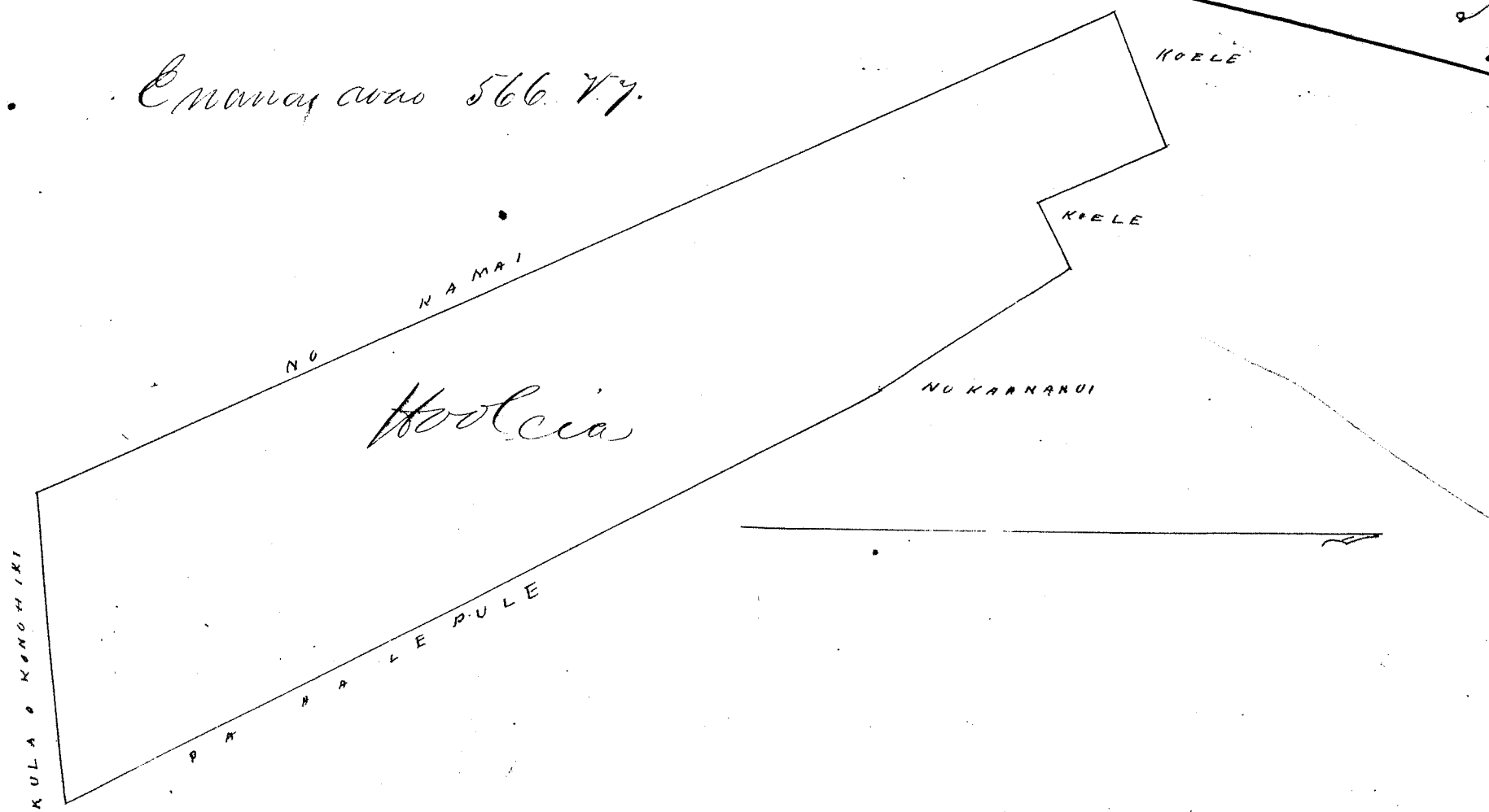

Helu 5012 Kōhānanui + 56847

Kōlawa Mōlōkai

Ka ihi aīna o Tininihi Kōlawa Mōlōkai;
 E hōmaka ana ma ke kīhi Kōhānanui, i hū ana, Ak. 20° Nih. i 4.67 Kh. ma ka pūle
 ma no Wāhineaea, Malaila aku, Ak. 22 1/2° Kom. i 9.74 Kh. malaila aku, Ak. 24°
 Nih. i 5.54 Kh. ma ke Wāhineaea, Malaila aku, Ak. 60° Nih. i 3.25 Kh. ma kula
 o Kōhōhiki, Malaila aku, Ak. 20° Kom. i 4.97 Kh. ma ke Kōhōhiki, Malaila
 aku, Ak. 45° Kom. i 1.46 Kh. Malaila aku, Ak. 57° Kom. i 1.44 Kh. ma ke Kōle,
 Malaila aku, Ak. 45° Nih. i 1.15 Kh. Malaila aku, Ak. 59 1/2° Kom. i 0.95 ma
 ke Kōle, Malaila aku, Ak. 43° Kom. i 1.00 Kh. Malaila aku, Ak. 50° Nih. i 0.84
 Kh. malaila aku, Ak. 38° Kom. i 1.16 Kh. Malaila aku, Ak. 70° Nih. i 1.16
 Kh. ma ke Kōle, Malaila aku, Ak. 21° Kom. i 2.89 Kh. ma ke Kōhōhiki,
 Malaila aku, Ak. 81° Kom. i 2.30 Kh. ma ke Kōhānanui, a ka hōmaka
 ana, He 2, 55/100 na Eka,

A. Bishop,
Mea ana,

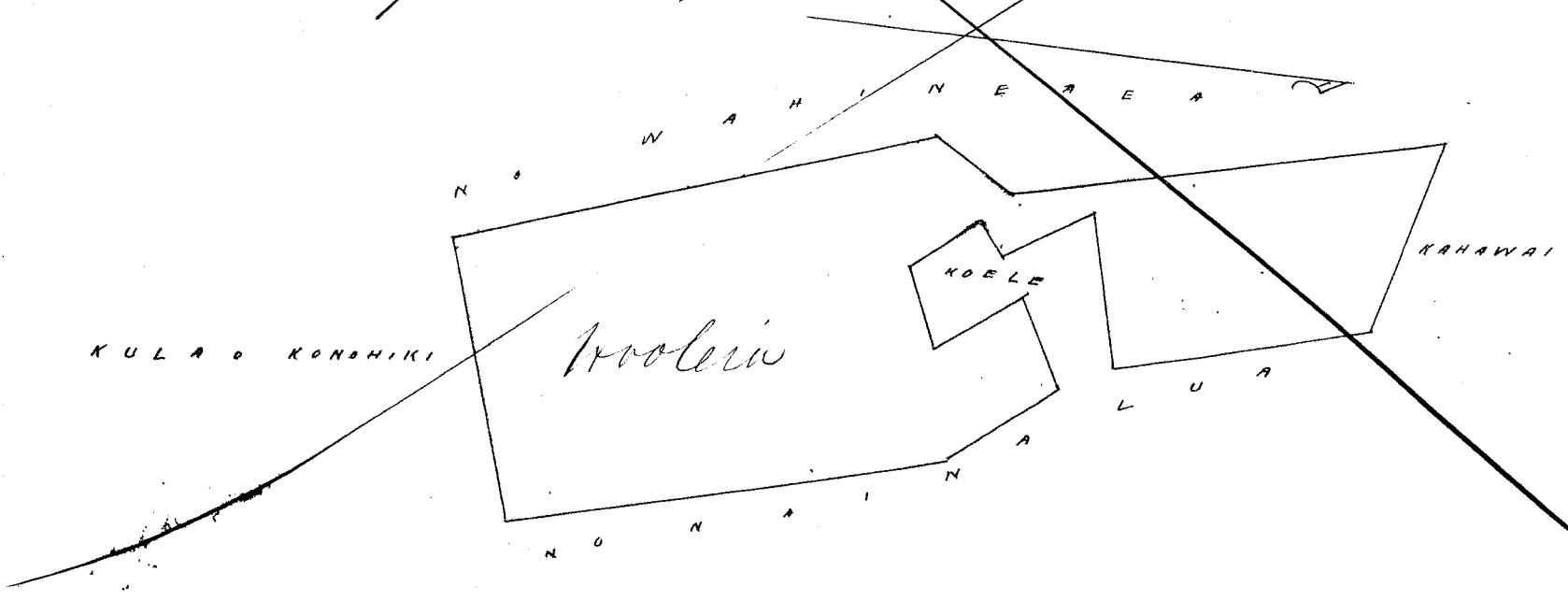

Maana 568.47

Wai Pau Loa # 5

G. M. Robertson

Honolulu 15 Sep 1852

Helu 6292 Kōwāhāhee

Kōlawa Mōlōkai

Ihi aīna o Kōwāhāhee 2, Kōlawa, Mōlōkai;
 E hōmaka ana ma ke kīhi Kōhōhiki, i hū ana, Ak. 36° Kom. i 2.00 Kh. ma
 ke Kōwāhāhee, Malaila aku, Ak. 50 1/2° Nih. i 0.16 Kh. Malaila aku, Ak. 41 1/2°
 Kom. i 3.08 Kh. Malaila aku, Ak. 46° Kom. i 2.00 Kh. ma ke Kōwāhāhee, Malaila
 aku, Ak. 50 1/2° Kom. i 0.90 Kh. a ka pūhaku malūna, Malaila aku, Ak. 46°
 Kom. i 2.00 Kh. ma ke Kōwāhāhee, Malaila aku, Ak. 63 1/2° Nih. i 7.40 Kh. ma ke
 Kōhōhiki, Malaila aku, Ak. 40 1/2° Nih. i 4.83 Kh. ma ke Kōwāhāhee o Wāhine
 aīna, Malaila aku, Ak. 44° Nih. i 0.17 Kh. malaila aku, Ak. 47° Nih. i
 2.00 Kh. Malaila aku, Ak. 54 1/2° Nih. i 12.2 Kh. a ka hōmaka ana;
 He 2 75/100 Eka,

A. Bishop
Mea ana,

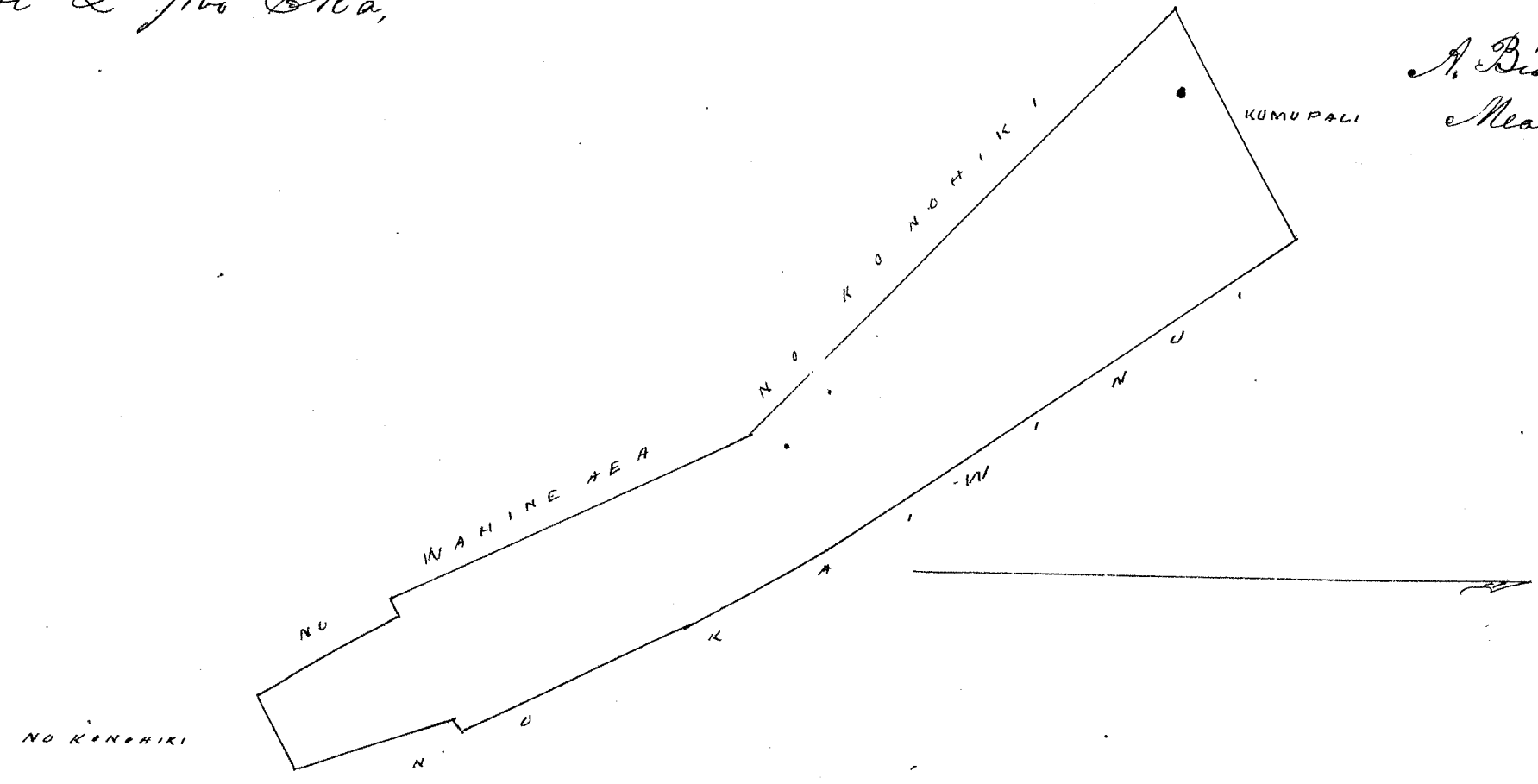

Wm Pau Loa #5.

W. L. Lee

G. M. Robertson

W. Smith

P. M. Kaulahas

Honolulu 15 Sep 1852.

Wells 4.716. Mahoe

Kalawa, Molokai

Ili aina o Loikahi, Kalawa, Molokai,
 E hoomaka ana ma ke Piki Akau, e huli ana, ~~hem. 88° N. i 8,00 Kh. ma Kula o~~
~~Konohiki, Malaila aku, hem. 88° N. i 8,28 Kh ma Kahawai, Malaila aku,~~
~~AK. 5° N. i 0,32 Kh, Malaila aku, AK. 78° N. i 1,36 Kh, ma ke Kote,~~
~~Malaila aku, AK. 14° N. i 0,50 Kh, Malaila aku, AK. 70° N. i 0,43 Kh,~~
~~Malaila aku, AK. 4° N. i 0,42 Kh, Malaila aku, hem. 83° N. i 0,50 Kh,~~
~~ma ke Kote, Malaila aku, AK. 13° N. i 2,44 Kh, ma ke Kula o Konohiki~~
~~Malaila aku, AK. 59° N. i 3,80 Kh, ma Kula o Konohiki a ka hoomaka ana~~
 He 2 ¹⁹/₁₀₀ Eka.

A. Bishop
Mea ana

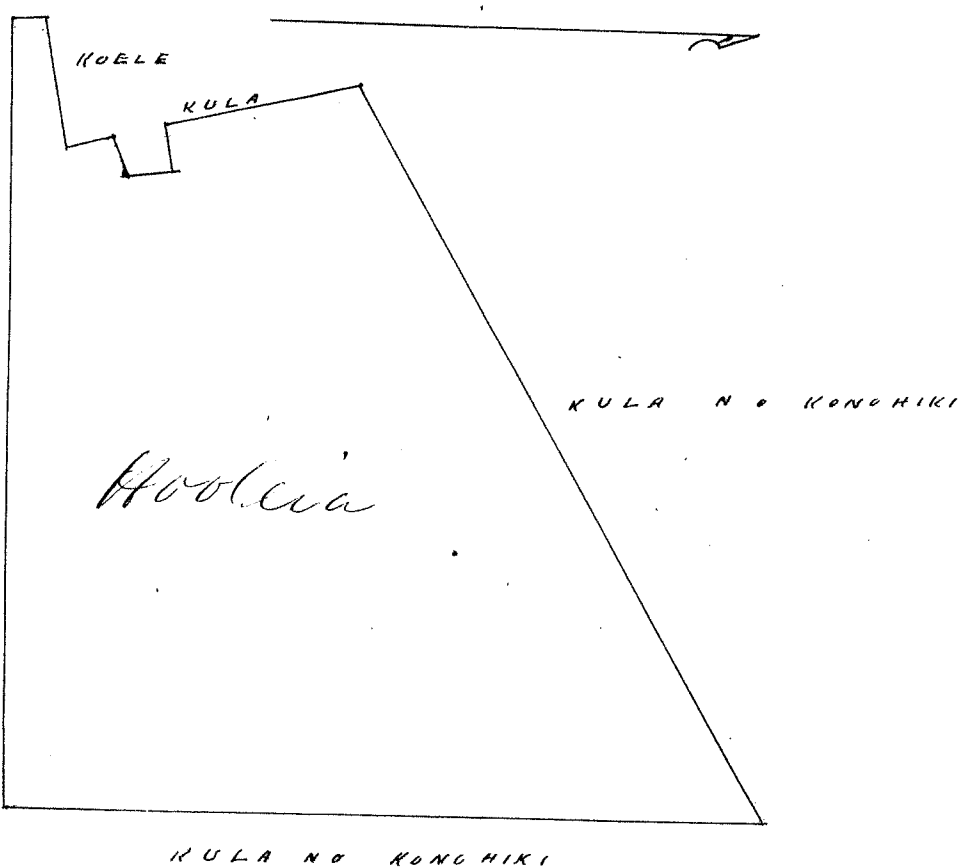

Enana 569 7/7

Wm Pau Loa #6

G. M. Robertson

Honolulu 15 Sep 1852.

Wells 10.939 Uu

Kalawa, Molokai

Uu. wa make, E hua hoilina aumeume, 1 o Kalua Kaitamahine 2 o Nana.
 Ili
 He Mooina i loko o Kamoku, Kalawa Molokai, E hoomaka ana ma ke Piki
 Akau, e huli ana, hem. 53° N. i 0,82 Kh, ma ke Kote, Malaila aku, hem. 37° N. i
 0,40 Kh, Malaila aku, hem. 54 1/2° N. i 0,47 Kh, ma ke Kote, Malaila aku,
 hem. 39° N. i 2,46 Kh, ma ka palena o Wahineaea, Malaila aku, AK. 20°
 N. i 1,00 Kh, ma Kahawai, Malaila aku, AK. 31° N. i 2,40 Kh, ma ke Upai,
 a hiki i ka hoomaka ana, He 2 ³⁶/₁₀₀ Kh, huihana,

A. Bishop,
Mea ana,

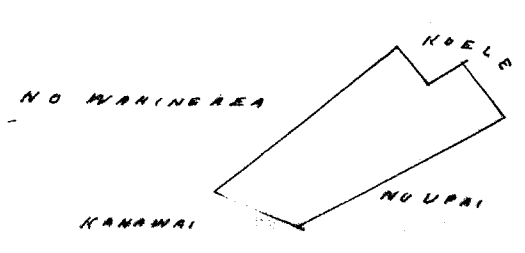

Uku Pau Loa #4
W. L. Lu

G. M. Robertson
J. H. Smith
J. Kekaulahao

Honolulu 15 Sep 1852

Hulu 5192 Kaulaau 1857 Halawa Molokai

~~Mooaina i loko o Kupuheua i Halawa Molokai.
E hoomaka ana ma ke Pihikiki Hikinana, e huli ana, Hem. 24. Kom i 4.64 Akh,
ma ka palena mo Pelelu, Malaila aku, Akh. 54 1/2; Kom i 2.50 Akh, ma ka
palena mo Kapahi, Malaila aku, Akh. 82 1/2; Kom i 1.63 Akh. Malaila aku
Hem. 43. Kom i 1.61 Akh. Malaila aku, Hem. 69. Kom i 2.94 Akh, ma ke
Kapahi, Malaila aku, Akh. 10. Kom i 1.19 Akh, ma ke Kauhale, Mal-
aila aku, Akh. 85. Hiki i 2.38 Akh, ma ka palena Kolu, Malaila aku,
Akh. 5. Kom i 0.80 Akh. Malaila aku, Hem. 89. Kom i 2.51 Akh. Malai-
la aku, Akh. 6 1/2 Kom i 4.42 Akh, ma ke Kauhale, Malaila aku,
Hem. 83. Hiki i 9.70 Akh, ma Pula o Konoiki, a ka hoomaka ana,
ke 2 ma Eka Maloko~~

A. Bishop.
Mea ana.

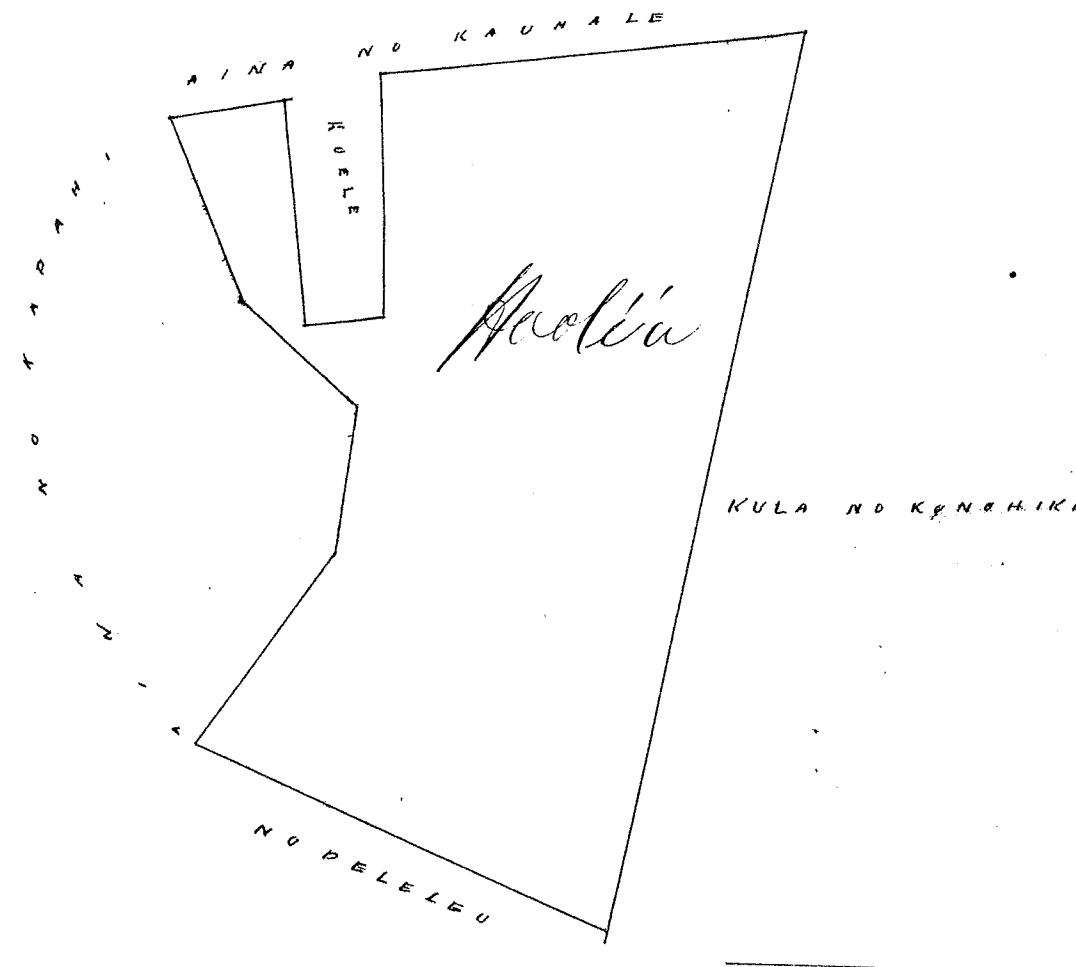

566.77
Enona avao 186.77

Uku Pau Loa #5

G. M. Robertson

Honolulu 15 Sep 1852

Hulu 4901 Kawaiipalava 572 17 Halawa Molokai

~~Apana 1. Ii aina o Kihio, i Halawa Molokai.
E hoomaka ana ma ke Pihikiki Hikinana, e huli ana, Akh. 55. Kom i 3.35.
Akh, ma ka palena Kolu, Malaila aku, Hem. 74. Kom i 4.50 Akh, ma ka
pali, Malaila aku, Hem. 70. Hiki i 1.39 Akh, ma ka palena o Kihio 2, Mal-
aila aku, Akh. 27 1/2; Hiki i 3.75 Akh ma Kauhale, a hiki i ka hoomaka ana,
ke 6 83/100 Akh, huihana,~~

~~Apana 2. Ii Kula Mahi i loko o Kapana.
E hoomaka ana ma ke Pihikiki Akh. Konoehana, e huli ana, Akh. 89. Hiki i 4.90 Akh
ma Pula o Konoiki, Malaila aku, Hem. 3. Hiki i 1.00 Akh, ma ka palena, Mal-
aila aku, Hem. 83 1/2 Kom. 3.97 Akh, ma ke alanui, Malaila aku, Hem. 54.~~

~~Komi 200 Kh. ma Kula, Malaila aku, Ak. 16, Niki: 272 Kh. a hiki i ka hoo-
maka ana, He. 6, 13/100 Kh. huihana,
Pau loa, 129/100 Eka,~~

A. Bishop,
Mea ana,

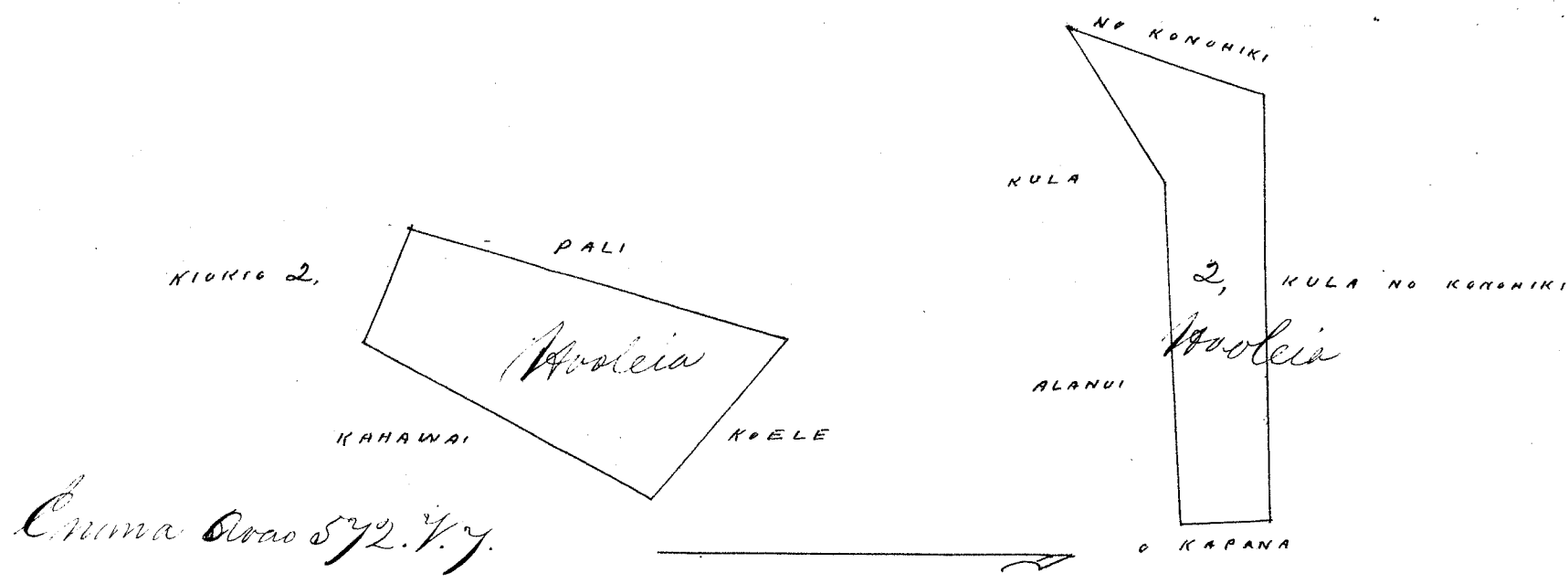

Uku Pau Loa 1/4

G. M. Robertson

Honolulu 15 Sep 1852

Hulu 500 Kookina

Kalawa, Molokai

Ipi aina o Mamiania Kalawa Molokai,
E hoomaka ana, ma ke Kahi Akau, e hule ana, Hem. 11 1/2 Niki: 2,00 Kh. Malaila
aku, Hem. 3 1/2, Niki: 3,00 Kh. Malaila aku, Hem. 8,00 Niki: 1,30 Kh. ma ka
paaluna no Kahale, Malaila aku, Hem. 7 1/2, Kom: 083 Kh ma Kahawai,
Malaila aku, Ak. 8 Kom. 0,52 Kh. ma ke Koele, Malaila aku, Hem 81 Kom
i 100 Kh. Malaila aku, Hem. 6, Niki: i, 0,73 Kh. Malaila aku, Hem 73 1/2 Kom i
1,70 Kh. Malaila aku, Ak. 5, Kom: 200 Kh, ma ka paaluna no Lupua,
Malaila aku, Ak. 2, Niki: 4,75 Kh. ma ke Lupua, Malaila aku, Ak 75
Niki: 2,70 Kh. a hiki i ka hoomaka ana, He 148/100 Eka,

A. Bishop,
Mea ana,

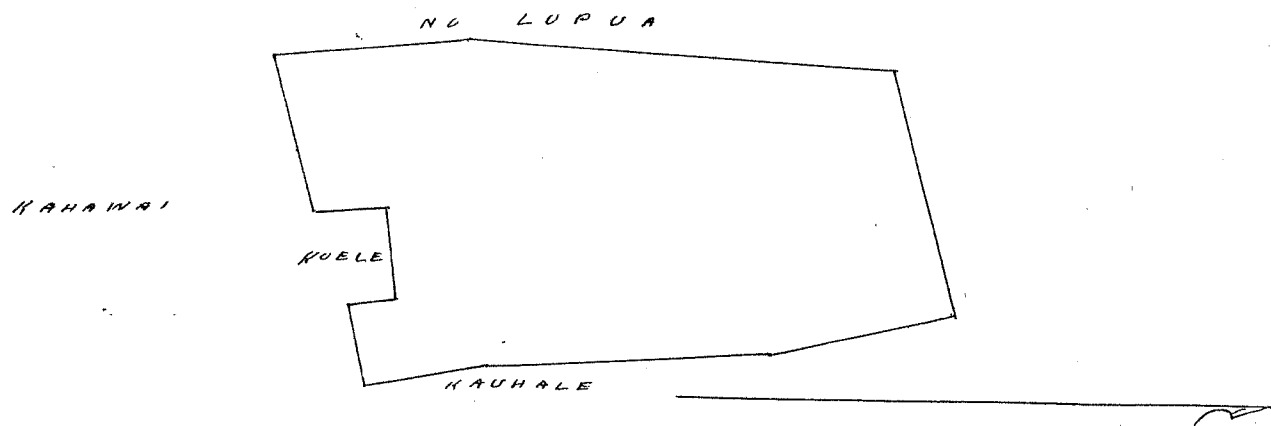

Uku Pau Loa 1/4

M. L. Lee
G. M. Robertson
J. H. Smith
J. Kikaulaoo

Honolulu 15 Sep 1852

Hulu 563 Tuana

Kalawa Molokai

Moraina i loko. Keauhau, Kalawa Molokai,
 E hoomaka ma ke kahi kama, e hulu ana, Ak. 61° Nih. i 0.99 Kh. ma ke Konohiki, Malaila
 aku, Ak. 35° Kom. i 2.10 Kh ma ke palena no Naelemakule, Malaila aku, Ak. 18°
 Kom. i 3.70 Kh. ma ke Naelemakule, Malaila aku, Ak. 37° Kom. i 1.32 Kh. Malaila
 aku, Kom. 58° Kom. i 1.00 Kh. ma Kula. Konohiki; Malaila aku, Kom. 35° Ak. i
 1.50 ma ke palena no Opulua, Malaila, aku, Kom 79 1/2° Nih. i 0.65 Kh. Malaila
 aku, Kom. 16° Nih. 2.94 Kh. ma ke Opulua, Malaila aku, Kom. 36° Nih. i 2.19 Kh.
 a ka hoomaka ana, ke 4 55/100 Kh huinaha

Apana 2, Ke Kula i loko. Keauhau
 E hoomaka ma ke kahi Komohana, e hulu ana, Ak. 58 1/2° Nih. i 1.55 Kh. ma ke Konohiki,
 Malaila aku, Kom. 35° Nih. i 3.53 Kh. ma ke Konohiki; Malaila aku,
 Kom. 78° Kom. i 0.47 Kh. Malaila aku, Ak. 53° Kom. i 3.60 Kh. ma Kahawai,
 ke 3 22/100 Kh huinaha, Pau loa, 7.77/100 Kh huinaha

A. Bishop
 Mea ana.

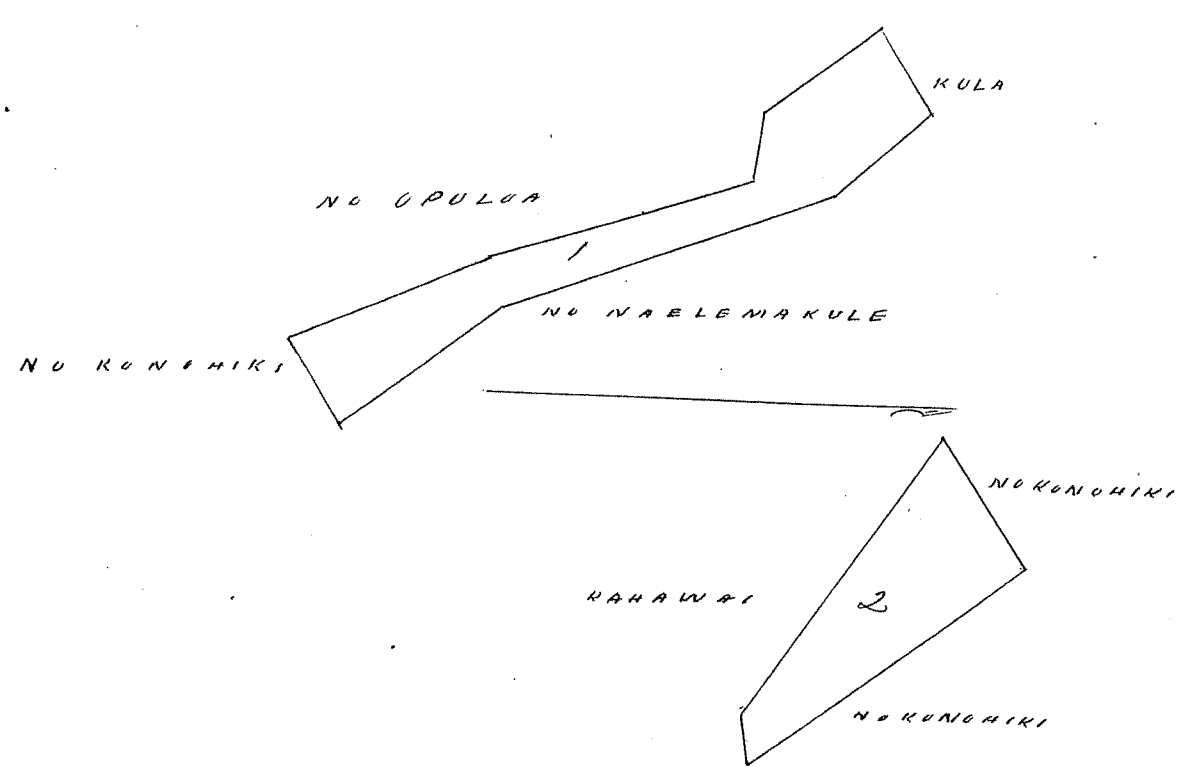

Wku Pau Loa \$4
 W. L. Lee
 G. M. Robertson
 J. H. Smith
 J. Kekaulahao

Honolulu 15. Sep. 1852.

Hulu 504 B. Akii

Kalawa Molokai

Apana 1. Mo i loko. Kahi Kalawa Molokai,
 E hoomaka ma ke kahi kama, e hulu ana, Ak. 64° Nih. 0.60 Kh. ma ke palena
 Kooli, Malaila aku, Ak. 19 1/2° Kom. 2.88 Kh. ma ke Kaniiau, Malaila aku
 Ak. 37° Kom. i 1.08 Kh. Malaila aku, Ak. 25° Kom. i 1.31 Kh. ma ke Kaniiau
 Malaila aku, Ak. 46° Nih. 0.26 Kh. Malaila aku, Ak. 26 1/2° Kom. i
 1.30 Kh. Malaila aku, Kom. 59° Kom. i 0.93 Kh. ma ke pa aina, Malaila
 aku, Kom. 28 1/2° Nih. i 4.59 Kh. ma ke Puana, Malaila aku, Kom. 67 1/2°
 Kom. i 0.60 Kh ma ke Kooli, Malaila aku, Kom 28 1/2° Nih. 4.98 Kh. ma ke
 Puana, a ka hoomaka ana, ke 7 66/100 Kh. huinaha.

A. Bishop
 Mea ana

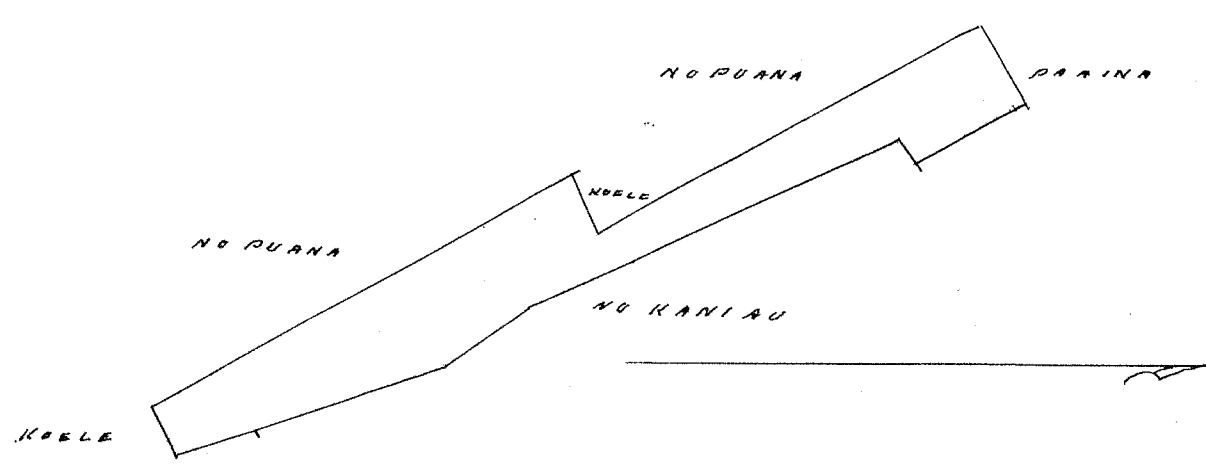

Uku Pau Loa # 4
W. L. Lee
G. M. Robertson
J. H. Smith

Honolulu 15 Sep 1852,
Kolu 6672 Mook + 57177 Halawa Molokai

Apawa 1. Ke Moo aina i loko o Kii, Halawa, Molokai,
E hoomaka ana ke Kii Aka, e hulu ana, Ak. 7° Niki i 100 Kh. ma ka palena Kou,
Mataila aku, Ak. 32 1/2° Niki i 100 Kh. ma ke Peleleu, Mataila aku, Ak. 37°
Niki i 2 1/4 Kh. ma ke Peleleu, Mataila aku, Ak. 35 1/2° Niki i 2 1/3 Kh. Mataila
aku, Ak. 54° Niki i 0,76 Kh. ma Kula o Konehiki; Mataila aku, Ak. 23 1/2° Kom i
500 Kh. ma ka palena no Kaahu; Mataila aku, Ak. 26 1/2° Kom i 100 Kh.
Mataila aku, Ak. 35° Kom i 118 Kh. ma ke Kaahu; Mataila aku, Ak. 26°
Kom i 100 Kh. Mataila aku, Ak. 32° Kom i 0,86 Kh. ma ka palena Kou, a
hiki i ka hoomaka ana, Ke 3 1/100 Kh. huinaha

Apawa 2, Ke Moo i loko o Kaopa Halawa,
E hoomaka ana ma ke Kii Aka, e hulu ana, Ak. 55° Niki i 1,190 Kh ma Kula
o Konehiki; Mataila aku, Ak. 29 1/2° Kom i 100 Kh. ma ka palena no Kaahu
Mataila aku, Ak. 57° Kom i 0,94 Kh. Mataila aku, Ak. 29° Kom i 1,23 Kh.
ma ke Kaahu, Mataila aku, Ak. 68° Kom i 0,90 Kh. ma ke Kou, Mataila
aku, Ak. 26° Niki i 2,50 Kh. a hiki i ka hoomaka ana, Ke 3 1/100 Kh. huinaha,

Apawa 3, Ke Kula i loko o Kaopa,
E hoomaka ma ke Kii Aka, e hulu ana, Ak. 22 1/2° Kom i 10,00 Kh. ma ka palena
no Kahanana, Mataila aku, Ak. 73° Niki i 1,90 Kh. ma ka palena Kou,
Mataila aku, Ak. 20° Niki i 9,68 Kh. ma Kula no Kaahu, Mataila aku,
Ak. 60° Kom i 2,78 Kh. ma ka pali, Ke 1,63/100 Eka, Pau Loa, 2 25/100 ma Eka,

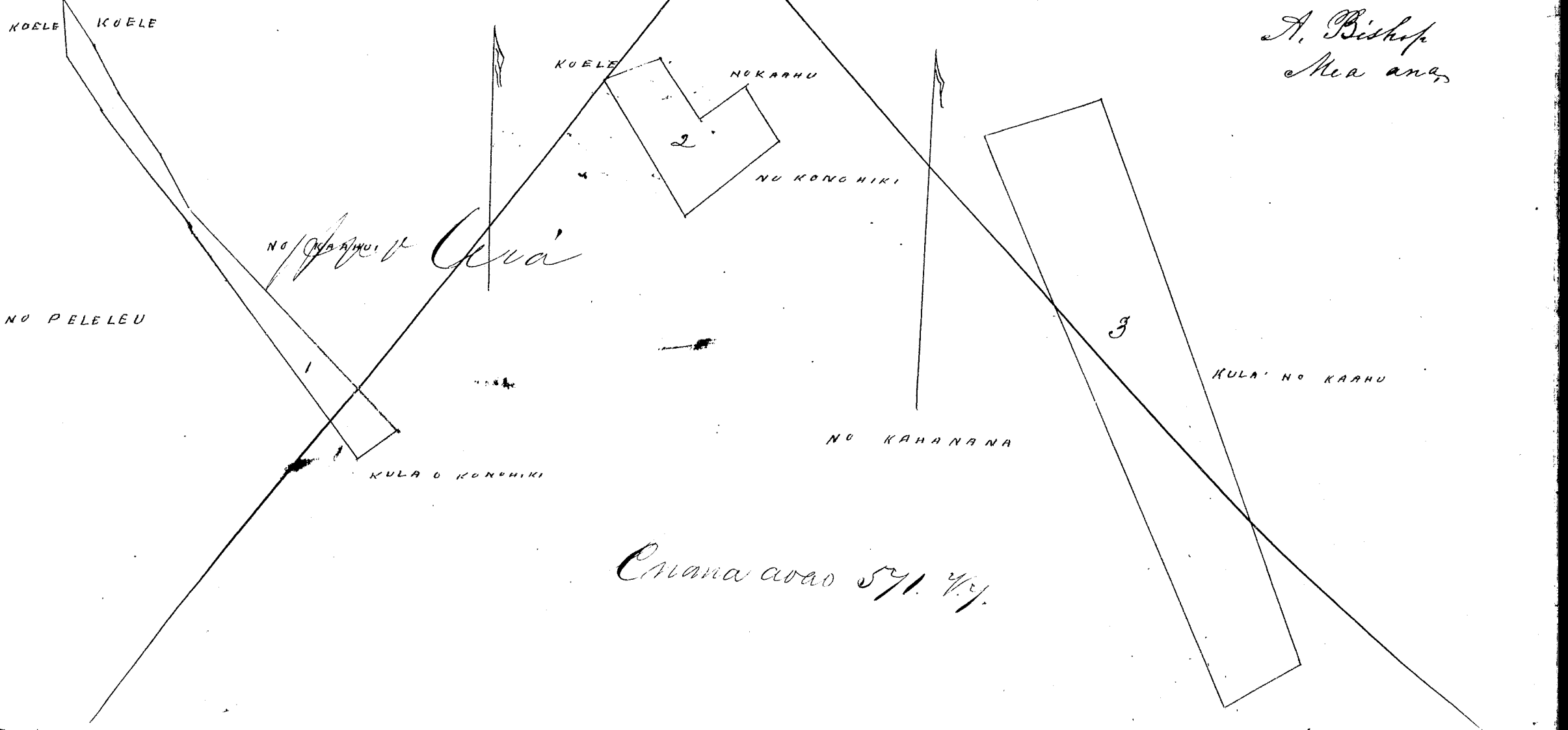

Uku Pau Loa # 5
G. M. Robertson

Honolulu, Oahu, 15 Sep, 1852.

Keolu 10573 Oioi + Halawa Molokai

Ili aina Puaalaulau, I. Halawa, Molokai.
E hoomaka ma ke kiki Akau, e hili ana, hem. 14.° hiki i 197 Kh. ma ka palena.
Puaalaulau I. Malaila aku, hem. 5 1/2°, hiki i 510 Kh. Malaila aku, hem. 55°
Kom i 120, Kh. ma ka pali, Malaila aku, Ak. 32° Kom i 750 Kh. ma Aulo
no Konoehiki, Malaila aku, Ak. 12°, hiki i 100 Kh. ma ke Kapana, Malaila
aku, Ak. 70 1/2°, hiki i 648 Kh. ma ke Kula o Konoehiki, a hiki i ka hoomaka
ana, ke Li 1/100 Eka.

A. Bishop
Ma ana

Aole hookomo kuleana i keia
apana aina mamua, no
J. Keawaiwi mai i ka M.H.
1850. ke kuleana e ae
Kona ma 'Moaniki' KULA NO KONOHIKI
I. Kekaulahao

Aole pono keia

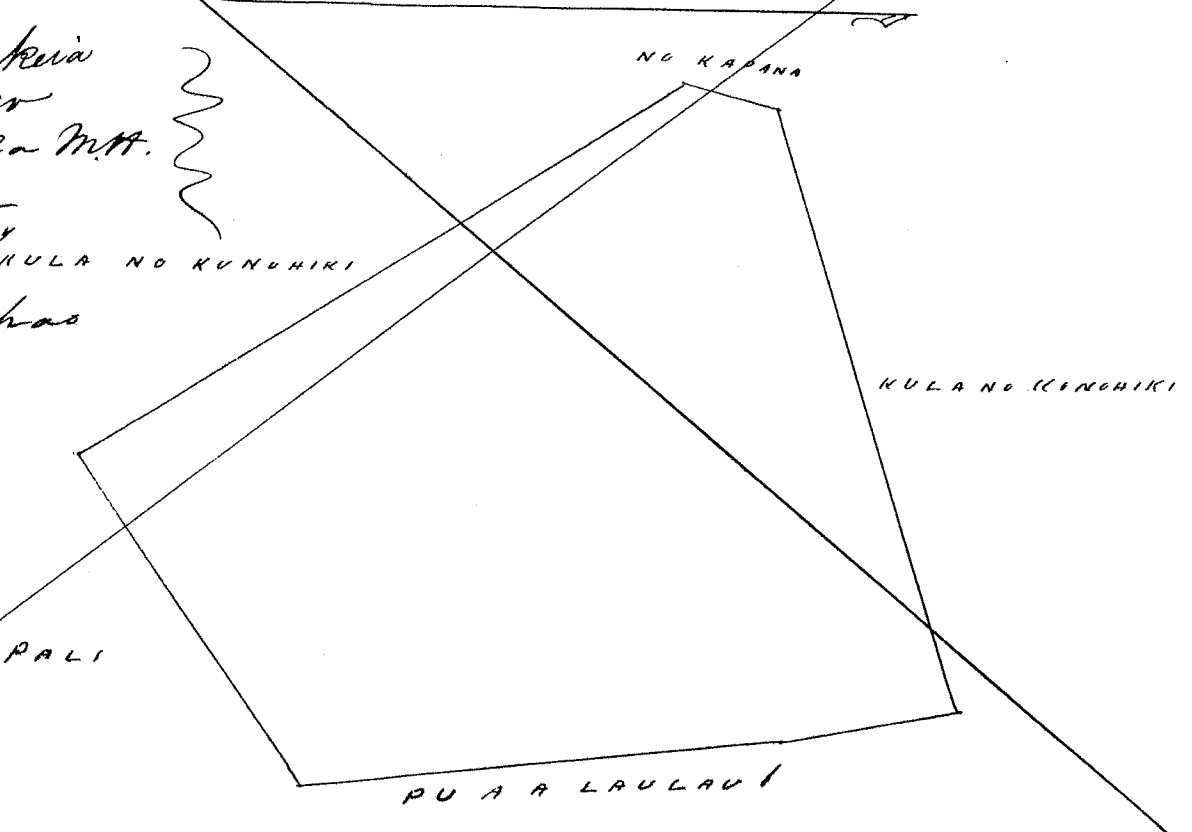

W. L. Lee
G. M. Robertson
J. H. Smith
I. Kekaulahao

Honolulu 15 Sep 1852

Keolu 8930 Keoluau Mahinealii, o Kooitina Halawa Molokai.

Apapa I. Moa aina i loko o Kohopapala, Halawa, Molokai.
E hoomaka ma ke kiki Akau, e hili ana, hem. 2.° Kom i 0.25 Kh. Malaila aku,
hem. 88 1/2° hiki i 0.48 Kh. Ma ka palena no Kahawai, Malaila aku, hem. 8° Kom i 167 Kh.
ma ke Kahawai, Malaila aku, Ak. 63° Kom i 136 Kh. ma ke Konoehiki, Malaila aku,
hem. 61° Kom i 0.52 Kh. Malaila aku, hem. 20 1/2°, hiki i 0.20 Kh. Malaila aku, hem. 57°
Kom i 0.47 Kh. Malaila aku, Ak. 34° Kom i 0.52 Kh. ma ke Kahawai, Malaila
aku, Ak. 16° Kom i 110 Kh. Malaila aku, hem. 85 1/2° hiki i 280 Kh. A hiki i
ka hoomaka ana, ke Li 74/100 Kh huinaha

Apapa I. Ili aina Kohopapala, Halawa.
E hoomaka ma ke kiki Akau, e hili ana, hem. 70° hiki i 180 Kh. Malaila aku,
hem. 47° hiki i 110 Kh. ma ka palena no Kahawai, Malaila aku, hem. 28°
hiki i 0.64 Kh. Malaila aku, hem. 42 1/2° Kom i 211 Kh. ma Kahawai Mal-
aila aku, hem. 20° Kom i 220 Kh. ma Kahawai, Malaila aku, Ak. 25°
Kom i 0.21 Kh. Malaila aku, hem. 56° Kom i 0.65 Kh. ma ke Kula, Malaila aku,
hem. 39° hiki i 0.25 Kh. Malaila aku, hem. 33° Kom i 0.91 Kh. ma Kahawai,
Malaila aku, Ak. 26° Kom i 110 Kh. ma Konoehiki, Malaila aku, hem. 36° Kom i
0.60 Kh. Malaila aku, hem. 38° hiki i 100 Kh. Malaila aku, hem. 41° Kom i
215 Kh. ma Kahawai, Malaila aku, hem. 75 1/2° Kom i 0.48 Kh. Malaila
aku, Ak. 25° Kom i 310 Kh. ma ka palena no Kiritua Malaila aku,
Ak. 35° Kom i 2.21 Kh. Malaila aku, Ak. 56° hiki i 500 Kh. ma ke
alauhi, Malaila aku, Ak. 73° hiki i 228 Kh. ma ke ala, a hiki i ka hiki
i hoomaka i, ke Li 36/100 ma Eka. Pau loa 4 1/100 ma Eka.

A. Bishop
Mea ana.

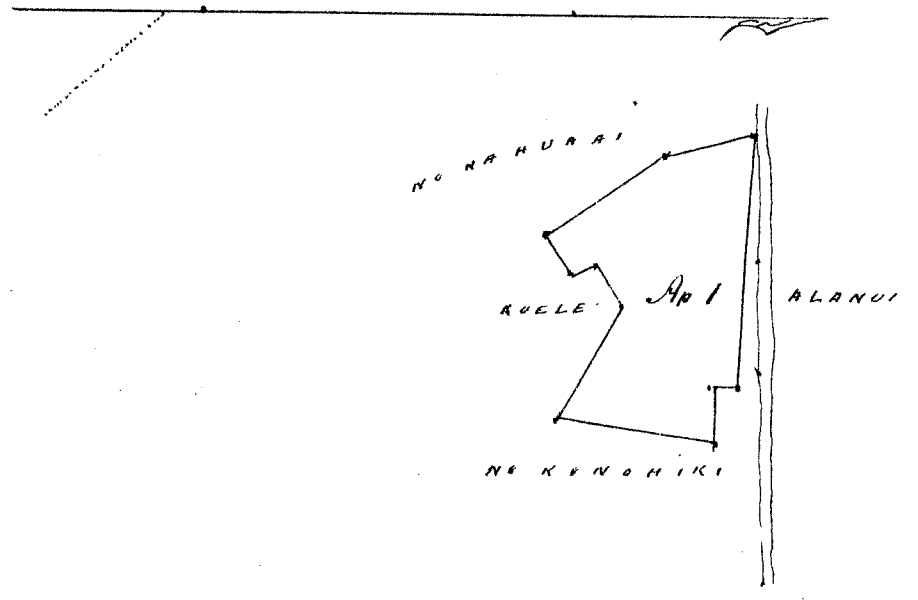
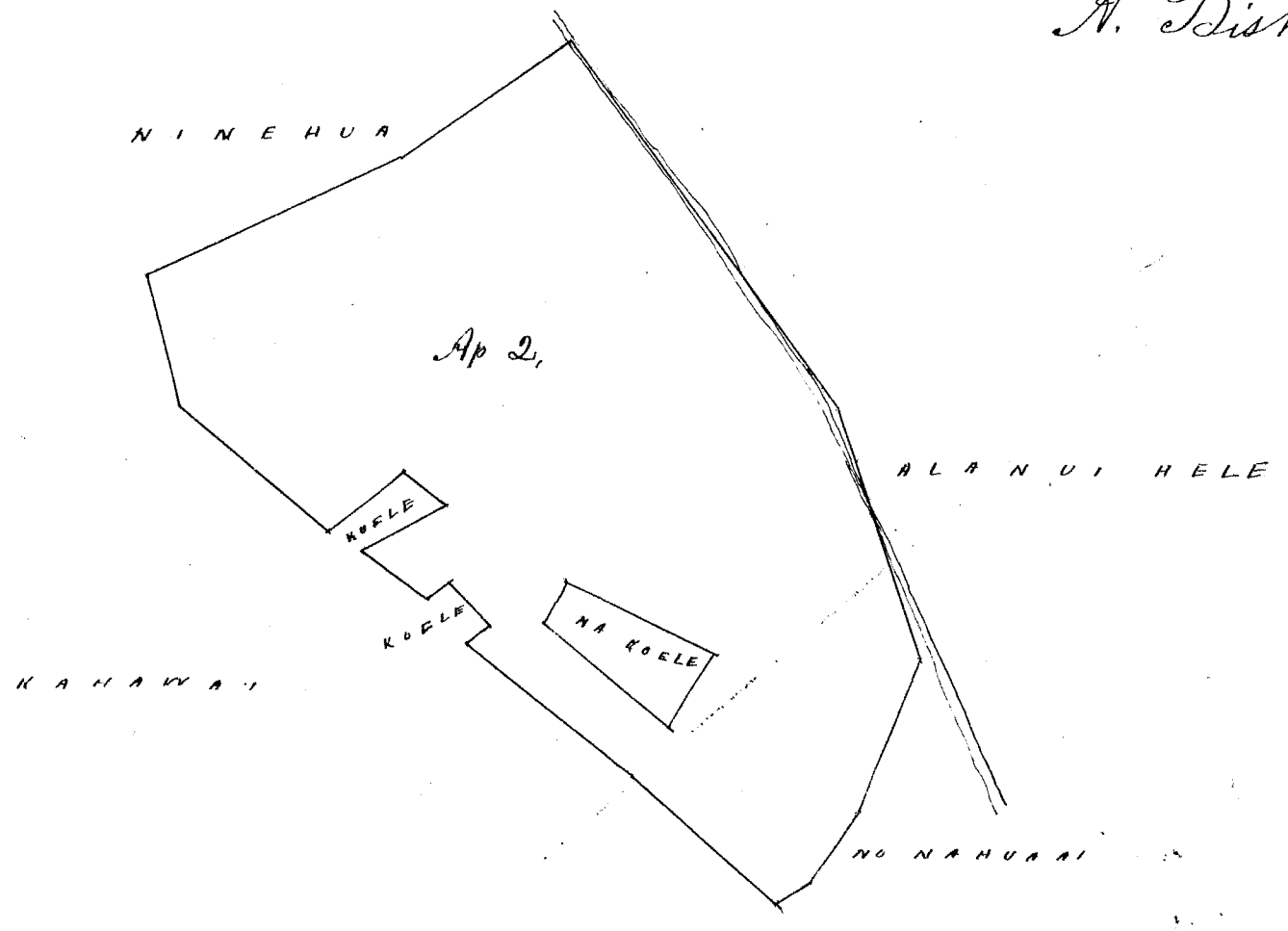

Wm Pau Lau #6
 W. L. Lee
 G. M. Robertson
 J. H. Smith
 J. Kikaulahao

Honolulu, 15. Sep. 1852.

Heleu 6630 NAKALINA ✓

Kalawa Molokai

Ke Moa'aina i Kamoku, Kalawa Molokai,
 E hoomaka ana ma ke Pihī Akau, e hulu ana, Nem. 36°, Nihē, i 1.46 Kh, ma ke pāpāna
 no Mahi, Malaila aku, Nem. 29 1/2°, Nihē, i 3.45 Kh, ma ke Mahi, Malaila aku, Nem.
 30°, Nihē, i 15.3 Kh, ma ke Konoehiki, Malaila aku, Ak. 74°, Nihē, i 0.34 Kh, ma ke Ka-
 hule, Malaila aku, Ak. 31 1/2°, Kom. i 1.37 Kh, ma ke Kahule, Malaila aku, Ak. 29° Kom.
 i 2.95 Kh, Malaila aku, Nem. 62°, Kom. i 0.14 Kh, Malaila aku, Ak. 35°, Kom. i 1.64 Kh,
 ma ke Kahule, Malaila aku, Ak. 57°, Kom. i 0.45 Kh, a ke hoomaka ana, he 0.60 Kh
 huinaha

Apāna 2, mau Ii & Kula i Kamoku,
 E hoomaka ma ke Pihī Kīkīna e hulu ana, Nem. 65°, Kom. i 0.47 Kh ma ke Kōle Malaila aku
 Ak. 36° Kom. i 0.92 Kh, ma ke Kahule, Malaila aku, Ak. 53 1/2° Nihē, i 0.61 Kh, ma ke
 auwai, Malaila aku, Nem. 26°, Nihē, i 10.2 Kh, ma ke NAKALINA, Ak. 0°, 5 1/10 Kh,
 Pau loa, 1.60 Kh, huinaha,

A. Bishop.
Mea ana.

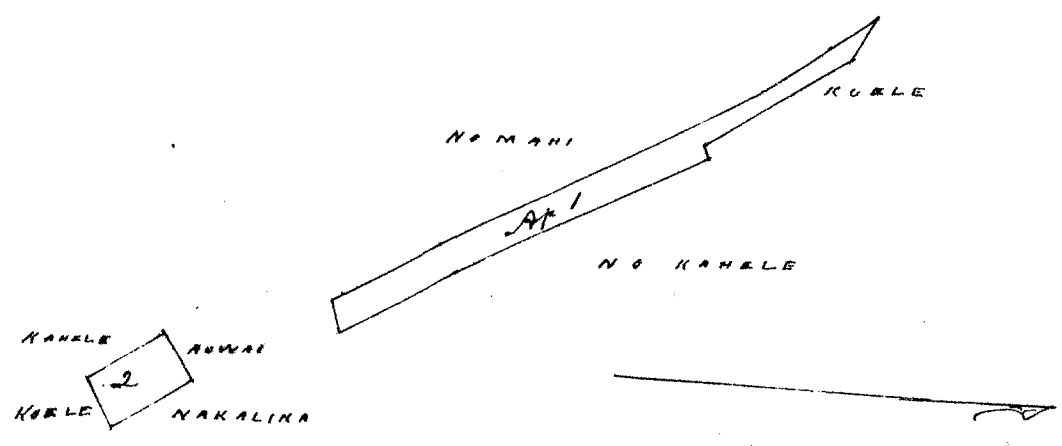

Uku Pau Loa #4.

H. L. Lee
G. M. Robertson
J. H. Smith
J. Kekaulahao

Honolulu, 15. Sep. 1852.

Heleu 5010 Koaahu i 15217 Kalawa Molokai

Apana 1. He moa aina i loko o Kaopa, Kalawa, Molokai,
E hoomaka ma ke Pihikoma, e hulu ana, Ak. 29 1/2 Kom i 0.56 Kh, ma ka palena mo
Moaa, Malaila aku, Kom. 59 Kom i 0.94 Kh, ma ke Moaa, Malaila aku, Ak. 27 Kom i
1.23 Kh, ma ke Moaa, Malaila aku, Ak. 67 1/2, Nite i 0.95 Kh, ma ke Koele, Malaila aku,
Ak. 4, Nite i 0.40 Kh, Malaila aku, Ak. 61, Nite i 0.90 Kh, ma ke Koele, Malaila
aku, Kom. 27 1/2, Nite i 1.70 Kh, ma na palena loi i aumeumua me Konoehiki, Mal
aila aku, Kom. 60 Kom i 0.95 Kh, ma ke Poalima, a ka hoomaka ana
he 7.40/100 Kh huinaha

Apana 2. E hua loi i paa i ke Konoehiki, ma Kaahu e ovaki ana
E hoomaka ma ke Pihikoma, e hulu ana, Kom. 27 1/2 Nite i 1.70 Kh, ma ke Kaahu
Kulu ana, Malaila aku, Ak. 60 Nite i 0.83 Kh, ma ke Konoehiki, Malaila aku, Ak. 30,
Kom i 1.74 Kh, ma ke Konoehiki, Malaila aku, Kom. 60, Kom i 0.83 Kh, a ka hoomaka
ana, he 136/100 Kh huinaha

Apana 3. He Kula maluku, Kaopa,
E hoomaka ana ma ke Pihikoma, e hulu ana, Kom. 39, Nite i 0.40 Kh, ma ke Kula
Konoehiki, Malaila aku, Kom. 67, Kom i 1.85 Kh, ma ke Koele, Malaila aku,
Ak. 39, Kom i 0.40 Kh, Malaila aku, Ak. 67, Nite i 1.85 Kh, he 0.74/100 Kh huinaha

Apana 4. He Kula maluku i Kaopa,
E hoomaka ma ke Pihikoma, e hulu ana, Ak. 20, Kom i 9.66 Kh, ma ke Moaa,
Malaila aku, Ak. 73, Nite i 1.70 Kh, ma ka pa hale pule, Malaila aku,
Kom. 6 1/2, Nite i 9.47 Kh, ma ke Konoehiki, Malaila aku, Kom. 60, Kom
i 1.39 Kh, he 1.55/100 Eka, Pau loa, 2.05/100 ma Eka,

A. Bishop
ma ana

Emana avaa 568.47

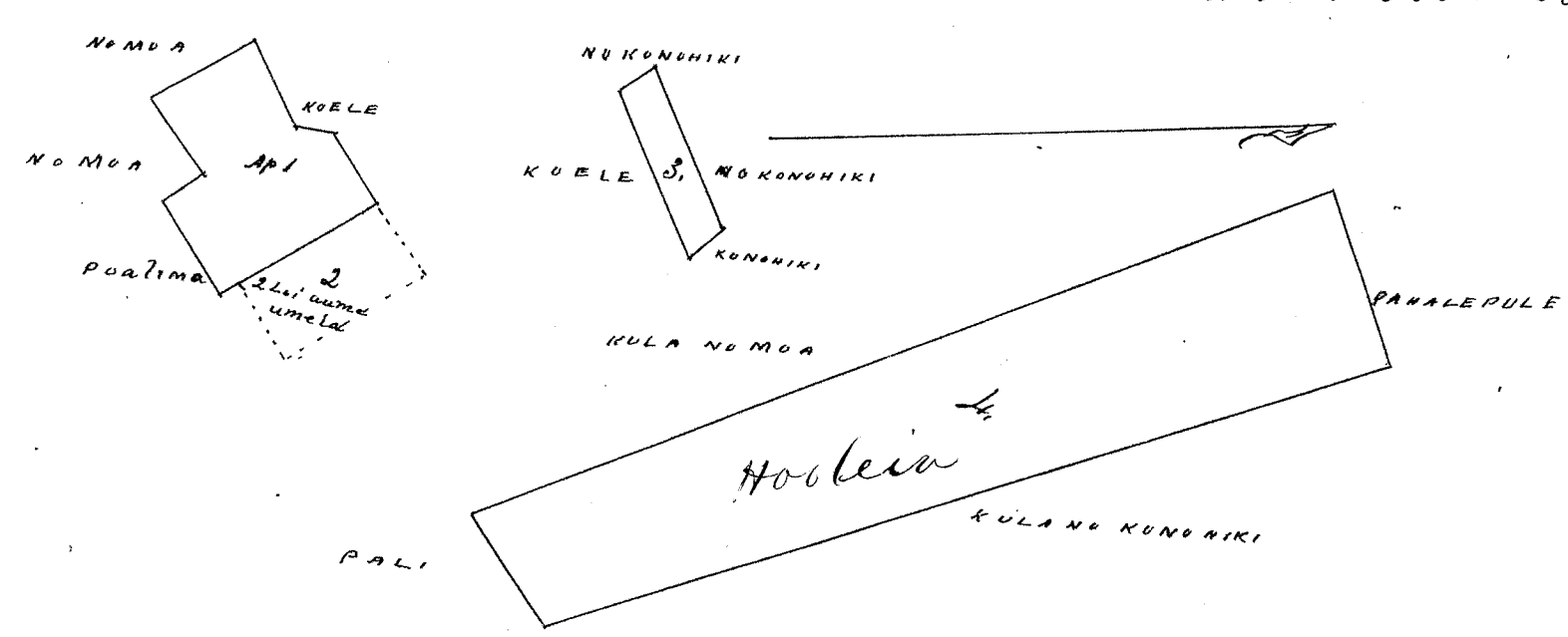

Uku Pau Loa #5

G. M. Robertson

Honolulu, 15. Sep. 1852.

Heleu 10622. Pa.

Palolo Oahu.

Apana 1. Pahale. Pambala, ili. Waiohau, Palolo, Oahu,
 E hoomaka ana ma ke kahi Komohana, e hulu ana, Ak. 59; Hiki: 260 Kh, ma
 ke Konoheki; Malaila aku, Ak. 52; Hiki: 200 Kh, ma Kahawai, Malaila
 aku, Ak. 59; Kom. i 260 Kh, ma Konoheki, Malaila aku, Ak. 42; Kom. i 200
 Kh, a hiki i ka hoomaka ana, ke 5, 20/100 Kh, huinaha,

Apana 2, Ke moana, Kahaliu, ili. Waiohau,
 E hoomaka ana ma ke kahi Kona, e hulu ana, Ak. 31 1/2; Hiki: 350 Kh, ma ka palena
 a no Konoheki; Malaila aku, Ak. 64 1/2; Hiki: 200 Kh, ma ka palena no
 Kahawai, Malaila aku, Ak. 19; Hiki: 100 Kh, Malaila aku, Ak. 85; Kom. i 190
 Kh, ma ka palena no Kahawai, Malaila aku, Ak. 25; Kom. i 050 Kh, Malaila
 aku, Ak. 75; Kom. i 174 Kh, ma ka palena no Konoheki, Malaila aku, Ak. 27 1/2
 Kom. i 056 Kh, Malaila aku, Ak. 80; Kom. i 170 Kh ma ka palena no Konoheki
 malaila aku, Ak. 31; Hiki: 030 Kh, Malaila aku, Ak. 37; Kom. i 196 Kh, ma
 ke Konoheki; Malaila aku, Ak. 46; Hiki: 380 Kh, ma ka palena no Kalamoa,
 a hiki aku i ka hoomaka ia ai, 1 Eka, 6 2/100 Kh huinaha,
 Hui pau loa, 2 Eka, 18 2/100 Kh, huinaha

A. Bishop
mea ana,

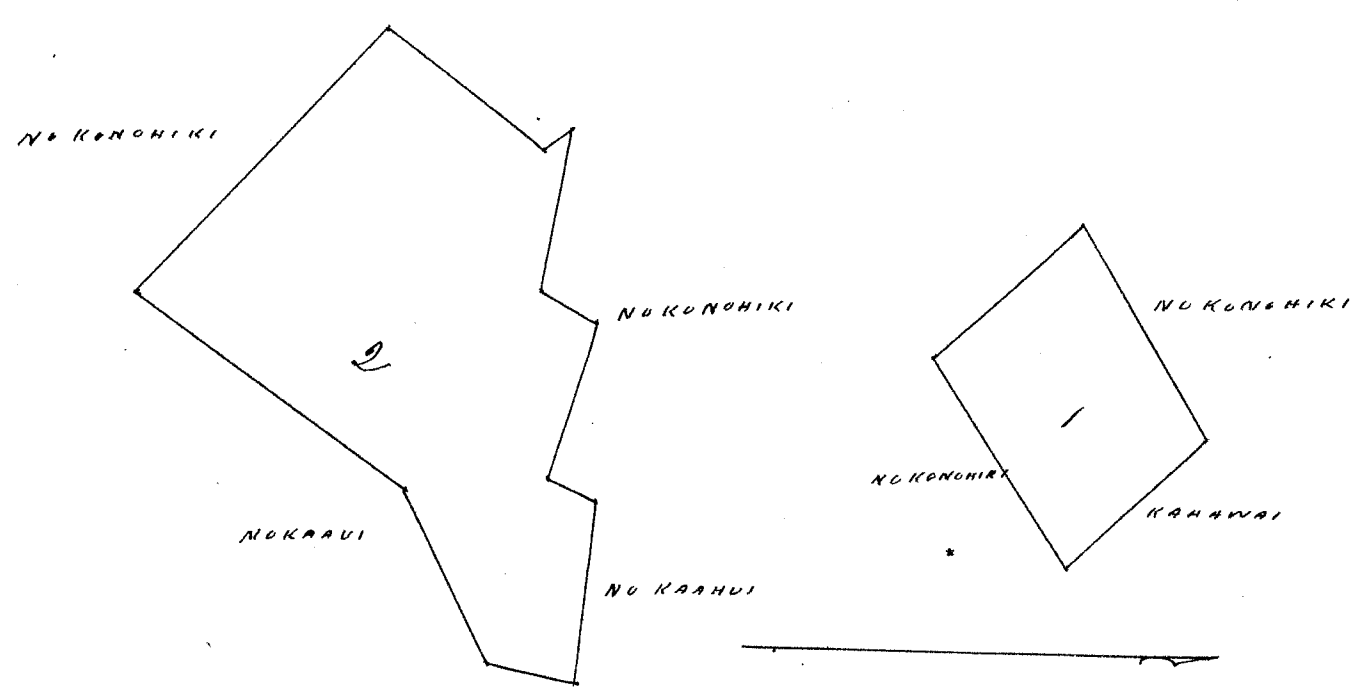

Uku Pau Loa # 6.
 W. L. H. H.
 G. M. Robertson
 J. H. Kaulahao
 J. H. Smith

Honolulu, Oahu, 21. Sep. 1852

Heleu 6517 Waipio

Kalawa Molokai.

Ke moana; loko. Kamoku, Kalawa, Molokai;
 Apana 1. E hoomaka ma ke kahi Akau, e hulu ana, Ak. 29 1/2; Hiki: 246 Kh ma
 ka palena no Wahineaea, Malaila aku, Ak. 67; Kom. i 13. Kh, Malaila aku,
 Ak. 30; Hiki: 122 Kh, ma ke Wahineaea, Malaila aku, Ak. 26; Hiki: 146 Kh,
 ma Kahawai, Malaila aku, Ak. 73; Kom. i 43 Kh, Malaila aku, Ak. 27
 Kom. i 322 Kh, ma ka palena no Mahi, Malaila aku, Ak. 75; Kom. i 017 Kh,
 Malaila aku, Ak. 30; Kom. i 181 Kh, ma ke Mahi, Malaila aku, Ak. 58;
 Hiki: 082 Kh, a hiki i ka hoomaka ana, ke 2 43/100 Kh, huinaha,

Apana 2, Ke Kula ma Kamoku.
 E hoomaka ma ke kahi Akau, e hulu ana, Ak. 54 1/2; Hiki: 484 Kh, ma ka palena
 no Wahineaea, Malaila aku, Ak. 46; Kom. i 060 Kh, ma ke Kula, Malaila
 aku, Ak. 47 1/2; Kom. i 320 Kh, ma ke Mahi, Malaila aku, Ak. 30; Kom. i
 200 Kh, ma Kula, a ka hoomaka ana, ke 3 23/100 Kh, huinaha,
 Pau loa, 6, 15/100 Kh, huinaha,

A. Bishop,
mea ana,

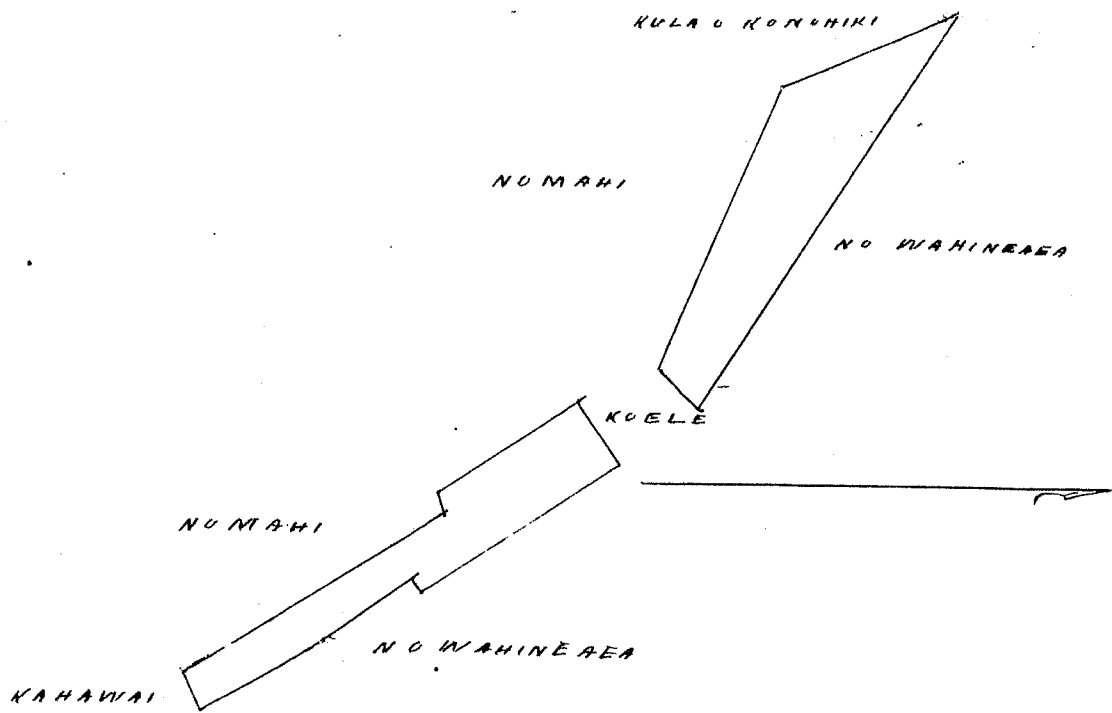

Wku - Pau loa p 4.

W. L. Lee
 G. M. Robertson
 J. H. Smith
 J. Kekaulaheo

Honolulu 15 Sep 1852.

Koelu 6670 Moaki

Kalawa Mookai.

Apana 1. Ite Moaaina i loko o Keauhou, Kalawa, Mookai.
 E hoomaka ana ma ke Pihikiki a e huli ana, Hem. 60° Kom i 1.09 Ah. ma Kahawai
 Malaila aku, Ak. 38° Kom. i 1.18 Ah. ma Ke Kalanahua, Malaila aku Ak. 48°
 Hiki i 0.88 Ah. ma Ke Koele, Malaila aku, Ak. 40 1/2° Kom. i 0.50 Ah. Malaila
 aku, Hem. 58 1/2° Kom. i 0.83 Ah. ma Ke Koele, Malaila aku, Ak. 38° Kom i 1.00
 Ah. ma Ke Kalanahua, Malaila aku, Ak. 44 1/2° Hiki i 1.46 Ah. ma Ke Koele
 Malaila aku, Hem. 32° Hiki i 3.20 Ah. ma Ke Kewalo, a ka hoomaka ana,
 Ak. 33 1/2° Ah. huihana Eili ma 1 Ruda. 13 Perka.

W. H. Pease.

Apana 2, Ite Puka o maluna o ke Koele.
 E hoomaka ana ma ke Pihikiki a e huli ana, Hem. 52° Kom i 1.70 Ah. ma ka
 paluna Koele, Malaila aku, Ak. 34° Kom. i 2.80 Ah. ma Ke Kalanahua, Mal
 ailu aku, Ak. 32° Hiki i 0.90 Ah. Malaila aku, Hem. 38° Hiki i 3.00 Ah.
 ma Ke Kewalo, a ka hoomaka ana, Ak. 2. 6 3/100 Ah. huihana,

Apana 3, Ite Moaaina i loko o Kamuku.
 E hoomaka ana ma ke Pihikiki a e huli ana, Ak. 30 1/2° Hiki i 1.90 Ah. ma ka paluna
 ma Waipio, Malaila aku, Hem. 53° Kom. i 0.50 Ah. ma Ke Auwai, Malaila aku,
 Hem. 23 1/2° Hiki i 1.00 Ah. ma Ke Takalina, Malaila aku, Hem. 36° Hiki i
 2.45 Ah. ma Ke Takalina, Malaila aku, Hem. 29 1/2° Hiki i 1.45 Ah. Malaila
 aku, Ak. 58 1/2° Hiki i 0.42 Ah. ma Ke Koele, a ka hoomaka ana, Ak.
 2. 39 1/100 Ah. huihana, Pau loa, 8 33 1/100 Ah. huihana -

A. Bishop
mea ana,

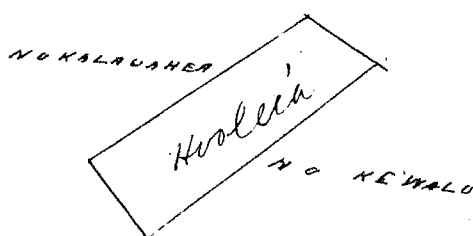
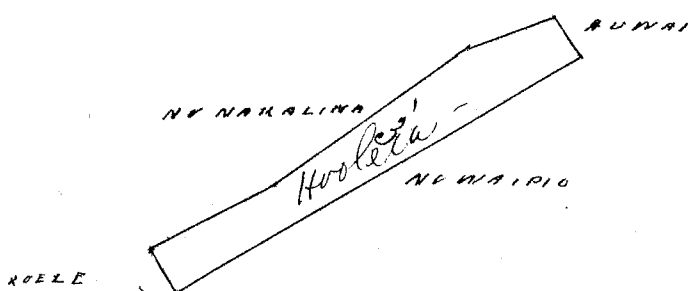
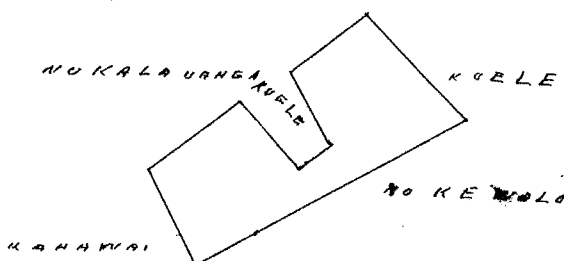

Wm Pau Loa Jr.

W. L. Lee

G. M. Robertson

J. H. Smith

J. Kekaulahas

Honolulu 15 Sep 1852

Keolu 5197 Kane & Hau. Hoilina

Kalawa Molokai

Apawa 1. Iki aina o Kakaiaha, Kalawa, Molokai; E hoomaka ma ke Pihikiki, Hima, e huli ana, Komohana, i 219 Kh. ma Kula no Konohiki, Mataila aku, Ak. 18, Hiki: 626 Kh. Mataila aku, Ak. 4, Hiki: 670 Kh. ma ka Poalua, Mataila aku, Hem. 14, Hiki: 490 Kh. ma Kula no Konohiki, Mataila aku, Hem. 1, Hiki: 640 Kh. ma ke Kuanua, a ka hoomaka ana, He 1 1/2/100 Eka,

Apawa 2, ke Loi me ke Kula: Kakaiaha, E hoomaka ma ke Pihikiki, Hem. Akau, e huli ana, Hiki: 200 Kh. ma ke Konohiki; Mataila aku, Hem. 2, Kom i 0.64 Kh. ma ke Konohiki; Mataila aku, Hem. 61, Hiki: 0.26 Kh. Mataila aku, Hem. 9 1/2, Kom i 0.39 Kh. Mataila aku, Hem. 19, Hiki: 0.59 Kh. Mataila aku, Hem. 1, 24 Kh. ma ke Konohiki; Mataila aku, Ak. 7 1/2, Kom i 226 Kh. ma ka Kahawai; Mataila aku, Ak. 15, Kom i 231 Kh. ma ke Konohiki, a hiki: ka hoomaka ana, He 5.70/100 Kh. huinaha, Pau loa, 1. 83/100 Eka,

A. Bishop
Mea ana,

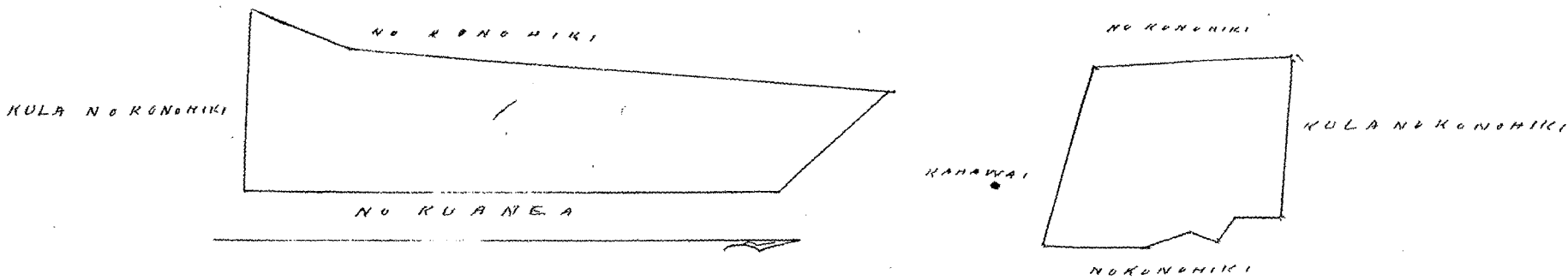

Wm Pau Loa Jr.

W. L. Lee

G. M. Robertson

J. H. Smith

J. Kekaulahas

Honolulu 15 Sep 1852

Keolu 8934 Kaianui

Kalawa Molokai

Moo aina i loko o Kamohu, Kalawa, Molokai; E hoomaka ma ke Pihikiki, Hima, e huli ana, Ak. 45, Kom i 267 Kh. ma ka pualua no Kamehameha, Mataila aku, Ak. 12, Kom i 5.60 Kh. Mataila aku, Hem. 25, Hiki: 130 Kh. ma Kula o Konohiki; Mataila aku, Hem. 3 1/2, Hiki: 1.20 Kh. ma ka pualua no Paahaa, Mataila aku, Hem. 38 1/2, Hiki: 2.64 Kh. Mataila aku, Ak. 16, Hiki: 1.05 Kh. ma ke Kolu, a ka hoomaka ana, He 1.24/100 Kh. huinaha,

Apawa 2, ka Loi i loko o Moo i Kamohu; E hoomaka ma ke Pihikiki, Akau, e huli ana, Hem. 60, Kom i 0.76 Kh. ma ke Kolu; Mataila aku, Hem. 3 1/2, Hiki: 1.78 Kh. ma ke Paahaa; Mataila aku, Hem. 29, Hiki: 3.00 Kh. Mataila aku, Ak. 15, Hiki: 0.85 Kh. ma ka Kahawai; Mataila aku, Ak. 30, Kom i 1.60 Kh. ma ke Kamehameha, a ka hoomaka ana, He 3.70 Kh. Pau loa, 8.64/100 Kh. huinaha,

A. Bishop
Mea ana,

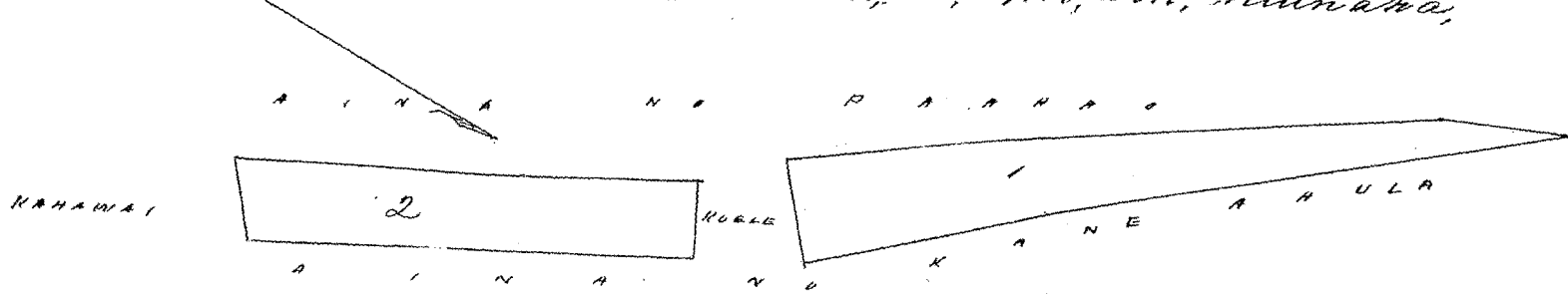

Wku Pau Loa # 4
W. L. Lee
G. M. Robertson
J. M. Smith
J. Kekaulahao

Honolulu 15 Sep. 1852
No. 8910 Kawaiinui Halawa, Molokai

Iki aina Lalohana, Halawa, Molokai,
E hoomaka ma ke Pihikomoehana, e hulu ana, hem. 10° Nite i 4,79 Kk. ma ka palane
na Kaaa, Malaila aku, hem. 24 1/2° Nite i 1,88 Kk. ma ke Konoheki, Malaila aku,
AK, 40; Nite i, 5,60 Kk. ma ka palane, Malaila aku, AK, 47 1/2° Nite i 4,59 Kk.
ma ke Popoki, Malaila aku, hem. 64° Nite i, 1,17 Kk. ma ke Koele, Malaila aku,
hem. 11° Nite i, 0,40 Kk. ma ke Koele, Malaila aku, hem. 78 Nite i, 1,00 Kk. a
hite i ka hoomaka ana, AK, 2, 1/6 ma Eka,

Apuna D. Iki mo i hoko Lalohana,
E hoomaka ma ke Pihikomoehana, e hulu ana, hem. 73° Nite i 1,04 Kk. ma ka palane
Koele, Malaila aku, AK, 36° Nite i, 1,87 Kk. ma ke Kaaa, Malaila aku, AK, 41°
Nite i, 0,46 Kk. ma ke Koele, Malaila aku, AK, 29° Nite i, 4,15 Kk. ma ke Koele
Malaila aku, AK, 63 1/2° Nite i, 1,18 Kk. Malaila aku, hem. 28° Nite i 4,43 Kk.
ma ke Popoki, Malaila aku, hem. 22 1/2° Nite i, 2,00 Kk. ma ke Popoki, a
ka hoomaka ana, AK, 8 Kk. huihana, Pau loa, 2, 9/16 ma Eka,

A. Bishop,
Mea ana,

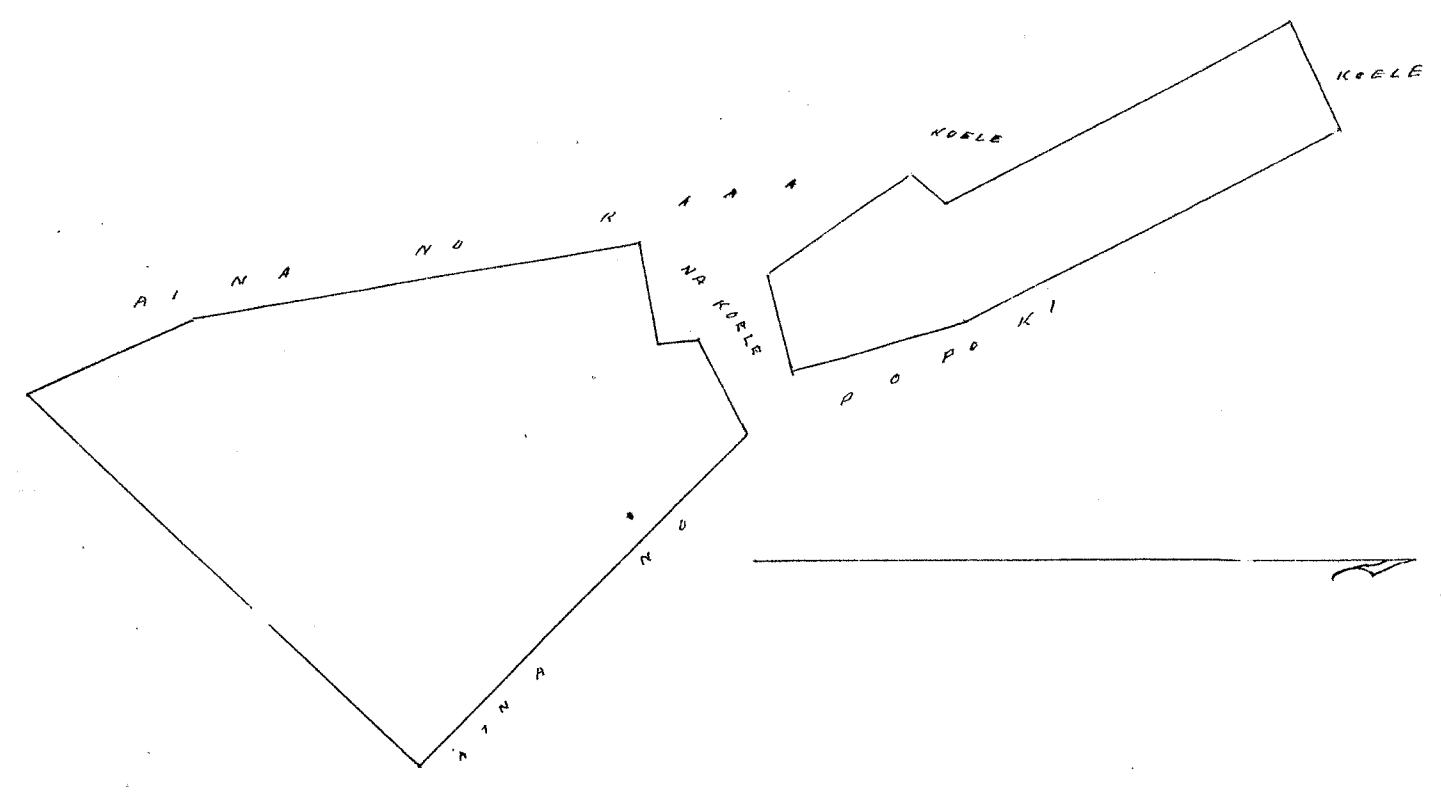

Wku Pau Loa # 5
W. L. Lee
G. M. Robertson
J. M. Smith
J. Kekaulahao

Honolulu 15 Sep. 1852,

Helu 8955 Kaloa.

Kalawa, Molokai.

Apana 1, He mau Ioi loko. Kaili; Kalawa, Molokai;
E hoomaka ma ke kahi Nema, e hiki ana, Ak. 61, Niki, 0,70 Kh. ma ka palena
Kole, Malaila aku, Ak. 26; Kom, 1,75 Kh. ma ka palena no Iona, Malaila aku,
Ak. 65, Kom, 0,96 Kh. ma ke Kole, Malaila aku, Ak. 33, Niki, 1,80 Kh. ma ke
Amala, He, 1,60/100 Kh. huinaha,

Apana 2, He mau aina i loko. Kaili;
E hoomaka ma ke kahi Kikina, e hiki ana, Ak. 63, Kom, 0,96 Kh. ma ka palena
Kole, Malaila aku, Ak. 31, Kom, 3,71 Kh. ma ke Kikina, Malaila aku, Ak.
82 1/2, Kom, 1,75 Kh. Malaila aku, Ak. 3 1/2, Kom, 1,00 Kh. Malaila aku, Ak.
53, Niki, 2,62 Kh. ma ka palena, Malaila aku, Ak. 31, Niki, 5,55 Kh.
ma ke Iona, a ka hoomaka ana, He 7 2/3 Kh. huinaha,
Pau loa, 8, 83/100 Kh. huinaha,

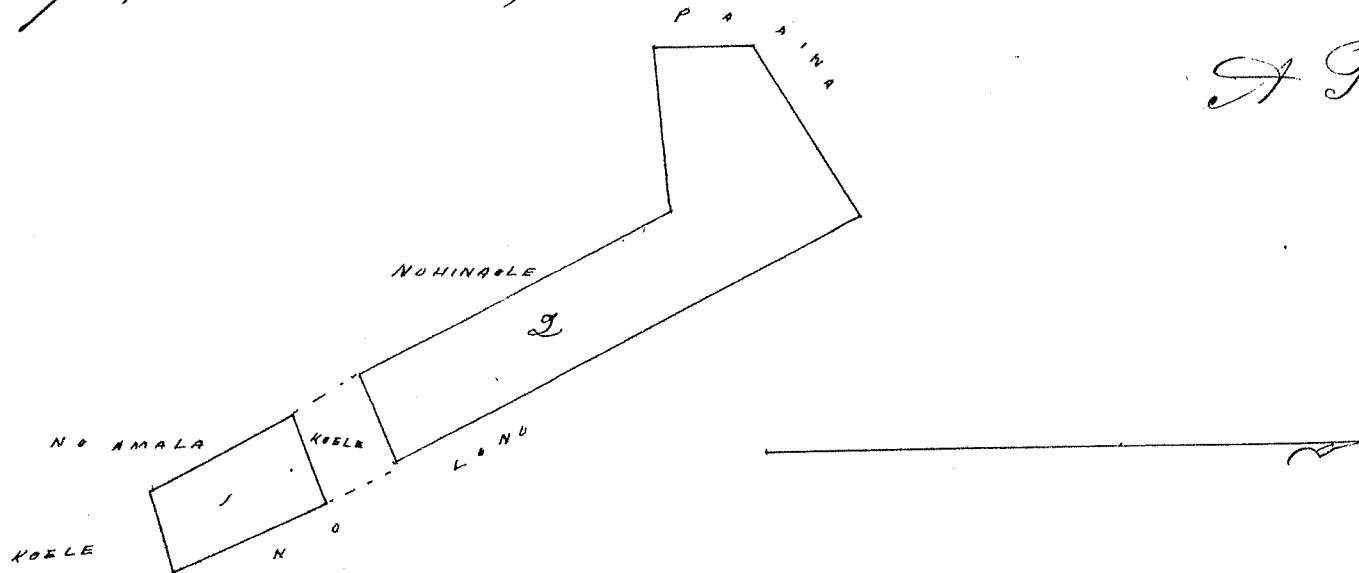

A Bishop
Mea ana,

Wai Pau Iona
W. L. Lee
G. M. Robertson
J. H. Smith
J. H. Kaulahau

Honolulu Oahu 15 Sep 1852,

Helu 6300 Kairiwinui

Kalawa Molokai

Iki aina o Kairiwinui, Kalawa, Molokai;
E hoomaka ma ke kahi Akau, e hiki ana, Ak. 26, Niki, 1,81 Kh. Malaila aku, Ak.
46, Kom, 0,40 Kh. Malaila aku, Ak. 53 1/2, Niki, 5,50 Kh. ma ka palena no
Kakii, Malaila aku, Ak. 50, Kom, 1,77 Kh. ma ke Kairiwinui, Malaila aku,
Ak. 36, Kom, 2,32 Kh. ma ke Kawahae, Malaila aku, Ak. 50 1/2, Niki, 0,
16, Kh. Malaila aku, Ak. 1 1/2, Kom, 3,08, Kh. ma ke Kawahae, Malaila
aku, Ak. 46, Kom, 2,00 Kh. Malaila aku, Ak. 56, Niki, 1,70 Kh. ma ke
alanui, a ka hoomaka ana,
He 8 1/2 Kh. huinaha,

A Bishop
Mea ana,

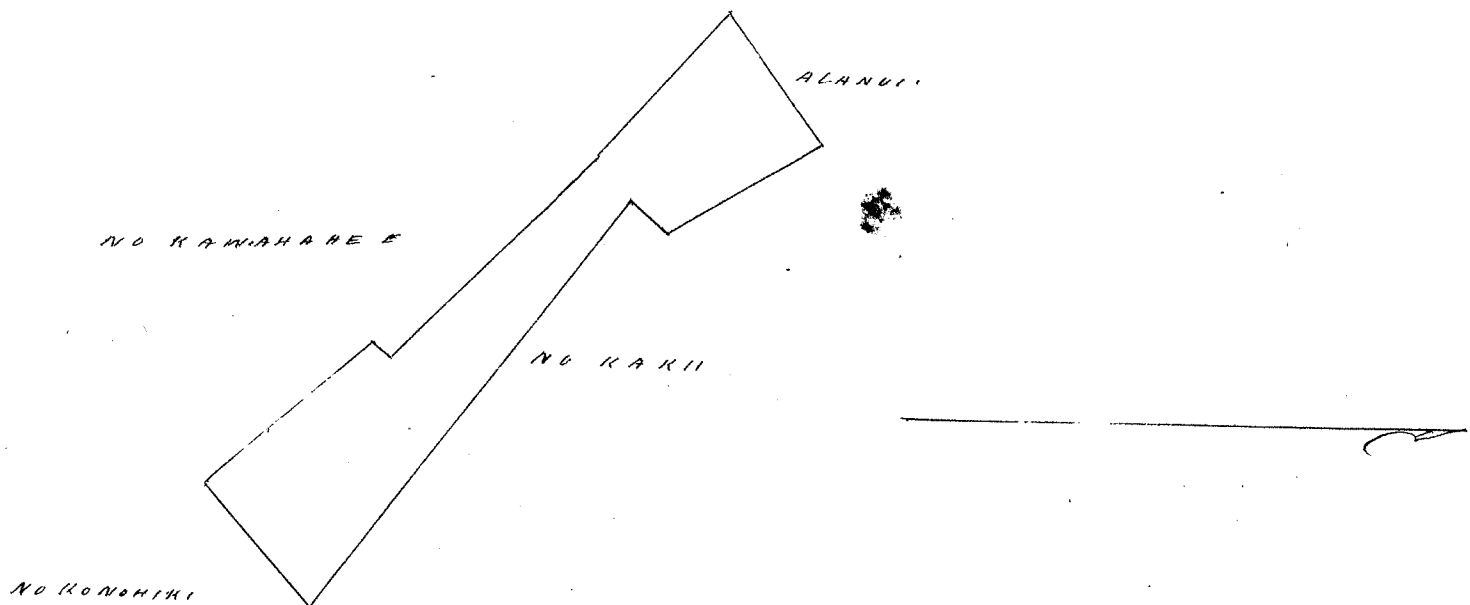

Wm Pau Lou & Co
W. L. Lee
G. M. Robertson
J. H. Smith
J. M. Kaulahao

Honolulu 15 Sep 1852

Keleu 5071 Kaili Kalahale Hoilina Kalawa Molokai

Ke moa aina i loko o Kaaaula, Kalawa, Molokai;
E hoomaka ma Ke Kahi Hikiina, e hiki ana, AK. 40° Kom i 5.50 Kh. ma ka palena
no Peleleu, Malaila aku, AK. 43° Kom i 3.57 Kh. no Peleleu, Malaila aku,
AK. 24 1/2° Kom. i 1.63 Kh. Malaila aku, Kom. 68° Kom. i 0.22 Kh. Malaila aku,
AK. 29° Kom. i 2.12 Kh. ma na Koele, Malaila aku, Kom. 65° Kom. i 0.75 Kh.
ma na Koele, Malaila aku, Kom. 28° Hiki i 1.30 Kh. ma ka palena no Popoki
Malaila aku, Kom 33° Kom. 0.30 Kh. Malaila aku, Kom. 27° Hiki i 1.64
Kh. ma Ke Popoki, Malaila aku, Kom. 41° Hiki i 1.70 Kh. Malaila aku,
Kom. 44 1/2° Hiki i 3.00 Kh. Malaila aku, AK. 67° Hiki i 0.70 Kh. ma ka
pali; a hiki i ka hoomaka ana, He 1 1/2/100 Eka,

A. Bishop
mea ana,

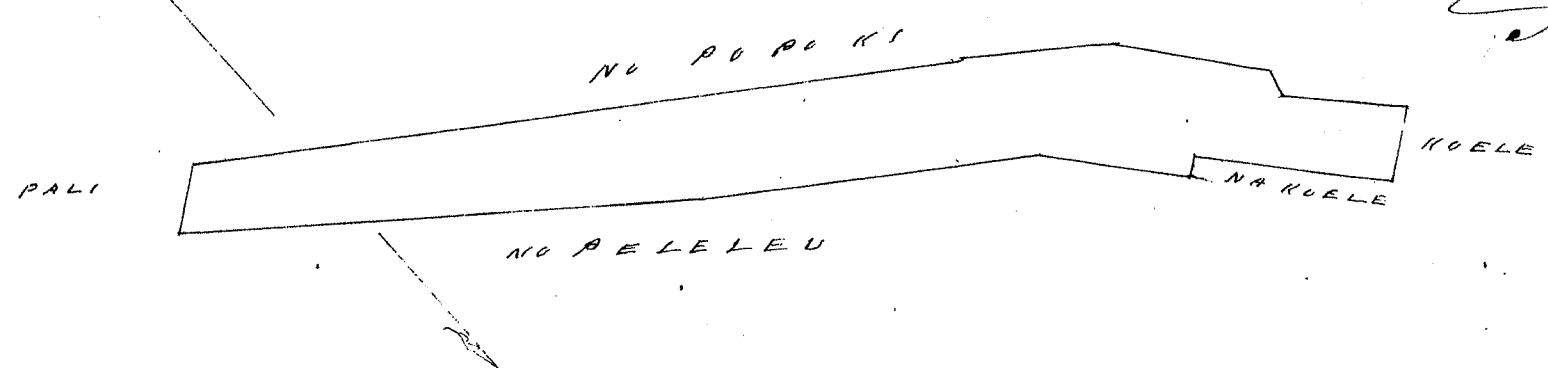

Wm Pau Lou & Co
W. L. Lee
G. M. Robertson
J. H. Smith
J. M. Kaulahao

Honolulu 15 Sep 1852

Keleu 5203 Kauhale Kalawa Molokai

Ke aina o Kauhale 2. Kalawa, Molokai;
E hoomaka ma Ke Kahi Akau, e hiki ana, Kom. 6 1/2° Hiki i 4.42 Kh. ma ka palena
no Kuuwa, Malaila aku, AK. 73° Hiki i 0.70 Kh. Malaila aku, Kom 13° Hiki i
0.67 Kh. ma ka palena Koele, Malaila aku, Kom. 75° Kom. i 0.69 Kh. ma Ke
Kuuwa, Malaila aku, Kom. 9 1/2° Hiki i 1.18 Kh. ma Ke Kuuwa, Malaila aku,
Kom. 80 1/2° Kom. i 3.00 Kh. Malahawai, Malaila aku, AK. 6 1/2° Kom. i 0.54 Kh.
ma Ke Konoehiki, Malaila aku, AK. 46° Hiki i 0.48 Kh. Malaila aku, AK.
8° Kom. i 0.57 Kh. Malaila aku, Kom. 75° Kom. i 0.95 Kh. ma Ke Konoehiki,
Malaila aku, AK. 3 1/2° Kom. i 3.00 Kh. ma Ke Kahuu palena, Malaila aku,
AK. 5 1/2° Hiki i 3.80 Kh. ma Kumu pali; a hiki i ka hoomaka ana,
He 1 7/2/100 Eka,

A Bishop
mea ana,

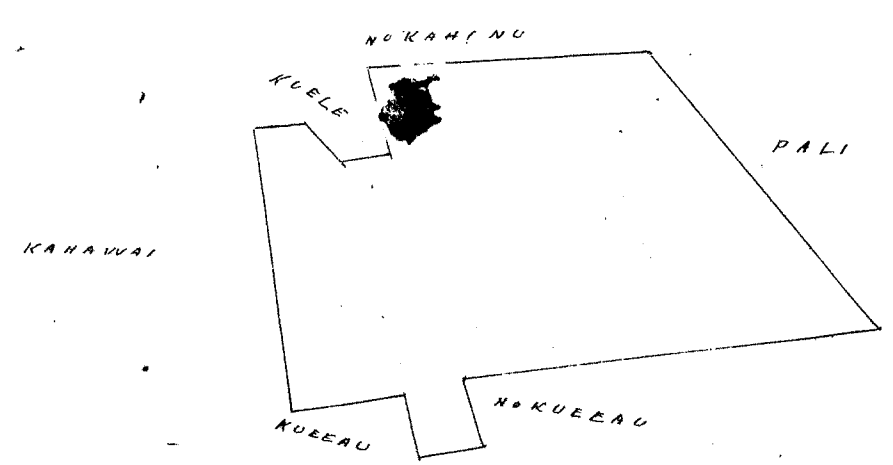

Uku Pau Loa # 4.

N. L. Lee
G. M. Robertson
C. H. Smith
J. Kekaulaheo

Honolulu 15 Sep 1852

Uku 6757 Opulua

Kalawa Mookai

Moo aima i loku o Keauhou, Kalawa Mookai.
E hoomaka ma ke Pihia Akau, e hulu ana, Hem. 39° Nite; 200 Kh. ma ka palena o Puana
Mabaita aku, Hem. 35° Nite; 150 Kh. ma ke Puana, Mabaita aku, Hem. 7 1/2° Nite; 95
Kh. Mabaita aku, Hem 16° Nite; 294 Kh. ma ke Puana, Mabaita aku, Hem. 26° Nite;
215 Kh. Mabaita aku, Hem. 67° Kom; 0.55 Kh. ma ke Koele, Mabaita aku, Hem. 37°
Nite; 0.47 Kh. Mabaita aku, Hem. 32° Kom; 0.33 Kh. Mabaita aku, Hem. 81° Kom;
0.40 Kh. ma ke Koele, Mabaita aku, Ak. 13° Kom; 180 Kh. Ma ka palena o
Kama, Mabaita aku, Ak. 30° Kom; 4.82 Kh. ma ke Kama, Mabaita aku,
Ak. 45° Kom; 3.10 Kh. Mabaita aku, Ak. 68° Nite; 150 Kh. ma ke Konoiki a ka
hoomaka ana, Ak. 1 1/3 Eka,

A. Bishop,
Ina ana

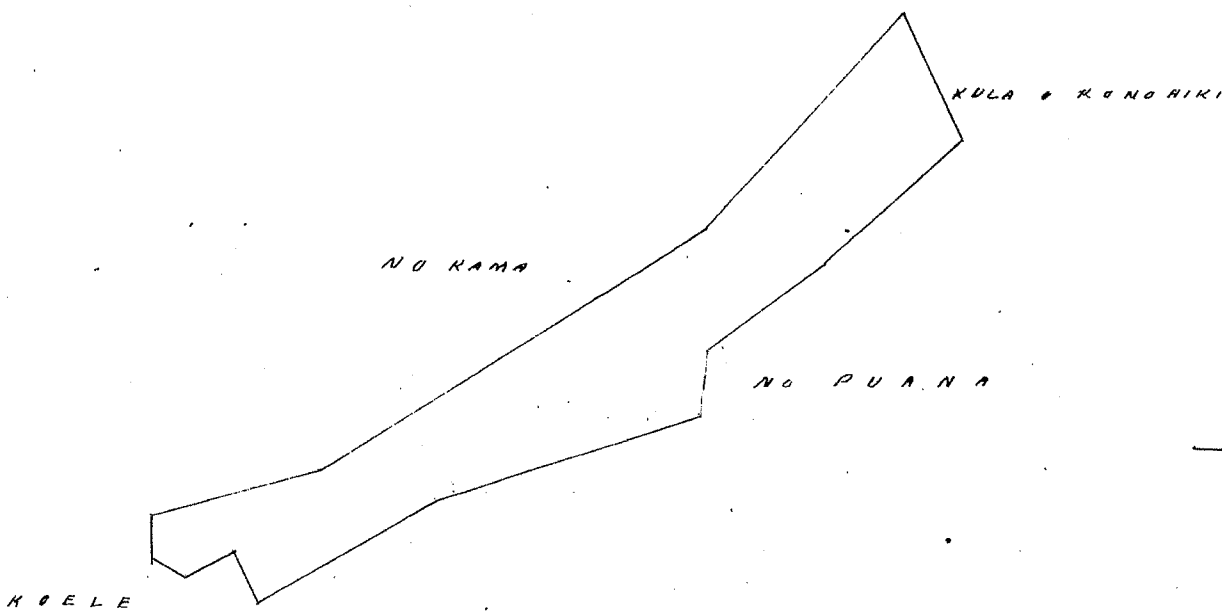

Uku Pau Loa # 4.

N. L. Lee
G. M. Robertson
C. H. Smith
J. Kekaulaheo

Honolulu 15 Sep 1852

Uku 6523 Kaole Kama Kooilina

Kalawa Mookai

Moo aima i loku o Keauhou, Kalawa Mookai.
E hoomaka ma ke Pihia Kooilina, e hulu ana, Ak. 13° Kom; 0.80 Kh. Mabaita aku, Ak. 30° Kom;
4.30 Kh. ma ke Opulua, Mabaita aku, Ak. 46° Kom; 4.80 Kh. ma ke Opulua, Mabaita
aku, Ak. 60° Kom; 1.10 Kh. Mabaita aku, Hem. 37° Nite; 5.80 Kh. ma ka palena o
Kaholowaa, Mabaita aku, Hem. 28° Nite; 4.92 Kh. Mabaita aku, Ak. 85° Nite;
90 Kh. Ak. 8 1/3 Eka, huihana

A. Bishop,
Ina ana aima

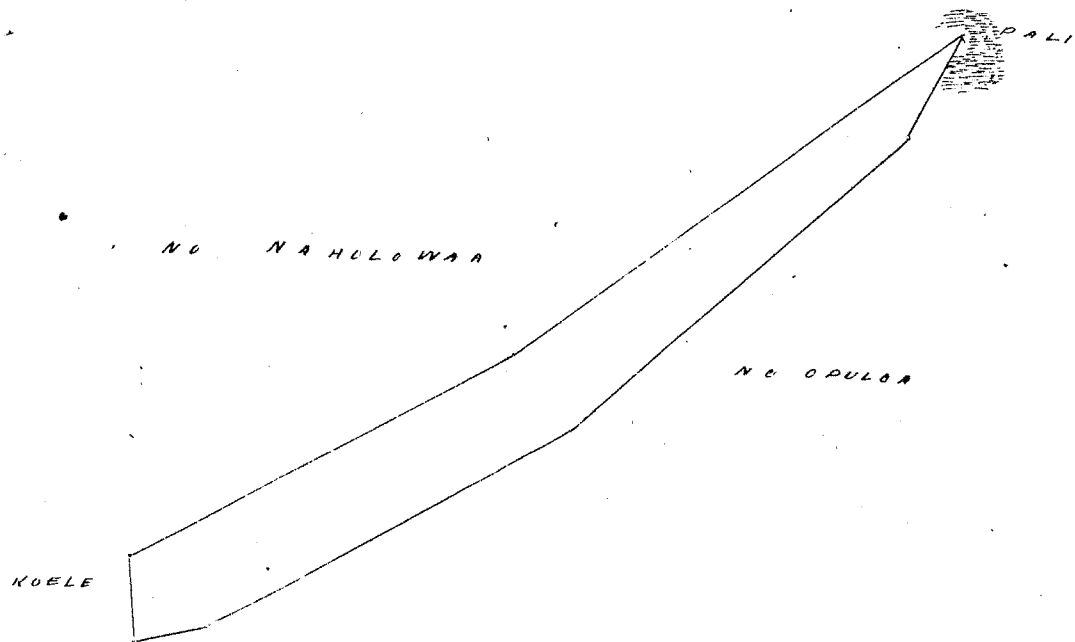

Uku Pau Loa / 4
W. L. Lee
G. M. Robertson
J. H. Smith
J. Kekaulaha

Honolulu 15 Sep 1852

Hoelu 168 B. Kowilikopaa

Honoulimalo Molokai

Mo'oina o Kumuohia, Honoulimalo, Molokai.
E hoomaka ana ke Piki Komohana, e hele ana, Ak. 44 Nite, i 175 Kh. ma ka palena
no Koa'ouka, e Matala'ia aku, Ak. 35, Kom i 150 Kh. e Matala'ia aku, Kom, 50 Nite i
370 Kh. ma Kahawai; Matala'ia aku, Kom, 48, Kom i 130 Kh. ma ke Kolu, ma-
laila, aku, Kom, 51 1/2 Nite, i 0, 40 Kh. Matala'ia aku, Kom, 74, Kom i 0, 67 Kh.
ma ke Kahopukahi, e Matala'ia aku, Ak. 49, Kom i 2, 10 Kh. ma ka pahi, a
hiki i ka hoomaka ana, He 5.81/100 Kh. huinaha

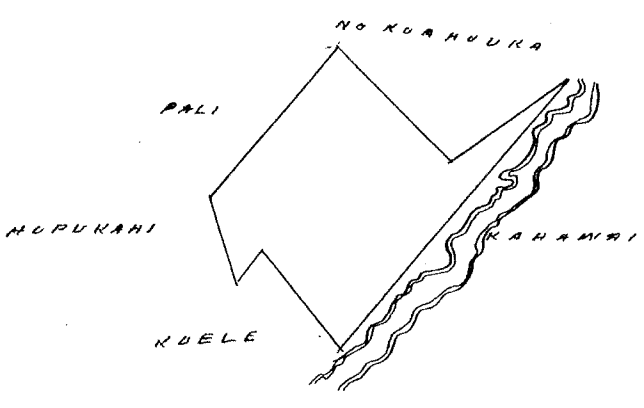

A. Bishop,
Mea ana,

Uku Pau Loa / 4
W. L. Lee
G. M. Robertson
J. H. Smith
J. Kekaulaha

Honolulu 15 Sep 1852

Hoelu 169 B. Koa'ouka

Honoulimalo Molokai

Apana 1. Aikula ma Kapuku, Honoulimalo, Molokai.
E hoomaka ana ke Piki Komohana, e hele ana, Ak. 30, Nite i 166 Kh. ma ka palena no Konoiki;
Matala'ia aku, Kom, 50, Nite i 652 Kh. ma Kala'awa. Matala'ia aku, Ak. 19, Kom i 860 Kh.
ma ke Kahopukahi; a hiki i ka hoomaka ana, He 1 1/2 Eka.

Apana 2. He Mo'oina ma Maka'opala'opala.
E hoomaka ana ke Piki Komohana, e hele ana, Kom, 88, Nite i 170 Kh. ma ka palena no Ka-
aite'aula, Matala'ia aku, Kom, 45, Nite i 0, 44 Kh. Matala'ia aku, Kom, 28, Nite i 163
Kh. ma ke Ka'aita'aula, Matala'ia aku, Ak. 44, Nite i 175 Kh. ma ke Ka'owili-
kopaa, Matala'ia aku, Ak. 35 Kom i 150 Kh. e Matala'ia aku, Ak. 6 1/2, Kom i
128 Kh. ma Kahawai; Matala'ia aku, Kom, 78, Kom i 0, 65 Kh. Matala'ia aku, Kom
63, Nite i 1, 65 Kh. ma ke Kolu, Matala'ia aku, Kom 14, Kom i 0, 66, Kh. Matala'ia aku,
Ak. 64, Kom i 1, 70 Kh. ma ke Kolu, Matala'ia aku, Ak. 4, Nite i 0, 50 Kh. Matala'ia
aku, Kom, 38, Kom i 1, 30 Kh. ma Kahawai, a hiki i ka hoomaka ana, He 4 03/100
Kh huinaha, Pau Loa, 1 90/100 Eka,

1.50 E
4.03 K
1E 5K
9.03K

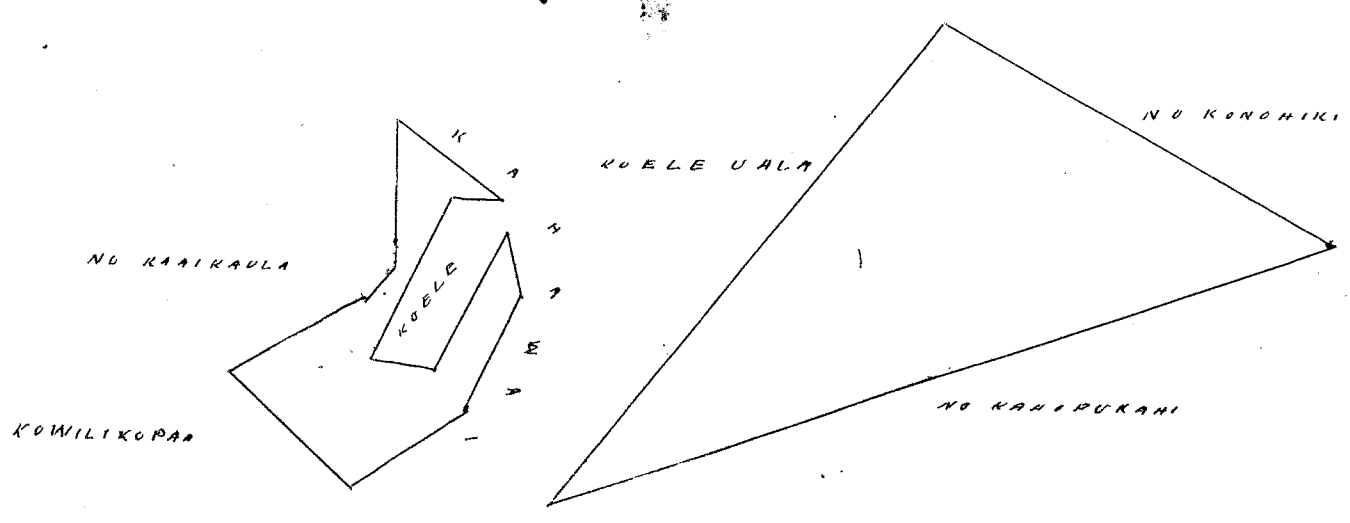

A. Bishop,
Mea ana,

Uku Pau Loa # 5
 W. L. Lee
 G. M. Robertson
 W. Smith
 J. Kekaulahao

Honolulu 15 Sep 1852.

Kolu 4612 Pala

Honoulimahu Motokai

Apana 1. Moakala, Kaipumakole, Honoulimahu, Motokai.
 E hoomaka ma ke Pihikoma, e hulu ana, Ak. 50° Kom i 200 Kh, ma ka pali; Malaila aku, Ak. 50° Kom i 130 Kh, ma Kahawai; Malaila aku, Kom. 60° Kom i 0.70 Kh, ma ka pali; Ak. 18 1/100 Kh huinaha.

Apana 2. He man Iri ma Kaipumakole.
 E hoomaka ma ke Pihikoma, Hema, e hulu ana, Ak. 12° Kom i 260 Kh, ma ka pali; Malaila aku, Kom. 18°; Hiki i 160 Kh, ma Kahawai; Malaila aku, Kom. 67° Kom. i 0.30 Kh, ma ke Kolu; Malaila aku, Kom. 20 1/2°; Hiki i 0.65 Kh, ma ke Kolu; Malaila aku, Ak. 48 1/2°; Hiki i 0.30 Kh, ma ka pali; Malaila aku, Kom. 20°; Hiki i 100 Kh, ma ka pali; Malaila aku, Kom. 87° Kom i 1.20 Kh, a hiki i ka hoomaka ana, Ak. 2 Kh, huinaha, Pau loa, 3 5/100 Kh, huinaha.

A. Bishop,
 Mea ana,

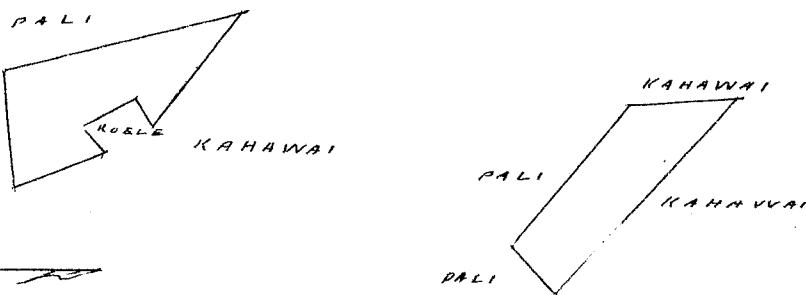

Uku Pau Loa # 4.
 W. L. Lee
 G. M. Robertson
 W. Smith
 J. Kekaulahao

Honolulu 15 Sep 1852

Kolu 4557 Waihowale

Kepuka 2 Motokai

Waihowale, Kaubini, Avilina

Apana 1. He Moakala, C Makahia 1, Kepuka 2, Motokai.
 E hoomaka ma ke Pihikoma, e hulu ana, Ak. 56°; Hiki i 0.55 Kh, ma Moakala; Malaila aku, Ak. 55° Kom. i 4.00 Kh, ma Kahawai; Malaila aku, Kom. 56° Kom i 0.55 Kh, ma ke Kolu; Malaila aku, Kom. 55°; Hiki i 4.00 Kh, a hiki i ka hoomaka ana.

Apana 2. He Moakala ma Makahia 1.
 E hoomaka ma ke Pihikoma, e hulu ana, Ak. 55°; Hiki i 1.39 Kh, ma Kahawai; Malaila aku, Kom. 86°; Hiki i 0.60 Kh, ma Kahawai; Malaila aku, Kom. 5°; Hiki i 0.56 Kh, ma ke Kolu; Malaila aku, Ak. 88°; Hiki i 0.66 Kh, ma Kahawai; Malaila aku, Ak. 88°; Hiki i 0.46 Kh, ma ke Kolu; Malaila aku, Kom. 73 1/2°; Hiki i 1.20 Kh, ma Kahawai; Malaila aku, Kom. 84° Kom. i 3.60 Kh, ma ka pali; a ka hoomaka ana, 1 2/100 Kh, huinaha, Pau loa 3 36/100 Kh, huinaha.

A. Bishop,
 Mea ana,

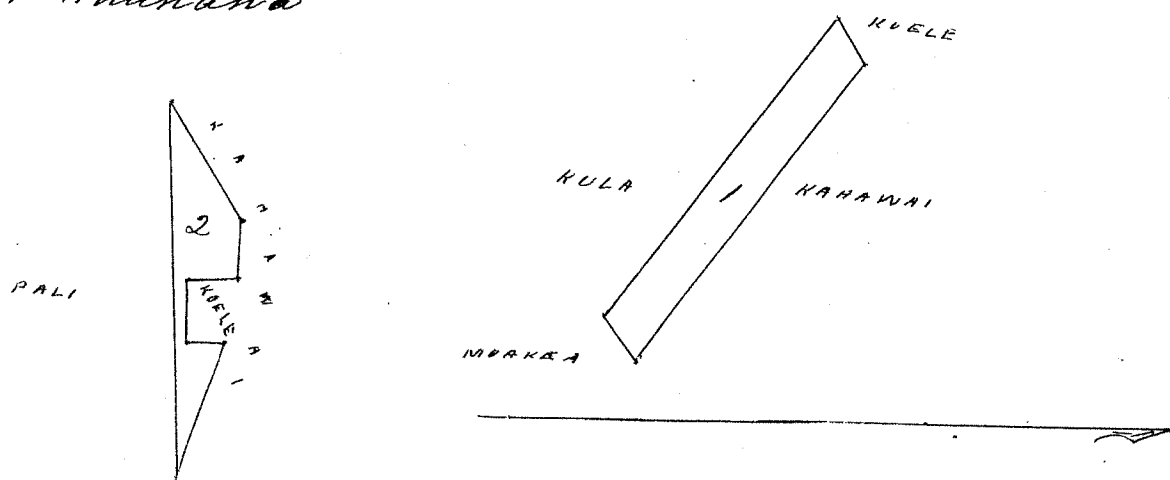

Wm. Pan Loaf
W. L. Lee
G. M. Robertson
W. Smith
J. Kekaulaao

Honolulu 15 Sep 1852.

Helu 4926 Kuapa

Koepuka, I. Molokai.

Moosaina, Keahua I, Koepuka I, Molokai;
E hoomaka ma Ke Kahi Kikina, Akau, e hulu ana, Kom. 44, Kom i 0,90 Kk. ma ka
palea Koke, Malaila aku, Kom. 46, Kike i 0,64 Kk. Malaila aku, Kom 2 1/2, Kike i
0,50 Kk. Malaila aku, Kom. 6 1/2, Kom i 0,77 Kk. ma Ke Koke, Malaila aku,
Ak. 29, Kom i 2,30 Kk. ma Kula o Konohiki, Malaila aku, Kom. 6 1/2, Kike i 0,66
Kk. ma Ke Koke, Malaila aku, Ak. 28, Kike i 0,50 Kk. ma Ke Koke, Malaila
aku, Ak. 56, Kom i 1,17 Kk. ma Ke Koke, Malaila aku, Kom. 35, Kom i 0,64
Kk. Malaila aku, Kom. 57, Kike i 0,60 Kk. Malaila aku, Kom. 55, Kom i 1,18
Kk. Malaila aku, Ak. 53, Kom i 2,40 Kk. ma Ke pali, Malaila aku, Ak.
27, Kom i 2,60 Kk. Malaila aku, Ak. 3, Kom i 1,18 Kk. ma Ke pali, Mal-
aila aku, Kom 44 Kike 7,20 Kk. ma Konohiki; a Ke hoomaka ana, Ke Koke,

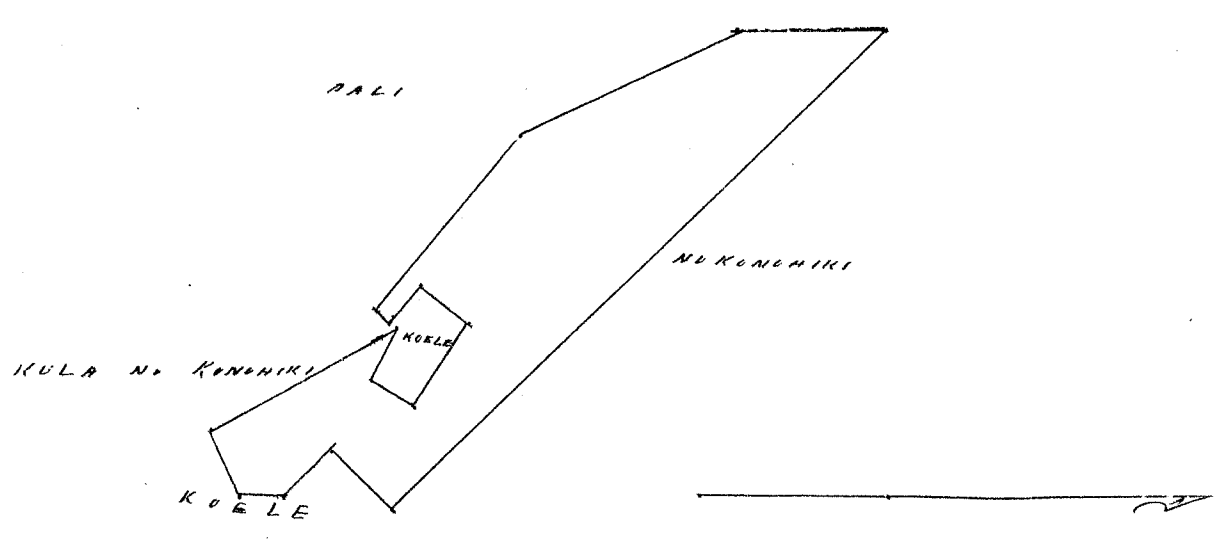

A. Bishop
Ke ana,

Wm. Pan Loaf
W. L. Lee
G. M. Robertson
W. Smith
J. Kekaulaao

Honolulu 15 Sep 1852.

Helu 4902 Keekahuna

Koepuka, I. Molokai.

Moosaina, Kamakaula, Koepuka I, Molokai;
E hoomaka ma Ke Kahi Akau, e hulu ana, Kom. 19 1/2, Kom i 0,70 Kk. ma Ke
palea no Kuapa, Malaila aku, Kom. 63, Kike i 4,84 Kk. ma Kula o Konohiki
Malaila aku, Kom. 18 1/2, Kike i 4,60 Kk. ma Kula o Konohiki Malaila aku,
Kom 75 1/2, Kike i 3,70 Kk. malaila aku, Ak. 10, Kom i 2,44 Kk. ma Kula o
Konohiki, Malaila aku, Kom. 86, Kom i 1,64 Kk. Malaila aku, Ak. 22,
Kom i 4,78 Kk. ma Kula o Konohiki, Malaila aku, Ak. 72, Kom i 5,40 Kk.
a hiki i Ke hoomaka ana, Ke 18 1/2 o Kea,

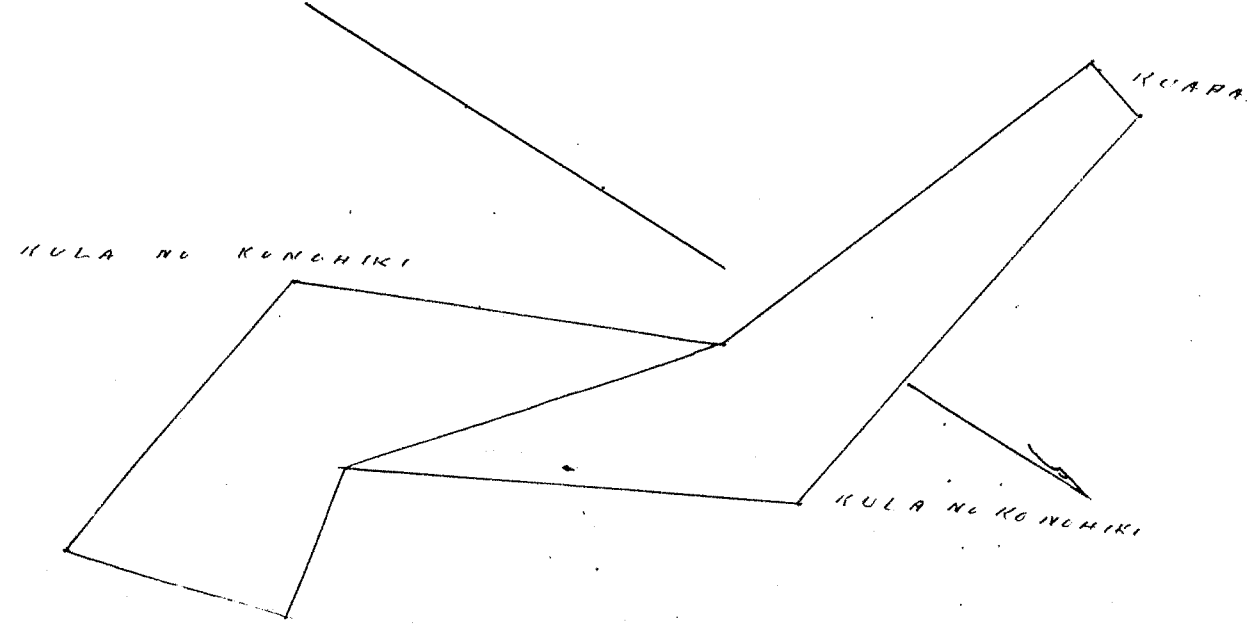

A. Bishop
Ke ana,

Wku Pau Loa 1

W. L. Lee
G. M. Robertson

W. Smith

J. Kekaulahao

Honolulu 15 Sep 1852

Kelu 4912. Kaniaw Kaholokahiki Hoouina

Kepuka 1 Molokai

He Kula ma Puna, Kepuka 1, Molokai;
E hoomaka ma ke pihiki Akau, e huli ana, Hem. 8°; Hiki i 540 Kk. ma ka palena ma
Kouhiki; Malaila aku, Hem. 68°; Kom i 8.10 Kk. ma ka Kouhiki; Malaila aku, Ak. 26°;
Kom i 260 Kk. Malaila aku, Ak. 51°; Hiki i 950 Kk. a hiki i ka hoomaka ana,
He 3, 2/10 na Eka,

Apuna 2, He Kula: Puna, Kepuka 1
E hoomaka ma ke pihiki Kikina e huli ana, Ak. 29°; Kom i 4.05 Kk. ma ka Alanui
Malaila aku, Hem. 61°; Kom i 6.12 Kk. ma ka Kouhiki; Malaila aku, Hem. 29°;
Hiki i 288 Kk. Malaila aku, Ak. 67 1/2°; Hiki i 6.00 Kk. a hiki i ka hoomaka
ana, He 2, Eka, Pau loa, 5 2/10 na Eka.

A. Bishop
Mea ana

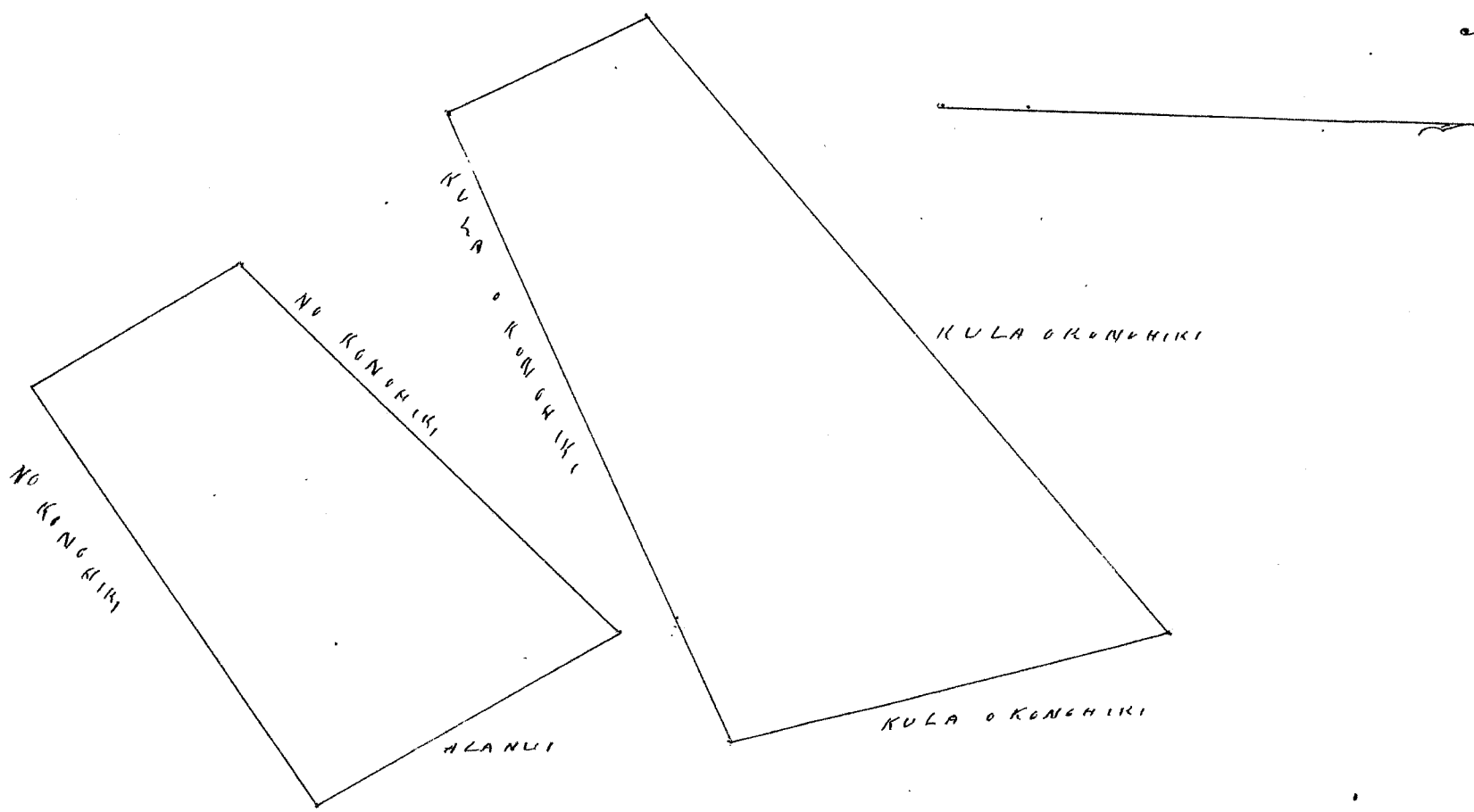

Wku Pau Loa 7

W. L. Lee
G. M. Robertson

W. Smith

J. Kekaulahao

Honolulu 15 Sep 1852

Kelu 3921. Nalii

Kepuka 1 Molokai

Moaina o Kaluanui, Kepuka 1, Molokai;
E hoomaka ma ke pihiki Hiki, Akau, e huli ana, Hem. 3°; Kom i 2.24 Kk. ma ka pali;
Malaila aku, Ak. 81°; Kom i 360 Kk. ma ka pali; Malaila aku, Hem. 52°; Kom i 1.60 Kk.
ma Kouhiki; Malaila aku, Ak. 25°; Kom i 5.18 Kk. ma ka Kapuia, Malaila aku
Ak. 37 1/2°; Kom i 2.16 Kk. ma ka pali; Malaila aku, Hem. 50°; Hiki i 9.40 Kk. a hiki i ka hooma-
ka ana, He 2 13/100 Eka,

Apuna 2, He Kula: Kaluanui, Kepuka 1.
E hoomaka ma ke pihiki Kouhiana Hema, e huli ana, Hem. 78°; Hiki i 4.00 Kk. ma Puna
o Kouhiki; Malaila aku, Ak. 4 1/2°, Kom i 8 35/100 Kk. Malaila aku, Ak. 86°; Kom i 2.80
Kk. ma ka pali; Malaila aku, Hem. 4°; Kom i 7.84 Kk. a hiki i ka hoomaka ana
He 2 66/100 Eka, Pau loa, 4 77/100 na Eka,

A. Bishop Mea ana

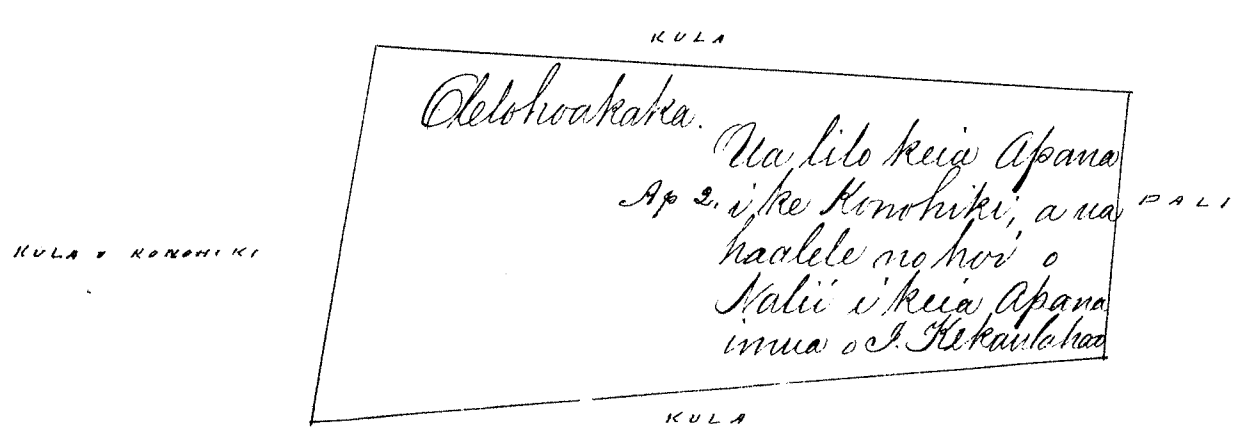
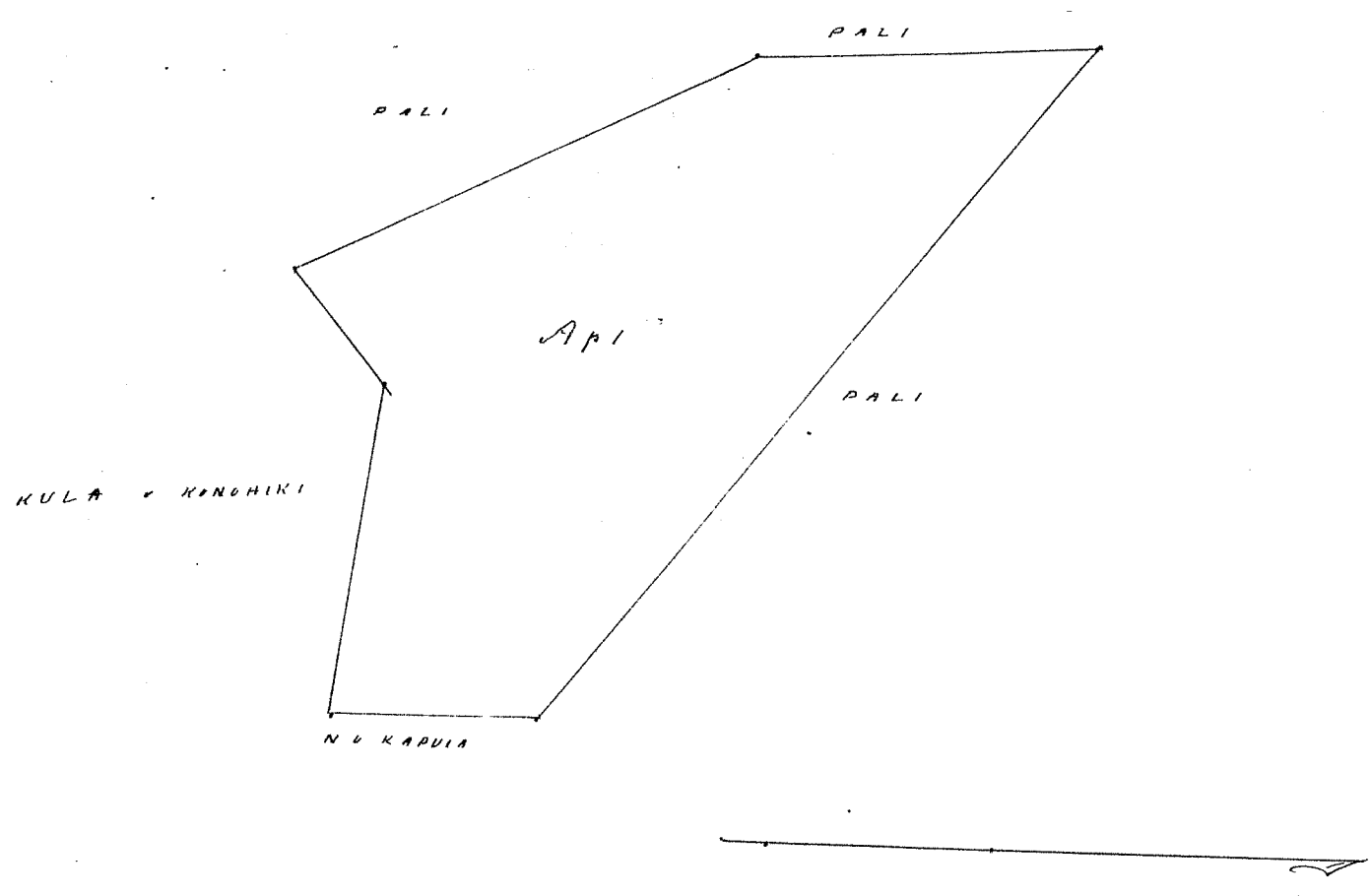

Wm. P. Lee
 W. L. Lee
 G. M. Robertson
 W. Smith
 J. Kakaulehee

Honolulu Oahu 25 Sep 1852

Heleu 1903 Kanakaole

Kupuka 1 Molokai

He Pula i loko o Kaholopee, Kupuka, 1. Molokai,
 E hromaka ana ke Kiki Kiki. Numa, e hulu ana, Ak. 22; Kiki i 210 Kh. ma ke alama;
 Mataila akua, Ak. 32 1/2; Num. 217 Kh. e Mataila akua, Num. 6 1/2 Num. 14.00 Kh.
 ma ke palama no Kaniaw e Mataila akua, Num. 20; Kiki i 5.40 Kh. ma ke Konoiki
 Mataila akua, Ak. 60; Kiki i 11.40 Kh. ma ke Konoiki, a ke hromaka ana,
 ke 5 85/100 E ka

A. Bishop,
 Inua ana,

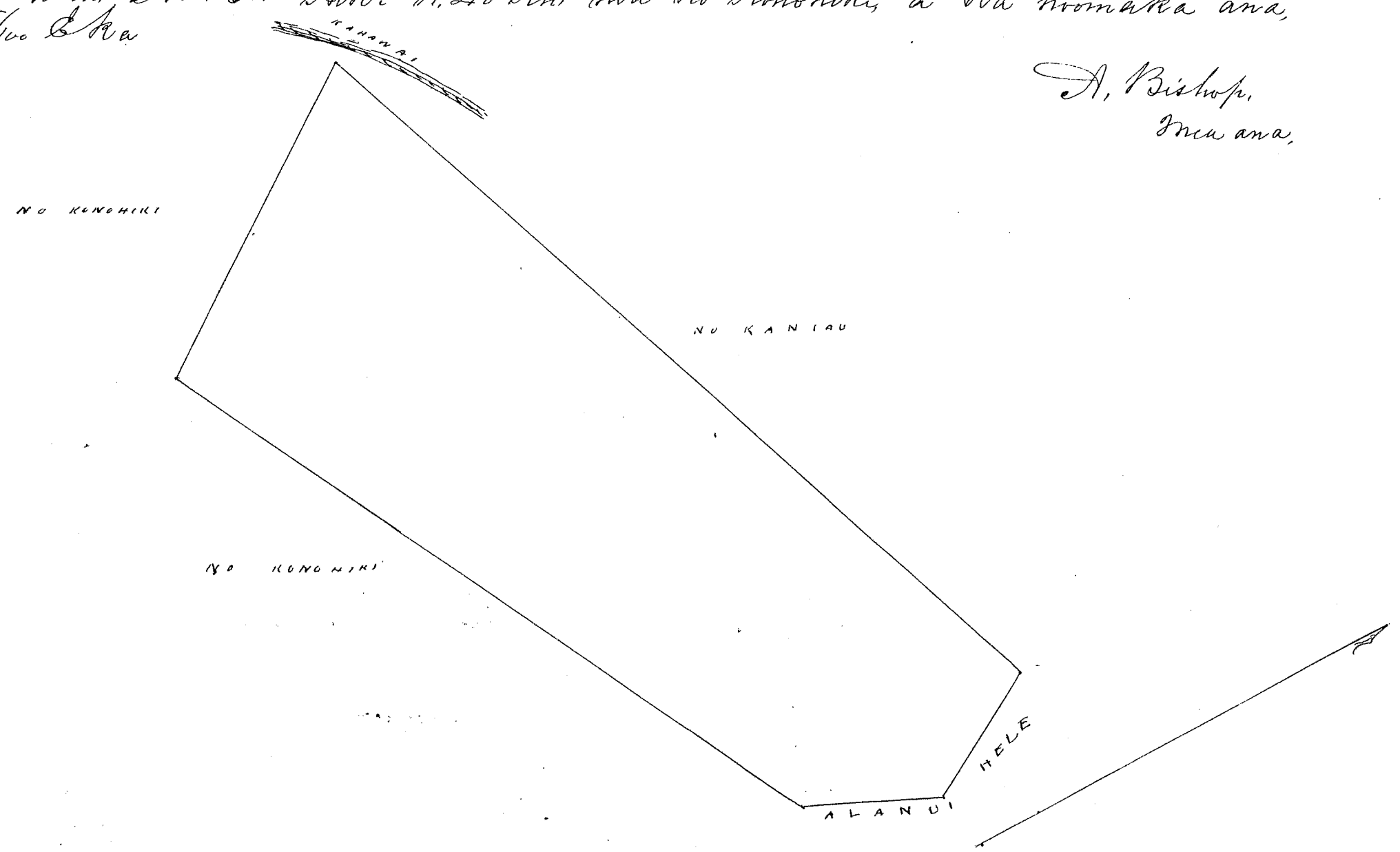

Wm Pau loa \$ 7.
W. L. Lee
G. M. Robertson
W. Smith
J. Kekaulahao

Honolulu 15 Sep 1852

Walu 4758 Naki

Pohakupili, Molokai

Apana 1. Ke Kula ma Palaha, Pohakupili, Molokai.
E hoomaka ma ke Pihii, Komohana, e hili ana, Ak. 86 1/2° Niki 5.50 Kh. ma ka arao pali,
Mabaita aku, Ak. 75° Niki 2.83 Kh. Mabaita aku, Ak. 5° Niki 0.63 Kh. Mabaita aku,
Ak. 67° Kom. i 700 Kh. Mabaita aku, Kom. 24° Kom. i 1.12 Kh. a ka hoomaka ana, Ke
2 1/100 Eka,

Apana 2. Ke mo aiwa ma Palaha.
E hoomaka ma ke Pihii, Niki. Akau, e hili ana, Kom. i 150 Kh. ma kumu pali, Mabaita
aku, Ak. 56 1/2° Kom. i 1.95 Kh. Mabaita aku, Kom. 34 1/2° Kom. i 2.80 Kh. ma ka pali,
Mabaita aku, Ak. 20° Kom. i 2.50 Kh. e Mabaita aku, Ak. 7° Niki, i 1.98 Kh. ma ka
pali, Mabaita aku, Kom. 60° Niki i 1.81 Kh. ma ka palina mo eka, Mabaita aku,
Kom. 71° Niki, i 2.38 Kh. a ka hoomaka ana, Ke 0 86/100 Eka.
Pau loa. Ke 2, 9 1/100 Eka.

A. Bishop
mea ana.

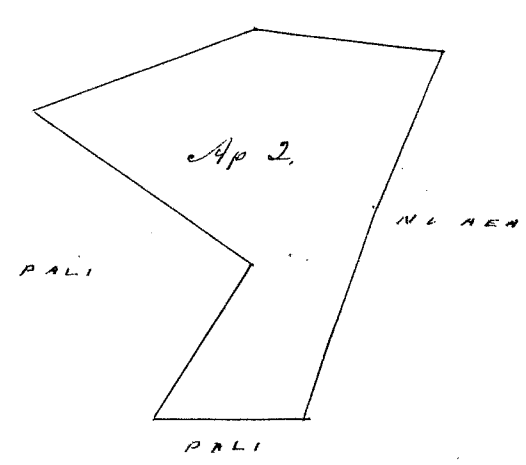
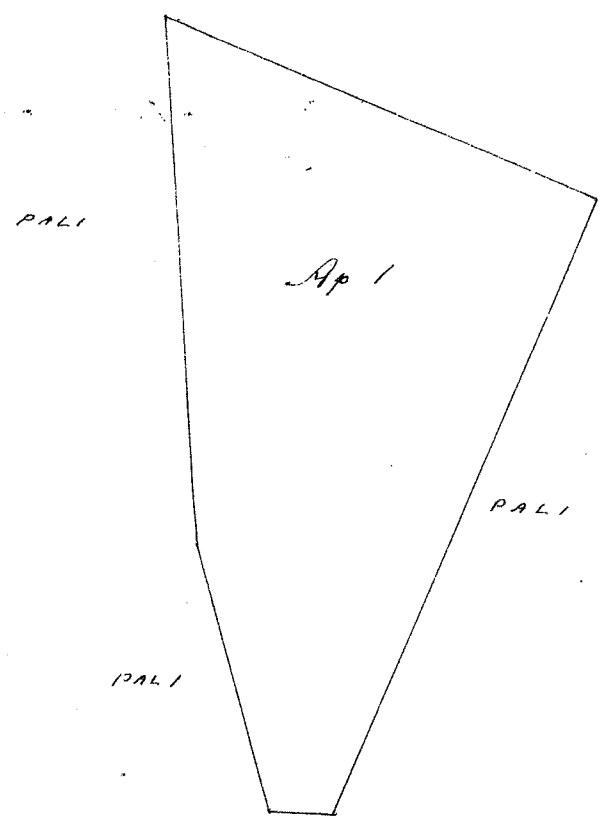

Wm Pau loa \$ 5.
W. L. Lee
G. M. Robertson
W. Smith
J. Kekaulahao

Honolulu 15 Sep 1852.

Volu 4686 Soanui 5977 Moakea & Pohakupili Molokai.

Apawa 1. Ke Mo i Kukuiimalu, Moakea, Molokai, E hoomaka ma ke Pihik Komohana, e hulu ana, Dem. 55° Niki: 0.35 Kh. Malaila aku, Aka 14° Kh. ma Kahawai, Malaila aku, Ak. 2° Niki: 0.6 Kh. ma Kahawai, Malaila aku, Dem. 32° Kom: 02, 00 Kh. ma Kapali, a hiki: Ke hoomaka ana, Ke 0, 63/100 Kh. huinaha

Apawa 2, Ke pahale ma Pohakupili Molokai. E hoomaka ma ke Pihik Nika-Nema, e hulu ana, Ak. 20° Niki: 1.50 Kh. ma Kahawai, Malaila aku, Ak. 78° Kom: 2.00 Kh. ma Kahawai, Malaila aku, Dem. 13° Niki: 1.84 Kh. ma Kapali. Paele, Malaila aku, Dem. 84° Niki: 1.60 Kh. ma Kapali, Ke 2 23/100 Kh. huinaha

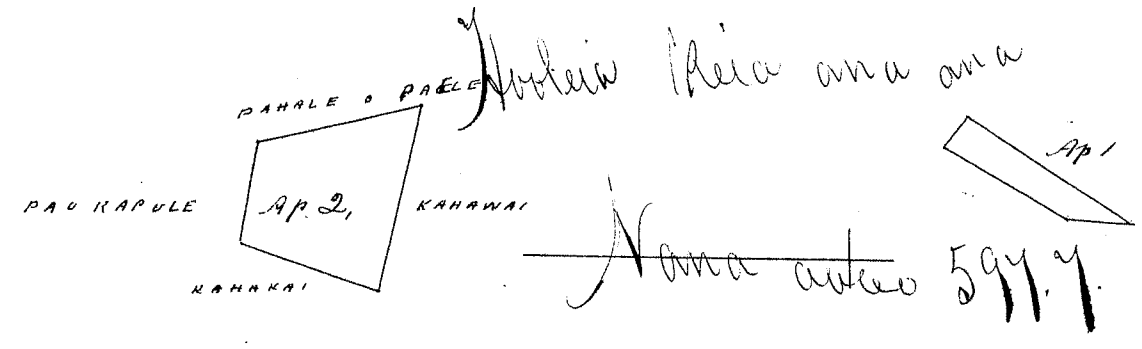

A Bishop
ma ana

Mrn Pau Loa A
N. L. Lee
G. M. Robertson
St. Smith

Honolulu 15 Sep 1852.

Volu 4900 Tahuliaikaua 66013 Moakea Molokai.

Moraina o Kapunia Moakea, Molokai. E hoomaka ma ke Pihik Aka, e hulu ana, Dem. 76 1/2° Kom: 1.50 Kh. ma Kapali ma Kawahine, Malaila aku, Dem. 2 1/2° Kom: 2.00 Kh. ma Kula o Konoiki, Malaila aku, Dem. 36° Kom: 1.16 Kh. Malaila aku, Ak. 78° Kom: 0.65 Kh. ma Kapali, Malaila aku, Dem. 37° Kom: 2.10 Kh. ma Kapali, Malaila aku, Dem. 88° Kom: 1.90 Kh. Malaila aku, Dem. 4 1/2° Niki: 2.00 Kh. ma Kula o Konoiki, Malaila aku, Ak. 84° Niki: 3.16 Kh. ma Ke Konoiki, Malaila aku, Ak. 6° Niki: 0.60 Kh. ma Kahawai, Malaila aku, Dem. 79° Kom: 0.50 Kh. ma Ke Kooli, Malaila aku, Ak. 8 1/2° Kom: 0.40 Kh. Malaila aku, Ak. 64° Niki: 0.65 Kh. ma Ke Kooli, Malaila aku, Ak. 31° Niki: 1.03 Kh. ma Ke Kooli, Malaila aku, Dem. 88° Niki: 0.54 Kh. Malaila aku, Dem. 34° Niki: 1.00 Kh. ma Ke Kooli, Malaila aku, Ak. 13° Niki: 4.10 Kh. a hiki: Ke hoomaka ana, Ke 1 2 1/100 Eka.

Apawa 2 Ke mau lvi i loko o Kapunia. E hoomaka ma ke Pihik Komohana, e hulu ana, Ak. 82° Niki: 0.33 Kh. ma Kapali Kooli, Malaila aku, Dem. 30° Niki: 1.37 Kh. ma Kahawai, Malaila aku, Dem. 40° Kom: 0.73 Kh. ma Kahawai, Malaila aku, Ak. 62° Kom: 1.70 Kh. ma Kahawai, Malaila aku, Ak. 25° Niki: 1.30 Kh. a hiki: Ke hoomaka ana, Ke 1.87/100 Kh. huinaha.

Apawa 3, Ke Kula ma Kapunia, Moakea. E hoomaka ma ke Pihik Aka, e hulu ana, Dem. 54° Kom: 8.40 Kh. ma Kapali, Malaila aku, Dem. 35° Kom: 11.50 Kh. ma Ke Konoiki, Malaila aku, Dem. 87° Niki: 5.50 Kh. Malaila aku, Ak. 34 1/2° Niki: 10.50 Kh. ma Ke Konoiki, Malaila aku, Ak. 16 Niki: 6.20 Kh. a hiki: Ke hoomaka ana, Ke 6 4/100 ma Eka, Pau loa 7 85/100 ma Eka.

A Bishop
ma ana

1.21 E
18.4.87 K
4.32 P
5.89 E 148.

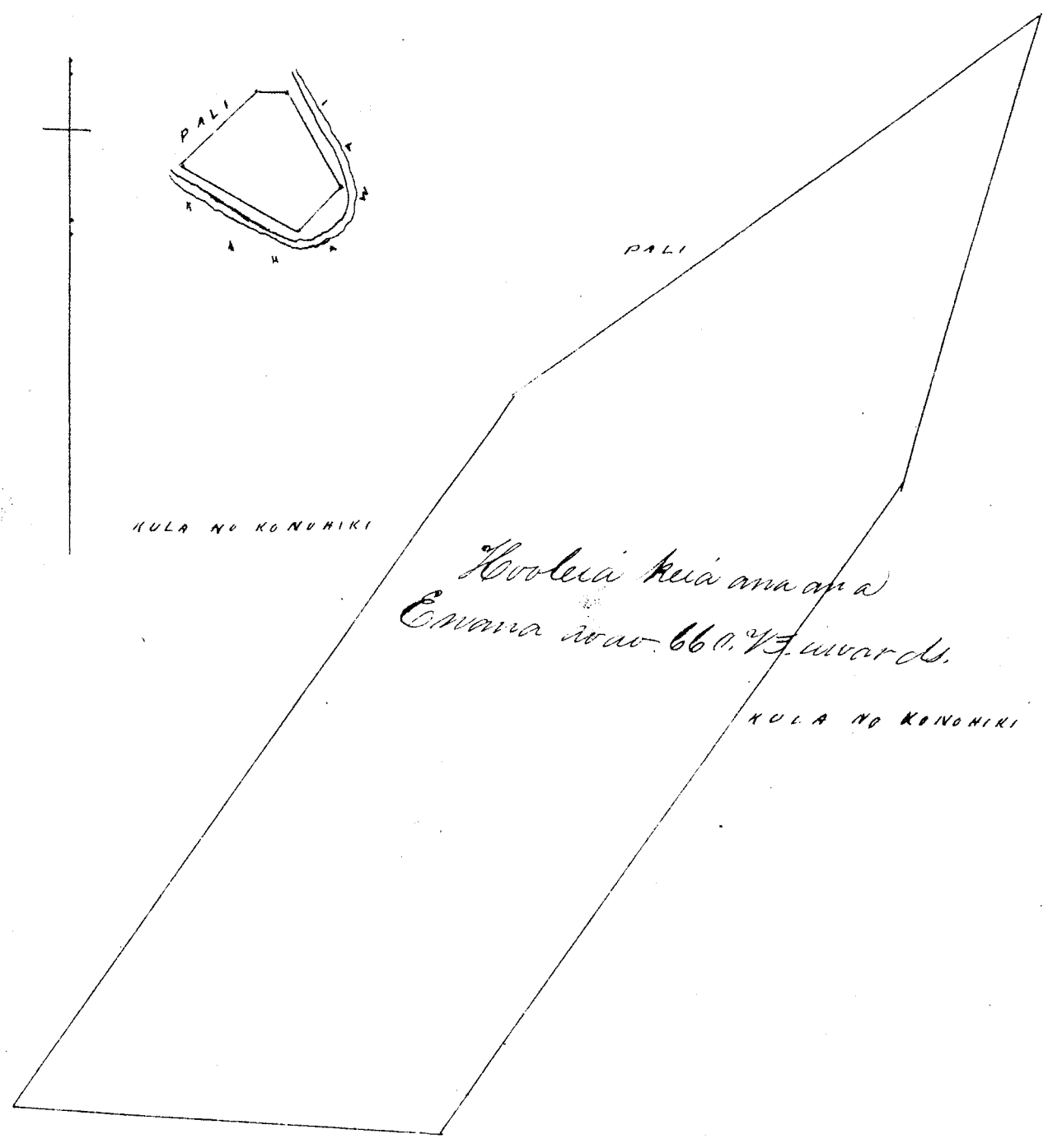
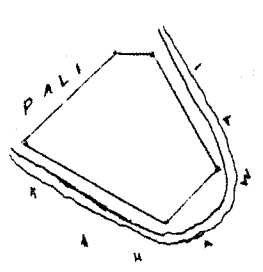
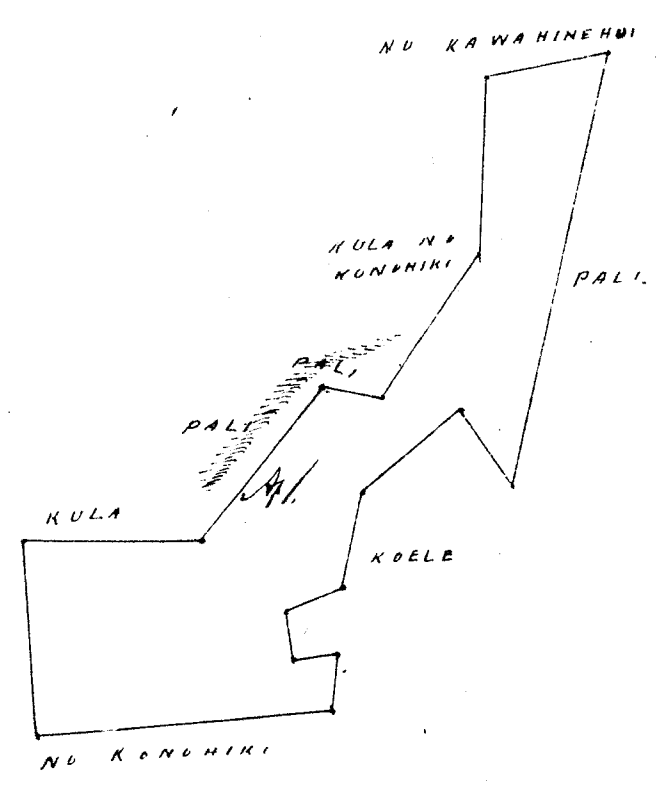

Wku Pau Low \$3.00
M. L. Lee
G. M. Robertson
J. M. Smith
J. Sekaulahao

Honolulu 15 Sep 1852

Volu 4536 Clemakule ✓ + 6600 Moakea, Molokai,

Clemakule, make, Kuleapu, Avoilina.
Apana 1. Moaia Palauhulu, Moakea, Molokai.
E hoomaka ana ke Pihiki Aka, e huli ana, Hem. 47; hiki i 6.54 Kh. ma ke Kule,
Malaila aku, Hem. 66. Kom i 118 Kh. ma Kula. Konoiki; Malaila aku, Hem 19 1/2.
hiki: 0.26 Kh. ma ke Kule, Malaila aku, Hem. 76 1/2. Kom i 0.55 Kh. Malaila aku,
Hem. 6; hiki: 0.33 Kh. Malaila aku, Hem. 7 1/2. Kom i 530 Kh. ma ke Kumu pali,
Malaila aku, Ak. 10; hiki: 160 Kh. Malaila aku, Ak. 80; hiki: 1.63 Kh. ma ke
Kula. Konoiki; a ka hoomaka ana, ke 78/100 e ka Eka,

Apana 2. Ke Pula ma Palauhulu, e Moakea,
E hoomaka ana ke Pihiki Kikina, e huli ana, Hem. 18 1/2 Kom i 7.53 Kh. ma Kula ma
Konoiki, Malaila aku, Ak. 59; Kom i 9.10 Kh. Malaila aku, Ak. 5; hiki i 8.80
Kh. ma Kula, Malaila aku, Hem. 56; hiki i 11.10 Kh. ma ka palina ma Kaka-
wa, a hiki i ka hoomaka ana, ke 75 1/2/100 ma Eka.

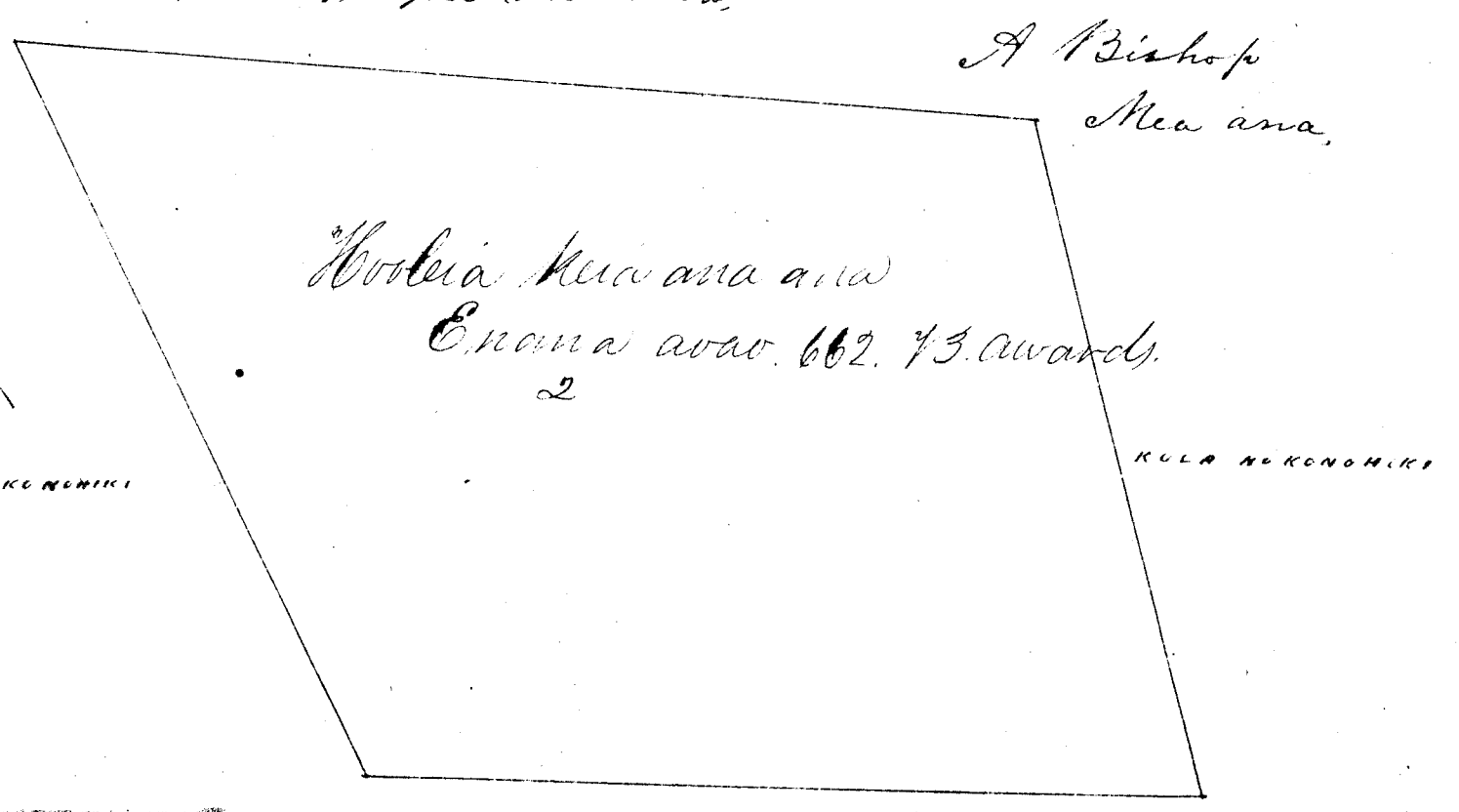
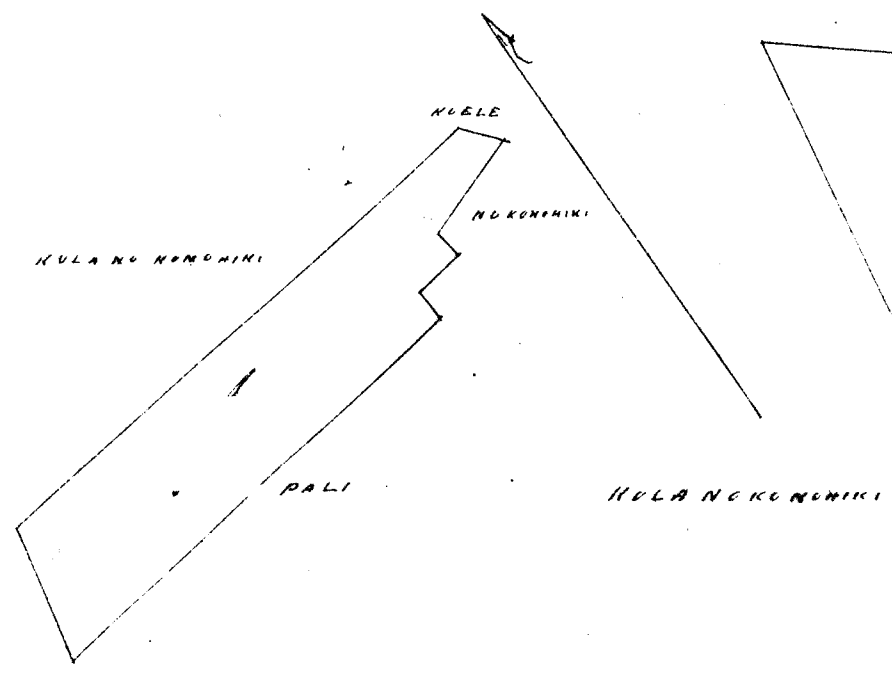

A Bishop
Mea ana,

Wku Pau Loa \$ 3.00
W. L. Lee
G. M. Robertson
J. Hekeaulakao
J. H. Smith

Honolulu 15. Sep. 1852.

Heleu 6639 Sakaina or Kouli Lufehu Molokai.

Apana 1. Ke Kula, owa Pohaku o Kauhale, or Piiri Lufehu Molokai.
E hoomaka ma ke Kihikihikina, e hili ana, Ak. 4, Niki i 322, Kh. ma ke Kihikihikina, Malaila
aku, Niki i 1,00 Kh. Malaila aku, Nemi 76 1/2, Niki i 2,92 Kh. ma ke Kihikihikina, Malaila
aku, Nemi 5, Nemi i 2,20 Kh. ma ke ala o Kupuni, Malaila aku, Ak. 86 1/2, Nemi i 788 Kh. ma
ke ala o Honolulu, Ke Kauhale, Malaila aku, Nemi 56, Nemi i 6,00 Kh. Malaila
aku, Ak. 24, Nemi i 5,54 Kh. ma ke Kauhale, i Honolulu, Malaila aku, Ak.
88, Nemi i 1,75 Kh. a hiki i Ke hoomaka ana, Ke 5.86/100 Eka,

Apana 2. Ke Pahale ma Lufehu.
E hoomaka ma ke Kihikihikina, ma ke ala i Kauhale, e hili ana, Ak. 72, Nemi i
4,10 Kh. ma Kauhale, Malaila aku, Nemi 50, Nemi i 337 Kh. ma ke Pahale.
Kauhale, Malaila aku, Nemi 26, Nemi i 2,41 Kh. ma ke Pahale Kula, Malaila aku,
Nemi 72, Niki i 2,52 Kh. Malaila aku, Ak. 55, Niki i 6,40 Kh. ma Kauhale, a ke
hoomaka ana, Ke Eka, 1.86/100.

Apana 3. Ke Mooko, Piiri, Lufehu.
E hoomaka ma ke Kihikihikina, e hili ana, Nemi 43, Nemi i 3,40 Kh. ma ke Pali.
Malaila aku, Ak. 88, Niki i 1,56 Kh. ma Kauhale, Malaila aku, Nemi i 0,52
Kh. ma ke Kouli, Malaila aku, Niki i 0,50 Kh. Malaila aku, Nemi 6, Niki i
0,60 Kh. Malaila aku, Ak. 65, Niki i 2,16 Kh. ma Kauhale, Malaila aku,
Ak. 28, Nemi i 2,42 Kh. ma ke Pali, a hiki i Ke hoomaka ana, Ke 0.26/100 Eka
Pau loa, } Eka, owa 18/100

A. Bishop
Ma ana

5.86
1.86
46
8-18

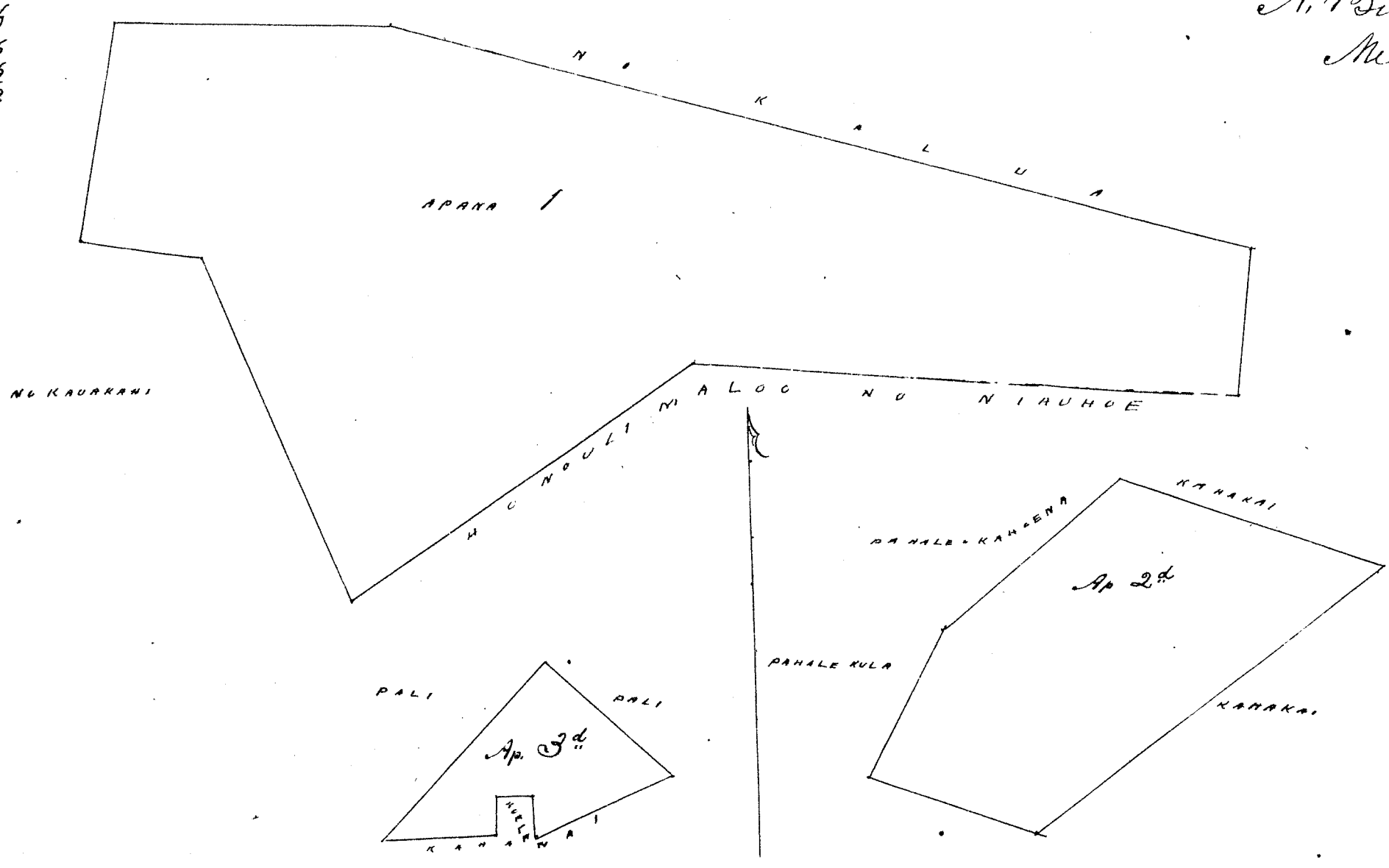

Wku Pau Loa \$ 7
W. L. Lee
G. M. Robertson
J. Hekeaulakao
J. H. Smith

Honolulu, 15. Sep. 1852.

Hulu 4200 Kaahouena

Moakea Molokai.

Chua mau Ioi'loko o Manapai, Moakea, Molokai, E hoomaka ma ke kiki Hikina, e hiki ana, Hem. 72° Kom i 104 Kh, ma ka palena Kula, Mataila aku, Ak. 14° Kom i 130. Kh, ma ka palena Kula, Mataila aku, Hem. 56 Hiki i 160 Kh, ma Kahawai, a hiki i ka hoomaka ana, ke 5/100 Kh huinaha.

A. Bishop
Mea ana

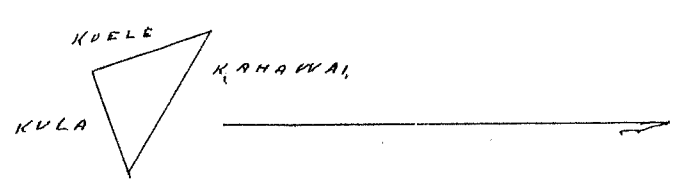

Wku Pau Loa & L
W. L. Lee
G. M. Robertson
J. Kaulahao
J. H. Smith

Honolulu 15 Sep 1852

Hulu 3019 Mehao

Waikapu Maui.

Mehao, - O Mumuku ka hoilina Waikapu, Maui.

Apana 1. Ioi' ma Ohia, E hoomaka ma ke Kahawai, kiki Hikina, e hiki ana ma ke Kaulamakule, a e holo, Ak. 38 3/4° Kom 265 Kh, ma ke Kaulamakule, Ak. 26 1/2° Kom 173 Kh, ma ke Kaulamakule, Hem. 73° Kom. 86 Kh, ma ke Manu, Hem. 5 1/2° Hiki 117 Kh, ma ke Pipinui, Hem. 15° Kom 71°, ma ke Pipinui, Hem. 88° Hiki 122 Kh, ma ke Poalima, Hem. 14° Kom 110 Kh, ma ke Poalima, Hem. 7 1/2° Hiki 194 Kh, ma ke Kahawai, Ak. 53 1/2° Hiki 83 Kh. a puni, 5 3/100 Eka.

Apana 2. Pahala, ma Pipinui. E hoomaka ma ke kiki Hem. a e holo, Ak. 13° Hiki i 158 Kh, ma ke Kula, Ak. 77° Kom. 158 Kh, ma ke Kula, Hem. 13° Kom. 158 Kh, ma ke Kula, Hem. 77° Hiki 158 Kh. a puni, - 1/4 Eka.

Apana 3. Ua huiia me ke Kuleiaiku,
Wailuku, Aug, 27, 1852.

C. Bailey
Mea ana aina.

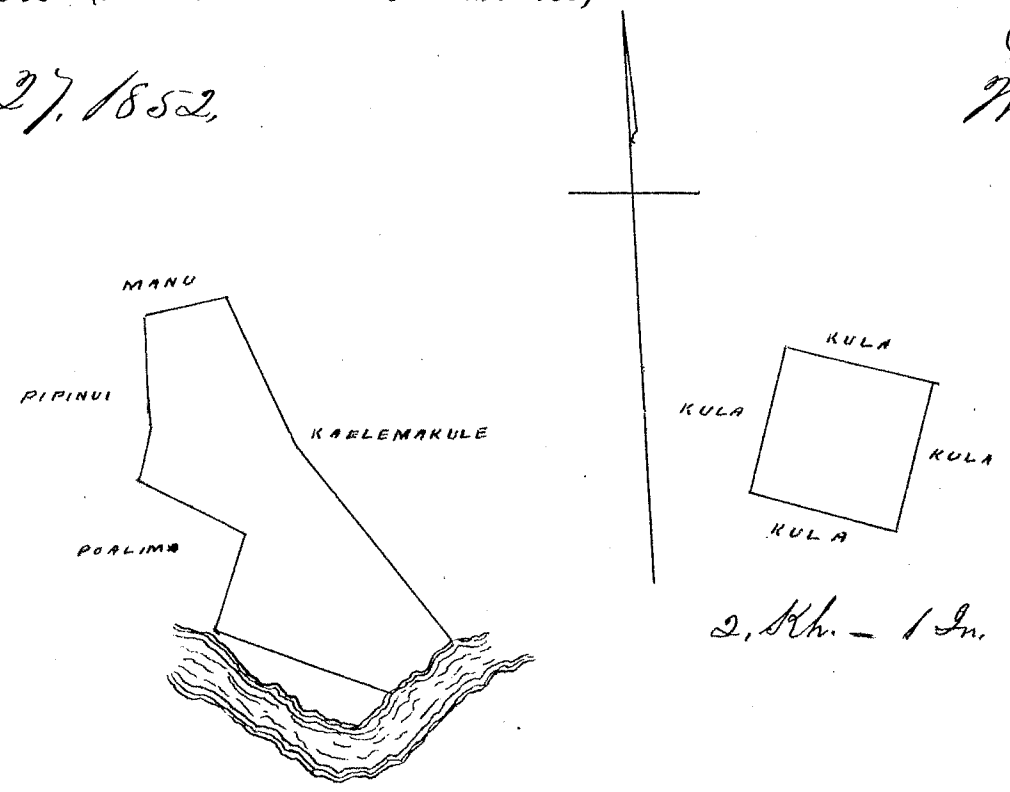

Wku Pau Loa & L
W. L. Lee
G. M. Robertson
J. Kaulahao
J. H. Smith

Honolulu, 27 Sep, 1852.

Kulu 3397 Pihī () Waikapu, Maui.

Apāna 1 & 2. Pahale me Kala, ma Kaopala E hoʻomaka ma ke kīhi Hem. a e holo, Ak. 36° Nīk 229 Kū, ma ko C. Copp, Ak. 8° Nīk 110 Kū, ma ko C. Copp. Hem. 4 1/2; Ko. 131 Kū, ma ko Kalahouka, Ak. 60 1/2; Kū. 50 Kū, ma ko Kalahouka, Ak. 25 1/2; Nīk. 70. Kū, ma ko Kalahouka, Ak. 54 1/2; Kū 190 Kū, ma ko Kalahouka, Ak. 24 1/2; Ko. 97 Kū, ma ka Poalima, Ak. 71° Ko 58 Kū, ma ka Poalima; Kū. 21; Ko. 2,00 ma Kamakai, &c. Hem. 2 1/2 Nīk. 306 Kū, ma ko Kalahouka, a hiki ma kahi i hoʻomaka i - 84/100 Eka.

Apāna 3. Paakai ma Kealia, E hoʻomaka ma ke kīhi Kū, Ak. a e holo, Ak. 1° Ko 325 Kū, ma ke Aupuni, Ak. 78° Ko 6,00 Kū, ma ke Aupuni; Hem. 2° Nīk. 2,38 Kū, ma ke Aupuni, Ak. 85 1/2° Nīk. 5,85 Kū, ma ke Alanui a hiki ma ke kīhi mua, - 165/100 Eka.

Apāna 4. Paakai ma Kealia, E hoʻomaka ma ke kīhi Kū, a e holo. Ak. 5° Nīk. 864 Kū, ma ko Kahiwahu, Hem. 76° Ko. 171 Kū, ma ke Aupuni; Hem. 5° Ko 7,30 Kū, ma ko Kahuhu, Hem. 57° Nīk. 1,82 Kū, ma ke Alanui, a hiki ma ke kīhi mua, - 128/100 Eka.

Wailuku, Aug. 27, 1852.

C. Bailey,
Ma ana aina.

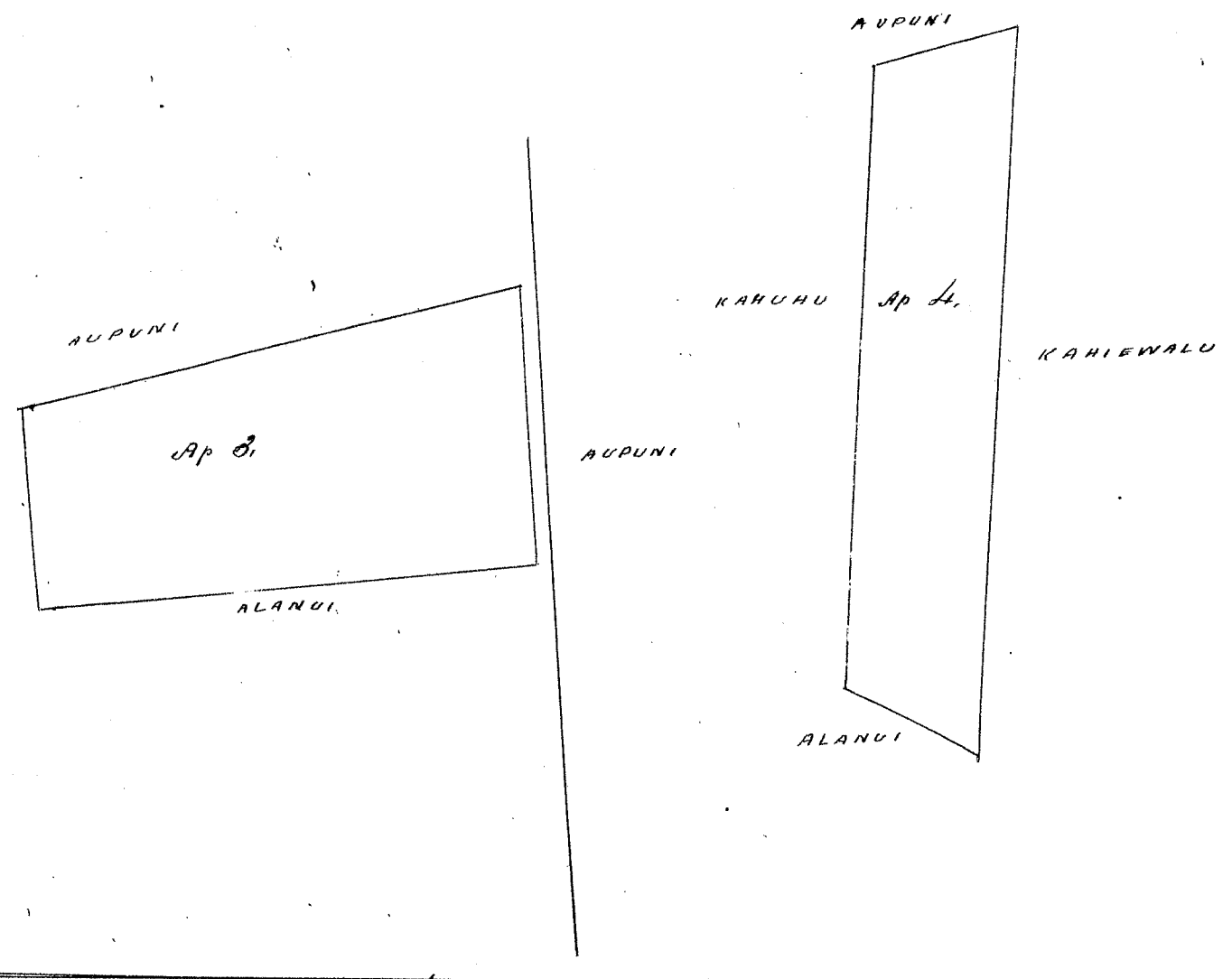
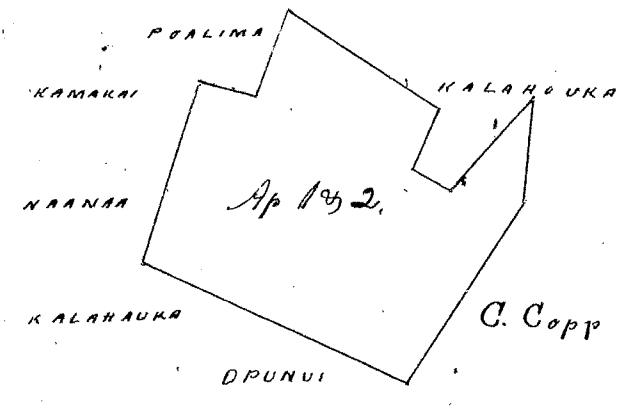
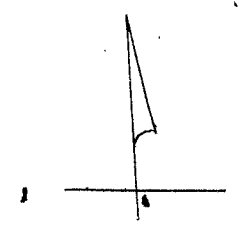

Wku Pau Loa 7

W. H. Bee
G. M. Robertson
J. H. Smith
J. Kekaulaha

Honolulu 27 Sep 1852.

Apana 1, Kalo & Kula, ma Pihoku, E hoomaka ma ke kiki Ak, e pili ana me ko Nahau, a e holo, Hem. $49\frac{1}{2}$ ° Nite. 381 Kh. e pili ana me Keawe, Hem. $62\frac{1}{2}$ ° Nite. 157 Kh. e pili ana me Keawe, He. 37 ° Kom. 178 Kh. e pili ana me Kahakumakaaui, Hem. $53\frac{3}{4}$ ° Kom. 57° Kh. e pili ana me Kahakumakaaui, Hem. $11\frac{1}{2}$ ° Kom. 155 Kh. e pili ana me Kahakumakaaui, Ak. 70 ° Ko. 24 Kh. e pili ana me Chumui, Ak. 11° Nite. 78 Kh. e pili ana me Chumui, Ak. $81\frac{1}{4}$ ° Ko. 39 Kh. e pili ana me Chumui, Ak. $10\frac{1}{2}$ ° Nite. 84 Kh. e pili ana me Chumui, Ak. $74\frac{1}{4}$ ° Kom. 198 Kh. e pili ana me Chumui, Ak. 11° Nite. $37\frac{1}{2}$ ° e pili ana i Ka Auwai, Ak. $16\frac{1}{2}$ ° Ko. 93 Kh. e pili ana i Ka Auwai, Hem. $84\frac{3}{4}$ ° Nite. 84 Kh. e pili ana me Ka Ioi Aupuni, Ak. 14° Nite. 102 Kh. e pili ana me Ka Ioi Aupuni, Hem. 80 ° Nite. 148 Kh. e pili ana me Kalawaia, Ak. $23\frac{3}{4}$ ° Nite. 196 Kh. e pili ana me Kalawaia, Ak. 75 ° Nite. 62 Kh. e pili ana me Nahau, a hiki ma kahi i hoomaka i $3\frac{1}{10}$ Eka,

Apana 2, Kalo ma Pihoku, E hoomaka ma ke kiki Nite. e pili ana me Kalawaia, a holo, Ak. $14\frac{3}{4}$ ° Ko. 300 Kh. e pili ana me Nahau, me Kahawai, Ak. 21 ° Ko. 188 Kh. e pili ana me Nahau, & Kahawai, He. 80 ° Ko. 340 Kh. e pili ana me Nahau, & Kahawai, Hem. 73 ° Ko. 154 Kh. e pili ana me Poalima, He. pono, 21 Kh. e pili ana me Kuolaia, Hem. $81\frac{1}{4}$ ° Ko. 88 Kh. e pili ana me Kuolaia, Ak. $6\frac{1}{4}$ ° Nite. 98 Kh. e pili ana me Kuolaia, Ak. 7° Nite. 97 Kh. e pili ana me Ka Poalima, Ak. $81\frac{3}{4}$ ° Ko. 135 Kh. e pili ana me Ke Kahawai, He. $8\frac{1}{4}$ ° Ko. 291 Kh. e pili ana me Kapailoi, Hem. $71\frac{3}{4}$ ° Nite. 120 Kh. e pili ana me Kaha, Hem. $83\frac{1}{2}$ ° Nite. 460 Kh. e pili ana me Ka Auwai, Hem. 73 ° Nite. 421 Kh. e pili ana me Ka Auwai, a hiki i kahi i hoomaka i $1\frac{5}{100}$ Eka,

3.90
1.56
5.46

Piipii maloke. ka Apana 2,

Apana 1, mai ke kiki Niteina o Ap. 2, e ana, Ak. 73 ° Ko. 379 Kh. & Apana pono, 29 Kh. i ke kiki Niteina, alaila holo ma ko Koa, Ak. 27 ° Nite. 65 Kh. & Ak. $65\frac{1}{2}$ ° Ko. 169 Kh. Hem. 19 ° Ko. 33 Kh. & Ak. $69\frac{1}{4}$ ° Kom. 64 Kh. Ak. 19 ° Nite. 46 Kh. & Ak. $74\frac{3}{4}$ ° Ko. 75 Kh. Hem. $19\frac{1}{2}$ ° Ko. 94 Kh. & Hem. $76\frac{1}{2}$ ° Nite. 144 Kh. Ak. $15\frac{1}{2}$ ° Nite. 38 Kh. & Hem. 71 ° Nite. 59 Kh. Hem. 13. Ko. 48. & Hem. $72\frac{3}{4}$ ° Nite. 87, a hiki ma ke kiki mua. - $\frac{1}{5}$ Eka,

Apana 2, O Piipii, E hoomaka ma ke kiki Ko, Ak. of. Koa, a e holo, Hem. $10\frac{1}{2}$ ° Nite. 58 Kh. i ke kiki mua, alaila holo, Hem. 7° Ko. 95 Kh. ma ko Melikoa, Nite. pono, 34 Kh. ma ko Melikoa, Ak. $6\frac{1}{4}$ ° Nite. 80° ma ko Melikoa, Ak. $65\frac{1}{2}$ ° Ko. 34 Kh. ma ko Melikoa, a hiki i ke kiki mua, - $\frac{3}{100}$ Eka,

Waikapu, Aug. 27, 1852

E. Bailey
Mea ana ainas

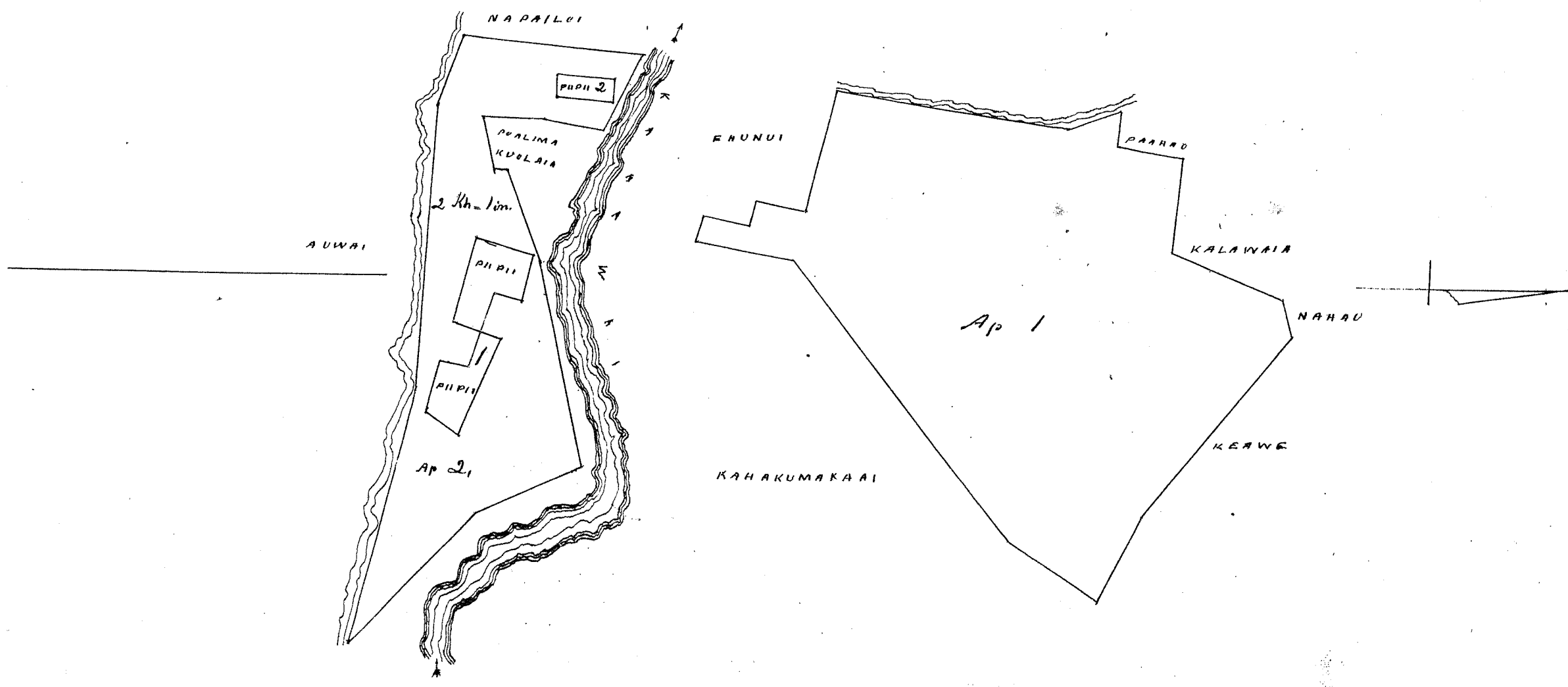

Uku Pau Loa 7

W. M. Robertson

J. H. Smith

Honolulu 27 Sep 1852

Uku 3402 Poupou

Waikapu Maui

Apana 1. & 6 Kalo & Kula ma Palama,
 Chromaka ma ka pihaku oia, kiki ho, a e holo, Ak. 55 1/2, Hike 86, Kh. e pili ana me Keaka
 Hem. 55 3/4, Hike 82, Kh. e pili ana me Kaluaninui, Hem. 80 1/2, Hike 45 Kh. e pili ana me Keaw-
 amahi, Hem. 50, Kom 45 Kh. e pili ana me Poalima, Hem. 44 1/2, Hike 75, Kh. e pili ana
 me Poalima, Ak. 72, Hike 111 Kh. e pili ana i ka Poalima, Hem. 57, Hike 134 Kh. e pili ana
 i ka Keawamahi, Hem. 42, Hike 31/4 Kh. e pili ana me Keawamahi, Hem. 26 3/4 Kom.
 176 Kh. e pili ana me Kaili, Hem. 33, Hike 25 1/4 Kh. e pili ana me Kaili, Hem. 34,
 Hike 211 Kh. e pili ana me Wahinealii, Hem. 63 1/2, Kom. 59 Kh. e pili ana me Wahinealii,
 Ak. 38 1/4, Kom. 205, Kh. e pili ana me Kaili, Ak. 61, Kom. 170 Kh. e pili ana me Kaili,
 Ak. 39, Kom. 227 Kh. e pili ana me Ke Aupuni, Ak. 27 1/2, Kom. 578 Kh. e pili ana
 me Kapule, a hiki i ke Kihimua, = 19/100 Eka,

Apana 3 Kalo ma Ohia, Chromaka ma ke Kihimua, e pili ana i Keakua
 a e holo, Ak. 24 1/2, Kom. 360, Kh. e pili ana me Keakua, Hem. 76 1/2, Kom. 58 Kh. e pili ana i
 ke Aupuni, Hem. 69, Kom. 130 Kh. e pili ana me Poalima, Hem. 19, Hike 132 Kh. e pili ana
 i ka Kaili, Ak. 28, Hike 193 Kh. e pili ana me Kaili, Ak. 86, Hike 157 Kh. e pili ana me
 Kaili, a hiki ma ke Kihimua, = 58/100 Eka,

Apana 5 & c. Ma Pahau - Pahale & Kalo, Chromaka ma ka auwai
 kiki Akau, a e holo, Hem. 32 1/2, Hike 331 Kh. e pili ana i ka pali, Ak. 71 1/2, Hike 211,
 Kh. e pili ana i ka Kapule, Ak. 34 1/2, Kom. 77, Kh. e pili ana me Keaka, Hem. 76 1/4,
 Kom. 87, Kh. e pili ana i ka Poalima, Ak. 11/2, Kom. 56 Kh. e pili ana me ka Poalima
 Hem. 71 1/2, Kom. 49 Kh. e pili ana i ka pa & auwai, Ak. 82, Kom. 100 Kh. e pili ana i
 ka pa & ka auwai, Ak. 42 3/4, Kom. 157 e pili ana, i ka pa & auwai, a hiki
 ma Kahi i Chromaka'i = 31/100 Eka,

L. Bailey
Mea ana aina

Waikapu Maui Aug 27, 1852,

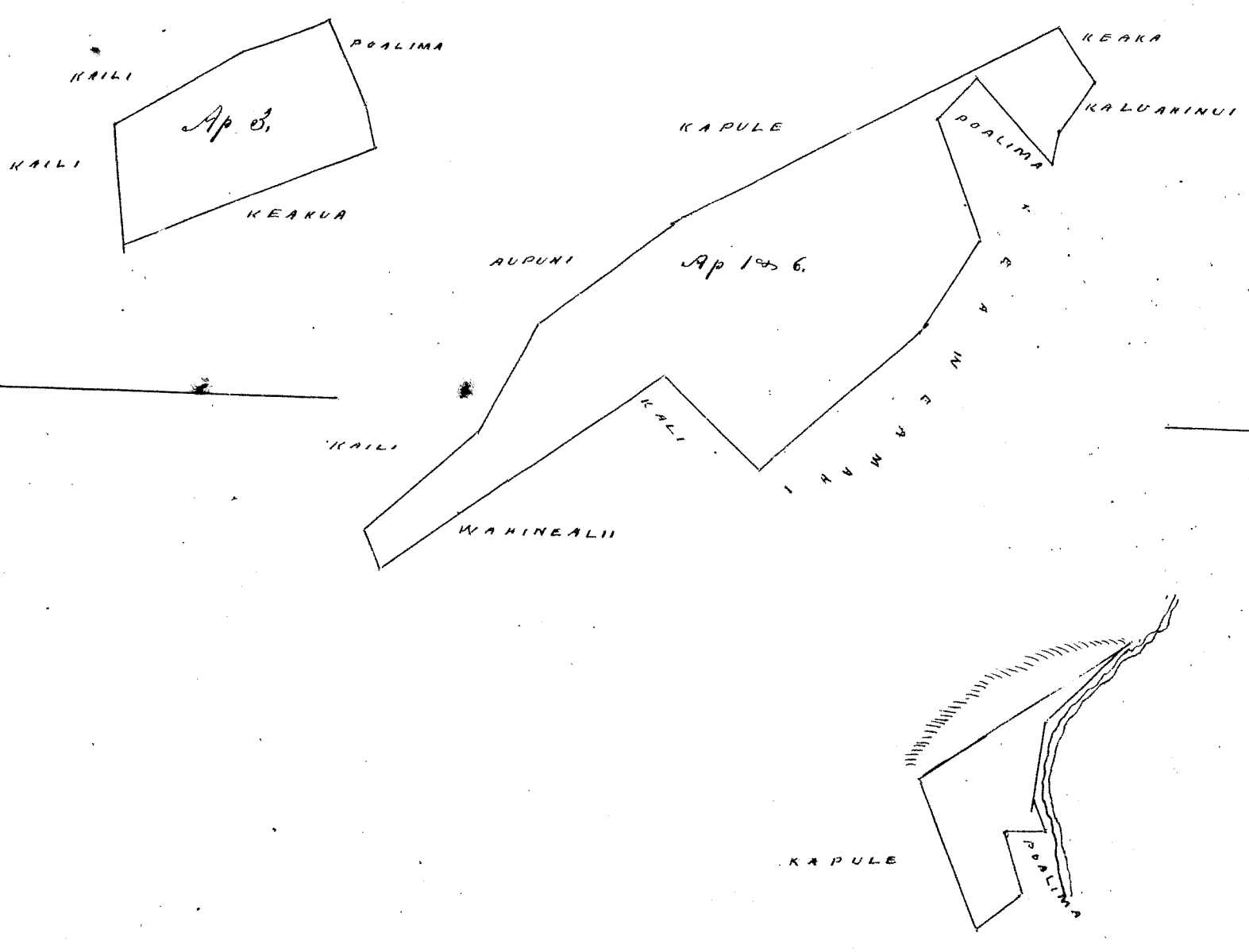

See Page 483, V3 Awards.
54 97 1.90

W. M. Robertson
J. H. Smith
J. Kekaulaha

Honolulu 27 Sep 1852.

Keleu 2203 Nahema

Kaikapuu Maui.

Apana 1. Kalo ma Palileiha, E hoomaka ana ke kahi, Nema; a e holo, Ak. 16° 37' N. 397. Kh ma ke Kula, Ak. 79 1/2°, No. 317 Kh. ma ke Kanaina, Hem. 9°, No. 282. Kh. ma ke J. Richardson, Hem. 55°, No. 294 Kh. ma ke D. Melo, a hiki ma ke kahi o mua, 97,000 Eka,

Apana 2, Aia i uka lilo loa,

Wailuku Aug 27. 1852,

C. Bailey,
Mea ana aino.

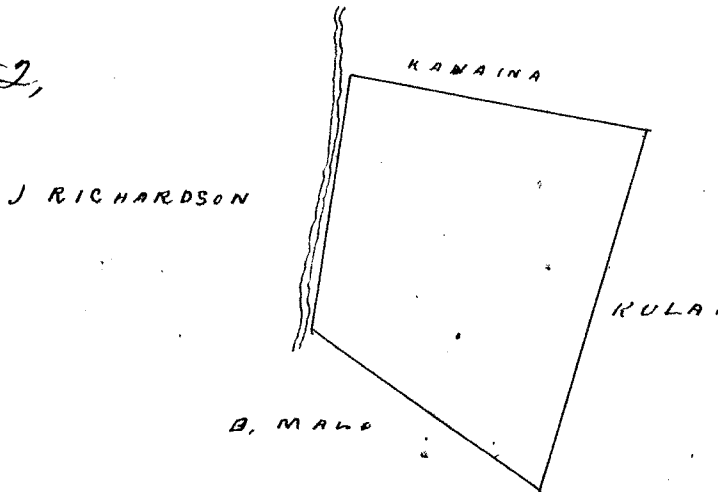

Wm Pau Loa # 4,

W. M. Robertson
J. H. Smith
J. Kekaulaha

Honolulu 27 Sep 1852.

Keleu 3390 Paale

Wailuku Maui

Palapala no ke ana ana i ke Kulanana, 3390, no Paale, Wailuku, Moku o Maui

Ap. 1.) Ili o Pohakua. E hoomaka ana ma ke kahi Nema, i Pili ana i ka Paahaa, a one Papohaku, e holo ana, Ak. 57° 45' Hem. 241 Kh. Papohaku, Ak. 45° 30' No. 2,00 Kh. Papohaku, Ak. 40° No. 0,70 Kh. Pohakuuli, Hem. 22° 30' Kh. Pohakuuli, No. 0,84 Kh. Pohakuuli, Ak. 29° 30' No. 0,98 Kh. Pohakuuli, Ak. 51° 30' No. 0,70 Kh. Pohakuuli, Ak. 21° No. 0,60 Kh. Pohakuuli, Hem. 78° No. 0,95 Kh. (Po-S) Hem. 19° 30' No. 0,68 Kh. Kalahaha, Hem. 78° No. 2,10 Kh. Kalahaha, Hem. 27° No. 3,54 Kh. Paahaa Loi, a hiki i ka hiki i hoomakaa, Malaka via Apana, 8 1/2 Kh.

8.50
1.50
7

Palima, i loko oia Apana, hoomaka ana ma ke kahi Kulanana, Hem. 75° 30' No. 1,53 Kh. Ak. 21° 15' No. 1,00 Kh. Ak. 76° 30' No. 1,51 Kh. Hem. 22° 45' No. 1,00 Kh. a puni, Malaka 1 1/2 Kh.

Ap. 2. Kalua, wa haalele oia

A. Kekaulaha,
Mea ana,

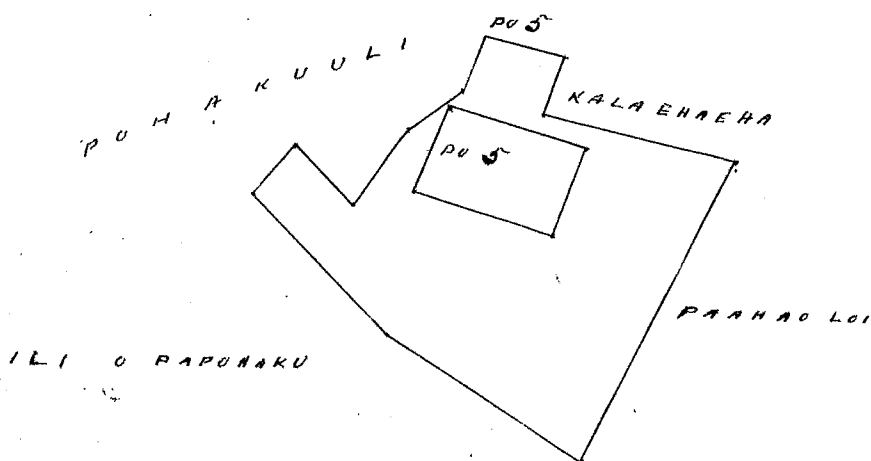

2 Kh. = 1. inika

Wku Pau Loa #4
W. H. P.
G. M. Robertson
J. H. Smith
J. Hekeaulahao

Honolulu 27 Sep 1852

Volu 2607 Pii

Waikapu Maui

Apana 1. Kalo ma Kapalaataca.
E hoomaka ma ke Pihia Ho. Ak. e pili ana i ka auwai, o Kapuhana, a e holo, Hem. 9 1/2°
Hi. 139 Kh. ma ka pa me auwai, Hem. 13 1/4° Hi. 213 Kh. ma ka pa o auwai, Hem. 84°
Hi. 308 Kh. ma ka Kapuhana, Ak. 3 3/4° Hi. 389 Kh. ma ke Kula, Hem. 86° Ho. 82 Kh.
ma ka Kapuhana, Hem. 5° Ho. 110 Kh. ma ka Ka Poalima, Hem. 86° Ho. 63 Kh. ma ka ka
Poalima. Ak. 5° Hi. 110 Kh. ma ka Ka poalima, Hem. 86° Ho. 218 Kh. ma ka Kapuhana,
a hiki ma ke Pihia mua, = 1 1/3 Eka.

Apana 2. Kalo ma Pihokou, Mahule 1.
E hoomaka ma ke Pihia Akau, a e holo, Hem. 7 1/4° Hi. 75 Kh. ma ka Koa, wale ma
Hem. 19° Ho. 46 Kh. ma ka Koa, Ak. 17° Hi. 33 Kh. ma ka Koa, Hem. 27° Ho. 65 Kh. ma
ka Koa. Ak. 13° Hi. 48 Kh. ma ka Koa, Hem. 15 1/2° Ho. 38 Kh. ma ka Koa, Ak. 19 1/2° Hi. 94
Kh. ma ka Koa, Hem. 69 1/2° Hi. 64 Kh. ma ka Koa, Hem. 65 1/2° Hi. 169 Kh. ma ka Koa,
Ak. 72 3/4° Ho. 87 Kh. ma ka Koa, Ak. 71° Ho. 59 Kh. ma ka Koa, Ak. 76 1/2° Ho. 144 Kh.
ma ka Koa, a puni = 2 1/2 Eka.

Mahule 2. E hoomaka ma ke Pihia Akau, a e holo ma ka Koa wale
ma, Hem. 7° Ho. 95 Kh. ma ka Koa, Ak. 6 3/4° Hi. 80 Kh. ma ka Koa, Hi. puni; 34 Kh.
ma ka Koa, Ak. 65 1/2° Ho. 34 Kh. ma ka Koa, a hiki ma ke Pihia mua, = 3/100 Eka.

Waikapu, Aug. 27, 1852.

E. Bailey
Ma ana.

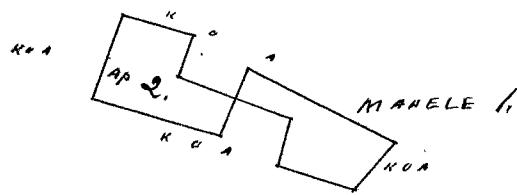
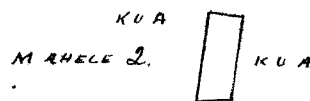
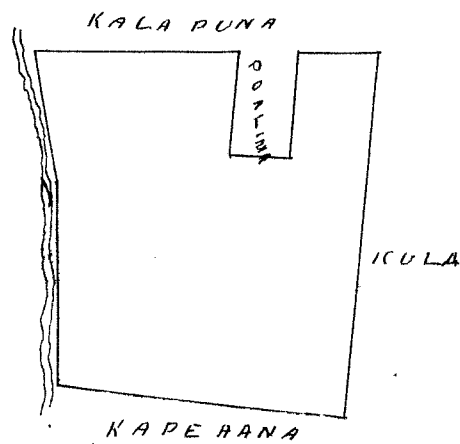

Olelohoakaka. Wa hoolia keia
ana ana a E. Bailey, a me keia la
i hoolia malala, a o ke ana ana
a John Richardson, a me keia la i
hoolia hoolia ma ka auo H. J. Butey,
ia ana a me ia la i hoolia
ka puni, he mea ole keia.

E. Kamais

(Maakakaulelo. L.H.K.)

Hale Kooia
Feb. 7, 1855

Wku Pau Loa #5

W. H. P.
G. M. Robertson
J. H. Smith
J. Hekeaulahao

Honolulu 27 Sep 1852

Apana 1, 2, 3 & 4. Kalo & Kula ma Kaalea, E hoomaka ma ke kahi hiki, a e holo,
 Ak. 23 1/2; Ho. 304 Kh. e pili ana me Opunui, Ak. 7 1/2; Ho. 300 Kh e pili ana me Naa
 maa, Nem. 4 3/4; Ho. 114 Kh. e pili ana me Ke Akua, Ak. 7 1/2; Ho. 218 Kh e pili ana,
 me Ke Akua, Nem. 15 1/4; Ho. 265 e pili ana me Ke Kula, Nem 76 1/2; Ho. 126 Kh. e
 pili ana i Ke Kula, Ak. 12 1/2; Ho. 193 Kh. e pili ana me Kula, Nem. 66; Ho. 387 Kh.
 a hiki ma ke Kahi mua, = 98/100 Eka,

Apana 5. Pahala ma Kamaalaea,
 E hoomaka ma ke kahi hiki Nema, a e holo, Ak. 9; Ho. 200 Kh. ma ke Alanui,
 Ak. 81; Ho. 125 Kh. ma ke Kula, Nem. 9; Ho. 200 Kh. ma Kula, Nem. 81; Ho. 125
 Kh. ma Kula, a hiki ma ke Kahi mua, 1/4 Eka,

Ua kuai ina apana e ae,
 Wailuku Aug 27, 1852,

C. Bailey
 Mea ana aina

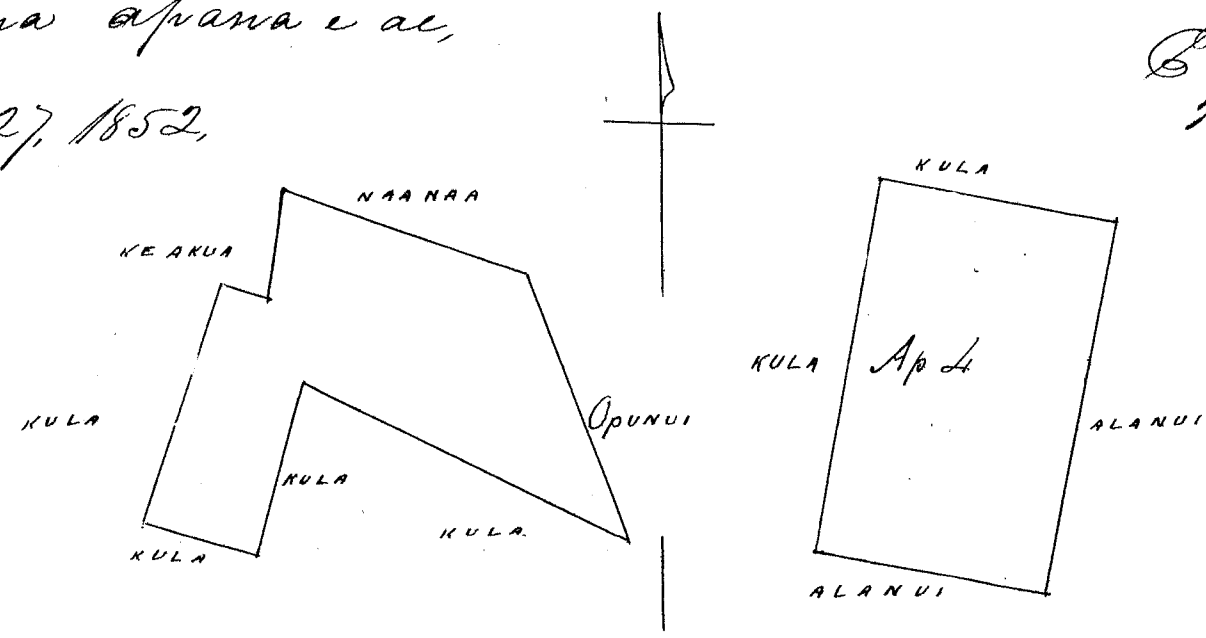

Uku Pau Loa / 5.
 W. H. H. H.
 G. M. Robertson
 J. H. Smith
 J. Kakaalaka

Honolulu 27 Sep. 1852

Apana 1, 2, 3 & 4. Kalo & Kula ma Pataleika,
 E hoomaka ma Ke auwai Kahi Ho. e pili ana me Kepaa, a e holo, Nem. 67; Ho. 636
 Kh. e pili ana i Ke Alanui, Ak. 19 1/2; Ho. 723 Kh. e pili ana i Ke Kula, Ak. 57; Ho. 140
 Kh. e pili ana me D. Malo, Ak. 58; Ho. 256 Kh. e pili ana me D. Malo, Ak. 87;
 Ho. 87 Kh. e pili ana me Ke auwai, Nem. 26 1/2; Ho. 124 Kh. e pili ana me J. Richa-
 rdson. & auwai, Nem. 28; Ho. 647 Kh. e pili ana me J. Richardson. & auwai, a hiki ma
 ke Kahi mua, = 3 3/100 Eka,

Wailuku Aug 27, 1852,

C. Bailey
 Mea ana aina,

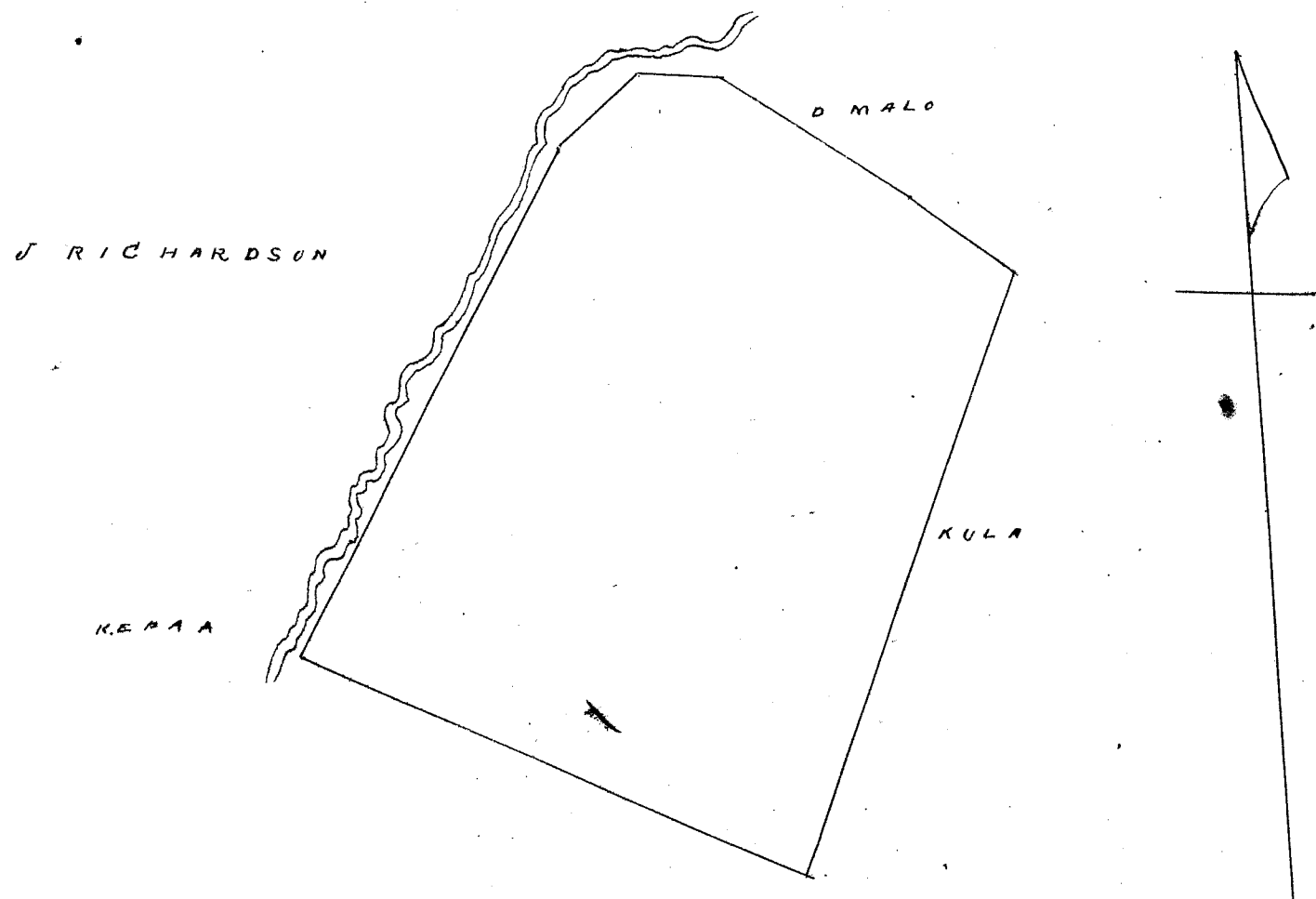

Uku Pau Loa # 7
W. H. H. W.
G. M. Robertson
J. Kekaulahas
J. H. Smith

Honolulu 27 Sep 1852

Uku 3524 Kahele

Waikapu Maui

Apana 1. Paakai ma ke alia E hoomaka ma ke Pihikiki, Hema, ma ke Alanui, a e holo, Ak. 4: Ho. 11.20 Kh. E pili ana me Mili, Ak. 79: Ho. 11.22 Kh. e pili ana me Aupuni, Hema. 1 1/2: Ho. 11.23 Kh. e pili ana me Kahiewalu, Hema. 1 7/8: Ho. 11.15 Kh. e pili ana me Alanui, a hiki ma ke Pihikiki mua 1 3/4 Eka.

Apana 2. Ua kono ma ke Pule ana o kekahi mea - me ka a e
Kahele, Waikapu, Aug. 18, 1852.
C. Bailey,
Ma ana ains

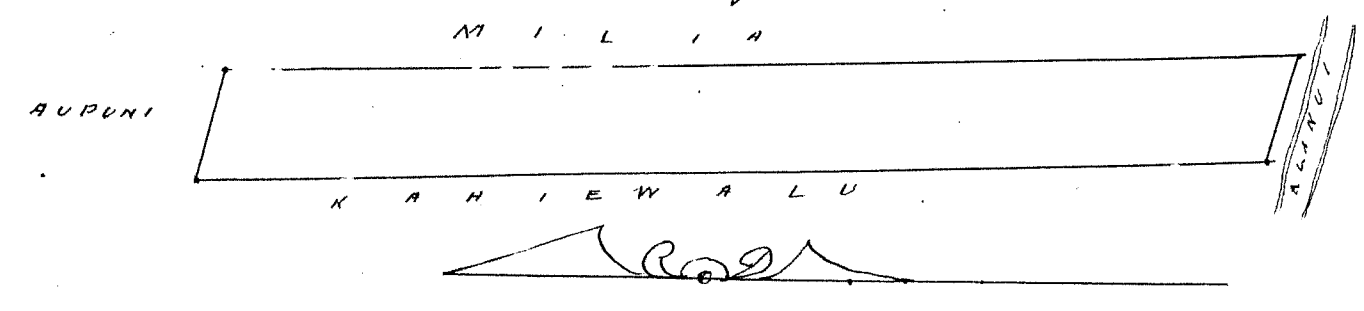

Uku Pau Loa # 5
W. H. H. W.
G. M. Robertson
J. Kekaulahas
J. H. Smith

Honolulu 27 Sep 1852

Uku 2959 Heika

Waikapu Maui

Apana 1 Ua huiia keia Apana me ke Ahaau, ka hooilina Hehu, 3340
Apana 2. Aole mahiai ma keia Apana,
Apana 3. Pahale ma Kanaaalaa,
E hoomaka ana, ma ke Pihikiki Hema, Hema, a e holo, Ak. 6: Ho. 2.50 Kh. ma ke Alanui, Hema. 8: Ho. 1.00 Kh. ma ke Kula, Hema. 6: Ho. 2.50 Kh. ma ke Kula, Ak. 8: Ho. 1.00 Kh. ma ke Kahakai, a hiki ma ke Pihikiki i hoomaka i 1/4 Eka

Apana 4. Oia ka Apana, Pahale i hoomoia ma ke Hehu, 3340 me Ahaau, ka hooilina, oia ke Keiki a Heika.
Waikapu, Aug. 18, 1852
C. Bailey,
Ma ana

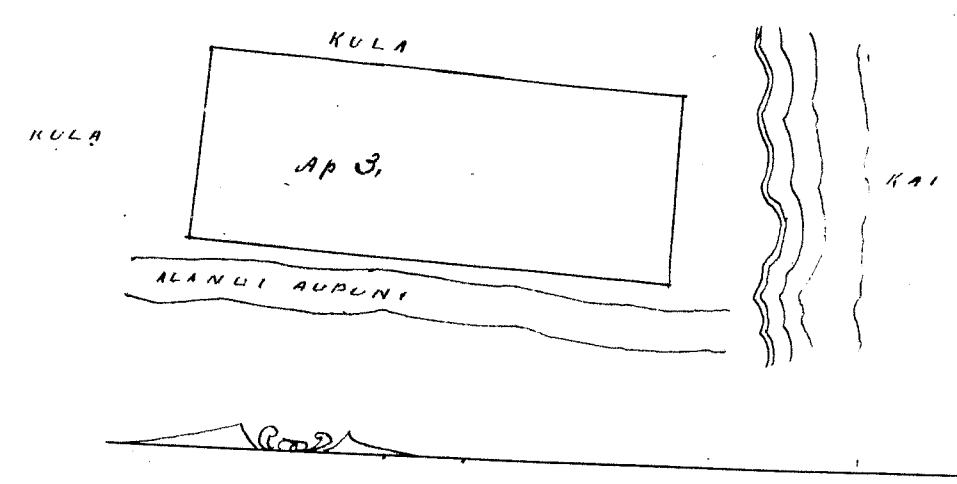

Wm Pau Loa # 3.

W. H. C. Bailey
G. M. Robertson
J. H. Smith
J. Kekaulahao

Honolulu 27 Sep 1852.

Kolu 3525. Kelelelele

Waikapu, Maui.

Apana 1. Ua haawi ia Kahau.
Apana 2. Aole i Mahiai
Apana 3. Pahale ma Kuaiwa, E hoomaka ma ke kahi hiki. Ak. e pili ana me Palakiko, a e holo, Nem. $87\frac{1}{2}$; Ho 80 Kh, e pili ana me Palakiko, Nem. $72\frac{3}{4}$; Ho 113 Kh, e pili ana me Palakiko, Nem. $53\frac{1}{2}$; Ho, 98. Kh, e pili ana me Akoni. C. Ak. 89° hiki. 205 Kh, e pili ana me Palakiko, Ak. 11. Ho, 129 Kh, e pili ana, me Palakiko, a hiki ma ke kahi mua, = $24\frac{1}{100}$ Eka,
Waikuku, Aug, 26, 1852

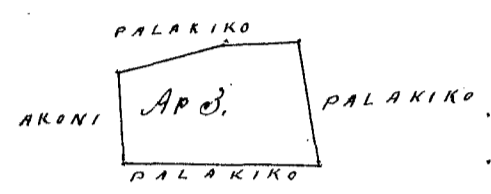

C. Bailey
Mea ana aina

Wm Pau Loa # 4

W. H. C. Bailey
G. M. Robertson
J. H. Smith
J. Kekaulahao

Honolulu 27 Sep 1852.

Kolu 5277 Hanakaloa

Waikapu Maui

Paakai ma Kealia, E hoomaka ma ke kahi Nema, ma ke alanui, e pili ana me Kahiewalu, a e holo, Ak. 6; Ho, 11,57 Kh, e pili me Kahiewalu, Ak. $88\frac{3}{4}$ Ho, 3,00 Kh, e pili ana me Aupuni, Nem. $11\frac{3}{4}$ Ho, 10,37 Kh, e pili me Kahiewalu, Nem. 76° Ho, 4,00 Kh, e pili ana me Alanui, a hiki ma ke kahi mua, = $4\frac{9}{100}$ Eka,
Waikuku, Aug, 26, 1852

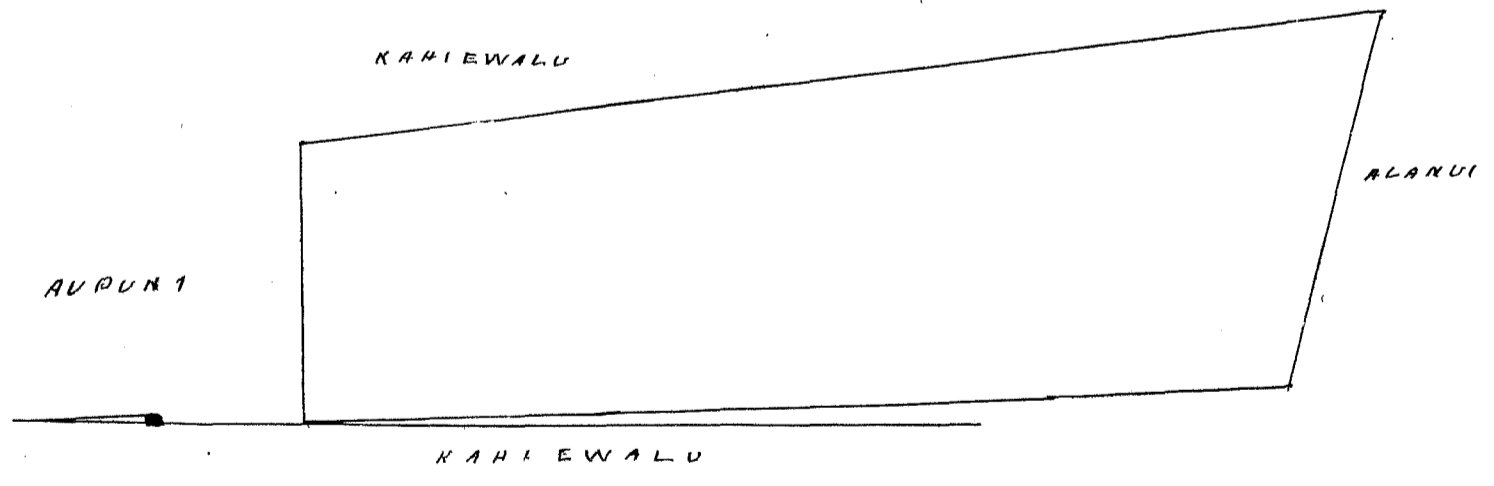

C. Bailey
Mea ana aina

Wm Pau Loa # 7

W. H. C. Bailey
G. M. Robertson
J. H. Smith
J. Kekaulahao

Honolulu 27 Sep 1852.

Keolu 3522 ^{ms} Kaula

Waikapu Maui

Apana 1. Aia la makea?

Apana 2, 3, 4 & 5. Kalo ma Punia

E hoomaka ma ke Pihahi Nema, e pili ana me ke Kaai & Keakua, a e holo, Ak. $43\frac{3}{4}$, Ki. 63 Akh, e pili ana i ka ai, Ak. 44 , Ki. 330 Kh e pili ana ia e kaanaa, Ak. $60\frac{3}{4}$, Ki. 94 Akh, e pili ana i ka lvi paahaa, Ak. $46\frac{1}{2}$, Ki. 91 Akh, e pili ana me ka pualima, Ak. 36, Ki. 61 Akh, e pili ana ia kaawahine, Ak. 36, Ki. 68 Akh, e pili ana me kamohai, Ak. $42\frac{3}{4}$, Ki. 191 Akh, e pili ana me Keawe, Ak. $23\frac{1}{2}$, Ki. 119 Akh, e pili ana me Kaili, Ak. $55\frac{3}{4}$, Ki. 99 Akh, e pili ana me Kaili, Ak. $29\frac{1}{2}$, Ki. 224 Akh, e pili ana me Keakua, a hiki ma ke Pihahi mua, = $89\frac{1}{100}$ Eka

Ua kuai via i ka Apana 6,

Waikapu, Aug. 26, 1852

C. Bailey

Mea ana aina,

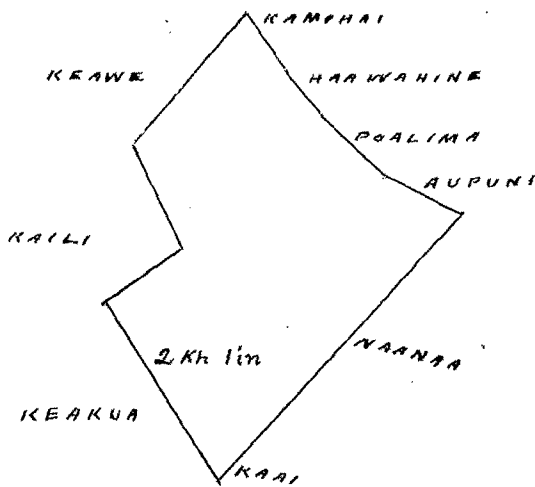

Uka Pau Loa / 4,

Uka

G. M. Robertson

J. H. Smith

J. Kaulahao

Honolulu 27. Sep. 1852

Keolu 8672 ^{ms} Kaula

Waikapu Maui

Apana 1. Kalo & Kula, ili - Kuaiwa,

E hoomaka ma ke Pihahi Nema, a e holo, Ak. 73, Ki. 153 Akh, e pili ana ia Akoni, Ak. $5\frac{1}{2}$, Ki. 623 Akh, e pili ana i ke Aupuni Kula, Ak. $83\frac{3}{4}$, Ki. 334 Akh, e pili ana i ke Aupuni Kula, Ak. 21, Ki. 673 Akh, e pili ana i ke ke Aupuni Kula, a hiki ma ke Pihahi mua, = $15\frac{1}{100}$ Eka,

Apana 2. Kalo ma Kuaiwa, E hoomaka ma ke Pihahi Akau, e pili ana me Palatikio, a e holo, Ak. $5\frac{1}{2}$, Ki. 128 Akh, e pili ana me Palatikio, Ak. 72, Ki. 192 Akh, e pili ana i ke Kahuwai, Ak. $4\frac{1}{2}$, Ki. 134 Akh, e pili ana me Akoni, Ak. $73\frac{3}{4}$, Ki. 195 Akh, e pili ana me Akoni, a hiki ma ke Pihahi mua, = $1\frac{1}{4}$ Eka,

Apana 3. I. lvi ma Kaulipalata, e hoomaka ma ke Pihahi Kibina, a e holo ma ke Akoni aina a puni penei, Ak. $75\frac{1}{2}$, Ki. 54 Akh, Ak. 86, Ki. 52 Akh, Ak. $18\frac{1}{2}$, Ki. 124 Akh, Ak. 20, Ki. 119 Akh, a hiki i ke Pihahi mua, = $6\frac{1}{100}$ Eka,

Waikapu Aug 20, 1852,

C. Bailey

Mea ana aina

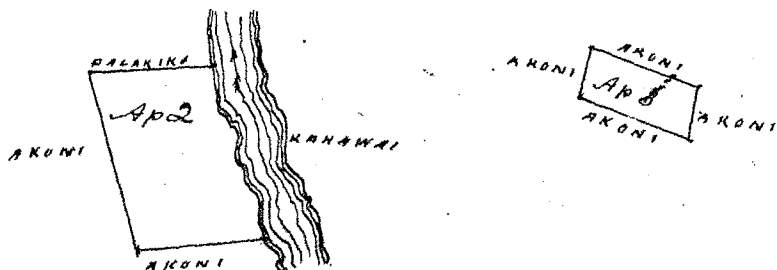
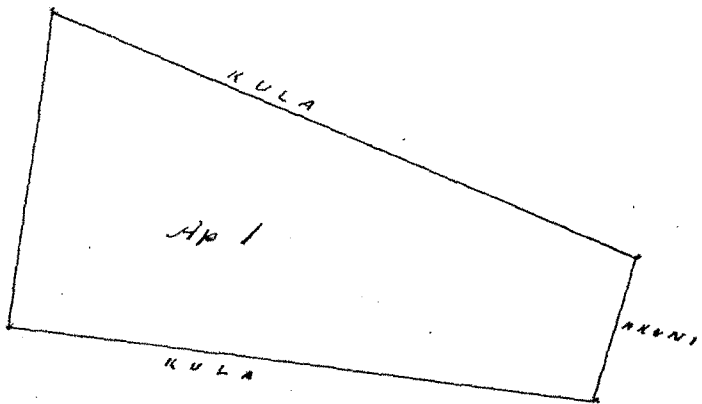

Uku Pau Loa # 5.

W. H. H. H.
G. M. Robertson
J. H. Smith
J. Kaulahas

Honolulu 27 Sep 1852.

Hulu # 280 Keakahu

Waikapu Maui

Apana 1, 2 & 3, Ili o Kaopala. E hoomaka ma ke kiki Kema, e pili ana me Ma-kiki & Waiko, a e holo, Ak. $12\frac{3}{2}$, Ko. 360 Kh, e pili ana me Hakiki, Ak. 17, Ko. 68 Kh, e pili ana me Makuakane, Ak. $59\frac{1}{2}$, Ni. 315, Kh, e pili ana me ke Kahuwai, Ak. 23, Ko. 221 Kh, e pili ana me Kapailoi, Ak. $56\frac{3}{4}$, Ni. 88, Kh, e pili ana me ke Kapailoi, Ak. 35, Ko 73, Kh, e pili ana me Waiko, a hiki ma ke kiki mua, = $12\frac{3}{2}$ Eka,

Apana 4, Paakai ma Kealia, E hoomaka ma ke kiki Kite, Kema, e pili ana i ke Kehoahewale, a e holo, Ak. $8\frac{1}{2}$, Ko. 263 Kh, e pili ana me ke Kehoahewale, Ak. $5\frac{1}{2}$, Ko. 411 Kh, e pili ana me ke Paalima, Ak. 85, Ko. 205 Kh, e pili ana me ke Aupuni, Ak. $17\frac{1}{2}$, Ni. 682 Kh, e pili ana me Kanaupio, Ak. $88\frac{1}{2}$, Ni. 792 Kh, e pili ana me ke alama a hiki ma ke kiki mua, = $92\frac{1}{100}$ Eka,

Apana 5, Paakai ma Kealia, E hoomaka ma ke kiki Kite, Kema, e pili ana me Pahi, a e holo, Ak. 5, Ni. 730 Kh, e pili ana me Pahi, Ak. $77\frac{1}{4}$, Ko. 95 Kh, e pili ana me ke Aupuni, Ak. 8, Ko. 683 Kh, e pili ana me ke Aupuni, Ak. 77, Ni. 127 Kh, e pili ana i ke alama, a hiki ma ke kiki mua, = $67\frac{1}{100}$ Eka,

Paalima ma ke Apana 1, 2, 3 E ana ma ke kiki Kema. Kapailoi, Ak. $50\frac{1}{2}$, Ko. 43 Kh, a i ke kiki mua, alaila holo, Ak. 24, Ni. 68 Kh, e pili ana me Kahuwai, Ak. 63, Ko. 57 Kh, e pili ana me Kahuwai, Ak. $39\frac{3}{4}$, Ko. 52 Kh, e pili ana me Kahuwai, Ak. $50\frac{1}{4}$, Ni. 73, Kh, e pili ana me Kahuwai, a puni, = $4\frac{1}{100}$ Eka,

Waikapu, Aug. 20, 1852

C. Bailey
Mea ana aina

92
67
1.59

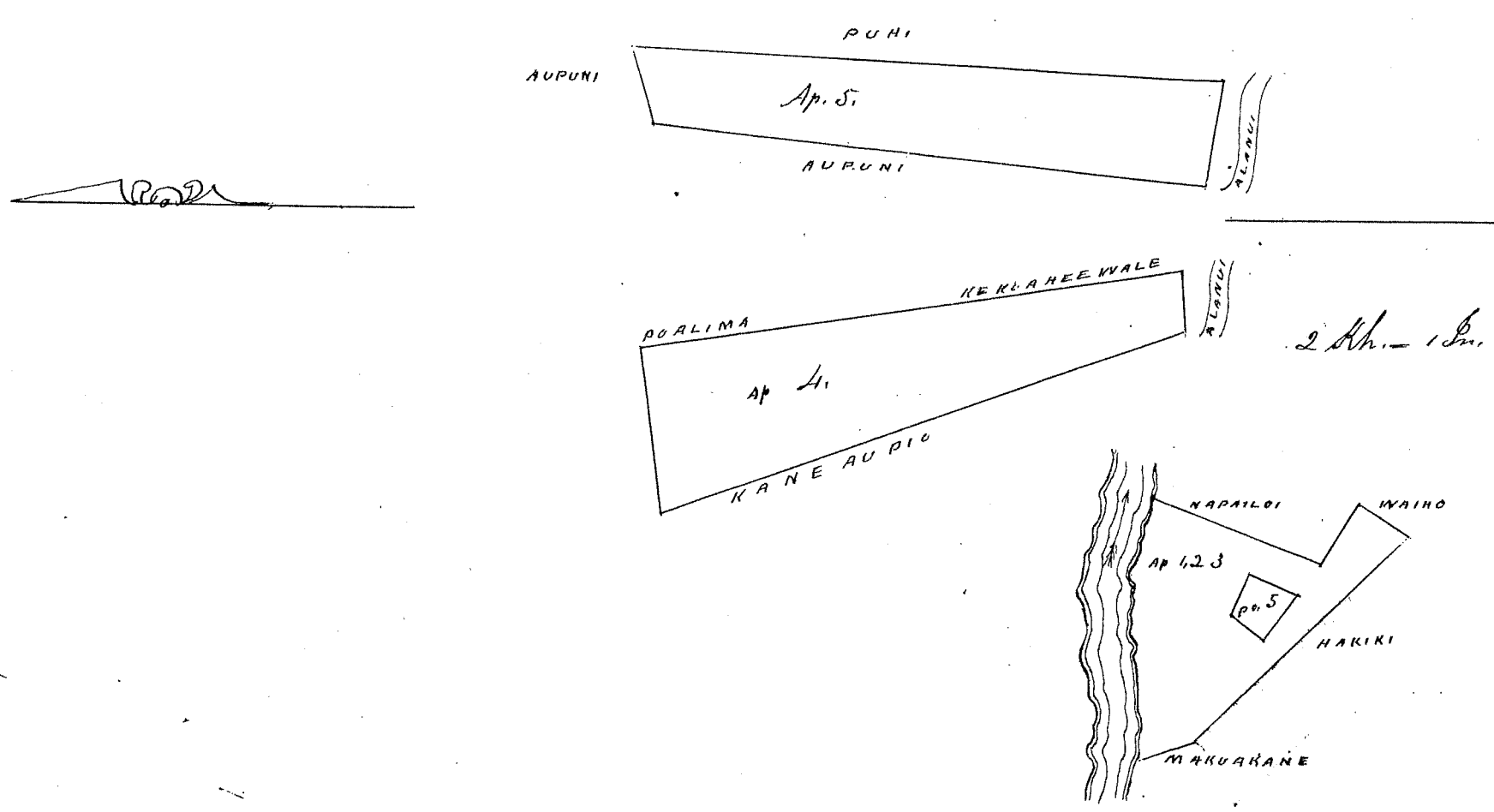

Uku Pau Loa # 5.

W. H. H. H.
G. M. Robertson
J. H. Smith
J. Kaulahas

Honolulu 27 Sep 1852

Apana 1. Ili o Kaikapu, E hoomaka ma ke kahi Aka, oia ke kahi Hikina Aema o Mahuka, a e holo, Hem. 30° Ni, 58 Kh, e pili me ka ili o Luapuaa, Hem. 59° Ni, 65 Kh e pili me ka ili o Kaneae, Ak. 33° Ni, 66 Kh, e pili me ka ili o Kaneae, Ak. 65 1/2° Ni, 67 Kh, e pili me Mahuka, a hiki i ke kahi mua. — 1/2o Eka.
 Ua kuai ia kekahi mau loi a lilo ia Keakini.

Apana 2. Ili o Kaikapu, E hoomaka ma ke kahi Aema, oia ke kahi Aema Aema o Kaneae, a e holo, Ak. 62° Ni, 54 Kh, e pili ana me ke Kula maloo, Ak. 26 3/4° Ni, 98 Kh, e pili ana me ke Kula maloo, Hem. 62 1/2° Ni, 48 Kh, e pili ana me Kaneae, Hem. 25° Ni, 99 Kh, e pili me Kaneae, a hiki i ke kahi mua. 1/2o Eka.

Apana 3 Ili o Kaikapu, E hoomaka ma ke kahi Ni, oia ke kahi Aka o Kamohai, e holo, Hem. 41° Ni, 120 Kh, e pili me Kamohai, Ak. 65° Ni, 109 Kh, e pili ana i ke Kula maloo, Ak. 36 1/4° Ni, 78 Kh, e pili me Kaneae, Ak. 82 1/2° Ni, 91 Kh, e pili ana me Kaai, Hem. 52° Ni, 57 Kh, e pili ana me ka ili o Luapuaa, a hiki i ke Kahi mua, 1 3/4o Eka.

Apana 4. Ili o Kaopala, E hoomaka ma ke kahi Hikina, oia ke kahi Kahi Aka, o Kamohai, e holo, Hem. 40 1/2° Ni, 186 Kh, e pili me Po 5, o Kamohai, Ak. 36° Ni, 61 Kh, e pili ana me Kawana, Ak. 39° Ni, 169 Kh, e pili me Kula, Hem. 49 3/4° Ni, 62 Kh, e pili ana me Haikiki, a hiki ma ke Kahi mua. — 1/1o Eka.

Apana 5. Aia i uka lilo loa — ke pahi loa.

Waikuku, Aug. 14, 1852

C. Bailey
 Mea ana aina

1.20 =
 1.20 =
 13
 0.53 = E

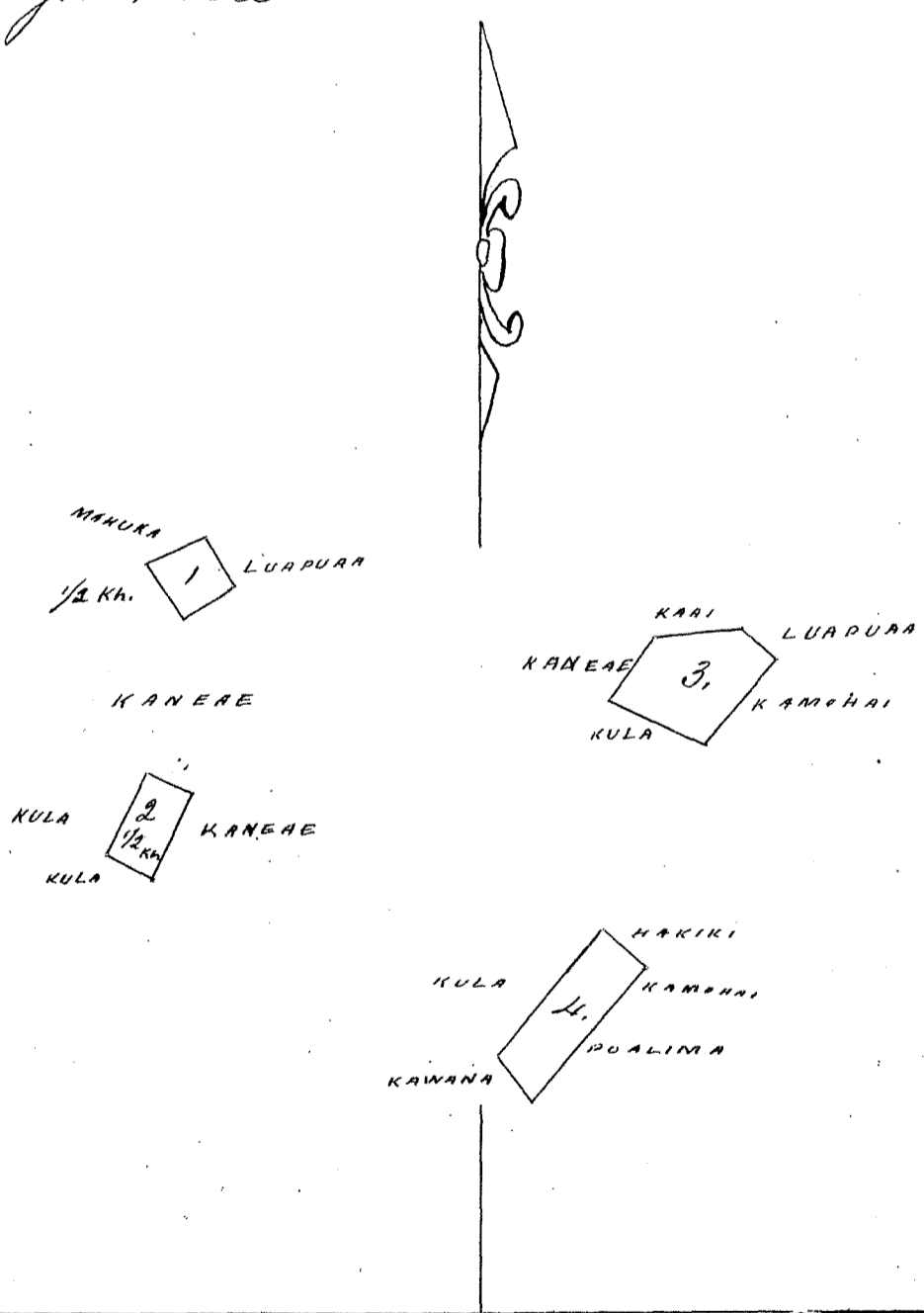

Uka Pau Loa

W. H. Bee
 G. M. Robertson
 J. H. Smith
 J. Kekaulahao

Honolulu, 27 Sep. 1852

Apana 1 Kalo & Kula ma Loaloa.

E hoomaka ma ke kiki kuma, a e holo, Ak. 32 1/2; Ni 2,31 Kh. ma ka auwai, Ak. 8 1/2; Ni 4,00 Kh. ma ka auwai, Ak. 27 3/4; Ni 4,00 Kh. ma ka auwai, Ak. 27 3/4; Ni 1,170 Kh. ma ka auwai, Ak. 77; Ko. 8,00 Kh. ma ko J. Richardson, Ak. 15; Ko 187 Kh. ma ko J. Richardson, Ak. 76 1/4; Ko. 1,31 Kh. ma ko, J. Richardson, Nem. 23 1/2; Ko. 2,40 Kh. ma ko Kuikono, Nem. 73 3/4; Ko. 91 Kh. ma ko Kuikono, Nem. 2 3/4 Ni 1,57 Kh. ma ko Wm. Mc Lane, Nem. 21 3/4; Ko. 3,66 Kh. ma ko Wm. Mc. Lane, Nem. 76 1/4; Ni 87 Kh. ma ko Keakua, Nem. 15 1/4; Ko. 1,84 Kh. ma ko Keakua, Nem. 54 1/4; Ni 9,60 Kh. ma ko Kai ma, a hiki ma ke kiki mua, = 10 26/100 Eka,

Kaina, E hoomaka ma ke kiki kiki, kuma, holo, Ak. 13 1/2; Ni 47 Kh. ma ko Kepaa, Ak. 71 1/4; Ko 2,00 Kh. ma ko Kepaa, Nem. 20 1/4; Ko. 54 Kh. ma ko Kepaa, Nem. 74 1/4; Ni 2,05 Kh. ma ko Kepaa, a hiki ma ke kiki mua, 1/10 Eka,

10. 26
9
36

Poalima, Mai ke kiki Ak. o Apana 1. e ana, Nem. 51; Ni 30, i ke kiki mua, holo, Nem. 70 1/2; Ni 5,1 Kh. ma ko Kepaa, Nem. 16 1/2; Ko 150 Kh. ma ko Kepaa Ak. 65 1/4; Ko 47 Kh. ma ko Kepaa, Ak. 15 1/4; Ni 149 Kh. ma ko Kepaa, a hiki ma ke kiki mua, = 8/100 Eka,

Apana 2. Wa kuai ia aku oia ia Keakua.

Apana 3. 1. Loi ma Punia E hoomaka ma ke kiki Ni. e pili me Opunui, a e holo, Nem. 53 1/2; Ko. 1,50 Kh. e pili me Opunui, Ak. 80 3/4; Ko. 33 Kh. e pili me Poalima, Ak. 25 3/4; Ni 115 Kh. e pili me Naanaa, Ak. 80; Ni 105 Kh. e pili me Naanaa, a hiki ma ke kiki mua, = 8/100 Eka,

Apana 4. Pahale ma Kamaalala, E hoomaka ma ke kiki Ko, a e holo, Ak. 65; Ni 158 Kh. ma ke Kula, Nem. 25; Ni 158 Kh. ma ke Kula, Nem. 65; Ko. 158 Kh. ma ke Kula, Ak. 25; Ko. 158 Kh. ma ke Kula, a hiki ma ke kiki mua, = 1/4 Eka,

Waikapu, Aug. 26, 1852.

E. Bailey
Mea ana aina

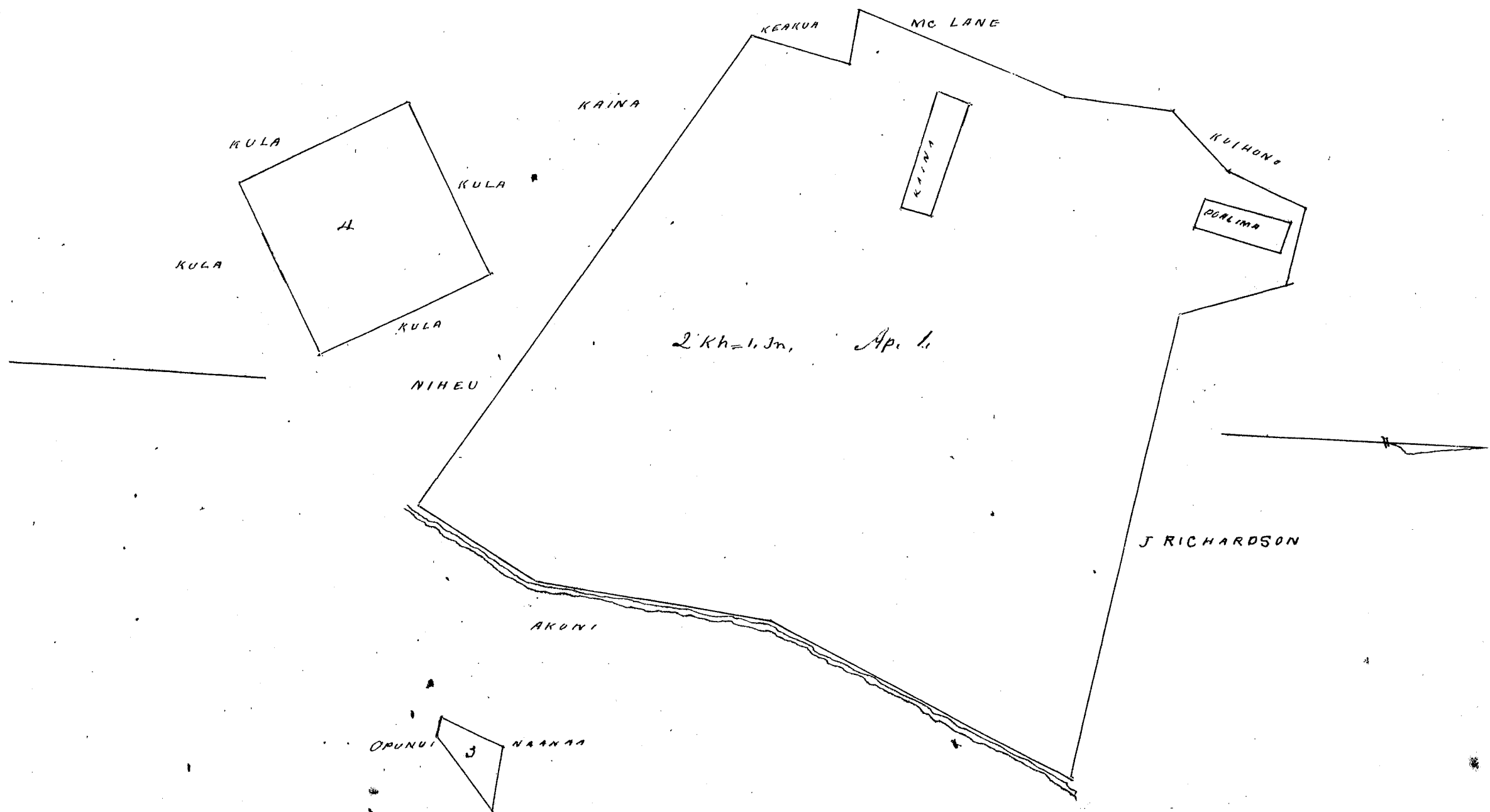

G. M. Robertson
J. Kekaulahas
D. H. Smith

Honolulu 27 Sept 1852.

Heleu 5286 Kameaupio

Waikapu Maui

Apana 1. Pahale ma Kealia. Chromaka ma ke kahi Kikina Nema, a e holo. Apana ponoi, 158 Kh. e pili ana me Aupuni, Nem. ponoi, 158 Kh. e pili ana me Aupuni, Nema ponoi 158 Kh. e pili ana me Aupuni, Kikina ponoi 158 Kh. e pili ana me Aupuni a hiki ma ke kahi mua $\frac{1}{4}$ Eka.

Apana 2, Paakai ma Kealia. Chromaka ma ke alanui, Kahi Kikina Nema, a e holo, Ak. Li. Ki. 906 Kh. e pili ana me Aupuni, Nem. $8\frac{1}{2}$ No. 196 Kh. e pili ana me Aupuni, Nem. $4\frac{1}{2}$ No. 850 Kh. e pili ana me Aupuni, Nem. 76° Ki. 208 Kh. e pili ana me Alanui, a hiki ma ke kahi mua, $1\frac{1}{4}$ Eka.

Apana 3, Paakai ma Kealia. Chromaka ma ke alanui, Kahi Kikina Nema, a e holo, Ak. $17\frac{1}{2}$ No. 682 Kh. e pili ana me Kahuhi, Nem. $78\frac{3}{4}$ No. 130 Kh. e pili ana me Aupuni, Nem. $2\frac{1}{2}$ Ki. 607 Kh. e pili ana me Aupuni, Nem. 87° Ki. 306 Kh. e pili ana me Alanui, a hiki ma ke kahi mua, $1\frac{3}{100}$ Eka.

Waikutu Aug 26. 1852

C. Bailey
Ma ana ana

.25
1.74
1.37
3.36

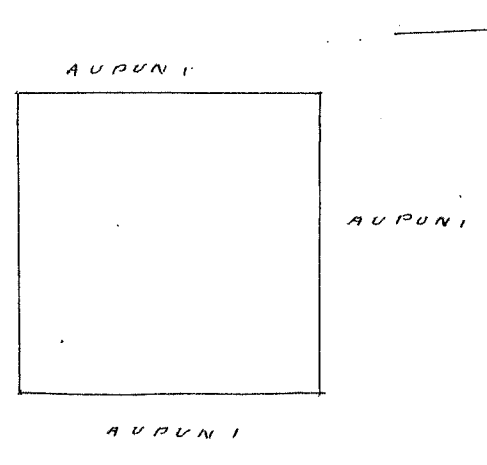
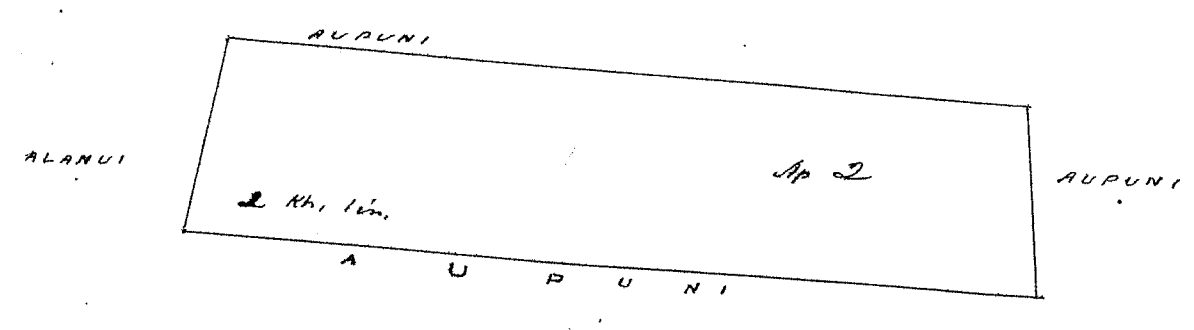
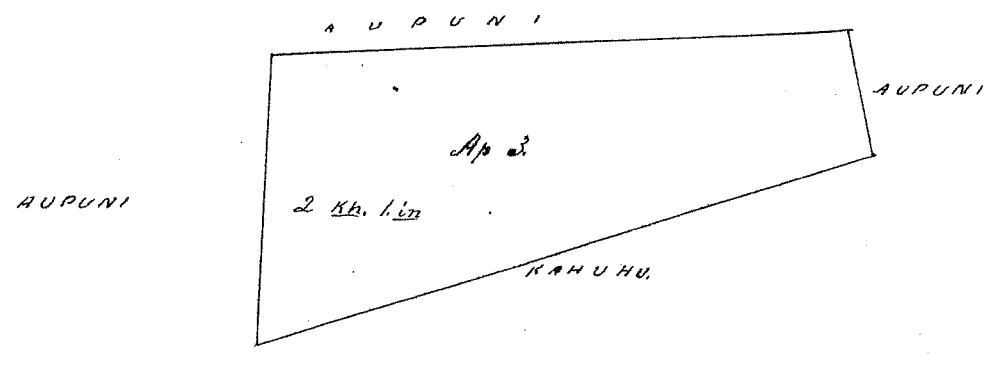

W. H. Keen
G. M. Robertson
D. H. Smith
J. Kekaulahas

Honolulu, 27 Sep. 1852.

Aprana 1. Kalo ma Kalapulu, Choomaka ma ke Pihiki Hikiina, e pili ana ma Kaai, a e holo, Ak. 64 1/2; Ko. 135 Kh. e pili ana ma Kaai, Ak. 68; Ko. 72 Kh. e pili ana ma Keakini, Ak. 76 1/2; Ko. 112 Kh. e pili ana ma Kaai, Sem. 16 3/4; Ko. 94 Kh. e pili ana ma Poalima, Sem. 73; Hi. 291 Kh. e pili ana ma ke Kula, Ak. 36 1/4; Hi. 78, Kh. e pili ana ma Haawahine, a hiki ma ke Pihiki mua, = 29/100 Eka,

Aprana 2. Kalo ma Kalapulu, Choomaka ma ke Pihiki Hi. e pili ana ma Keakini a e holo, Ak. 70, Ko. 208 Kh. e pili ana ma ke Kula, Ak. 30; Ko. 232 Kh. e pili ana ma ke Kula, Sem. 59; Ko. 65, Kh. e pili ana ma Haawahine, Ak. 33; Ko. 66 Kh. e pili ana ma Haawahine, Ak. 74 1/2; Ko. 69, Kh. e pili ana ma ke Kula, Sem. 13; Ko. 191 Kh. e pili ana ma ke Kula, Sem. 62 1/2; Hi. 168 Kh. e pili ana ma ke Kula, Sem. 25; Ko. 99, Kh. e pili ana ma ke Haawahine, Sem. 64; Hi. 99, Kh. e pili ana i ke Kula, Ak. 20, Hi. 72 Kh. e pili ana ma ke Kula, Sem. 78; Hi. 284 Kh. e pili ana i ke Kula, Ak. 7 1/2; Hi. 76 Kh. e pili ana ma Keakini, a hiki ma ke Pihiki mua = 87/100 Eka

Aprana 3. Kalo ma Kalapulu, Choomaka ma ke Pihiki Hikiina, e pili ana ma Kaai, a e holo, Sem. 5 3/4; Ko. 359 Kh. e pili ana ma Kaai, Ak. 84; Ko. 204, Kh. e pili ana i ke Kula, Ak. 2; Ko. 214 Kh. e pili ana ma Keakini, Sem. 79 3/4; Hi. 150 Kh. e pili ana ma Mahuka, Akau pono, 73 Kh. e pili ana ma Mahuka, Ak. 82 1/2; Ko. 124, Kh. e pili ana ma Mahuka, Sem. 13; Ko. 64, Kh. e pili ana ma Mahuka, Ak. 75 1/2; Ko. 64, Kh. e pili ana ma Keakini, Ak. 4 1/2; Hi. 98 Kh. e pili ana ma Keakini, Sem. 89 1/2; Hi. 338 Kh. e pili ana i ke Kula, a hiki ma ke Pihiki mua, = 8/10 Eka,

Aia i nka lilo loa ka Aprana 4.

Waikapu, Aug 26, 1852.

C. Bailey
Ma ana aina

.29
87
82
196

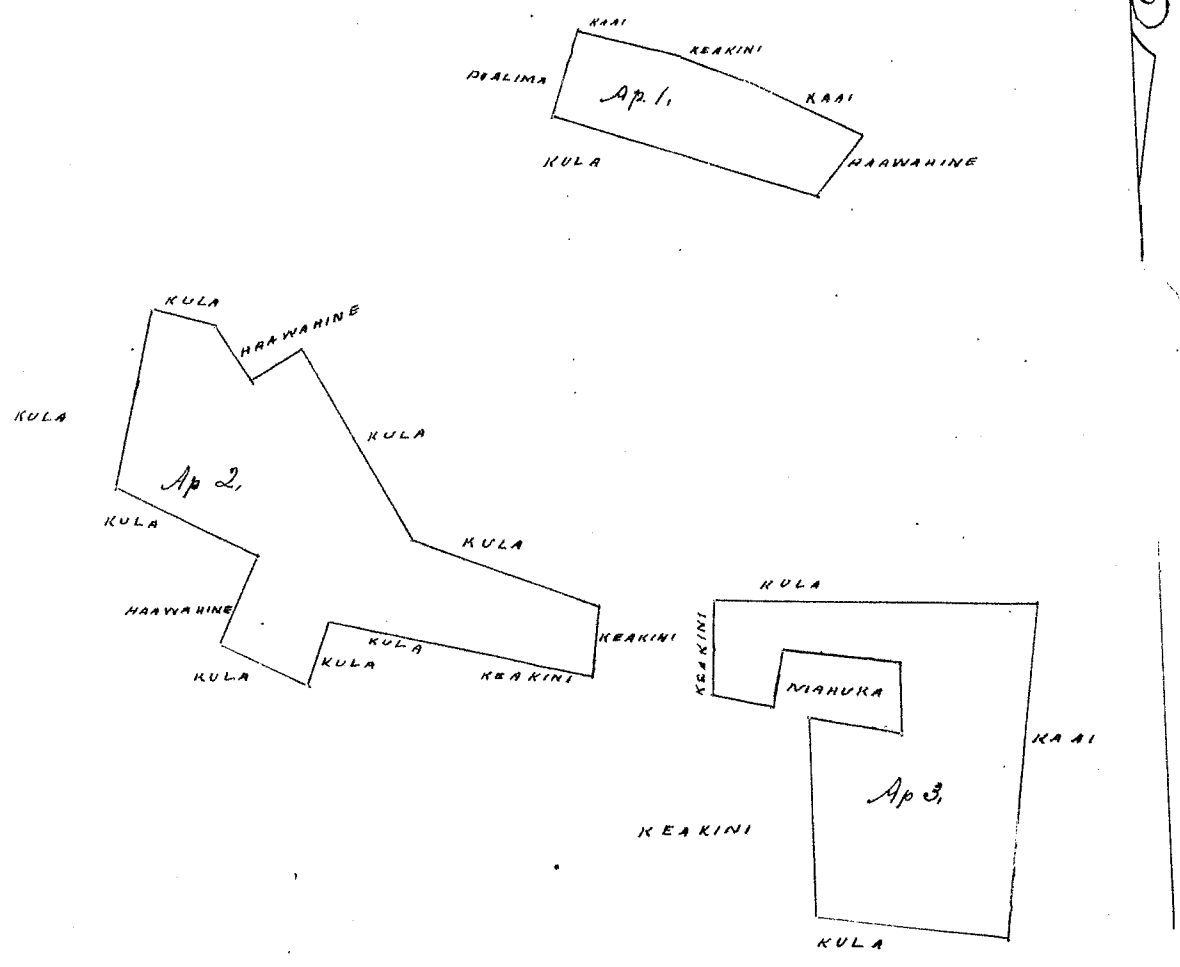

Uku Pau Loa \$ 5.
W. H. Keew
G. M. Robertson
O. H. Smith
J. Kekaulaha

Honolulu, 27, Sep. 1852

Apana 1. Paakai ma Kealia, Choomaka ma ke alanui, Kihikihi, Homa o Keia a e holo, Ak. 69 1/2, Ko. 1.90 Kh, e pili ana me Alanui, Ak. 6, Ko 11.51 Kh, e pili ana me Kanakaloa, Hem. 71, Ki. 2.35 Kh, e pili ana me Aupuni, Hem. 4 1/2, Ki. 11.23 Kh, e pili ana me Kahale, a hiki ma ke Kihikihi mua, L. 23/100 Eka.

Apana 2. Paakai ma Kealia, Choomaka ma ke Kihikihi, Homa, e pili ana me ke alanui, Kanakaloa, a e holo, Ak. 71, Ko. 6.00 Kh, e pili ana me ke alanui, Ak. 5, Ki. 8.64 Kh, e pili ana ma ke Puhii, Hem. 88, Ki. 4.53 Kh, e pili ana me ke Aupuni, Hem. 13 1/4, Ki. 10.37 Kh, e pili ana ma ke Kanakaloa, a hiki ma ke Kihikihi mua, L. 85/100 Eka.

Apana 3. Kikahi aao ia o ka Apana 1. Choomaka ma ke Kihikihi, a e holo, Ak. 73 Ko. 2.00 Kh, ma kapa alanui, Hem. 17, Ko. 1.25 Kh, ma ke Kula, Hem. 73, Ki. 2.00 Kh, ma ke Kula, Ak. 17, Ki. 1.25 Kh, ma ke Kula, a hiki i ke Kihikihi mua - 1/4 Eka.

Waikapeu Aug. 18. 1852

E. Bailey,
Mea ana,

2.23
4.85
25
7.33

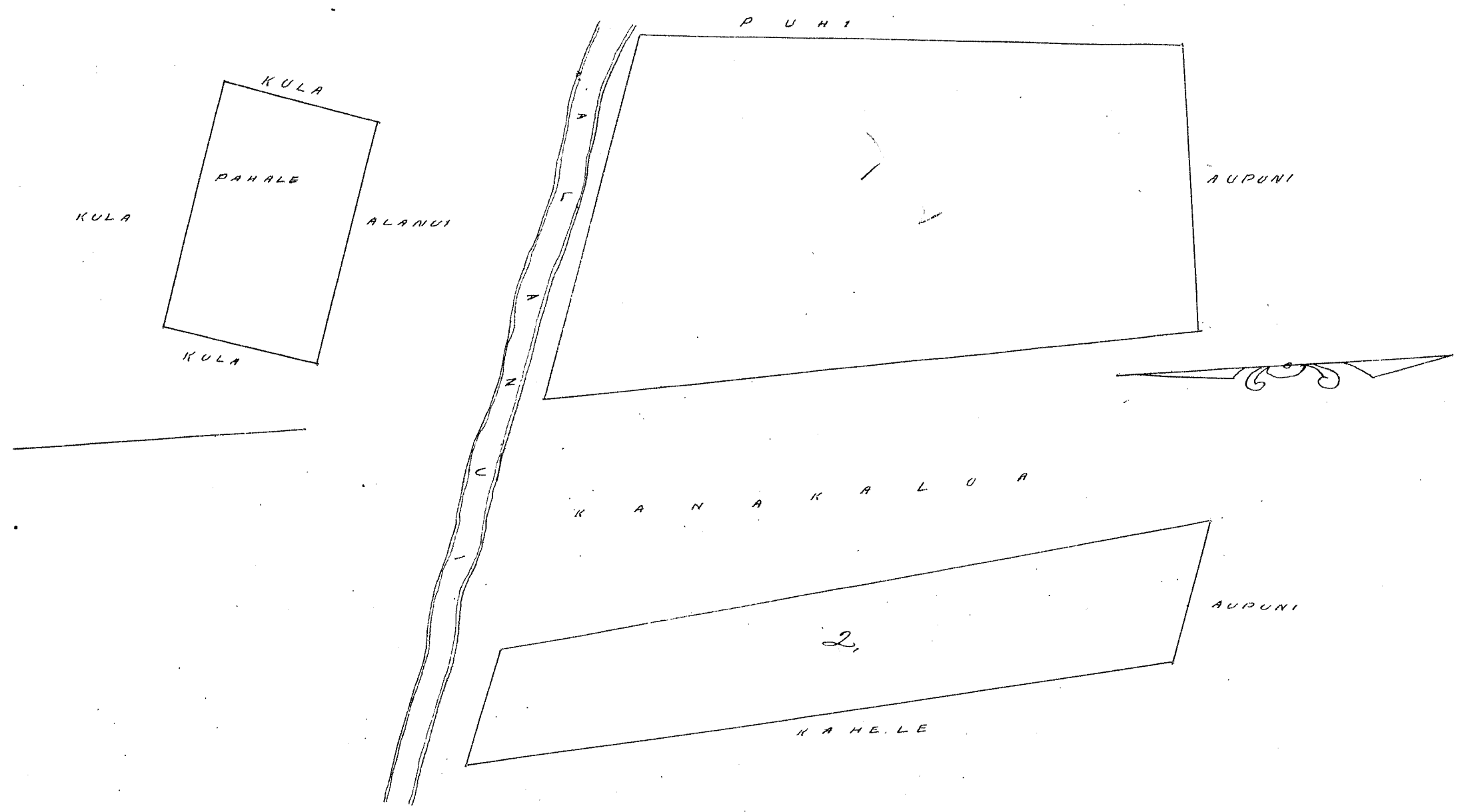

Wm Pau Loa 8

W. L. Lee
G. M. Robertson
J. Kekaulahas
J. H. Smith

Honolulu 27 Sept. 1852

Hulu 3546. Kaula

Waikapu Maui.

Apana 1. Aia ma uka loa, ma ke kahawai ma ka ili. Mokaulelu, Chomaka ma ke kahi ma uka loa via ke Pumu pali ma ka arao Akau, ke Kahawai a e holo ma ke Pumu, a ka pali a loa ke Pahi ma ka loa, ma ia arao, alaila holo. Nem. 45 Sti. 140 Kh. a loa ke Pumu pali; ma ka arao Aua. ke Kahawai a e holo ma uka, ma ke Pumu. ka pali; a loa ke Pahi ma uka loa ma ia arao. 2.30 o. alaila holo. Ak. 65, No 170 Kh. a hiki i ke Pahi mua, 2 3/10 Eka. N. B. O ka hiki via Apana ke ana maloko. ke Kahawai; = 25,00 Kh.

Apana 2. Ili. Maana. Chomaka ma ke kumu kuku, kahi ma uka o kua ma ke Kahawai; a e holo ma ke Kahawai i ke Pumu wiliwili ma ke Pahi ma uka loa, alaila holo i ka pali; 30 piau, alaila holo ma ke Pumu o ka pali; a hiki i ke Pahi mua, 1 2/10 Eka.

Apana 3. Ili. Mokaulelu. Chomaka ma ke Pahi Komohana. Akau, a e holo, hikiina pona; 318 Kh. ma ke Pua maloo, Aua pona; 317 Kh. ma ke Pua Maloo. Komohana pona; 318 Kh. ma ke Pua Maloo. Akau pona; 317 Kh. a hiki i ke Pahi mua, - 1 Eka.

Maui, 5, 1852

C. Bailey
Luna ana aina

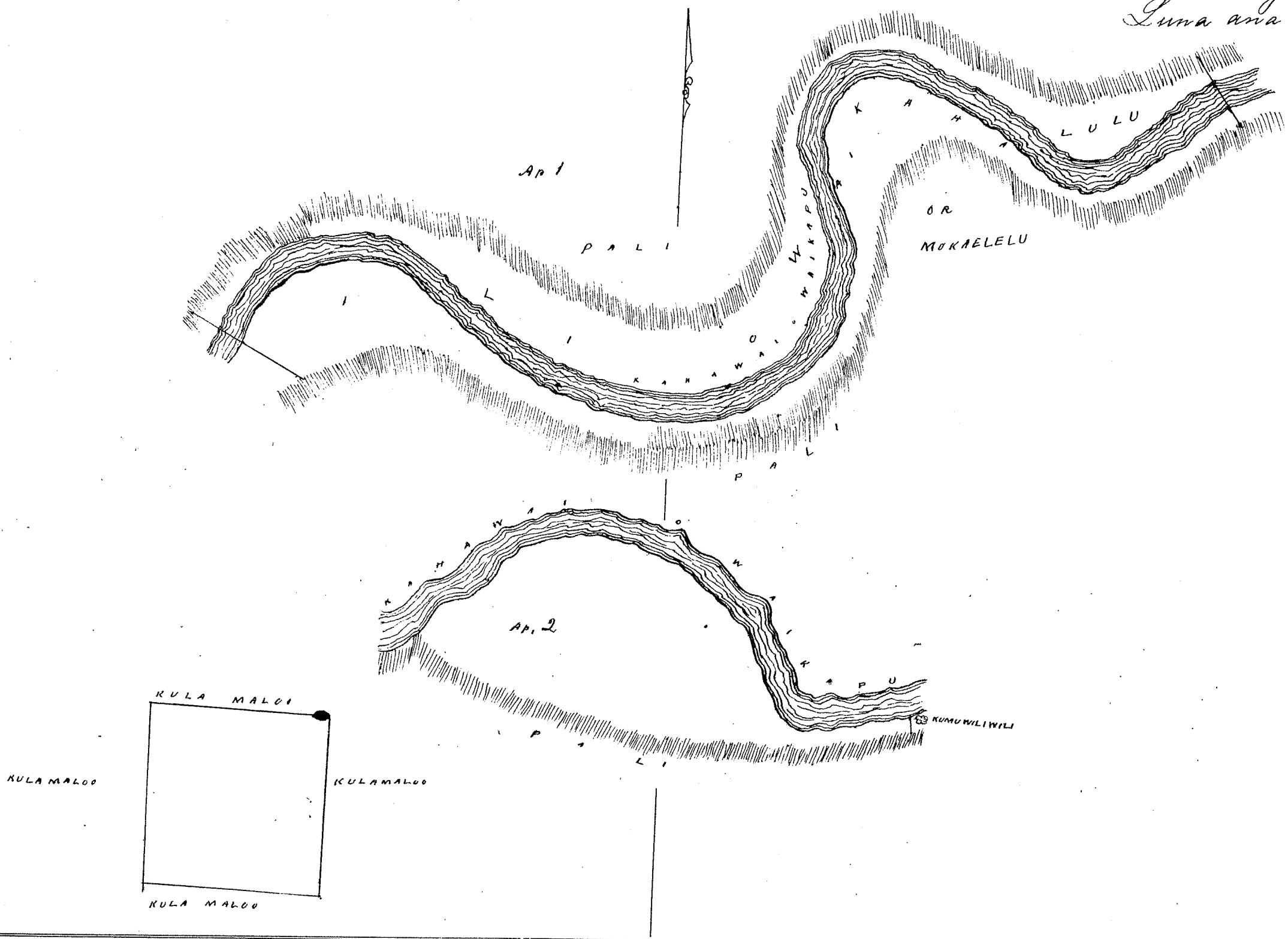

Uka Pua Loa 7
 W. H. Ke
 G. M. Robertson
 J. H. Smith
 J. Kaulahas

Honolulu, 27, Sept. 1852.

Apana 1. pahala - ili o Kaopala, - aole o Pili'pili
 E hoomaka ma ke kahi Akau, e pili ana me Makuakane, a e holo, Nem. 7.° No. 119 Kk.
 e pili ana me Hakiki, Ak. 74 3/4. No. 116 Kk. e pili ana me Hakiki & Kula, Ak. 12 3/4.
 Ki. 50. Kk. e pili ana me Heawe, Ak. 65.° Ki. 2,00 Kk. e pili ana me Makuakane, i kahi
 i hoomaka'i - 1/5 Eka.

Apana 2. ili o Pili'pili, E hoomaka ma ke kahi Akau, oia ke kahi Kula o Ke
 Kekelaiaku, a e holo, Nem. 71.° Ki. 2,12 Kk. e pili ana me Konohia, Nem. 10 1/2.° No. 3 1/4
 Kk. e pili ana me Konohia, Nem. 89.° No. 68 Kk. e pili ana me Pupuahoe, Nem. 4.
 Nem. 55 Kk. e pili ana me Pupuahoe, Nem. 89.° Ki. 68. Kk. e pili ana me Pupuahoe,
 Nem. 1/4.° No. 3,16 Kk. e pili ana me Pupuahoe, Ak. 11 3/4.° No. 2,66 Kk. e pili ana
 me ke Kahawai, Ak. 3 3/4.° Ki. 4,90 Kk. e pili ana me Kekelaiaku, i kahi i hoo-
 maka'i - 1 Eka.

Apana 3. ili o Pili'pili - he mau loi o Kula,
 E hoomaka ma ke kahi Kom. Kema, e pili ana me Kukeleloa, a e holo, Ak. 22 1/4.° Ki. 610
 Kk. e pili ana me ka auwai, Nem. 69.° Ki. 1,25 Kk. oia ke Kula, Nem. 13.° No. 5,34 Kk.
 e pili ana me ke Kula, Ak. 79 1/2.° No. 2,23 Kk. e pili ana me ke Kukeleloa, i kahi i hoo-
 maka'i - 95/100 Eka.

Wailuku, Aug. 14, 1852.

E. Bailey
Mea ana aima

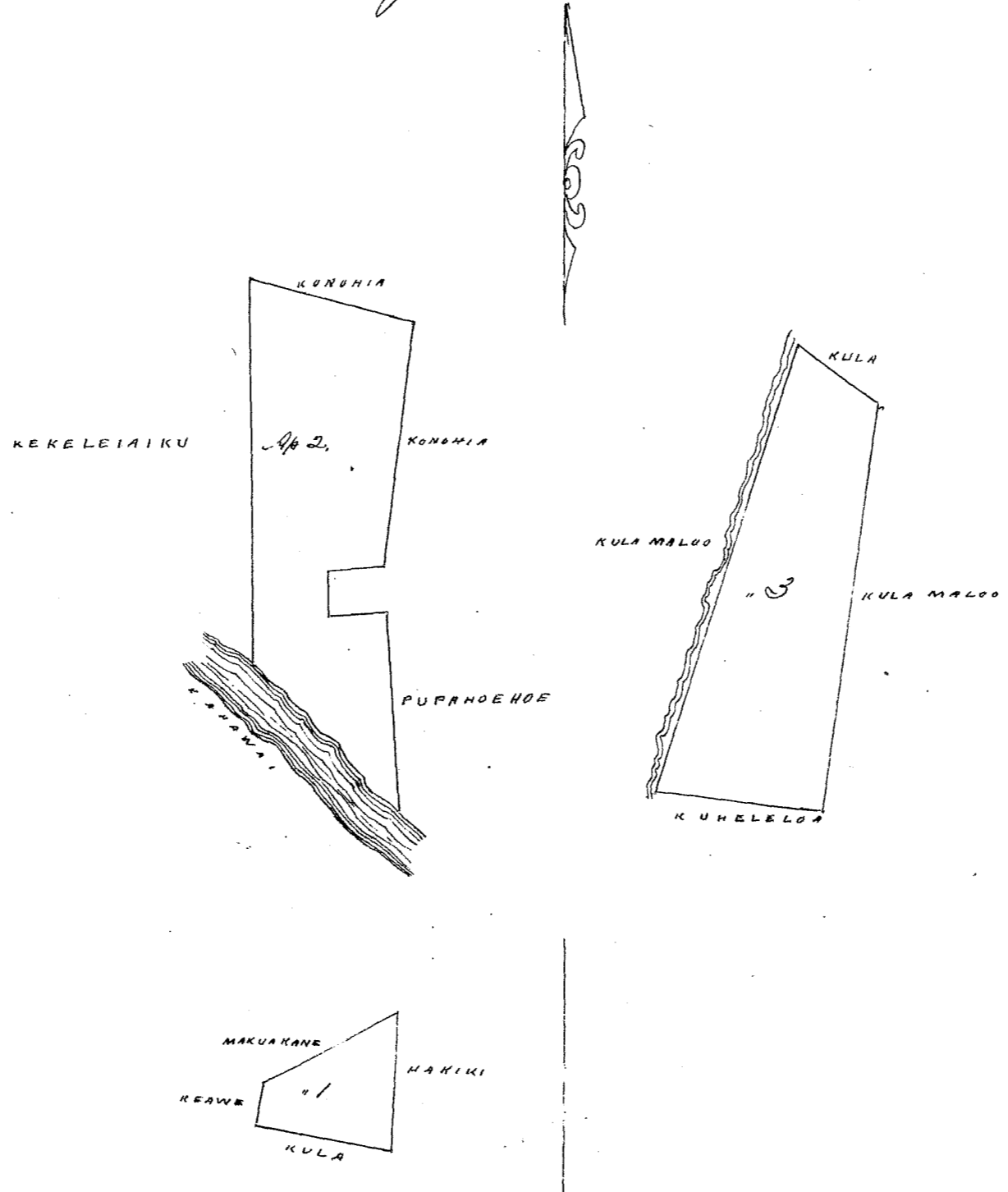

Wai Pau Lra # 5.

W. H. Bee
 G. M. Robertson
 J. H. Smith
 J. Kaulahau

Honolulu, Sep. 27, 1852

Palapala no ke ana ana i ke Pule ana 1759 no Kaupa, Wailuku Motuhau, Maui.
 Apana 1. Ili. Motuhau, Choomaka ma ke kahi Akaui, i pili i ke Kaunwai, &
 Opunui, E holo ana, Sem. 45° 30' No. 3,93 Kk. ma ke Opunui, Sem. 32° 45' No. 127 Kk. ma ke Pa-
 lina, Ak. 45° 15' No. 170 Kk. ma ke Opunui, Sem. 39° 30' No. 197 Kk. ma ke Opunui,
 Ak. 53° 30' No. 0,98 Kk. ma ke Opunui, Sem. 33° 30' No. 190 Kk. ma ke Opunui, Sem. 57°
 No. 0,70 Kk. ma ke Opunui, Sem. 32° 30' No. 118 Kk. ma ke Opunui, Ak. 55° No. 180 Kk.
 ma Kahawai, Ak. 36° 30' No. 292 Kk. ma ke Palina, Ak. 28° 15' No. 3,70 Kk. ma ke Ka-
 unwai, a puni maloko oia Apana, 1 2/3 Eka.

motuhau
 E. 20
 4.60
 1.60

Apana 2. Ili. Puaka, (alua mahala) Mahala 1. Noomaka ma ke kahi Komo-
 hama, e pili ana i ke alani, & ke Ili, E holo ana, Sem. 43° No. 2,30 Kk. ma ke Ke Ili
 Ak. 47° No. 2,00 Kk. ma ke Kawaiilihi, Ak. 43° No. 2,30 Kk. ma ke Palina, Sem.
 47° No. 2,00 Kk. ma ke alani, Aupuni, Maloko oia Apana, 1 6/10 Kk.

1.30
 E. 2.50
 6.25
 1.10
 2
 2.30
 1.53.40

Mahala 2. Noomaka ma ke kahi Komo-hama, e pili ana i ke Ke Ili, E holo ana,
 Ak. 23° No. 1,70 Kk. ma ke Ke Ili, Ak. 55° No. 100 Kk. ma ke Kawaiilihi, Ak. 23° No. 1,70 Kk.
 ma ke Kawaiilihi, Sem. 55° No. 100 Kk. ma ke Ke Ili a puni, Maloko oia Apana, 1 6/10 Kk.

Apana 4. Ili. Umie, Choomaka ma ke Komo-hama, e pili ana i ke Kahawai,
 & Napela, E holo ana, Ak. 8° No. 300 Kk. ma ke Kahawai, Ak. 35° 30' No. 3,73 Kk. ma
 ke Malaihi, Sem. 53° No. 0,90 Kk. ma ke Palina, Sem. 33° No. 2,14 Kk. ma ke Palina
 Sem. 47° No. 1,61 Kk. ma ke Palina, Ak. 50° 45' No. 2,78 Kk. ma ke Palina Sem. 34° No. 1,00
 Kk. ma ke Chule, Sem. 55° 30' No. 2,30 Kk. ma ke Napela, Sem. 37° No. 0,66 Kk. ma ke
 Napela, Sem. 54° 30' No. 0,95 Kk. ma ke Napela, Ak. 38° No. 0,65 Kk. ma ke Napela,
 Sem. 55° 30' No. 3,00 Kk. ma ke Napela, a puni, Maloko oia Apana, 1 3/4 Eka.

Apana 5. Kepuhakoo Wa haale oia

Apana 6. Halaula 2, Choomaka ma ke kahi Akaui, e pili i ke
 Napela, e holo ana, Sem. 58° No. 0,58 Kk. ma ke Napela, Sem. 27° 15' No. 100 Kk. ma ke
 Napela, Ak. 58° No. 0,40 Kk. ma ke Napela, Ak. 27° 15' No. 162 Kk. ma ke Kawaiilihi,
 Ak. 58° No. 0,38 Kk. ma ke Napela, Ak. 27° 15' No. 162 Kk. ma ke Napela, Sem. 58°
 No. 0,20 Kk. ma ke Napela, Ak. 27° 15' No. 100 Kk. ma ke Napela, a puni,
 Maloko oia Apana, 1 1/2 Kk.

Apana 7. Ili. Kalua, Wa Puai ia alua oia,

Apana 8. Ili. Halaula, 1. (alua mahala) Mahala 1.
 Noomaka ma ke kahi Komo-hama, e pili ana i ke alani, & Apiti, E holo ana, Ak. 32° 30' No. 1,76
 Kk. ma ke Apiti, Ak. 53° No. 1,23 Kk. ma ke Apiti, Sem. 29° No. 1,70 Kk. Sem. 57° No. 1,14
 Kk. ma ke Maui, a puni, Malala 2, Kk.

Mahala 2, Choomaka ma ke kahi Kikina, pili ia Apiti & Meau, E holo ana
 Ak. 41° No. 1,76 Kk. ma Meau, Sem. 45° 30' No. 1,80 Kk. ma Kahawai, Sem. 27° No. 0,86 Kk.
 ma Malala, Ak. 60° 30' No. 1,00 Kk. ma Apiti, Ak. 74° No. 1,13 Kk. ma Apiti a puni
 Malala 2 3/10 Kk.

Apana 9. Pauhale, Noomaka, kahi Kikina pili i Kahawai, & pili
 E holo ana, Sem. 46° 45' No. 8,00 Kk. ma Palina, Ak. 51° 45' No. 3,94 Kk. ma Kono Ak. 52°
 45' No. 8,00 Kk. ma Kahawai, Sem. 53° 15' No. 4,45 Kk. ma Kai a puni, Malala 3 1/4 Eka.

A. Keohokalole,
 Mea ana.

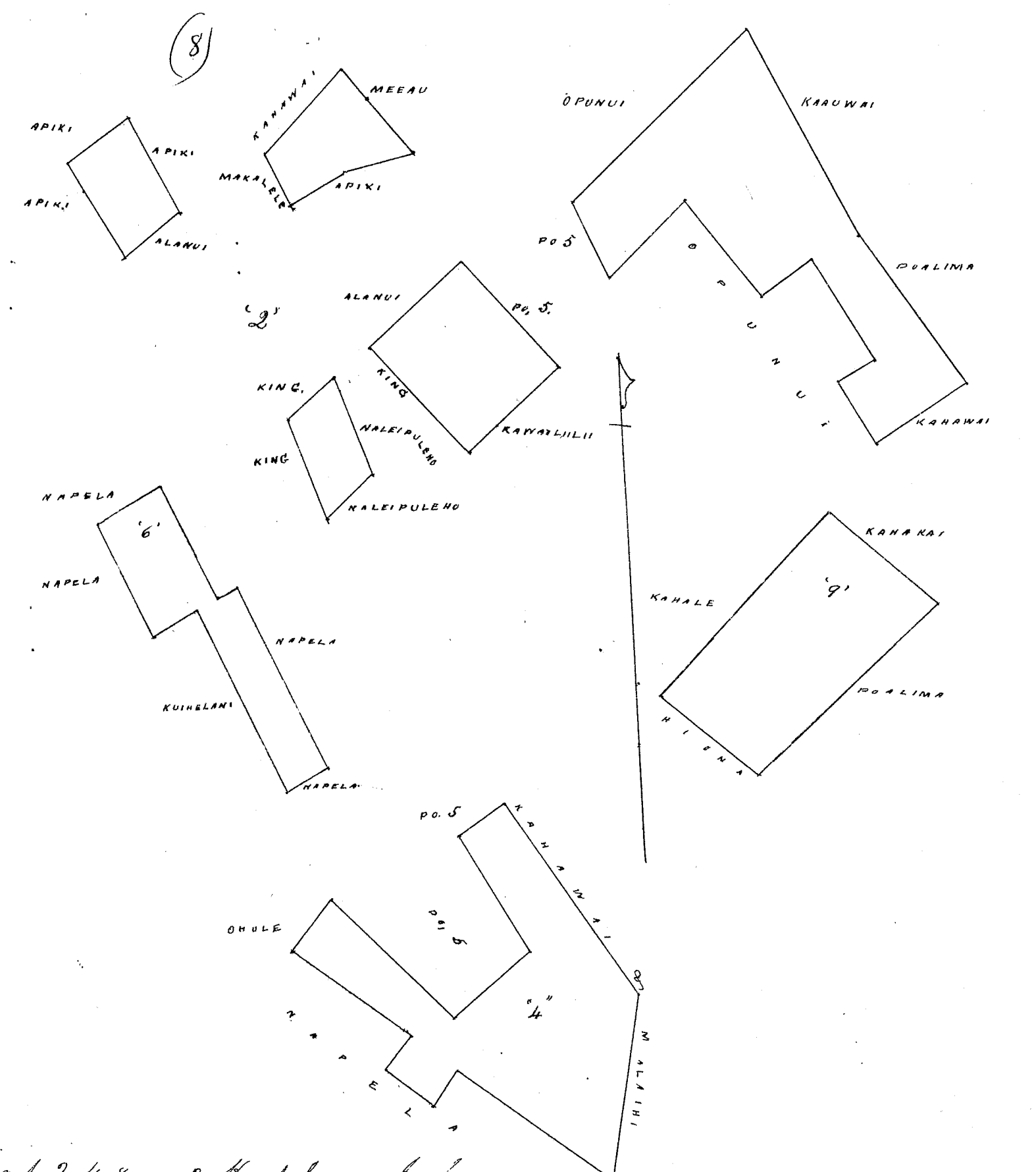

Apana 1, 2, 4, 8 = 2 Kaulahas - 1 Ipiha
 Apana 6 = 1 Kaulahas " "
 Apana 9 = 4 Kaulahas " "

Wm Pau Loa \$10.
 W. L. Lee
 G. W. Robertson
 J. Kaulahas
 C. H. Smith

Honolulu 27 Sep, 1852.

Kulu 2428 Kaowao Wailuku Maui

Palapala no ke ana ana i ke Kulanā 2428 Kāwao, ma ka ili o Omikeu, Wailuku, Moku o Maui. E hōma ka ana ma ke Piki Komohana, e pili ana i ke Kawaihia, E holo ana, Nui. 56.45, Ki. 5.00 Kh. ma Kawaihia, Nui. 15.30, Ki. 2.80 Kh. ma Kawaihia, Ak. 51.30 Ki. 2.80 Kh. ma Kahawai, Ak. 54.30 Ki. 6.55 Kh. ma Maunili, Ak. 68, Ki. 2.48 Kh. ma Maunili, Nui. 23, Ki. 1.93 Kh. ma ka pali a puni, Maloko via apana, 2 Eka,

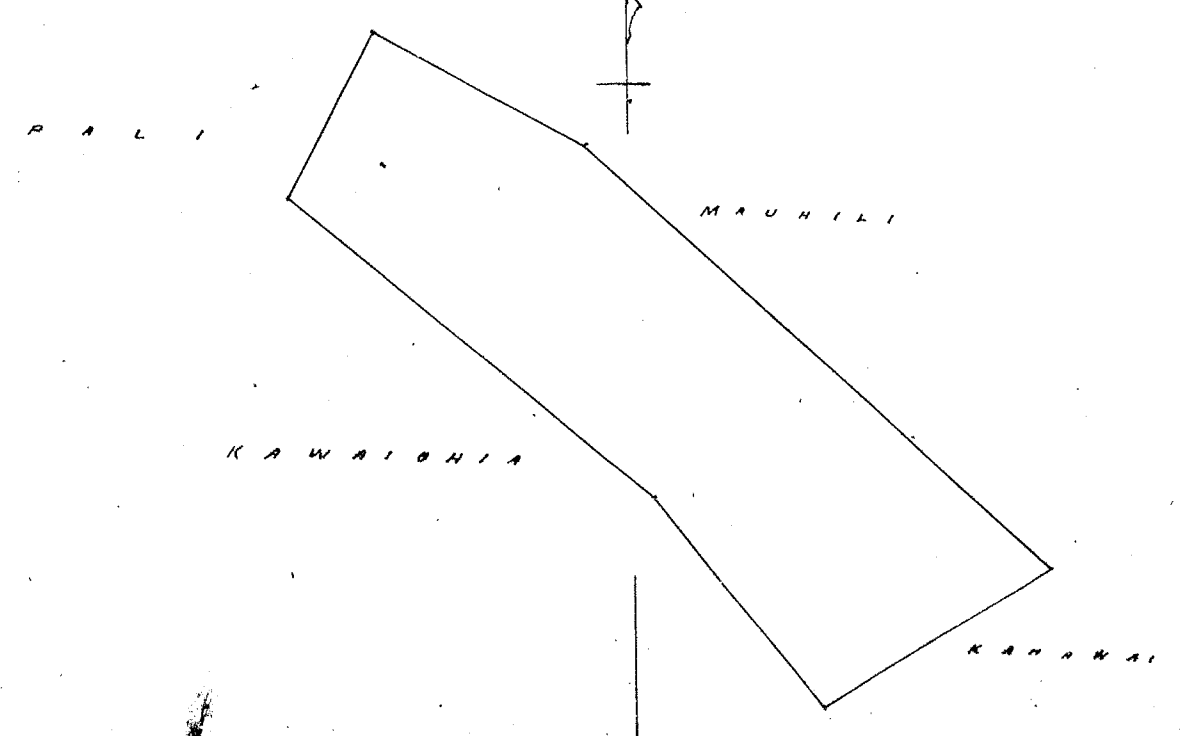

A. Kookabato,
 Mea ana,

Uku Pau Loa # 6.
W. Lee
G. M. Robertson
J. H. Smith
J. Kakaulaho

Honolulu 27 Sep 1852.

Kelu 3231 Opunui

Wailuku Maui

Apaua 1. Ili o Mokuhan. E hoomaka ma ke Pihikomoehana, e pili ana me Kikane, a e holo. Ak. 18 1/2. Ni. 364 Kh. e pili ana me Kaupa & Poalima, Kem. 38 1/2. Ni. 177 Kh. e pili ana me Kaupa & Poalima, Ak. 53 1/2. Ni. 98 Kh. e pili ana me Kaupa & Poalima, Kem. 33 1/2. Ni. 190 Kh. e pili ana me Kaupa & Poalima, Kem. 57. Ni. 69 Kh. e pili ana me Kaupa & Poalima, Kem. 32 1/2. Ni. 159 Kh. e pili ana me Kaupa & Poalima, Kem. 36. Ni. 122 Kh. e pili ana me Mahawai, Ak. 55 1/2. Ni. 260 Kh. e pili ana me Hewahewa, Ak. 75. Kem. 223 Kh. e pili ana me Kikane, Ak. 51. Ni. 145 Kh. e pili ana me Kikane, a hiki ma kahi i hoomaka i 1.72/100 Eka.

Apaua 2. Ili o Keakupio. E hoomaka ma ke kahi Akau, e pili ana me ke Keakupapahi, a e holo. Kem. 48 1/2. Ni. 111 Kh. e pili ana me Kaupali, Kem. 48 1/2. Ni. 554 Kh. e pili ana me Kaupali, Ak. 63 1/2. Ni. 137 Kh. e pili ana me Kaupa & Poalima, Ak. 56. Ni. 190 Kh. e pili ana me Kaupa & Poalima, Ak. 47 1/4. Ni. 126 Kh. e pili ana me Keakupapahi, a hiki ma ke Pihikomoehana 63/100 Eka.

Wailuku, Julai 16, 1852

C. Bailey
Ma ana.

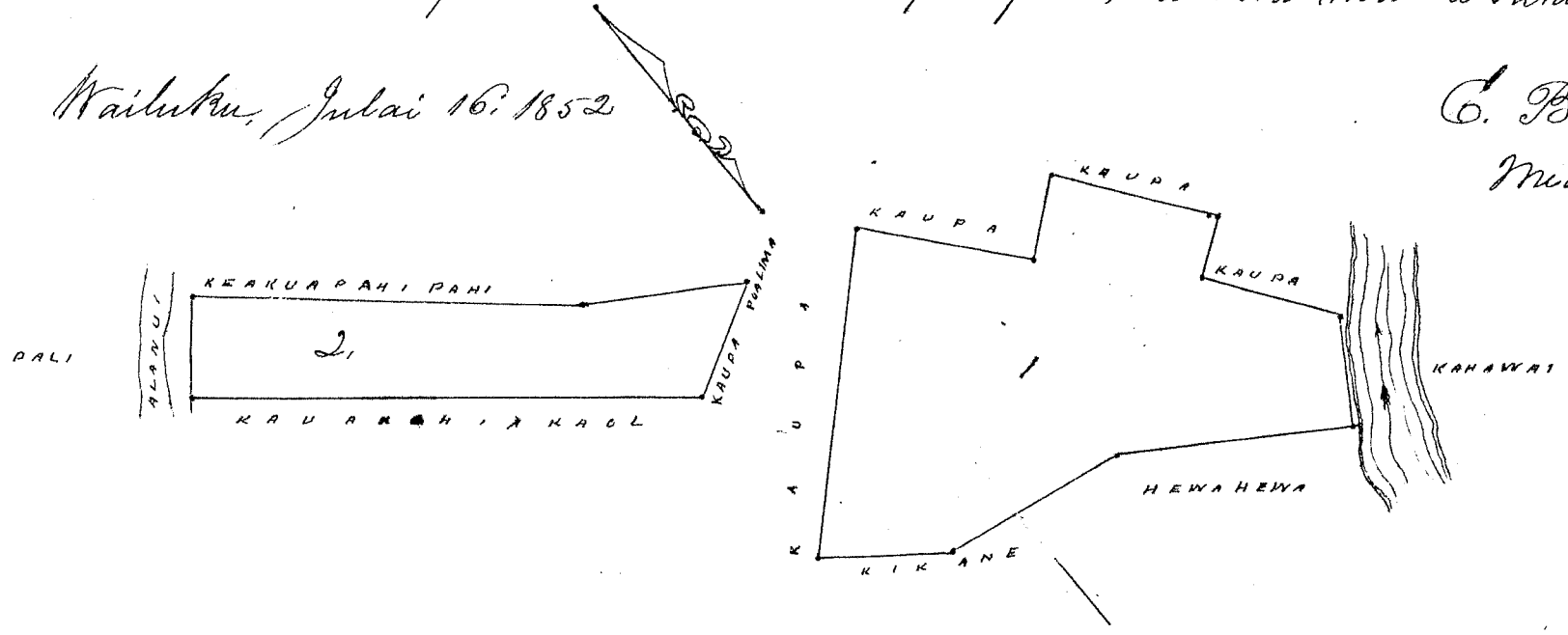

Uku Pau Loa # 5
W. Lee
G. M. Robertson
J. H. Smith
J. Kakaulaho

Honolulu, 27, Sep. 1852.

Kelu 8806 Kealapuna

Waikapu Maui

Apaua 1. Kalo me ka pahale, ma Hapalaalaua. E hoomaka ma ke Pihikomoehana Kem. e pili ana me J. Richardson, a me Kihono, a e holo. Ak. 11 1/2. Ni. 174 Kh. e pili ana me J. Richardson, Ak. 85 1/4. Ni. 705 Kh. e pili ana me Kapahana, Kem. 9. Ni. 187 Kh. e pili ana me Ka auwai, Kem. 85. Ni. 1043 Kh. e pili ana me Kihono, Ak. 7 1/2. Ni. 124 Kh. e pili ana me Ka poalima, Kem. 84 1/2. Ni. 53 Kh. e pili ana me Ka poalima, Kem. 63 1/4. Ni. 123 Kh. e pili ana me Ka poalima, Kem. 85. Ni. 548 Kh. e pili ana me Kihono, a hiki ma ka pahale me, 1.27/100 Eka.

Apaua 2. Kalo ma Aaunui. E hoomaka ma ke Pihikomoehana Kem. ma ka auwai, a e holo. Ak. 14 1/4. Ni. 121 Kh. e pili ana me Ka auwai, Ak. 72 1/2. Ni. 45. Kh. e pili ana me Ke auwani Ioi, Ak. 63 1/4. Ni. 223 Kh. e pili ana me Ke auwani Ioi, Ni. 83. Ni. 677 Kh. e pili ana me Ka iti, Pohakuloa, Kem. 17. Ni. 320 Kh. e pili ana me J. Richardson, Ak. 74 1/2. Ni. 158 Kh. e pili ana me J. Richardson, Ak. 18. Ni. 125 Kh. e pili ana me Ka poalima, Ak. 74 1/2. Ni. 60 Kh. e pili ana me Ka poalima, Kem. 18. Ni. 125 Kh.

e pili ana me ka Poalima Sem. 77° No. 50 Kh. e pili ana me A. Richardson. Sem. 86° No. 363 Kh.
e pili ana me Piipii a hiki ma Kahi i hoomakaa'i = 198/100 Eka.

Wailuku, Aug. 20, 1852

C. Bailey
Mea ana, aina

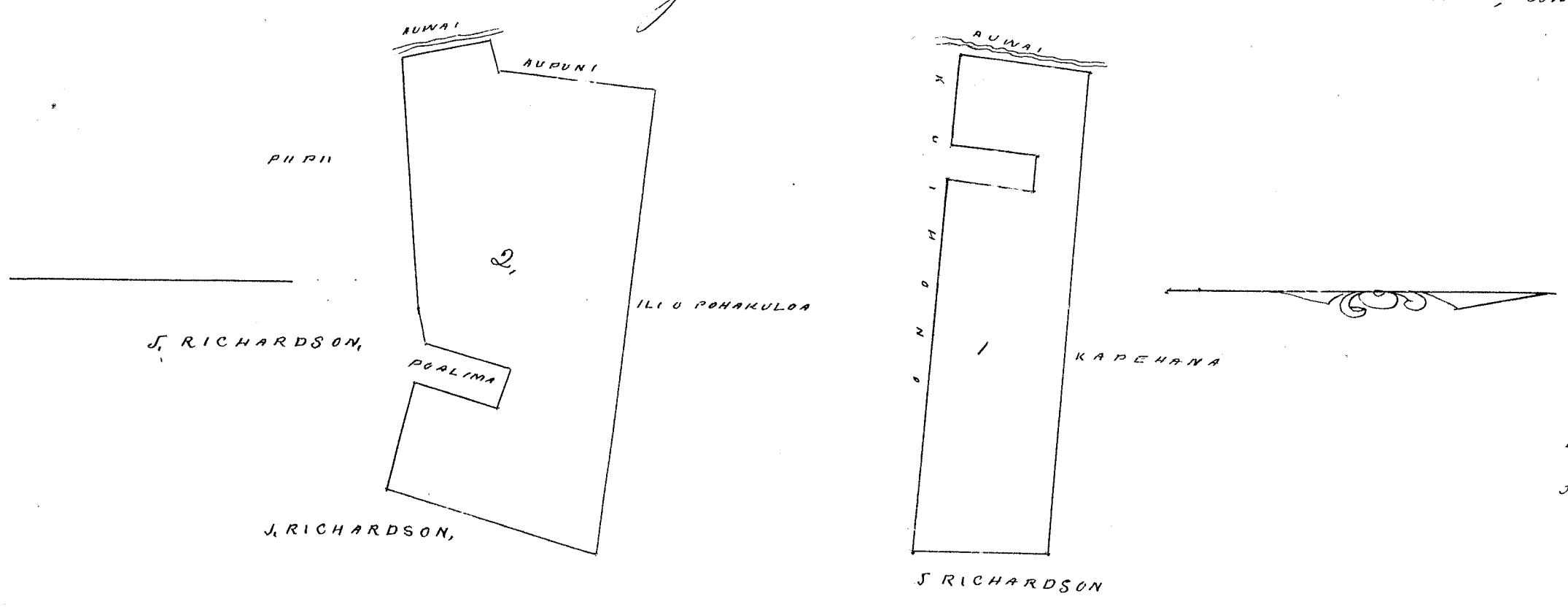

1.27
1.98
3.25

Wm Pau Loa # 6

W. K. K.
G. M. Robertson
J. H. Smith
J. Kekaulahao

Honolulu 27 Sep 1852

Kulu 2577 Hakiki

Wailuku Maui

Kulu 2577 no Hakiki Wailuku Maui;

Apana 1. Ili. Kaopala, Chomakaa ana ke Pihii Akau, e pili ana me Makuaane, a ka
huhu, a e holo, Sem. 13 3/4, Si. 360 Kh. e pili ana me Kahuhu, i ka Waiau, Sem. 7° No. 139 Kh., e
pili ana me Waiau, a me ka Poalima, Sem. 2 1/2, No. 114 Kh. e pili ana me ka Poalima me Humakaa'i
Ak. 7 3/4, No. 220 Kh. e pili ana me Kamakaa'i me Kamohai, Ak. 19 3/4, No. 184 Kh. e pili ana
me Kamohai, me Haawahine, Ak. 15 1/4, Si. 126 Kh. e pili ana me aupuni kula, Sem. 7 1/4, Si. 61 1/2 Kh.
e pili ana me Kaaa, Ak. 7° Si. 179 Kh. e pili ana me Kaaa, Ak. 65° Si. 60 Kh. e pili ana
me ka Makuaane, i kahi i hoomakaa'i = 198/100 Eka.
1.66

Poalima i loko oia Apana, mai ke Pihii hema mai, ka pahala Kaaa, e ana, Sem. 7 1/2°
Si. 82 Kh. i ke Pihii mua, aiaa holo, Sem. 6 3/4, Si. 51 Kh. Sem. 21°, No. 82 Kh. Ak. 69° No. 57 Kh.
Ak. 25° Si. 78 Kh. pumi, 1/100 Eka.

Apana 2, Ili o Olohe, Chomakaa ana ke Pihii Akau, e pili ana me Chumui,
a Kahakumakaa'i, a e holo, Sem. 6 1/2, Si. 220 Kh. e pili ana me Kahakumakaa'i, a e, Sem. 19 1/4,
No. 136 Kh. e pili ana me ka aina kula, Ak. 71° No. 80 Kh. e pili ana me ka aina kula, Ak. 16°
Si. 53 Kh. e pili ana me ka aina kula, Ak. 69° No. 138 Kh. e pili ana me ka aina kula,
Ak. 20 1/4, Si. 96 Kh. e pili ana me ka Chumui, i ke Pihii mua 1/4 Eka.

Apana 1. Ili o Waihalulu, Chomakaa ana ka auwai kahi Komohana, e pili
ana me Kaha, a e holo, Ak. 85 1/2, Si. 226 Kh. e pili ana me Kaha, Sem. 13 1/2, Si. 112 Kh.
e pili ana me ka aina kula, Ak. 86° No. 200 Kh. e pili ana me ka aina kula, Ak. 34 1/2 No.
97 Kh. e pili ana me ka aina kula, i kahi i hoomakaa'i = 1/100 Eka.

Wailuku, Aug 16, 1852

C. Bailey
Mea ana aina

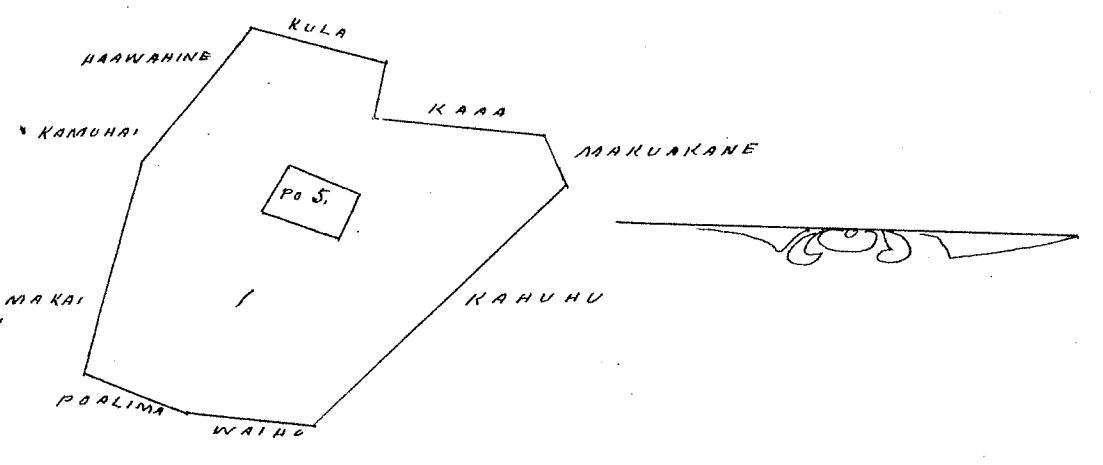
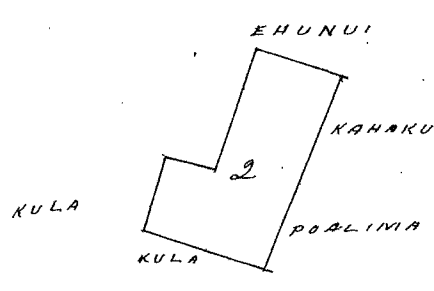
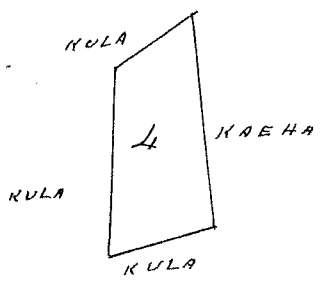

Wm Pan Low # 5,
 Wm
 G. M. Robertson
 J. H. Smith
 J. Kakaubaka

Honolulu 27 Sep. 1852.

Volu 3527 Kamohai

Kaikapu Maui.

No ke Kwai aku Kwai mai, wa haule Kikahi mau apawa,
 Apawa 1. Ili o Katoapuku. E hoomaka ma ke Pihia Akau, e pili ana me ke Haawahine, a e holo, Nema 44° N: 201 Kaulahao, e pili ana me C. Copp, Nem. 50° N: 150 Kk. e pili ana me ke Ma-huka, Ak. 34 1/2° N: 174 Kk. e pili ana me ke Kula malo, Ak. 41° N: 125 Kk. e pili ana me Haawahine a hiki ma ke Pihia mua = 1/4 Eka.

Apawa 2. Ili o Kaalaea. E hoomaka ma ke Pihia Akau, e pili ana me ke Kaai, a e holo, Nem. 53 1/2° N: 246 Kk. e pili ana me Kaai, Nem. 20 1/2° N: 75 Kk. e pili ana me Kaai, Ak. 62° N: 244 Kk. e pili ana me Kaai, Ak. 23° N: 111 Kk. e pili ana me Kaai, a hiki ma ke Pihia mua 1/5 Eka.

20.
20
40

Apawa 3. Ili o Kuaalaea. E hoomaka ma ke Pihia Nihina e pili ana me ke Kapa, a e holo, Nem. 25° N: Kaulahao 92, Kaulahao, e pili ana i ka poalima, Ak. 59° Nem. 290 Kk. e pili ana me Kaanaa, Ak. 7 1/2° N: 143 Kk., e pili ana me ke Kula malo, Nem. 23 3/4° N: 87 Kk. e pili ana me Keakua, Nem. 59° N: 266 Kk. e pili ana me Kaanaa, a hiki ma ke Pihia mua = 1/5 Eka.

Apawa 6. Ili o Kaopala. E hoomaka ma ke Pihia Akau, e pili ana me Haawahine a e holo, Nem. 49 3/4° N: 96 Kk. e pili ana i ka Pihia; Nem. 43 1/2° Nem. 110 Kk. e pili ana i Kama-kai, Ak. 40° N: 105, e pili ana me ka poalima, Ak. 40 1/2° N: 96 Kk. e pili ana me Haawahine a hiki ma ke Pihia mua = 1/10 Eka.

Apawa 10. Paakai ma Kealia. E hoomaka ma ke Pihia Nihina Nema, e pili ana me Keakua, a e holo, Ak. 82 3/4° N: 157 Kk. e pili ana me Aupuni, Nema 3° N: 352 Kk. e pili ana me Poalima, Ak. 85 3/4° N: 167 Kk. e pili ana me ke Keakua, Ak. 1 1/2° N: 318 Kk. e pili ana me ke Keakua, a hiki ma ke Pihia mua = 5 1/4 Eka.

54
30
84

Apawa 7. Pahale. E hoomaka ma ke Pihia Nema, e pili ana me Kawana, a e holo, Ak. 36° N: 68 Kk. e pili ana me Kawana, Ak. 12 3/4° N: 270 Kk. e pili ana me Keawe, Nem. 74 3/4° N: 115 Kk. e pili ana me Kapa, Nem. 15 1/4° N: 126 Kk. e pili ana me Katoapuku, Nem. 49 3/4° Nem. 26 Kk. e pili ana me Katoapuku; Nem. 39° N: 169 Kk. e pili ana me Haawahine, a hiki ma ke Pihia hoomaka i 3/10 Eka.

Waialua, Aug 18, 1852

C. Bailey
 Ma Ana

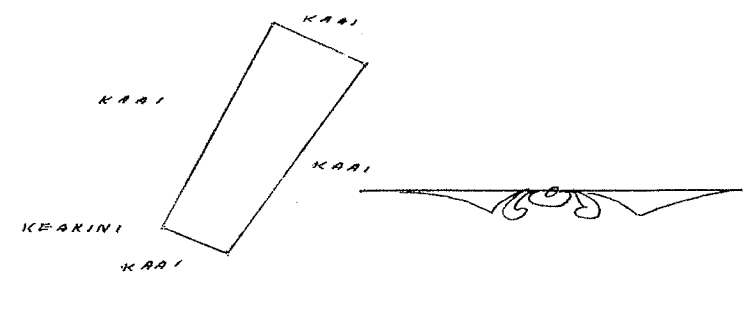
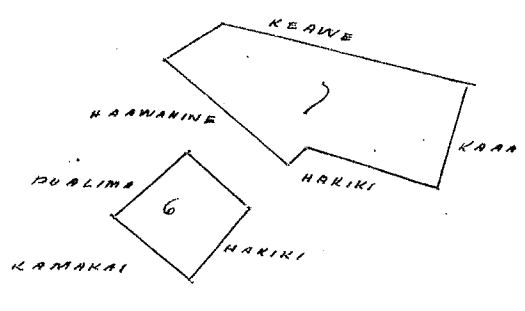
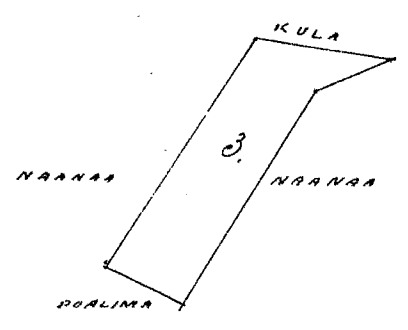

2 Kth. = 1 In.

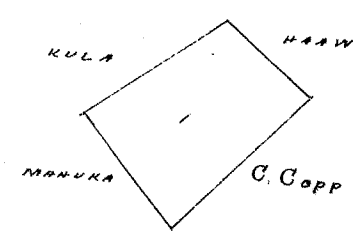
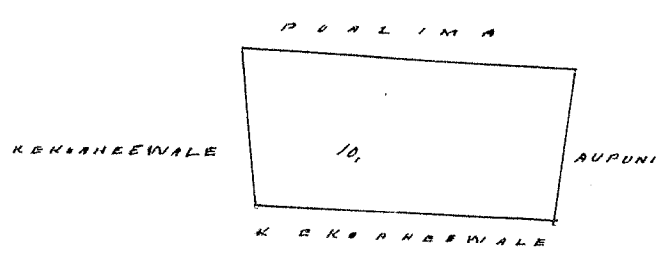

Uku Pau Loa # 5.
 W. H. Ke
 G. M. Robertson
 J. St. Smith
 J. Kekaulahas

Honolulu, 27, Sep 1852.

Heleu 3371 Naku

Hanamaulu Hawaii

Aina Kala Kula me pahale, maheka ka ili o Kapalaia, Hanamaulu, Puna, Hawaii.
 Puni owa Mokuana, Chromaka ana owa kahi pahu laau, owa kahi auwai, kokeke i ke Kahawai o
 Hanamaulu, owa ke Papa Aema, alaia aku, Nem. 56, Sika. 1 50/100 Kaul. e pili ana i ke Kula
 o Konohiki, Nem. 18, Kom. 2 64/100 Kth. e pili ana i ke Kula o Konohiki, Nem. 79, Sika. 2 40/100 Kth.
 e pili ana me ke Kula o Konohiki, Nem. 22, Kom. 1 50/100 Kth. e pili ana me ke Kula o Konohiki,
 Ak. 66, Kom. 2, Kth. e pili ana me ke Kula o Konohiki, Nem. 15, Sika. 2 75/100 Kth. e pili ana me
 ke Kula Konohiki, Nem. 15, Kom. 1, Kth. e pili ana me ke Kula Konohiki, Ak. 24, Kom. 3 30/100
 Kth. e pili ana i ke Kahawai o Hanamaulu, Ak. 5, Kom. 3 52/100 Kth. e pili ana me ke Kahawai
 o Hanamaulu, Ak. 10, Nem. 1 90/100 Kth. e pili ana me kahi auwai, Eili ana i Eka,
 1 Puda, 19 Perka.

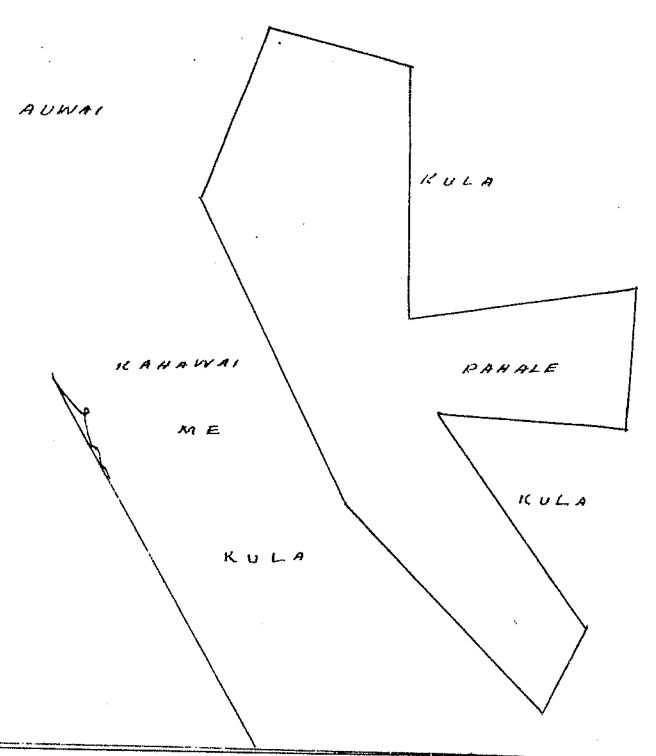

2 Kth. = 1 In.

Hawaii Sept. 3, 1852

W. H. Ke
 G. M. Robertson
 J. St. Smith
 J. Kekaulahas

Uku Pau Loa # 5.
 W. H. Ke
 G. M. Robertson
 J. St. Smith
 J. Kekaulahas

Honolulu, 5, Oct 1852

Kulu 3647 Kapuohi

Hanamaulu Kawaii

Maloko o ke Ahupuaa o Hanamaulu, Puna, Kawaii,

Apana 1. Pahale, maloko o ke Kuu o Papuaa, Penei ma Mokuna, E hoomaka ana ma ka pali; ma kahi laau laau, abaila, Hem. 30° Nih. 1.75/100 Kahu, e pili ana i ke Pula o Honohiki, Hem. 60° Nih. 1.30/100 Kahu, e pili ana i ke Kahawai, Ak. 30° Nih. 1.75/100 Kahu, e pili ana i ke Kula Honohiki, Ak. 60° Nih. 1.30/100 Kahu, e pili ana ma ka pali; e ili ana 38 Perka,

Apana 2. Aina Kalo maloko o ka ili o Moala, Penei ma Mokuna, E hoomaka ana ma ka pali ma kahi pahu laau, abaila, Hem. 20° Nih. 2.65/100 Kahu, e pili ana i ke Koele, Ak. 68° Nih. 9.50/100 Kahu, e pili ana i ka pali ma ke Pula, Ak. 20° Nih. 2.65/100 Kahu, e pili ana i ke Pula o Honohiki, Hem. 68° Nih. 9.50/100 Kahu, e pili ana i kahi auwai ma Kula, e ili ana 2 Eka, 2 Puda,

Apana 3. Aina Kalo ma ka ili o Moala, Penei ma Mokuna, E hoomaka ana ma ka pali ma kahi pohaku, abaila, Hem. 42, Hem. 5 Kahu, e pili ana i ka aina o Kaneakali, Hem. 37° Nih. 4.70/100 Kahu, e pili ana i ke Pula o Honohiki Hem. 28° Nih. 3.25/100 Kahu, e pili ana i ke Pula o Honohiki, Ak. 58° Nih. 2.50/100 Kahu, e pili ana ma ke Pula o Honohiki, Ak. 34° Hem. 2.46/100 Kahu, e pili ana i kahi Koele, Ak. 60° Nih. 1.20/100 Kahu, e pili ana i kahi Koele, Hem. 34, Nih. 2.46/100 Kahu, e pili ana i kahi Koele, Ak. 60° Nih. 1.68 Kahu, e pili ana i ka pali; e ili ana 1 Eka 2 Puda 32 Perka,

Kawaii, Sept. 3, 1852

W. A. Pease

38
22 -
12 32
41.30

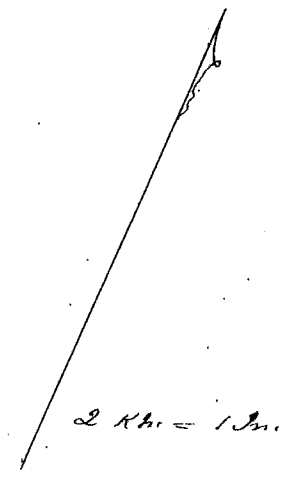
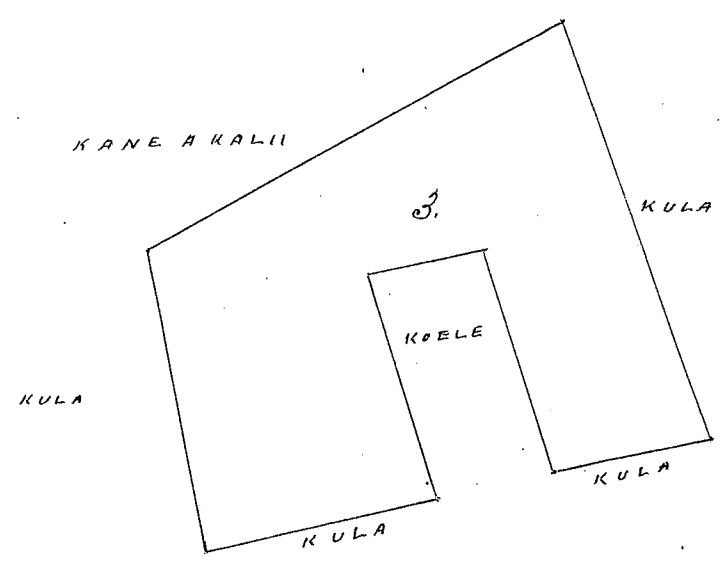
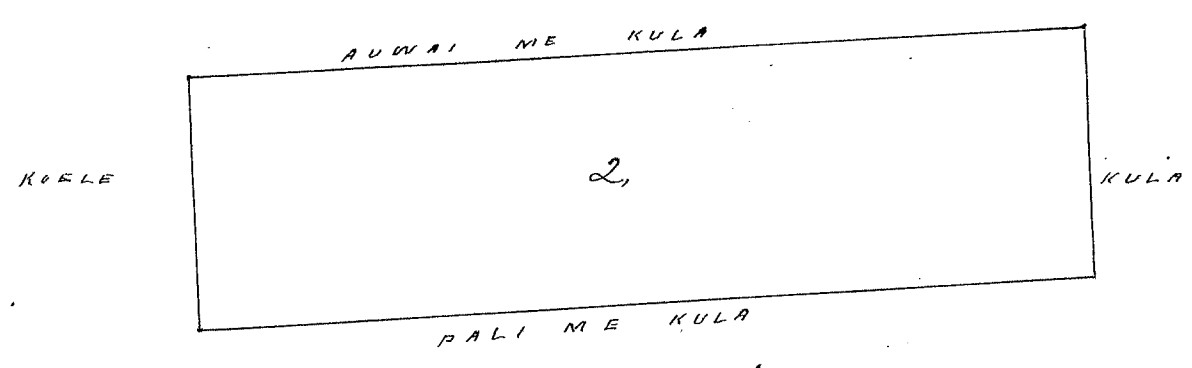
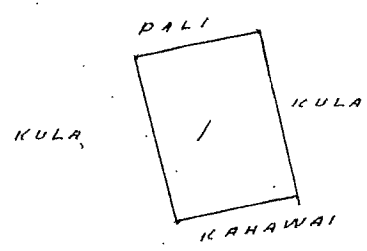

W. L. Lee

W. L. Lee
S. M. Robertson
J. K. Kaulahao
J. H. Smith

Honolulu, 5. Oct. 1852.

Akahi moos Kaulaloo, ka inoa maloko ka ili o Kaulaloo, Ahupuaa o Waimoa Kawaii, Peni na mokuna, E hoomaka ma ka auwai o Pelekai, Kama, Kom. o Kahi Kooli, alaila aku, Kama 75' Siki. 11 Kaul. e pili ana ina Loi o Kaulaloo, Akau. 15' Siki. 1 20/100 Kaul. e pili ana i ka auwai, Akau. 75' Kom. 11 Kaul. e pili ana ina Loi o Kaulaloo, Akau. 15' Kom. 12 20/100 Kaul. e pili ana i ke kahawai o Waimoa, e ili ana 1 Eka, 1 Ruda 10 Perka.

Kawaii Sept. 3, 1852.
W. A. Pease

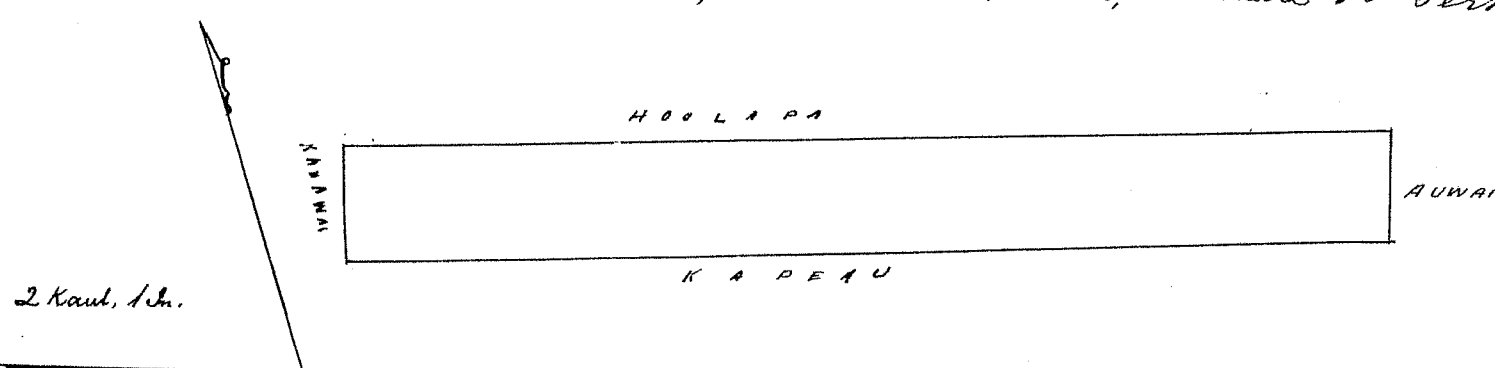

Uku Pau Loa # 5
W. A. Pease
G. M. Robertson
J. H. Kaulaloo
J. H. Smith

Honolulu 5 Oct. 1852

Akahi moos Kaulaloo, maloko ka ili o Kaulaloo, Kona Kawaii, Peni na mokuna, E hoomaka ma ka auwai o Pelekai, Kama, Kom. o Kahi Kooli, alaila aku, Kama 75' Siki. 11 Kaul. e pili ana ina Loi o Kaulaloo, Akau. 15' Siki. 1 20/100 Kaul. e pili ana i ka auwai, Akau. 75' Kom. 11 Kaul. e pili ana ina Loi o Kaulaloo, Akau. 15' Kom. 12 20/100 Kaul. e pili ana i ke kahawai o Waimoa, e ili ana 1 Eka, 1 Ruda 10 Perka.

Kawaii Sept. 3, 1852

W. A. Pease

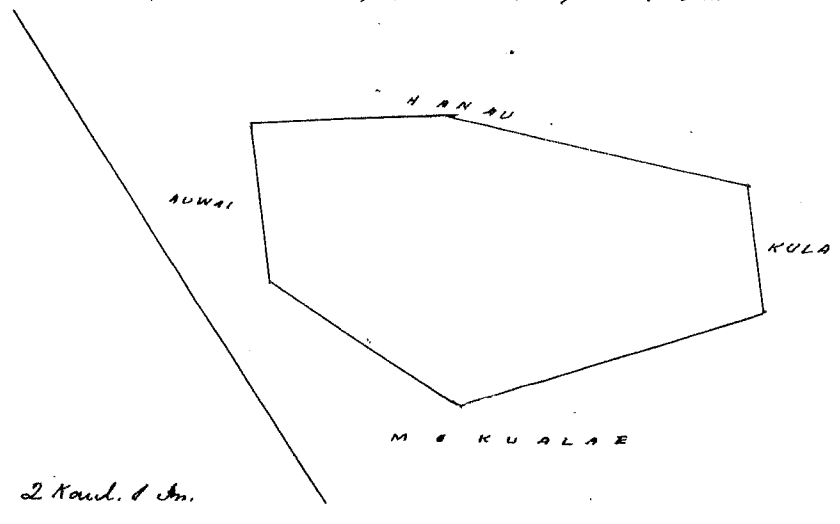

Uku Pau Loa # 5
W. A. Pease
G. M. Robertson
J. H. Kaulaloo
J. H. Smith

Honolulu 5 Oct. 1852

Aina kaulaloo "Kapaiki" ka inoa maloko ka ili o Kapaiki, Ahupuaa o Hanapepe Kona Kawaii, Peni na mokuna, E hoomaka ma ka auwai o Pelekai, Kama, Kom. o Kahi Kooli, alaila aku, Kama 75' Siki. 11 Kaul. e pili ana ina Loi o Kaulaloo, Akau. 15' Siki. 1 20/100 Kaul. e pili ana i ka auwai, Akau. 75' Kom. 11 Kaul. e pili ana ina Loi o Kaulaloo, Akau. 15' Kom. 12 20/100 Kaul. e pili ana i ke kahawai o Waimoa, e ili ana 1 Eka, 1 Ruda 10 Perka.

Kawaii Sept. 3, 1852

W. A. Pease

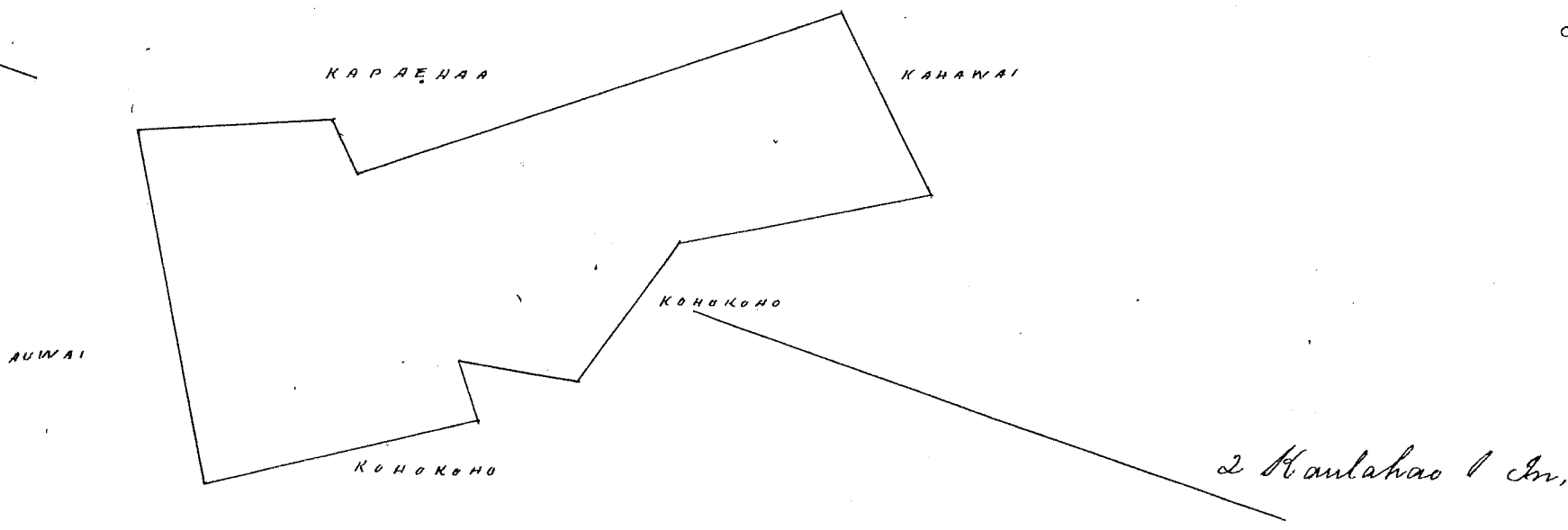

Uku Pau Loa # 6.
 W. L. Lee
 G. M. Robertson
 J. Kekaulaha
 J. H. Smith

Honolulu 5 Oct 1852.

Ulu 336 Wakapu

Koia Kona Hawaii

Maloko i ke Ahupuaa o Kona Kikina, Kona Hawaii

Apana 1. Aina Kalo "Haluaalamiki" Ka inoa "Puni" na onokuna. E hoomaka ana ma ma Loi o Namanu, ma ke Pihia Nima Komohana, Akau 23, Komohana 1²⁴/₁₀₀ Kaulahao, e pili ana ma Loi o Namanu, Akau 70, Komohana 1¹⁴/₁₀₀ Kaulahao, e pili ana ma ma Loi o Namanu, Akau 86, Komohana, 40 pautu, e pili ana ma Loi o Konoiki, Nema, 11, Komohana 1³⁰/₁₀₀ Kaulahao, e pili ana ma Loi o Konoiki, Nema, 13, Kikina 2 Kaulahao, e pili ana i ka auwai o Maulili, Ak. 73, Kikina 2⁵/₁₀₀ Kaulahao, e pili ana ma Loi o Konoiki, Ak. 27, Kikina 85 pautu, e pili ana ma Loi o Konoiki, e ili ana 2, Ruda, 8, Perka.

Apana 2, akahi Loi ma Pahale, maloko o ka ili o Kikina, E hoomaka ana ma kahi papohaku, ma Kula o Konoiki, Akau 66, Kikina 2⁵⁰/₁₀₀ Kaulahao e pili ana i kahi papohaku, ma Kula, Akau 12, Kikina, 1²⁵/₁₀₀ Kaulahao, e pili ana i ke Kula o Konoiki, Akau, 78, Komohana, 3³⁰/₁₀₀ Kaulahao, e pili ana i ke Kula o Konoiki, Nema, 15, Komohana 1 Kaulahao, e pili ana i ke Kula o Konoiki, Nema, 64, Kikina, 60 pautu, e pili ana i kahi papohaku, Nema 12, Kikina, 1³¹/₁₀₀ Kaulahao, e pili ana i kahi papohaku, e ili ana 2 Ruda, 16 Perka.

Kanai Sept. 3, 1852
 W. H. Pease,

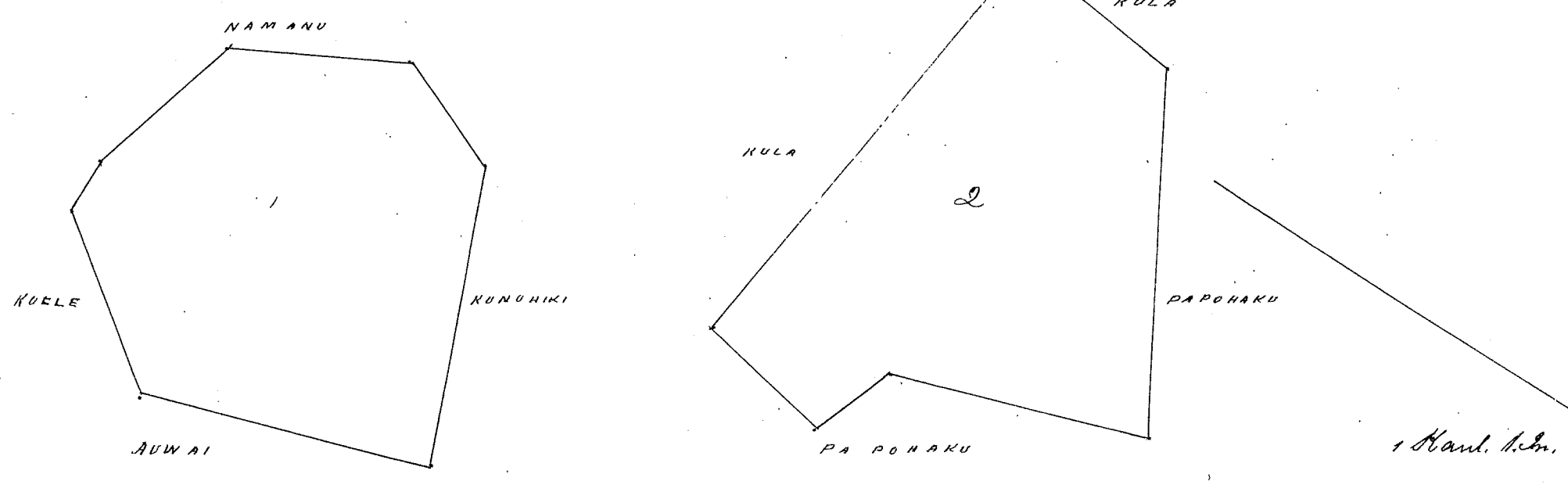

Uku Pau Loa # 5.
 W. L. Lee
 G. M. Robertson
 J. Kekaulaha
 J. H. Smith

Honolulu, 5, Oct. 1852.

Apana 1. Aina Kalo Pahale & Kula, maloko ka ili o Kapalau Nihina, Ahupuaa o Koloa, Nihina Kona Kauai, Penei ma motuana. E hoomaka ana ma ka auwai o Kapalau, ma ke Pihiki Nema, Komohana o Keahi Loi o Kapau, alaila aku, Nema 28° Komohana 1 1/5 100 Kaulahaa, e pili ana i ka auwai o Kahalau, Akau 60° Kom. 2 5/100 Kaul. e pili ana inia Loi o Kapau, Nema 30° Komohana, h. Kaulahaa, e pili ana inia Loi o Kapau, Akau 28° Kom. 10 pautu, e pili ana inia Loi o Pookina, Akau 2° Nihina 25 pautu, e pili ana inia Loi o Pookina, Akau 74° Kom. 92° pautu e pili ana inia Loi o Pookina, Akau 5° Nihina, h. 1 1/100 Pautu, e pili ana inia Loi o Pookina me Kapali, Nema 65° Nihina 1 1/100 pautu, e pili ana inia Loi o Nahoa, Akau 10° Nihina 1 5/100 pautu e pili ana inia Loi o Nahoa, Akau 17° Nihina 54 pautu, e pili ana inia Loi o Nahoa, Akau 10° Nihina 30 pautu, e pili ana me ma Loi o Nahoa, Ak. 51; Nih. 80 pautu, e pili ana me ma Loi o Nahoa, Ak. 56; Nihina 50 pautu, e pili ana me ma Loi o Nahoa, Ak. 58; Nihina 66 pautu, e pili ana i ma Loi o Nahoa, Nema 35° Kom. 2 1/100 Pautu e pili ana inia Loi o Kapau, Nema 30; Nih. h. 8 1/100 pautu, e pili ana i ka auwai o Kapalau, Eili ana 1 Eka, —

Apana 2 Aina Kalo me Kula maloko ka ili o Kapalau Nihina Koloa Kona Kauai Penei ma Motuana, E hoomaka ana ma ka auwai, Kawailale ka inoa, ma ke Pihiki Nema, Nih. i ka aina o Paalawahia, Alaila aku, Kom. 19° Kom. 1 1/100 Kaul. e pili ana i ka aina o Paalawahia, Nema 30° Kom. 2 5/100 Kaul. e pili ana i ka auwai o Kapalau, Kom. 67° Nih. h. 1 1/100 Kaul. e pili ana inia Loi o Nihau, Kom. 30° Kom. 55 Pautu, e pili ana inia Loi o Nihau Kom. 68° Nih. 1 1/100 Kaul. e pili ana inia Loi o Nihau, Ak. 18° Kom. 3 5/100 Kaul. e pili ana inia Loi o Nihau, Ak. 46° Kom. 70 pautu, e pili ana me ma Loi o Nihau, Ak. 25° Nih. h. Kaul. e pili ana inia Loi o Nihau Ak. 65° Kom. 90 pautu, e pili ana i ka auwai, Eili ana 2 Puda, 26 Perka,

Apana 3, Aha Loi maloko ka ili o Nioca Mahaulupu Kona Kauai, Penei ma motuana, E hoomaka ana ma ke Pihiki Nema, Kom. o ma Loi o Nihiki, alaila aku, Kom. 30° Nih. 50 pautu e pili ana inia Loi o Paavao, Kom. 60° Nih. 5 Kaul. e pili ana inia Loi o Paavao, Ak. 26° Nih. 1 5/100 Kaul. e pili ana i ke Kula o Konohiki, Ak. 60° Kom. 3 Kaul. e pili ana inia Loi o Keahi, Ak. 20° Nih. 1 6/100 Kaul. e pili ana inia Loi o Keahi, Kom. 13° Kom. 95 pautu, e pili ana inia Loi o Kahu, Kom. 12° Kom. 32 pautu, e pili ana inia Loi o Isaia, Kom. 38° Kom. 1 2/100 pautu, e pili ana me ma Loi o Isaia, Eili ana 1 Eka 12 Perka,

Kauai, Sept 3, 1852
W. H. Pease

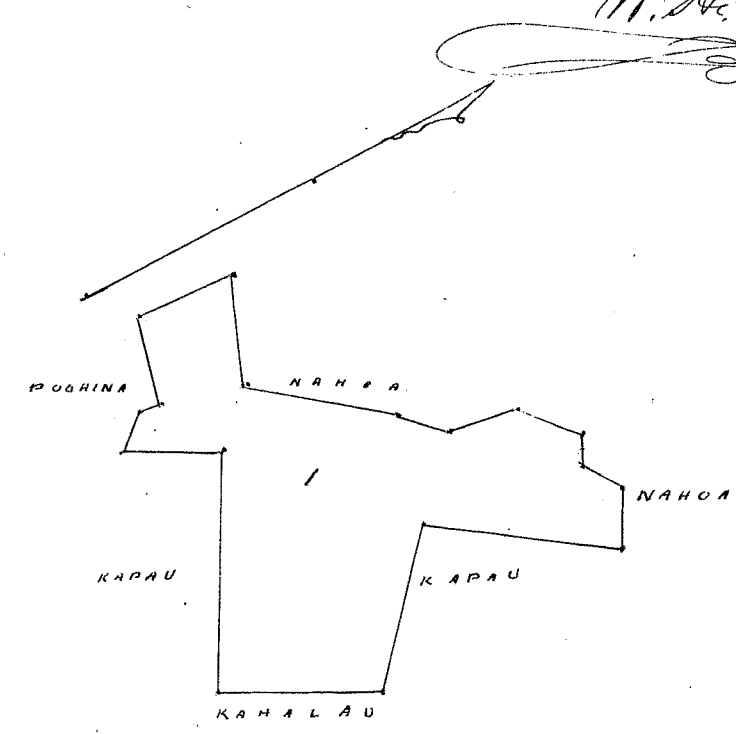
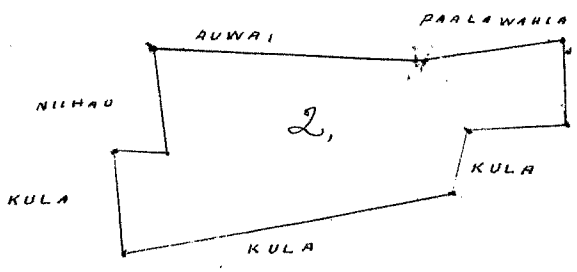
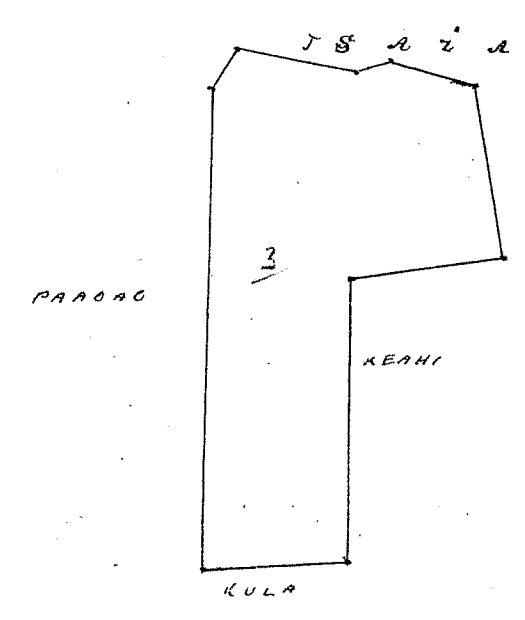

Uku Pau Loa 6.
W. H. Pease
G. M. Robertson
J. Kekaulahas
J. H. Smith

Honolulu, 5 Oct. 1852.

Kolu 5383. Hakuole ✓

Kipu, Kauai.

237

Aina Kala me Kula, maloko. ka ili o Kupae, Ahupuaa o Kipu, Puna Kauai, Penei ma Mokuna. E hoomaka ana ke Kahawai o Kulaia, ma ke Kapa Hema, ma Kahi laau Kala, alaila aku, Nem. 32° Kom. 1 Haul, e pili ana i ke Pula o Konoiki; Ak. 63° Kom. 6 5/10 Haul, e pili ana i ke Pula o Konoiki; Ak. 39° Niki. 2 5/10 Haul, e pili ana me ke Pula o Konoiki; Nem. 50° Niki. 6 2/10 Haul, e pili ana i ke Kahawai o Kulaia, e ili ana 1. Puka, 17 Puka,

Kauai, Sept. 3, 1852
W. H. Pease.

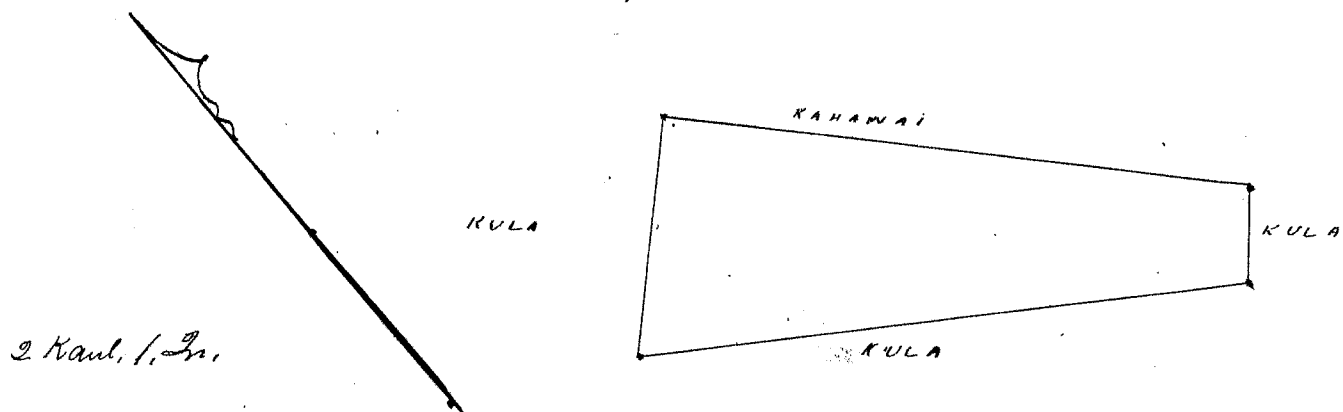

Wai paau loa # 5

W. H. Pease
G. M. Robertson
J. Kakaualaa
J. H. Smith

Honolulu Oct 5, 1852

Kolu 5481 Upai ✓

Kaiku, Kauai

Aina Kala me ke Pula, maloko. ka ili o Waiaupua, Ahupuaa o Kipu, Puna Kauai, Penei ma Mokuna. E hoomaka ana ke Kapa o ke Kahawai o Kulaia, Akau ma Kahi pohaku, alaila aku, Akau. 55° Komohana 3 6/10 Haul, e pili ana i ke Pula o Konoiki; Hema 45° Kom. 5 1/10 Haul, e pili ana i ke Pula o Konoiki; Hema 45° Niki. 4 2/10 Haul, e pili ana i ke Pula o Konoiki; Akau. 15° Niki. 1 3/10 Haul, e pili ana i ke Kahawai o Kulaia, E ili ana 1 Puka 16 Puka,

Kauai, Sept. 3, 1852
W. H. Pease.

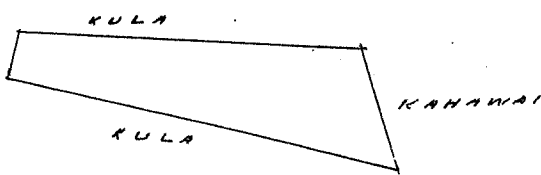

Wai paau loa # 4

W. H. Pease
G. M. Robertson
J. Kakaualaa
J. H. Smith

Honolulu 5 Oct 1852

Kolu 3655 Koanealuaakine ✓

Naviliwili, Kauai

E kolu Li, maloko. ka ili o Kaleihao, Ahupuaa o Naviliwili, Puna Kauai, Penei ma Mokuna. E hoomaka ana ma Kahi auwai, ma ke Kahi Hema, Kom. o ma Li. Pohana, alaila aku, Akau. 66° Niki. 1 Haul, e pili ana ina Li. Pohana, Ak. 10° Kom. 3 8/10 Haul, e pili ana ina Li o Konoiki; Nem. 75° Kom. 2 1/10 Haul, e pili ana i ke Kahawai; Nem. 3° Niki. 2 Haul, e pili ana i ka aina o Konoiki; Nem. 38° Niki. 1 5/10 Ak. e pili ana ina Li o Kalala, Nem. 60° Niki. 90 puka, e pili ana i ke Pula o Konoiki; E ili ana 3 Puka 7 Puka

Kauai Sept 3, 1852
W. H. Pease.

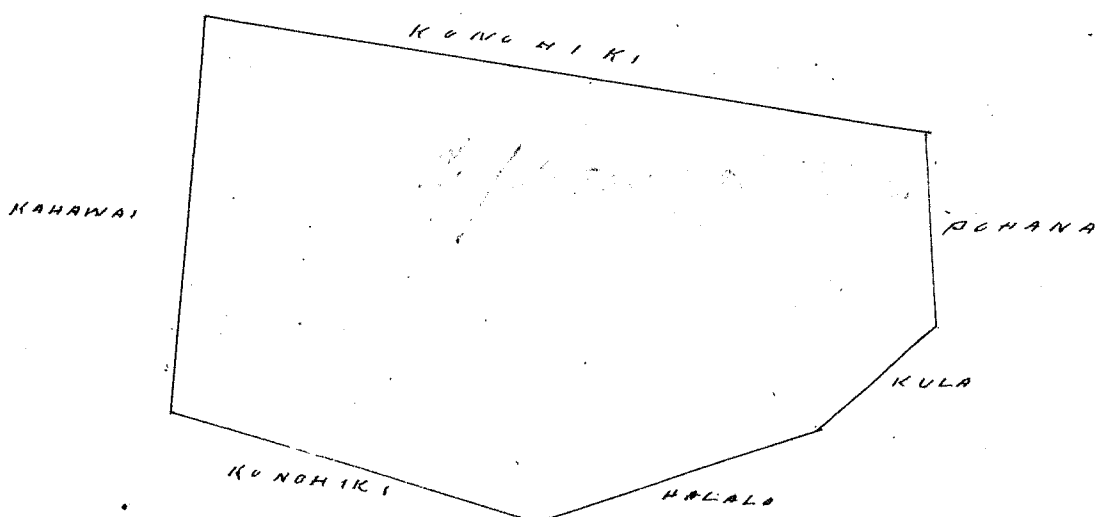

1 Haul, 1 1/2

Uku Pau Loa # 5

W. H. Pease
G. M. Robertson

S. Hekaulaha
J. H. Smith

Honolulu 5 Oct 1852

Kelu 3314 Makalalau

Niimalu Puna Hawaii

Apana 1. Pahale, maloko, ka Ili, Palipaliaki, Ahupuaa, Niimalu Puna Hawaii, Penei na Mokuna. Choomaka ana ma ke Pihii, Ak. 35, ka pahale, Au, alaila aku, Kom. 30, Hiki, 1/100 Kaul. e pili ana i ka pahale, Au, Ak. 60, Hiki, 1/600 Kaul. e pili ana i ke Pahi, i Akau, 30, Kom. 1/100 Kaul. e pili ana i ke Kula. Konohiki, Hem. 60, Kom. 1/100 Kaul. e pili ana, i ke Kula. Konohiki, e ili ana 1 Ruda.

Apana 2, Aina Kala ¹⁰¹ me Kula, maloko, ka Ili o Koluia Choomaka ana ka pali ma Kahi pahu laau, Kom. 15, Hiki 3/100 Kaul. e pili ana ina Ili. Konohiki, Ak. 78, Hiki, 1/100 Kaul. e pili ana ina Ili. Konohiki, Ak. 10, Hiki, 2 Kaul. e pili ana ina Ili o Makahiki, Ak. 73, Kom. 3/100, e pili ana i ka pali, Kom. 72, Kom. 2 Kaul. e pili ana i ka pali, Eili ana 1 Eka, 1 Ruda, 30 Perka.

Hawaii, Sept. 3, 1852

W. H. Pease

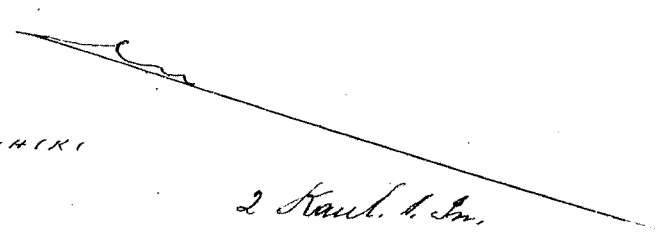
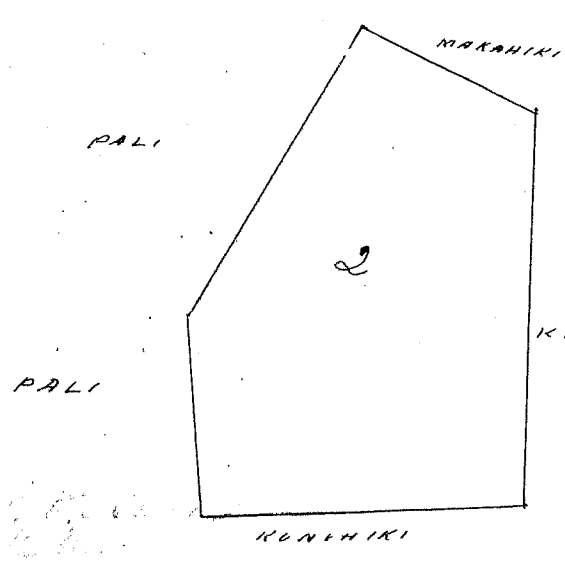
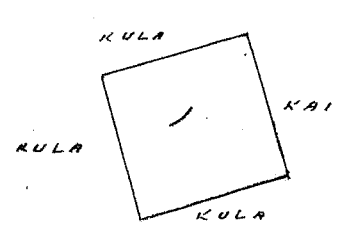

3 Identical successive
C. Guards

Nawa Aarao 525
" " 491 R4

Uku Pau Loa # 5

W. H. Pease
G. M. Robertson

S. Hekaulaha
J. H. Smith

Honolulu 5 Oct 1852

Kelu 3605 Kaiahomoku

Niimalu Hawaii

Maloko, ka Ili o Kakuha, Niimalu Puna Hawaii, Apana 1. Pahale, Choomaka ana ma ke Pihii Kema, Kom. ka pahale, Koa, Ak. 35, Kom. 1/100 Kaul. e pili ana i ka pahale, Koa, Kom. 62, Kom. 1/100 Kaul. e pili ana i ke Kula. Konohiki, Hem. 35, Hiki, 1/100 Kaul. e pili ana i ke Kula. Konohiki, Ak. 62, Hiki 1/100 Kaul. e pili ana i ka pahale, Kapau, Eili ana 32 Perka.

Apana 2, Aina Kala me ke Kula maloko, ka Ili o Kakuha, Penei na Mokuna, Choomaka ana Kahi laau Kala, ma ka loko. Maloko, ka inna, alaila aku, Ak. 80, Kom. 6/100 Kaul. e pili ana i ke Kula me Pali, Kom. 10, Kom. 50 prantia, e pili ana i ke Kula me ka pali, Kom. 65, Hiki 1/100 Kaul. e pili ana i ke Kula me ka pali, Kom. 80, Hiki, 2/100 Kaul. e pili ana i ke Kula me ka pali, Ak. 8, Kom. 1/100 Kaul. e pili ana i ka loko, Maloko, Ke Eili ana 3 Ruda, 15 Perka.

Hawaii, Sept. 3, 1852

W. H. Pease

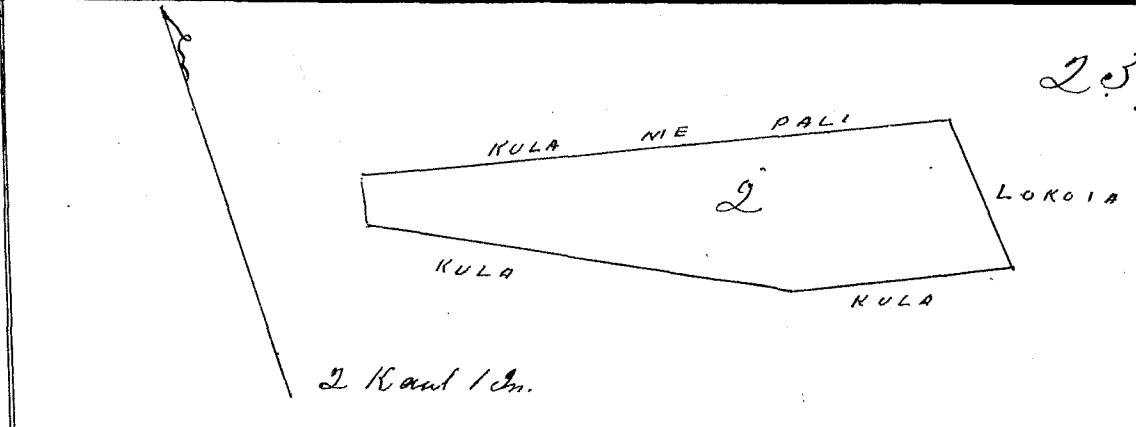
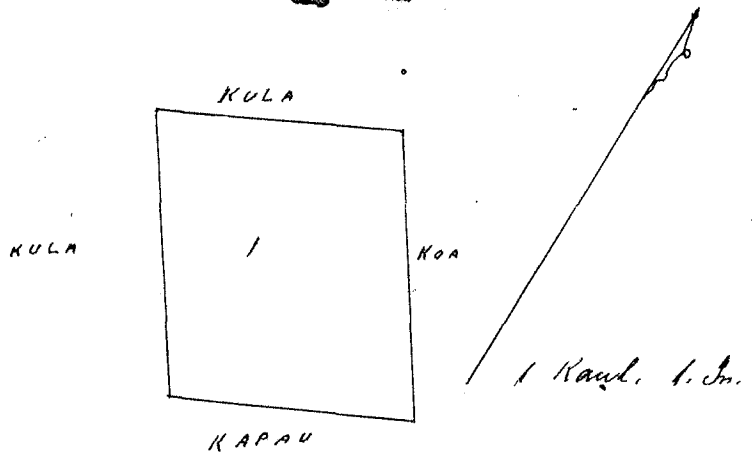

Wm Pau Ia \$5

W. H. Hui
G. M. Robertson
J. Kekaulahao
J. H. Smith

Honolulu 5 Oct 1852

Hulu 9010 Kahaawilau Niimatu, Hawaii

Apawa 1. aina kato, maloto o ka ili, Kahaawilau, Ahupuaa o Niimatu, Puna, Hawaii, Penei na onokuna, E hoomaka ana ona ke Kula, ona ke Kapa Ak. Kom. o na Loo Puhale, Nema 2⁶/₁₀₀ Kaul. e pili ana ina Loo Puhale, Nem. 83. Kom. 2 Kaul. e pili ana i ke Kula o Konoohiki, Ak. 60. Kom. 2. 4⁶/₁₀₀ Kaul. e pili ana i ke Kula o Konoohiki, Ak. 15. Kom. 4¹⁰/₁₀₀ Kaul. e pili ana me na Loo Hailau, Ak. 84. Nih 2 Kaul. e pili ana i ke Kula o Konoohiki; Nema 9. Nih 2⁹⁵/₁₀₀ Kaul. e pili ana i ke Kula o Konoohiki, Ak. 89. Nih 1³⁰/₁₀₀ Kaul. e pili ana i ke Kula Konoohiki; Eili ana 1 Eka, 1 Ruda, 16. Perka.

Apawa 2. Pahale maloto o ka ili o Faiaa, Penei na onokuna, E hoomaka ana ona Kahi kaam Kulu; alaila akai, Nem 4. Nih. 1⁶/₁₀₀ Kaul. e pili ana i ke Kula, Nem. 86. Kom. 1⁶/₁₀₀ Kaul. e pili ana me ke Kula, Ak. 4. Kom. 1⁶/₁₀₀ Kaul. e pili ana me ke Kula, Ak. 86. Nih. 1⁶/₁₀₀ Kaul. e pili ana i ke Kula. Eili ana 1 Ruda, Hawaii Sept. 3 1852.

W. H. Pease

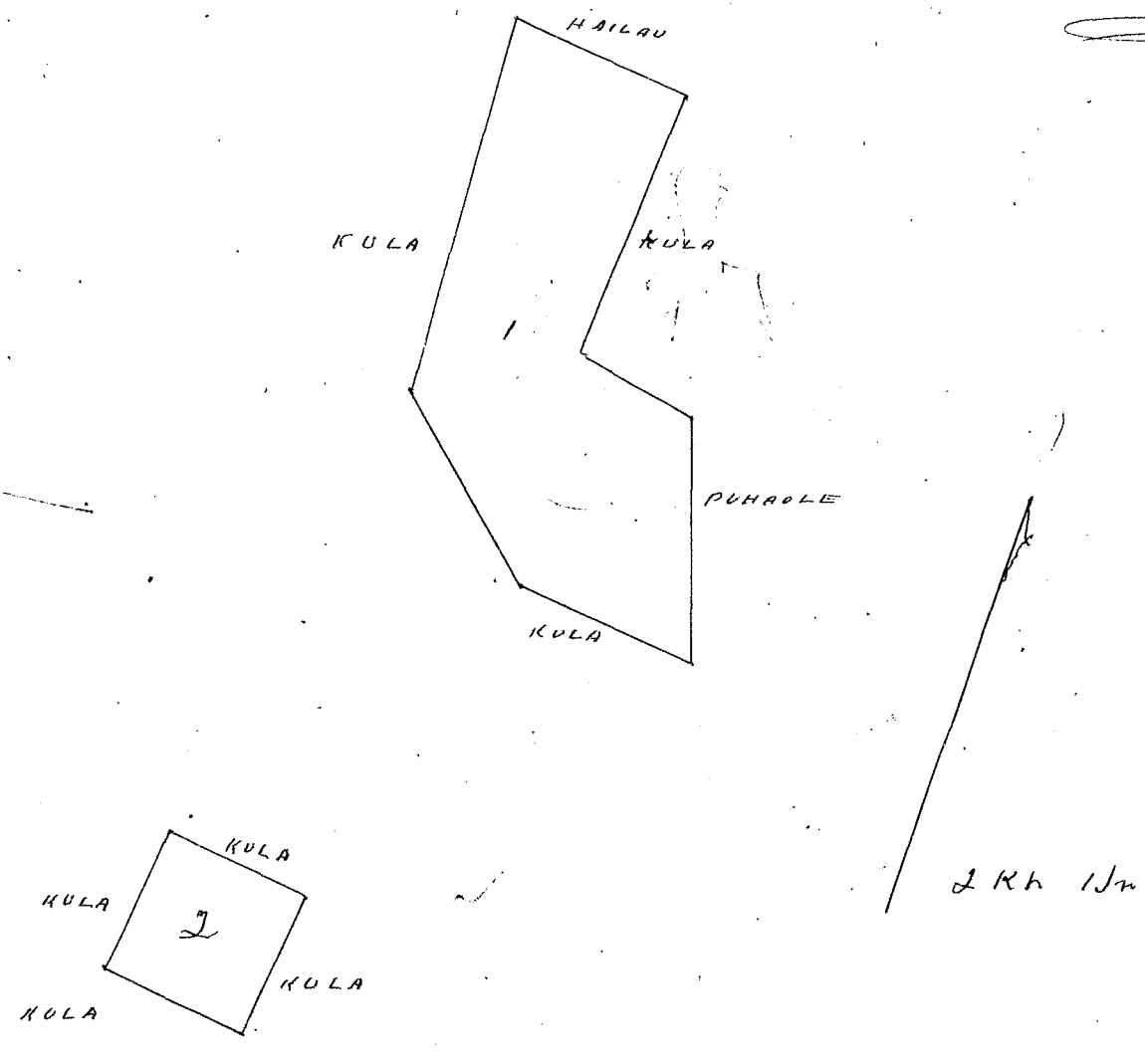

Wm Pau Ia \$5

W. H. Hui
G. M. Robertson
J. Kekaulahao
J. H. Smith

Honolulu, 5 Oct. 1852.

Aina kato, me Kula, me Pahale, maloko, ka Ihi. Maunua, Ahupuaa o Kawiliwili Puna Hawaii, Penei oia Mokuna. E hoomaka ma ka pahi me Kula, ma kahi pahu laau, aiaia aku. Ak. 47° Hik. 2 Haul. e pili ana i ka pahi me Kula, Kom. 85° Hik. 1 Haul. e pili ana i ka pahi me Kula, Ak. 49° Hik. 3 ⁵⁰/₁₀₀ Haul. e pili ana i ke Kula, Kom. 45° Hik. 5 ⁷⁰/₁₀₀ Haul. e pili ana i ke Kula, Kom. 20° Kom. 6 Haul. e pili ana i ke Kula, Kom. 47° Kom. 2 Haul. e pili ana i ke Kula, Ak. 30° Kom. 9 ²⁰/₁₀₀ Haul. e pili ana i ke Kula. e ihi ana, Eima, Eka.

Hawaii, Sept 3, 1852
 W. H. Pease,

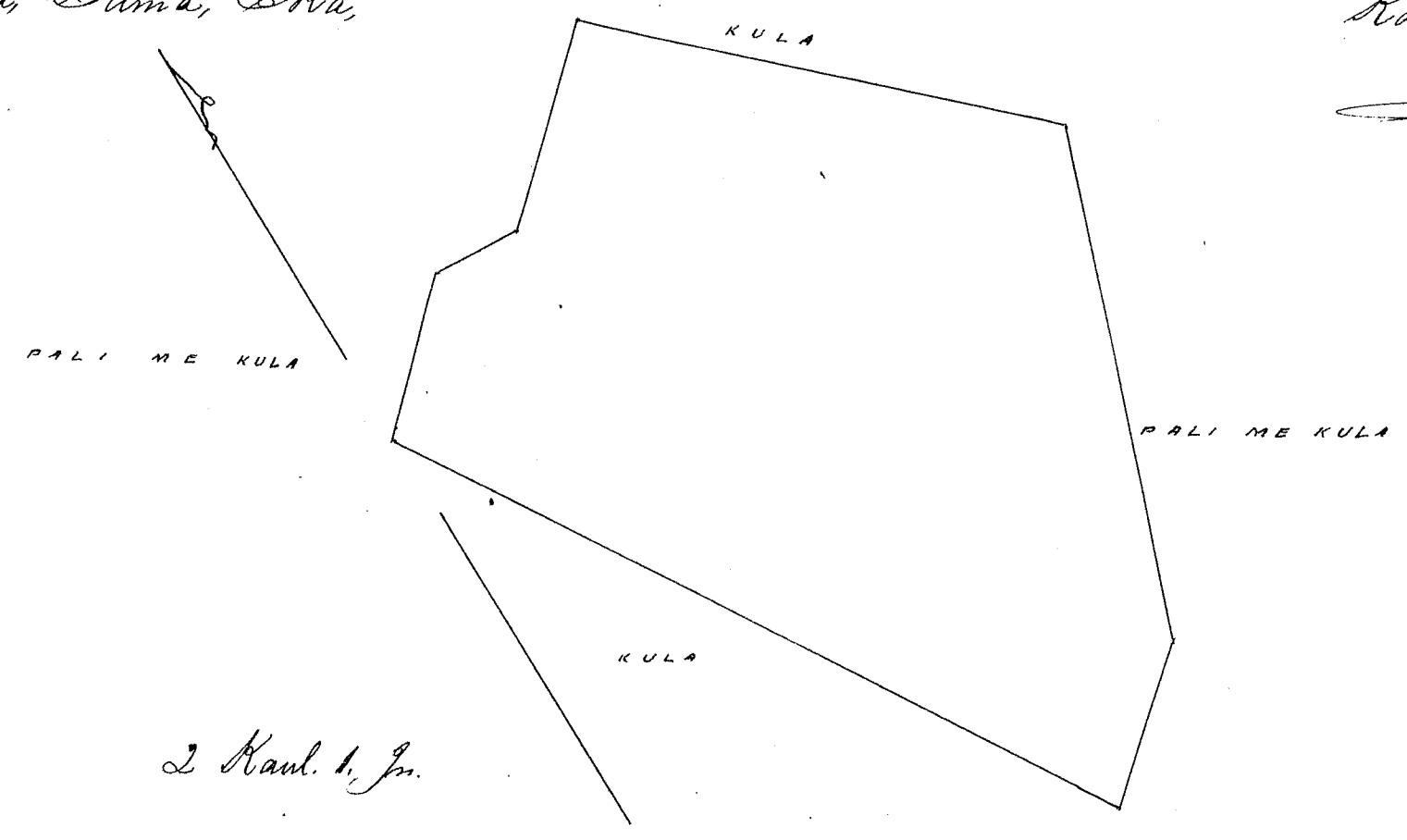

Uka Pau Lon 8

W. L. Lee
 G. M. Robertson
 J. H. Smith
 J. Kekaulahao

Honolulu 5 Oct 1852

Maloko o ke Ahupuaa o Kawiliwili Puna Hawaii.

Apawa 1. Pahale, maloko o ka Ihi o Papalina, Penei oia mokuna. E hoomaka ana ma ke kai, ma ke kahi kama, Hik. o ka Pahale o Katala; aiaia aku, Ak. 55° Kom. 2 Haul. e pili ana i ka pahale o Katala; Kom. 27° Kom. 1. ²⁵/₁₀₀ Haul. e pili ana i ke Kula o Konoehiki; Kom. 55° Hik. 2 Haul. e pili ana i ke Kula o Konoehiki; Ak. 27° Hik. 1 ²⁵/₁₀₀ Haul. e pili ana i ke kai, e ihi ana 1 Ruda.

Apawa 2. Ewa Loi. E hoomaka ma ke kahi Kom. Kom. o oia Loi o Kama, aiaia aku, Ak. 78° Hik. 2 ⁵⁰/₁₀₀ Haul. e pili ana ina Loi o Kama, Kom. 15° Hik. 2 ²⁵/₁₀₀ Haul. e pili ana ina Loi o Waikahu, Ak. 85° Kom. 3 Haul. e pili ana i ke Kula, Ak. 4° Kom. 1. ²⁰/₁₀₀ Haul. e pili ana ina Loi o Kikala, E ihi ana 2 Ruda.

Apawa 3. Aina Kato. E hoomaka ana ma ka pahi me auwai, ma ke kahi kama Kom. o oia Loi o Kikala, aiaia aku, Ak. 66° Kom. 3 ¹⁰⁰/₁₀₀ Haul. e pili ana ina Loi o Kikala aiaia aku, Kom. 75° Kom. 2 ⁵⁰/₁₀₀ Haul. e pili ana ina Loi o Waikahu, Kom. 2° Kom. 4 ²⁵/₁₀₀ Haul. e pili ana i ke Kula, Kom. 28° Hik. 1 ²⁰/₁₀₀ Haul. e pili ana ina Loi o Kelihanani; Ak. 46° Hik. 6 ⁹⁰/₁₀₀ Haul. e pili ana i ka pahi. E ihi ana 1 Eka, 1 Ruda, 30 Perka.

Hawaii Sept 3, 1852

W. H. Pease

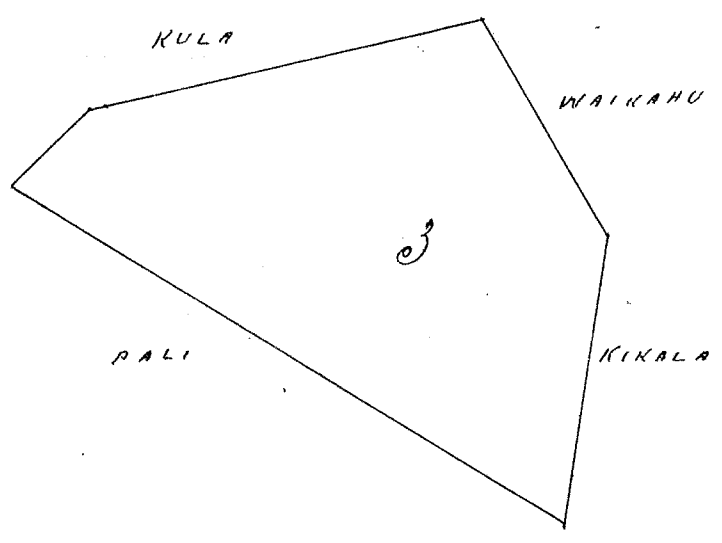

2 Kaul. 1 In.

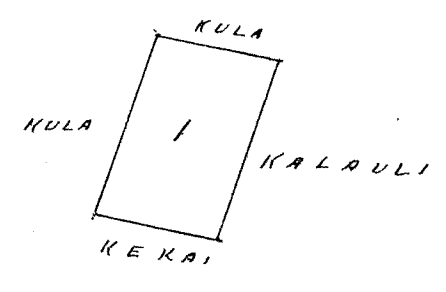
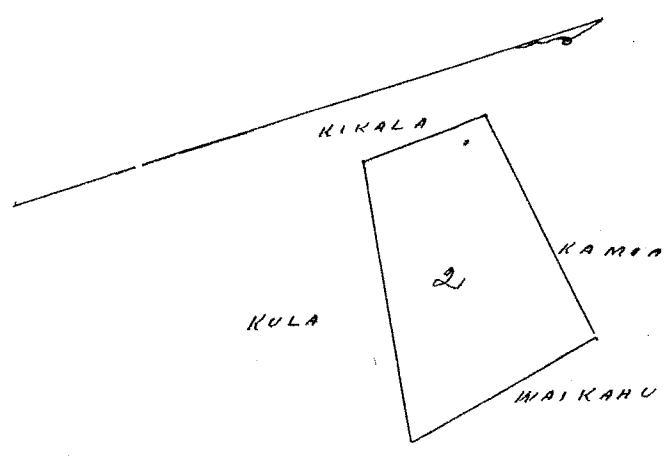

Wm Pau Lou # 6
 W. Lee
 G. M. Robertson
 J. Kekaulahao
 J. H. Smith

Honolulu 5 Oct 1852.

Wells 3248 Hoanalei

Nawiliwili Hawaii

Maloko, ke Ahupuaa, o Nawiliwili, Puna, Hawaii,
 Apuana 1. Aina Kalo, maloko o ka ili o Mwauka, Penei oia Mokuna, Choomaka ana ma
 ka hii lauan Han, alaila a Ku, Hem. 77, Kom. 1/2⁵ Kaul. e pili ana i ke Kula, Ak. 11, Kom. 1/2 Kaul. e pili ana i ke Kula
 me Pali; Ak. 50, Kom. 3⁴/₁₀₀ Kaul. e pili ana i ke Kula me Pali; Ak. 30, Hiki. 2⁵⁰/₁₀₀ Kaul. e pili ana i ke
 Kula me Pali; Hem. 53, Hiki 4¹/₁₀₀ Kaul. e pili ana i ke Kula me Pali; Hem. 5, Hiki. 5 Kaul. e pili ana i ke
 Kula me Pali; e ili ana i Eka. 2, Ruda.

Apuana 2. Aina Kalo me Kula, maloko o ka ili o Kaluahine, Choomaka ana ona hahi
 lauan Koa, ma ka pali; alaila, Ak. 80, Kom. 12 Kaul. e pili ana i ke Kula, Hem. 55, Kom. 1 Kaulahao,
 e pili ana i ke Kula me ka pali; Hem. 35, Hiki. 1²⁵/₁₀₀ Kaul. e pili ana i ke Kula me ka pali; Hem. 83, Hiki
 4⁶⁰/₁₀₀ Kaulahao, e pili ana i ke Kula, me Ii, Ak. 3, Kom. 3 Kaul. e pili ana i ke Kula me Ii,
 e ili ana i Eka, 2 Ruda, 20 Perka,

Hawaii, Sept 8, 1852
 W. A. Pease,

2 Kaul. 1 In.

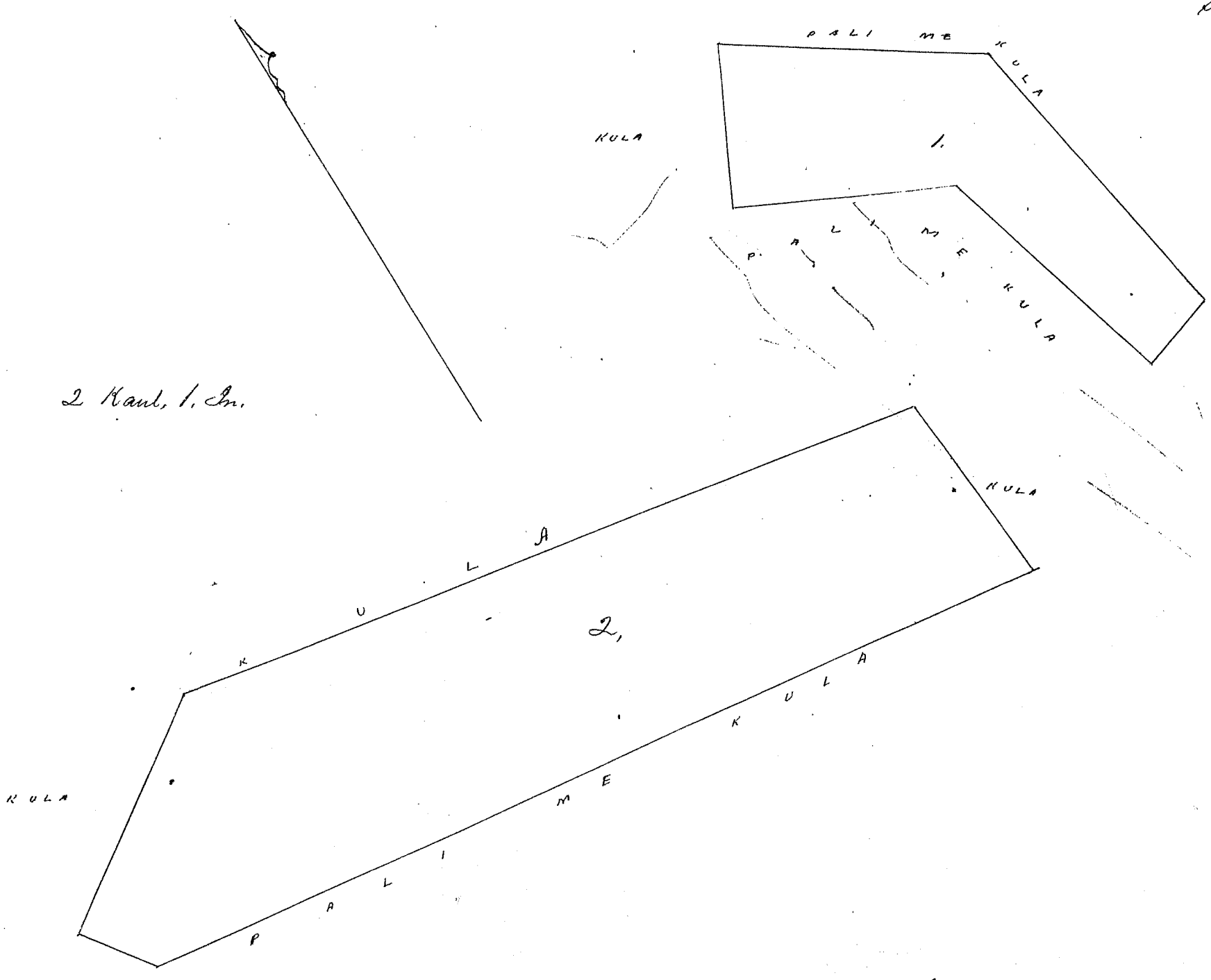

W. L. Lee
M. Smith
G. M. Robertson
J. Kikaulaha

Honolulu 5 Oct 1852

Uku 3907 Nakala

Kalapaki Kawai

Malalo o ke ahupuaa o Kalapaki Puna Kawai.

Apana 1. Pahale, me aha Loi; Puni ma motu. Chomaka ana ma ke kai, ma ke Kahawai o Konaawaike, alaila aku. Ak. 3; Kom. 1 Kaul. e pili ana i ke Kahawai o Konaawaike; Ak. 61; Kom. 1 25/100 Kaul. e pili ana i ke Kahawai o Konaawaike; Ak. 1; Kom. 2 3/100 Kaul. e pili ana ina Loi o Kauhailawa, Ak. 80; Kom. 1 1/100 Kaul. e pili ana ina Loi o Kauhailawa, Ak. 3; Kom. 2 Kaul. e pili ana ma Kauhailawa, Hem. 69; Hiki. 2 75/100 Kaul. e pili ana i ka pahi; Hem. 5; Kom. 1 Kaul. e pili ana ina Loi o Monohiki; Ak. 83; Kom. 90 pautu. e pili ana ma ka Pahale o Haa, Hem. 1; Kom. 1 Kaul. e pili ana ma ka pahale o Haa, Ak. 89; Kom. 60 pautu. e pili ana i ke kai, e ili ana 1 Eka, 2 Puda, 2 Perka.

Apana 2. Akahi Loi; Chomaka ana koke i ke Kahawai, ma ke Pahi Hem. Hiki, o kahi koke Malaila aku. Hem. 70; Kom. 1 9/100 Kaul. e pili ana i ke Koke, Hem. 23; Hiki. 2 40/100 Kaul. e pili ana ina Loi o Kikala, Ak. 55; Hiki. 2 Kaul. e pili ana ma Napolelei, Ak. 25; Kom. 1 9/100 Kaul. e pili ana ina Loi o Moki; e ili ana 1 Puda, 25 Perka.

Apana 3. Aina Kula; Chomaka ana ma kahi pahu laau ma ke Pula, alaila aku. Ak. 88; Hiki. 2 7/100 Kaul. e pili ana i ke Pula o Monohiki; Hem. 18; Hiki. 3 2/100 Kaul. e pili ana i ke Pula o Monohiki; Ak. 70; Hiki. 50 pautu. e pili ana i ke kai; Ak. 28; Kom. 6 Kaul. e pili ana i ke Pula, Hem. 38; Kom. 2 4/100 Kaul. e pili ana i ke Pula ma ka pahi; e ili ana 1 Eka, 20 Perka.

Kawai Sept 3, 1852

W. L. Pease

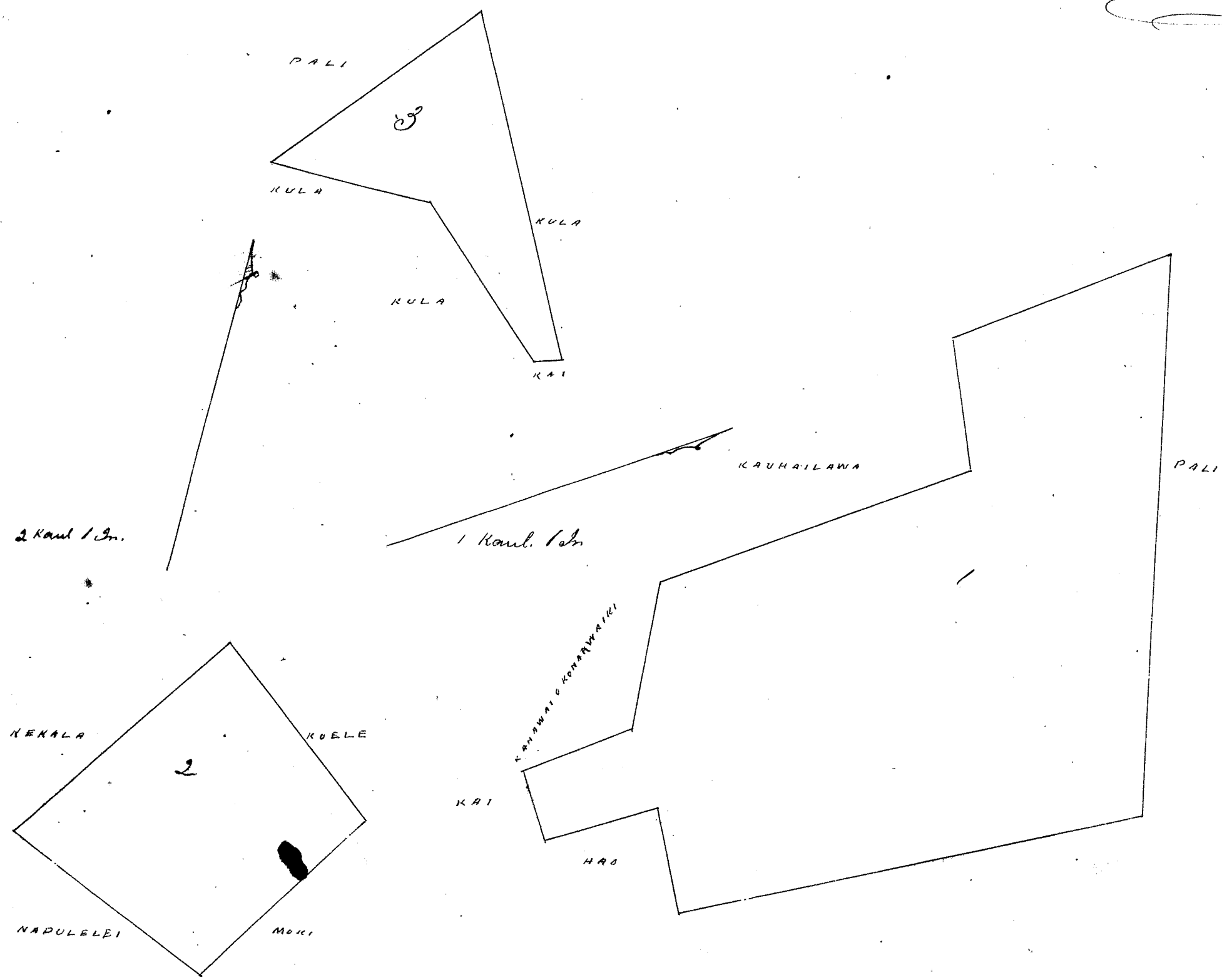

Uku Pau Loa \$ 6.

W. H. Bee
G. M. Robertson
J. Kikaulahao
J. H. Smith

Honolulu 5 Oct 1852.

Hulu 5109 Kuuike I

Maaloa, Hawaii

Aina Kala, Kula, me Pahala, Maloko, ka ili o Kaapuna, Ahupuaa, Mo'oa, Koolau, Hawaii,
E hoomaka ana ma ke Kapa Nihina, ke Kahawai, o Mo'oa ma Kahi laan ulu, alaila ahu, Ak. 75,
Nik. 3. ²⁰/₁₀₀ Haul, e pili ana i ke Kula o Konohiki, Ak. 23, Kom. 3 ⁴⁵/₁₀₀ Haul, e pili ana i ke Kula o
ke Kahawai, Ak. 60, Kom. 2 ⁵⁰/₁₀₀ Haul, e pili ana i ke Kahawai, Mo'oa, Kom. 10, Nik. 4 ⁵⁰/₁₀₀ Haul,
e pili ana me ke Kahawai o Mo'oa, e ili ana i Eka, 10 Perka

Hawaii Sept 3, 1852
W. H. Pease,
3

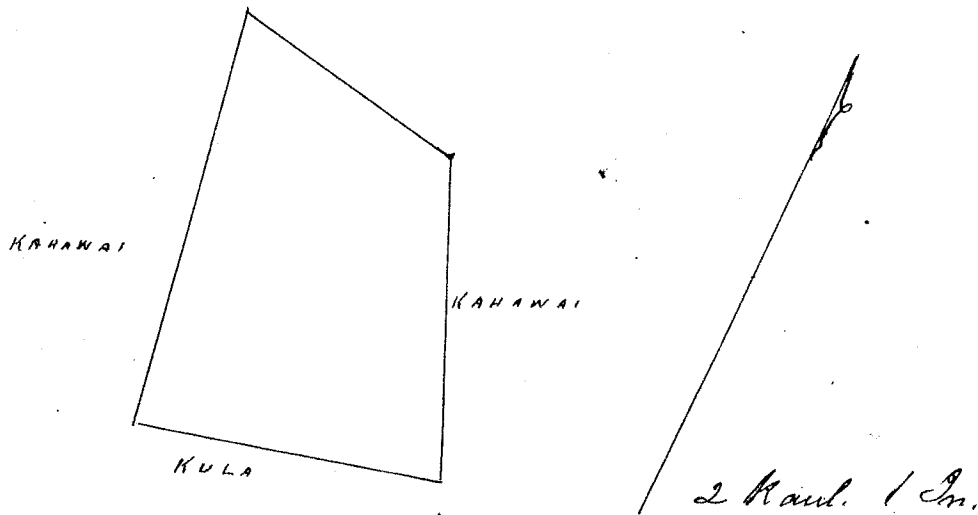

Uku Pau Loa \$ 5.

W. H. Bee
G. M. Robertson
J. Kikaulahao
J. H. Smith

Honolulu 5 Oct 1852.

Hulu 9799 Konohia I

Maaloa, Hawaii

Aina Kala, me Pahala, maloko o ke Ahupuaa, Mo'oa, Koolau Hawaii Puni ma mokuna,
E hoomaka ana ma ke Kapa Nihina, ke Kahawai, Mo'oa, ma Kahi pohaku, alaila ahu,
Ak. 85, Nik. 1. ⁶⁰/₁₀₀ Haul, e pili ana i ke Kula, Konohiki, Kom. 32, Kom. 3 ²⁰/₁₀₀ Haul, e pili ana i ke
Kula o Konohiki, Ak. 50, Kom. 1. ²⁰/₁₀₀ Haul, e pili ana i ke Kula o Konohiki, Ak. 30, Nik. 2 Haul,
e pili ana i ke Kahawai o Kula, e ili ana i Kula, 11 Perka.

Hawaii, Sept. 3, 1852
W. H. Pease,
3

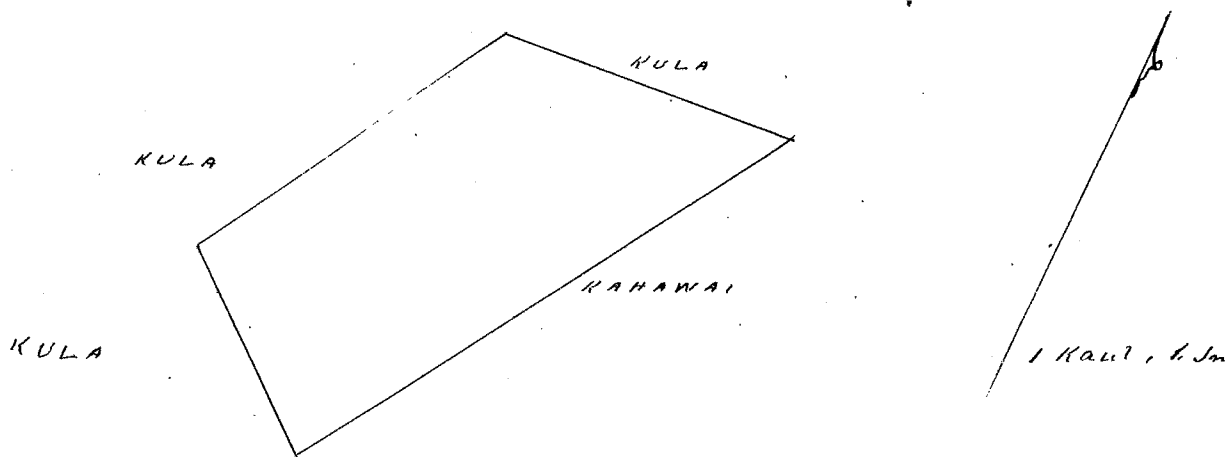

Uku Pau Loa \$ 4.

W. H. Bee
G. M. Robertson
J. Kikaulahao
J. H. Smith

Honolulu 5 Oct 1852.

Kulu 1761 Kawaihae - 37 1/2 Palolo Oahu.

Apana 1. E lua Ii i loko o Puakea, Hekeia, Palolo Oahu.
E hoomaka ma ke Pihikiki, e huli ana, Hem. 23° Kom i 1.42 Kh. ma ka palena o Paalea, Malaila aku, Hem. 23° Kom i 20 Kh. ma ko Paalea, Malaila aku, Ak. 34° Nih i 1.50 Kh. Malaila aku, Hem. 66° Nih i 1.10 Kh. ma ko Upepe palena a hiki i ka hoomaka ana, 1 5/100 Kh. huinaha

Apana 2, He Ii i loko o Puakea, Hekeia Palolo
E hoomaka ma ke Pihikiki Komohana, e huli ana, Ak. 20° Nih i 0.70 Kh. ma ka palena o Paalea Malaila aku, Hem. 68° Nih i 0.82 Kh. ma ko Paalea, Malaila aku, Hem. 16° Kom i 9.70 Kh. Malaila aku, Ak. 19° Kom i 0.82 Kh. ma ke Kooke, a hiki i ka hoomaka ana, He. 57/100 Kh. Pau loa 2 5/100 Kh. huinaha

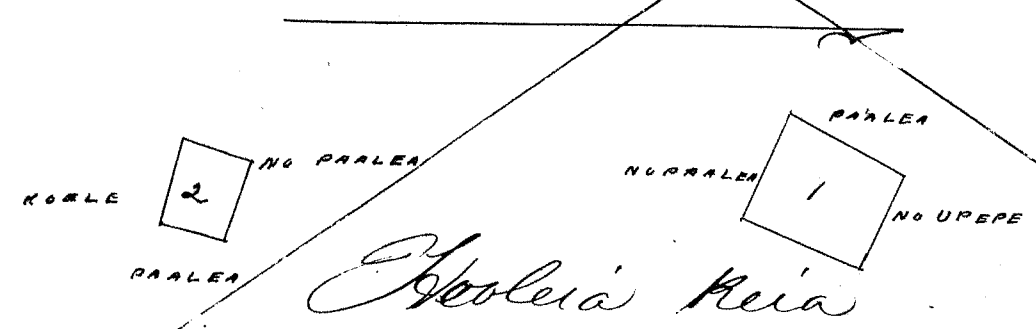

A. Bishop
Mea ana.

See Page 387

Ulu Pau Loa # 4
N. Kulu

G. M. Robertson
J. H. Smith
J. Kaka'aula'au

Honolulu 8 Oct 1852

Kulu 5811 Koumumu Kuanui Aroilina Waipio Ewa Oahu.

Apana 1. Ka mo'oina, Honohono, Ii o Hanalea, Waipio, Ewa, Oahu.
E hoomaka ma ke Pihikiki o ka mo'oina, e pili ana me Waikeli, ma ka aoao Komohana, a e huli ana, Hem. 28 1/2° Nih i 2.00 Kh. ma ka palena o Waikeli, Malaila aku, Hem. 23° Nih. 2.80 Kh. ma Waikeli, Malaila aku, Ak. 54° Nih i 3.40 Kh. ma ka palena o Komohana, Malaila aku, Ak. 22 1/2° Kom i 1.20 Kh. ma ko Komohana, Malaila aku, Ak. 69° Nih i 1.75 Kh. Malaila aku, Ak. 32° Kom i 1.90 Kh. ma ko Komohana, Malaila aku, Ak. 16° Nih i 0.70 Kh. Malaila aku, Ak. 37° Nih i 0.55 Kh. Malaila aku, Hem. 68 1/2° Nih i 0.75 Kh. ma ko Komohana, Malaila aku, Ak. 31 1/2° Kom i 1.00 Kh. ma ka palena o Ii, Malaila aku, Ak. 44° Kom i 3.00 Kh. ma ko Ope, Malaila aku, Hem. 47° Kom i 0.42 Kh. ma ko Kauhaliu, Malaila aku, Hem. 46° Nih i 0.84 Kh. ma ko Kauhaliu, Malaila aku, Hem. 28° Nih i 1.33 Kh. Malaila aku, Hem. 2 1/2° Kom i 0.88 Kh. Malaila aku, Hem. 71° Kom i 1.65 Kh. ma ko Kauhaliu, Malaila aku, Ak. 66° Kom i 0.30 Kh. Malaila aku, Hem. 60° Kom i 0.70 Kh. Malaila aku, Ak. 36° Kom i 2.80 Kh. ma ko Kauhaliu, Malaila aku, Ak. 72° Kom i 1.40 Kh. ma ko Komohana, Malaila aku, Hem. 84° Kom i 1.05 Kh. Malaila aku, Hem. 8° Nih i 0.40 Kh. Malaila aku, Hem. 35° Nih i 3.63 Kh. ma Waikeli, Malaila aku, Hem. 42 1/2° Kom i 0.30 Kh. a hiki i ka hoomaka ana, He 3 55/100 ma Eka.

Apana 2, Ka mo'oina o Kauhaliu Ii o Hanalea, Waipio
E hoomaka ma ke Pihikiki Komohana, e huli ana, Ak. 63° Nih i 1.73 Kh. ma ke Kooke Malaila aku, Ak. 3° Kom i 1.00 Kh. Malaila aku, Ak. 61° Nih i 0.90 Kh. ma Kula o Komohana, Malaila aku, Hem. 33° Nih i 1.54 Kh. ma ko Komohana, Malaila aku, Hem. 59 1/2° i 0.45 Kh. Malaila aku, Hem. 18° Nih i 0.78 Kh. Malaila aku, Ak. 86 1/2° Nih i 0.60 Kh. Malaila aku, Hem. 22 1/2° Nih i 2.42 Kh. ma ko Komohana, Malaila aku, Hem. 75° Kom i 2.33 Kh. ma ko Lanu'he'au, Malaila aku, Ak. 26° Kom i 1.73 Kh. ma ko Napu'awa, Malaila aku la, Ak. 71° Kom i 0.76 Kh. Malaila aku,

At 29° Nym i 0.75 Kh. ma ke Honolulu; a hiki: ka humaka ana
ke 1/10 Oka, Pau loa. 4 65/100 ma Oka.

Oct. 1, 1852

A. Bishop
mea ana,

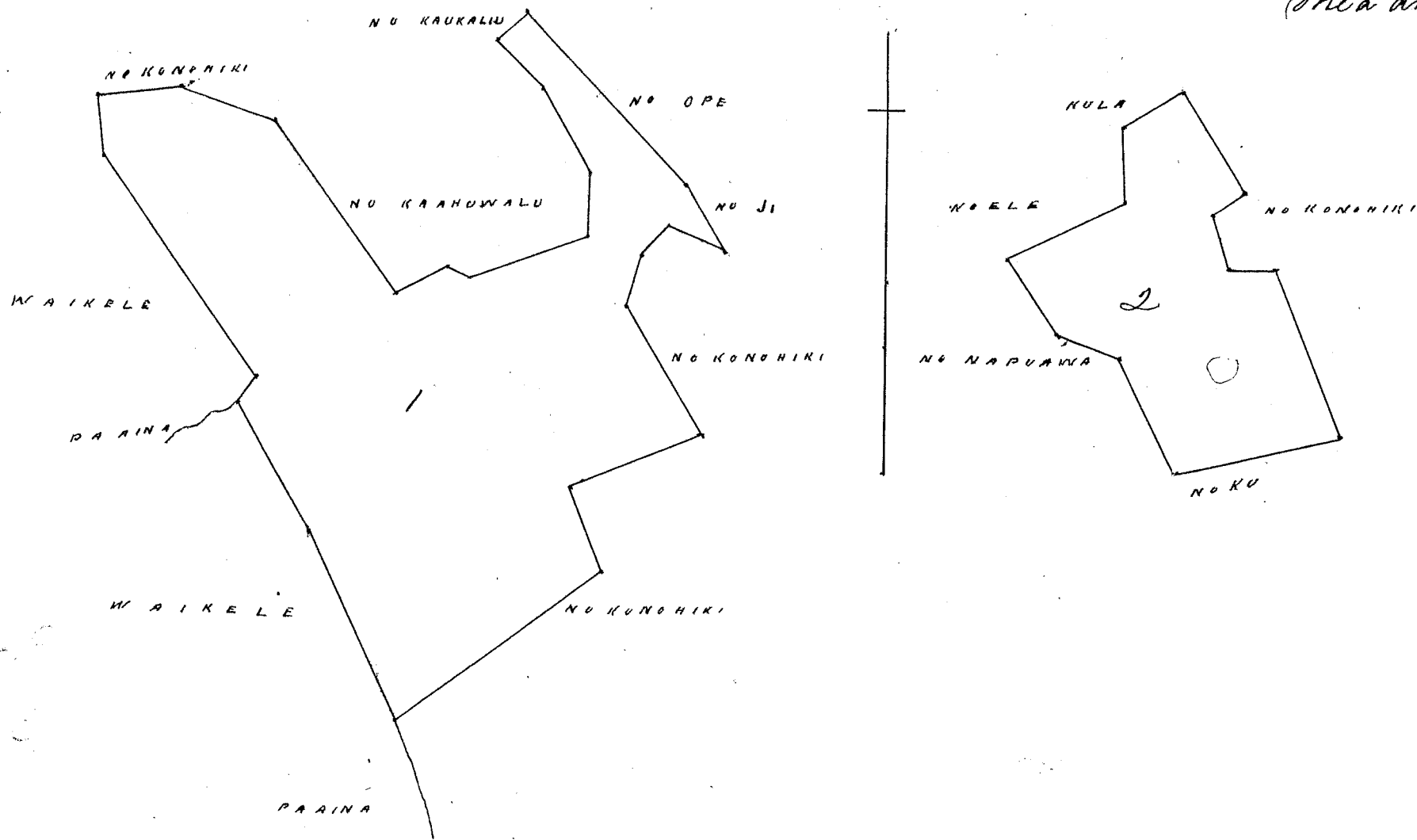

Uku Pau Loa # 6.

W. H. Pease

G. M. Robertson

J. Kekaulahas

J. H. Smith

Honolulu 9 Oct 1852

Uku 10014 Luahine

Lepuni Koolau Hawaii.

Aina Kala Kula me Pahale, maloko o ka ili o Kaunakakai ahipuaa o Lepuni Koolau
Hawaii; E humaka ma ke kai; ma ke Kapa At. Kom. ka pahale o Uwa, alaila aku,
Kem. 11° Kom. 1 7/100 Kaul. e pili ana i ka pahale o Uwa, At. 71° Kom. 50 pautu. e pili ana i ka
pahale o Uwa, Kem. 30° Kom 3 Kaul. e pili ana i ka pahale o Uwa, Kem. 20° Kom. 3 20/100 Kaul.
lahao, e pili ana i ke Kula o Uwa, At. 62° Kom 90 pautu, e pili ana i ke Kula me pali;
At. 19° Hiki 9 5/100 Kaul. e pili ana i ke Kula, me Pali Kem. 64° Hiki 1 75/100 Kaul. e pili ana i
ke Kai; me Pali; e ili ana o Kula, 25. Pika.

Hawaii, Sept. 2, 1852.

W. H. Pease,

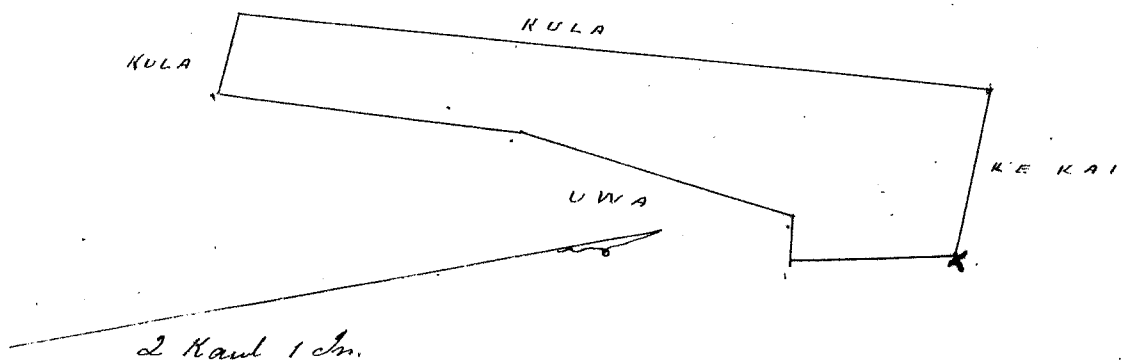

Uku Pau Loa # 3

W. H. Pease

G. M. Robertson

J. Kekaulahas

J. H. Smith

Honolulu, 5, Oct. 1852.

Kolu 9149 Kalarua

Lepuli Koolau Hawaii

Aina Kalo, Pahale me Kula, maloko o ke Ahupurua. Lepuli Koolau Hawaii, E hoomaka ana ma ke Kahawai o Maloaa, ma ke Kapa Komohana, ma kahi pohaku, abaila aku, Ak. 30. Kom. 1 70/100 Kaul. e pili ana i ke Kula o Konoohiki, Kom. 85. Kom. 6 Kaul. e pili ana i ke Kula o Konoohiki, Kom. 30. Nih 2 5/100 Kaul. e pili ana i ke Kula o Konoohiki Kom. 85. Nih 3 Kaul. e pili ana i ke Kahawai o Maloaa, Ak. 70. Nih 3 Kaul. e pili ana i ke Kahawai o Maloaa, e ili ana, 1 Eka, 25 Perka,

Hawaii Sept. 2, 1852
W. H. Pease,

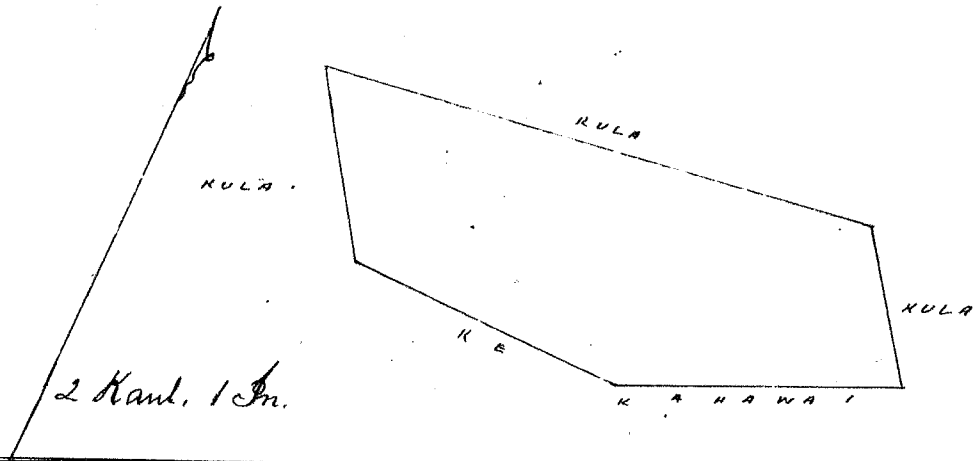

Uku Pau Loa # 5
W. H. Lee
G. M. Robertson
J. Kekaulahao
J. H. Smith

Honolulu 5 Oct. 1852

Kolu 10955 Mahineiki

Koolau Hawaii

Kalo, land, maloko o ka ili o Mahana, Hanalei Hanalei Hawaii, Penei ma mutuna, E hoomaka ana ma ke Kapa Akau, o ka wai o Mahana, ma ke Kahi Ak. Nih. o na Poi o Nunu, abaila aku Kom. 58. Nih. 4 Kaul. e pili ana ina Poi o Nunu, Ak. 24. Nih 5 Kaul. e pili ana i ke Kula, Ak. 51. Kom. 1 20/100 Kaul. e pili ana, i ke Kula, Ak. 23. Nih 2 Kaul. e pili ana i ke Kula, Ak. 74. Kom. 2 30/100 Kaul. e pili ana i kahi lii mahulehale, Kom. 28. Kom. 6 48/100 Kaul. e pili ana i ka wai o Mahana me Kula, e ili ana 2 Eka, 2 Kula 19 Perka,

Hawaii Sept 3, 1852
W. H. Pease,

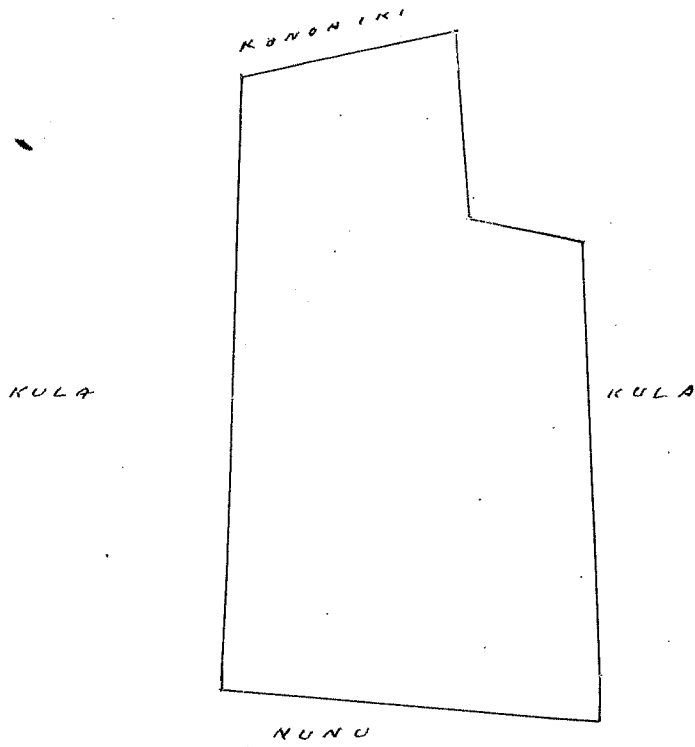

Uku Pau Loa # 6
W. L. Lee
G. M. Robertson
J. Kekaulahao
J. H. Smith

Honolulu, 5, Oct. 1852

Volume 10954 Waiahu + 45517

Hanalei, Kauai

247

Pahale, maloko o ka ili o Kawaiki, Hanalei, Haleia, Kawai, Penei ma Motuana, E hoomaka ana ma kahi laau Hanu, ma kahi pa, ma ke Pihia Ak. Kom. o Kua aina alaila aku. Nym. 30° N. K. 1 Kaul. e pili ana i ke Pula o Konohiki; Kom. 80° N. K. 150/100 Kaul. e pili ana i ke Pula o Konohiki; Ak. 11° N. K. 65 paupau, e pili ana i ke Pula o Konohiki; Ak. 20° Kom. 150/100 Kaul. e pili ana i ke Pula o Konohiki; Kom. 61° Kom. 150/100 Kaul. e pili ana i ka pa Hanu, e ili ana i Puda.

Kauai Sept. 2, 1852
W. H. Pease.

(Signature)

Ololoakaka. O ke ana ana a W. H. Pease, wa hoolia. i mana maka aao 455. 87. Buke Hookoo ka la 5. Oct 1852. oia ka i hookoo. maloko oia Buke C. Kamais. Amicari 5. 1853. Meakakau. L.H.K.A.

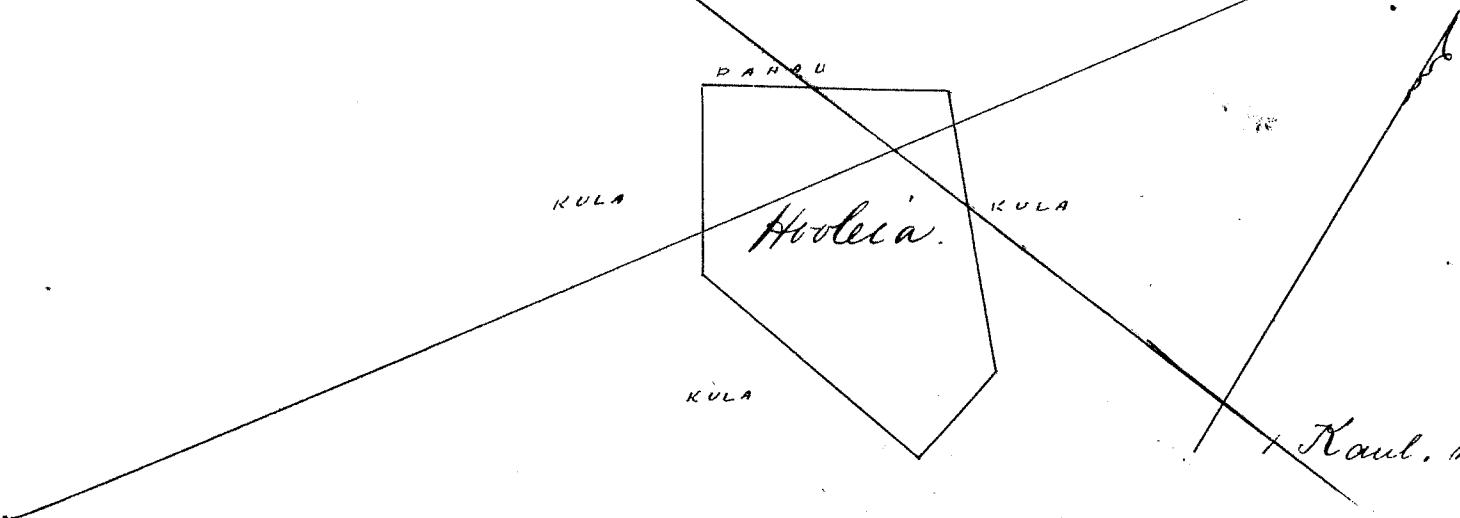

Uku Pau Lap 4.

W. H. Pease
G. M. Robertson
J. Hekaulaha
J. H. Smith

Honolulu, 5. Oct. 1852.

Volume 4076 Kamakaiwa (45407)

Hanalei, Haleia, Kauai

Apana 1. Akahi Loi, maloko o ka ili o Mahana, Ahupuaa o Hanalei, Haleia, Kawai, Penei ma Motuana. E hoomaka ana ma kahi Loi o Kaiwi, alaila aku. Ak. 32° Kom. 175/100 Kaul. e pili ana ina Loi o Kaiwi; Ak. 56° N. K. 135/100 Kaul. e pili ana ina Loi o Kaiwi; Kom. 32° N. K. 175/100 Kaul. e pili ana ma ke Pula, Kom. 56° Kom. 135/100 Kaul. e pili ana i ke Pula, e ili ana i Puda.

Apana 2. Pahale maloko o ka ili o Kawa, Penei ma Motuana. E hoomaka ana ma ke Pihia Ak. Kom. o ke pahale o Apolo, alaila, Ak. 26° Kom. 235/100 Kaul. e pili ana i ka Loko ia o Kawa, Ak. 32° N. K. 235/100 Kaul. e pili ana i ke Pula o Konohiki; Kom. 20° N. K. 20/100 Kaul. e pili ana i ke Kahawai o Waiula, Kom. 87° Kom. 165/100 Kaul. e pili ana i ka pahale o Apolo. e ili ana 2 Puda, 13 Perka.

Kauai Sept 31 1852
W. H. Pease.

(Signature)

See Page 454 Vol. 7.

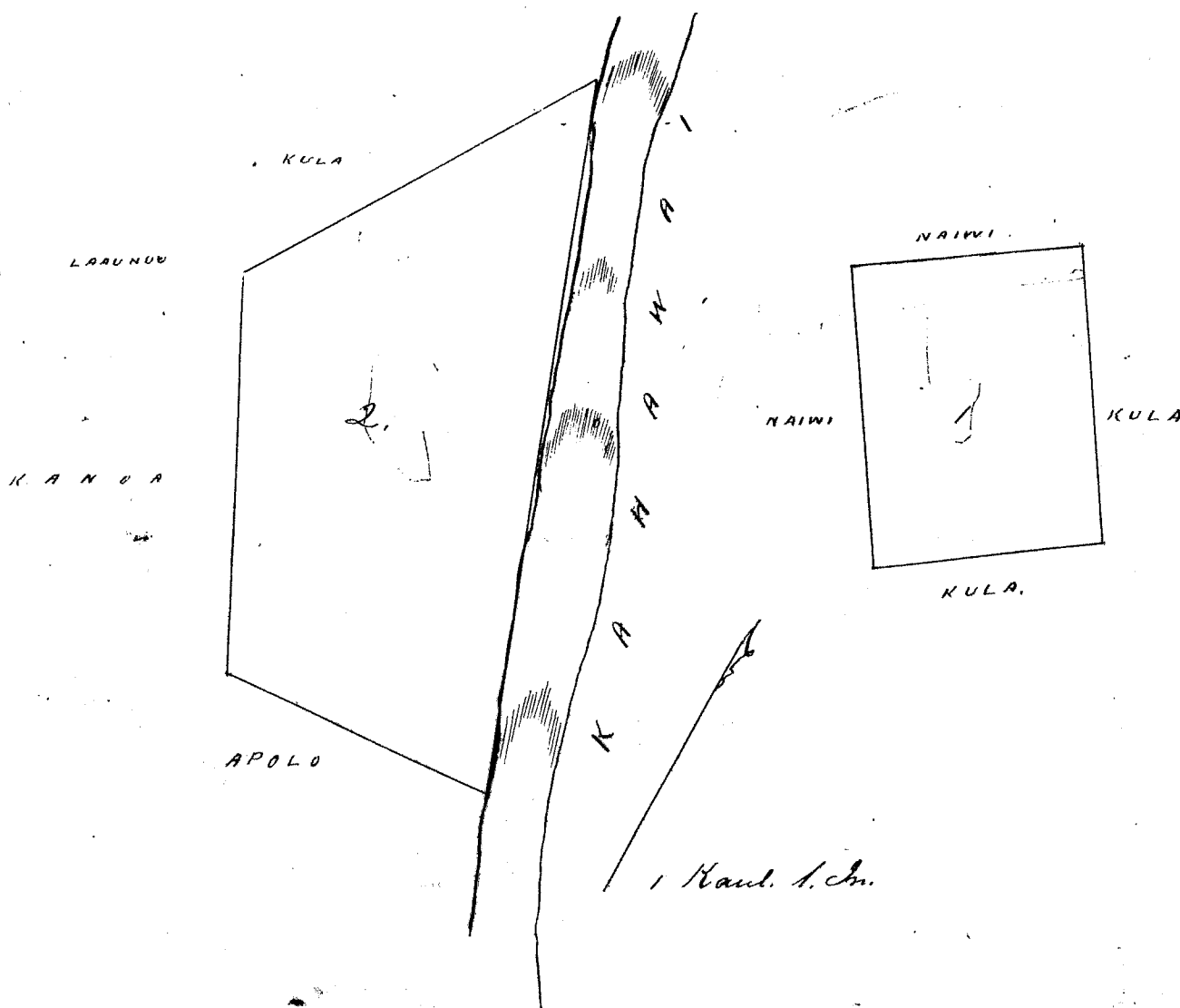

Wku Pau Loa \$5.
W. H. Lee
G. M. Robertson
J. Kekaulahao
J. H. Smith

Honolulu 5 Oct. 1852.

Kolu 4080 Kauhilina

Hanalei, Hawaii

Maloko o ke Ahupuaa o Hanalei, Halelika Hawaii.

Apana 1. Pahale. E hoimaka ana ma ke Kula ma kahi pahu laau, alaila aku, Hem. 11. Kom. 1⁸²/₁₀₀ Kaul. e pili ana i ke Kula o Konohiki; Hem. 89. Hik. 1⁴⁰/₁₀₀ Kaul. e pili ana i ke Kula o Konohiki; Ak. 11. Hik. 1⁸²/₁₀₀ Kaul. e pili ana i ke Kula o Konohiki; Ak. 89. Kom. 1⁴⁰/₁₀₀ Kaul. e pili ana i ke Kula o Konohiki; e ili ana 1 Ruda.

Apana 2. Aina Kala. E hoimaka ana, akau o kahi wai, Mahama, ka inoa, ma ke Pihik Ak. Hik. ma Loi. Nawi; alaila aku, Hem. 45. Hik. 3⁵⁰/₁₀₀ Kaul. e pili ana ina Loi. Nawi; Ak. 58. Hik. 1⁹⁰/₁₀₀ Kaul. e pili ana i ke Kula; Ak. 39. Kom. 4²⁰/₁₀₀ Kaul. e pili ana ina Loi. Hanaimoa; Hem. 40. Kom. 2⁴⁰/₁₀₀ Kaul. e pili ana ma kahi auwai ma Kula, e ili ana 3 Ruda, 2 Perka.

Hawaii Sept. 3. 1852
W. H. Pease

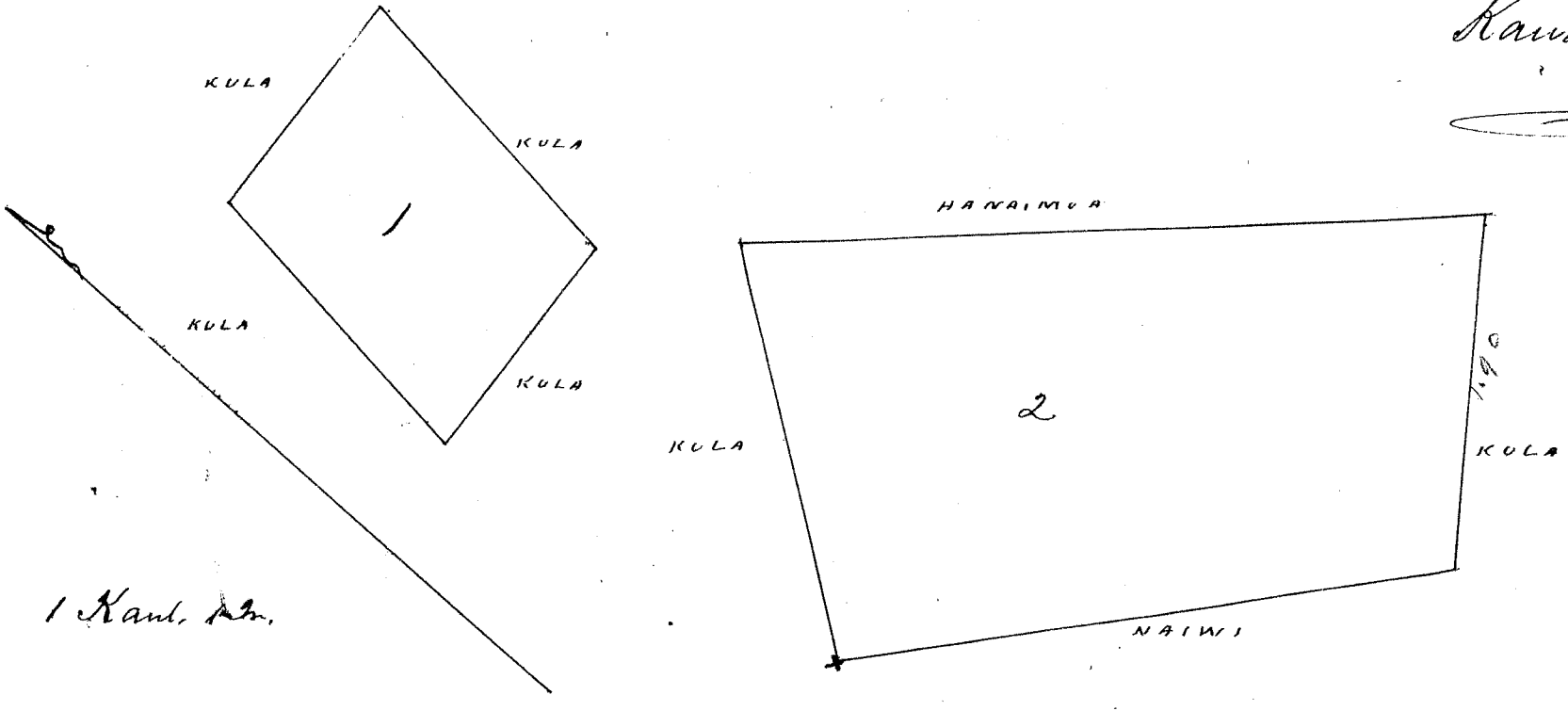

Wku Pau Loa \$5.
W. H. Lee
G. M. Robertson
J. Kekaulahao
J. H. Smith

Honolulu 5 Oct 1852.

Kolu 9081 Kape

Hanalei, Hawaii

Maloko o ke Ahupuaa o Waioli, Halelika, Hawaii.

Apana 1. E kolu Loi, o "Kapailoli" ka inoa, Penei ma Mookuna, E hoimaka ana ma ka wai o Waikeunono, ma kahi pahu laau, alaila, Ak. 55. Kom. 40 pauter, e pili ana i ke Kula o Konohiki; Hem. 27. Kom. 3⁶⁰/₁₀₀ Kaul. e pili ana i ka pali o Waikeunono, Hem. 55. Hik. 30 pauter, e pili ana i ke Kula; Ak. 48. Hik. 2 Kaul. e pili ana i ka wai o Waikeunono, Ak. 8. Hik. 1⁸⁰/₁₀₀ Kaul. e pili ana i ka wai o Waikeunono, e ili ana 3 Perka.

Apana 2. Chiku Loi, "Lupa" ka inoa, Penei ma Mookuna, E hoimaka ana ma ka pali ma ke alanui i Hanalei, alaila aku, Hem. 84. Hik. 2⁵⁰/₁₀₀ Kaul. e pili ana i ke alanui i Hanalei; Ak. 65. Hik. 1⁵⁰/₁₀₀ Kaul. e pili ana ina Loi. Nawi; Ak. 84. Kom. 1⁷⁵/₁₀₀ Kaul. e pili ana ina Loi. Lewi; Ak. 65. Hik. 4⁵⁰/₁₀₀ Kaul. e pili ana Loi. Lewi; Ak. 8. Kom. 1⁵⁵/₁₀₀ Kaul. e pili ana ina Loi. Nawi; Hem. 65. Kom. 3⁸⁵/₁₀₀ Ak. e pili ana ma ke Kula; Ak. 84. Kom. 1. Kaul. e pili ana i ke Kula; Hem. 40. Kom. 3 Kaul. e pili ana ina Loi o Kauhilina, e ili ana 1 Perka.

Apana 3. Pahale. Peni na Mokuna. Choomaka ana ma ke atamui koke i ke kai ma kahi pahu luan, Hem. 33. Nih. 1 Kaul. e pili ana i ke Pula. Konohiki, Ak. 84. Nih. 2. Kaul. e pili ana i kahi atamui, i ka hale pule, Ak. 33. Kom. 2 Kaul. e pili ana i ke Pula. Hem. 55. Kom. 18⁰/₁₀₀ Kaul. e pili ana i ke atamui aupuni, i ili ana i Ruda, Kaul. 1. Ruda, N. H. Pease, Sept. 3. 1852.

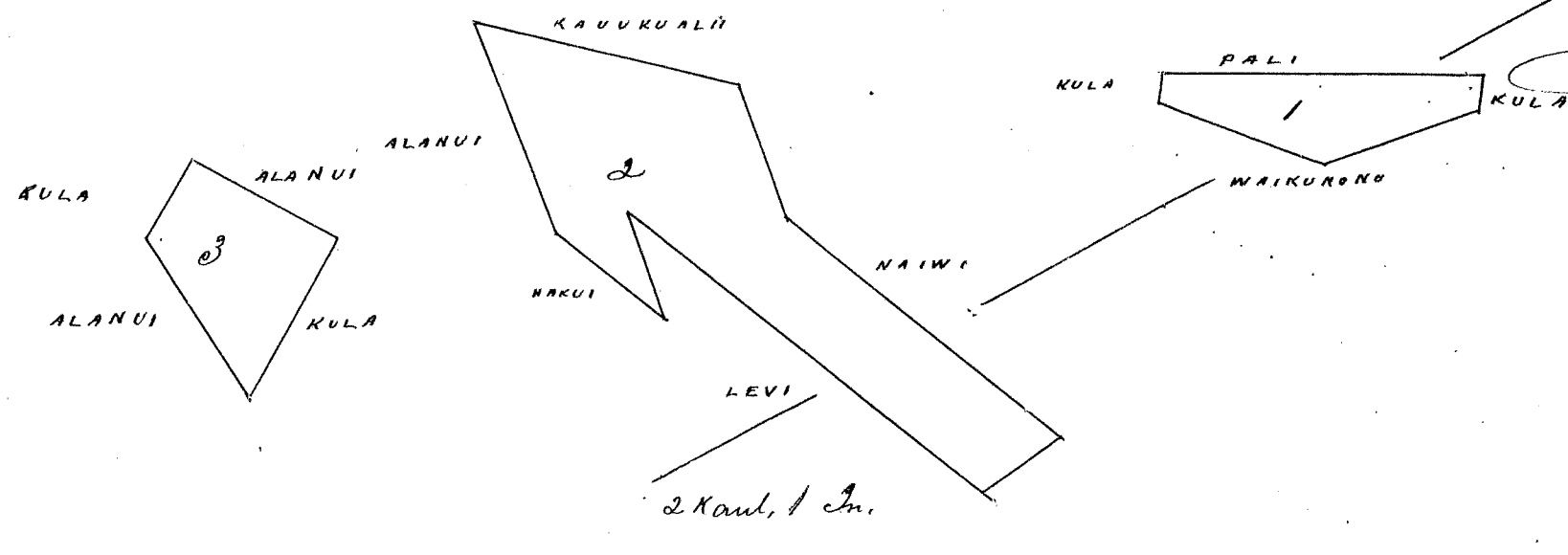

34 P
16.18
E. 074 P

Uku Pau Loa / 5.
W. H. Pease
G. M. Robertson
J. Kekaulahao
J. H. Smith

Honolulu 5 Oct. 1852.

Heleu 8125 Hanaimoa

Hanalei Kauai.

Maloko, ke Ahupua. Hanalei, Hanalei, Kauai.
Apana 1. Kahi Loi. Kahuani ka imua, Peni na Mokuna. Choomaka ana ma ke kahi o ma Loi o Naiwi, Ak. Komohana, Hem. 35. Nih. 2 Kaul. e pili ana ina Loi o Naiwi, Ak. 35. Nih. 1. ¹⁶/₁₀₀ Kaul. e pili ana i kahi Loi. Konohiki, Ak. 35. Kom. 2 Kaul. e pili ana ina Loi o Namau, Hem. 35. Kom. 1 ¹⁶/₁₀₀ Kaul. e pili ana i ke Pula, e ili ana 35. Perka.

Apana 2. Aina Kalo, maloko, ka ili o Mahaana, Peni na Mokuna, Choomaka ana ma ke kahi o ma Loi o Namau, Ak. Nih. alaila aku, Hem. 31. Nih. 4. ⁵⁰/₁₀₀ Kaul. e pili ana ina Loi o Namau, Ak. 35. Nih. 3. ⁵⁰/₁₀₀ Kaul. e pili ana ina Kula, Ak. 49. Kom. 2 ⁵⁰/₁₀₀ Kaul. e pili ana ina Loi o Bekeke, Hem. 38. Kom. 3 ⁵⁰/₁₀₀ Kaul. e pili ana i ke Pula ma ke Kapa a. ka wai o Mahaana, e ili ana, i. Eka, 2 Ruda, 14 Perka.

Hanalei Sept 3. 1852
W. H. Pease.

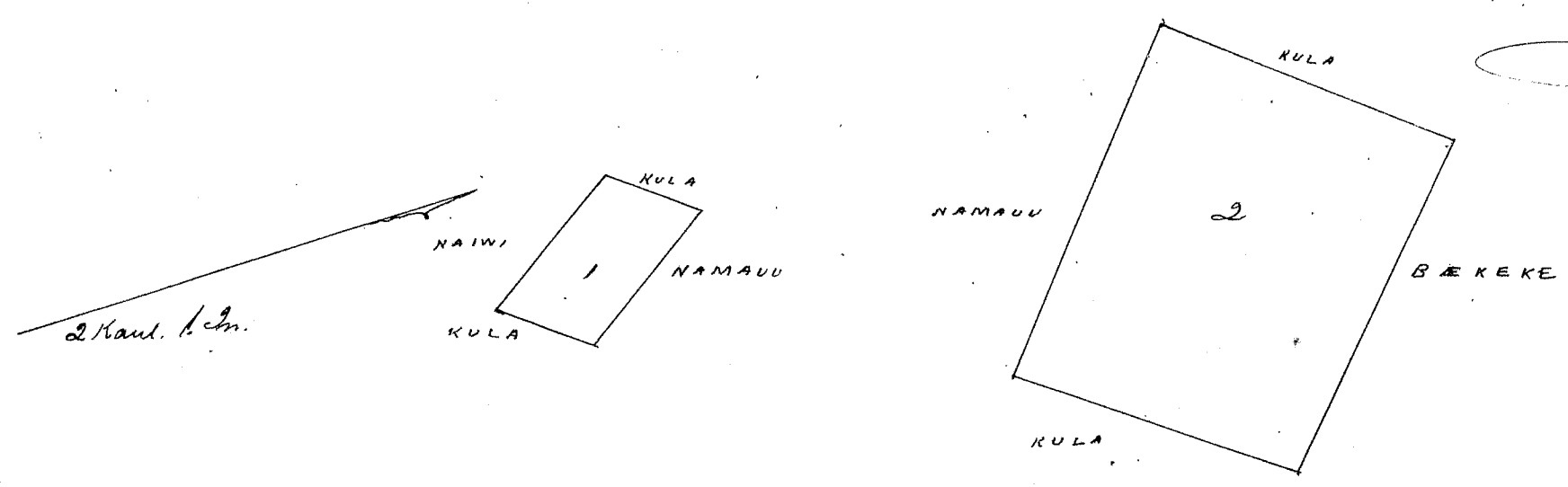

Uku Pau Loa / 5.
W. H. Pease
G. M. Robertson
J. Kekaulahao
J. H. Smith

Honolulu 5 Oct. 1852.

Hulu 9833 Kouaehu

Kaioli Kawai

Akahi Loi "Momonā" ka inoa Maloko, he Ahupuaa o Kaioli Halelea Kawai; Penei na motuana, E hoomaka ana ma ke Kahawai o Kaioli, Ahohe i ka aina o ma Misionari, alaila aku, Hem. 33' Kom. 1 Kaul. e pili ana i ke alanui, Hem. 55' Hik. 3 35/100 Kaul. e pili ana i ke alanui; Ak. Loi. Hik. 1 Kaul. e pili ana ina Loi Puali; Ak. 54' Kom. 3 89/100 Kaul. e pili ana ina Loi e Nihakala, e ili ana 1 Eka, 1 Ruda, 29 Perka,

Kouai, Sept 3, 1852
W. H. Pease

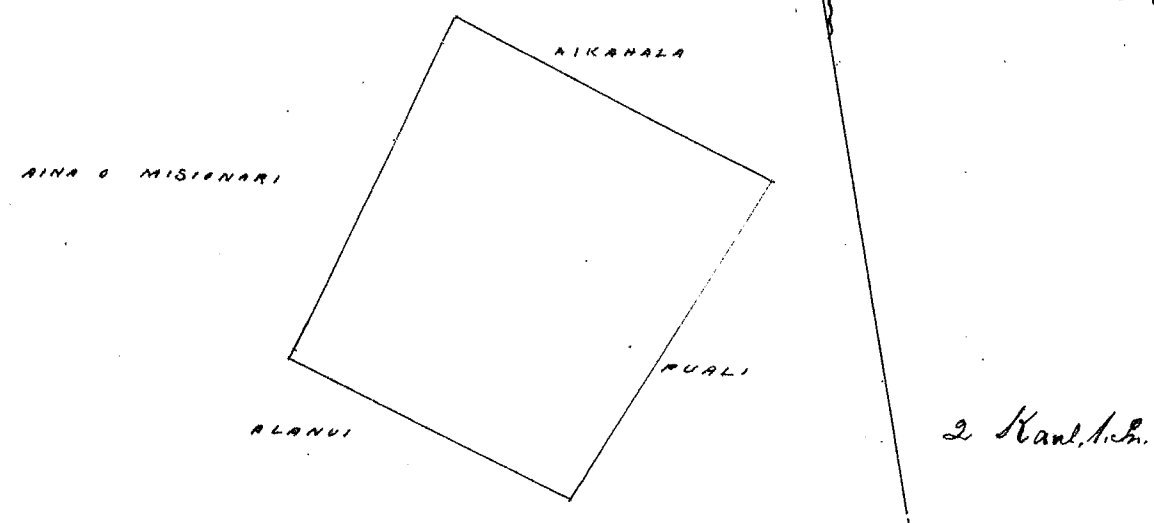

W. H. Pease

W. H. Pease
G. M. Robertson
J. Akoualahao
J. H. Smith

Honolulu, 5. Oct. 1852

Hulu 10074 Mana

Kaioli Kawai

Maloko, he Ahupuaa o Kaioli Halelea Kawai.

Apana 1. Pahale, maloko, he ili o Kalena, Kaioli; E hoomaka ana ma kahi pahu laau, Ahohe i ke alanui; ma kahi o "Lohomaiikai" ka inoa, alaila aku, Ak. 70' Hik. 1 50/100 Kaul. e pili ana i ke alanui; Hem. 20' Hik. 1 75/100 Kaul. e pili ana i ke Kula o Konohiki; Hem. 70' Kom. 1 50/100 Kaul. e pili ana i ke Kula o Konohiki; Ak. 20' Kom. 1 75/100 Kaul. e pili ana i ke Kula o Konohiki; e ili ana 1 Ruda,

Apana 2, Akahi Loi "Kaumamui" ka inoa, Penei na motuana, e hoomaka ana ma kahi koele, ma ke Kahi Ak. Kom. Hem. 53' Kom. 2 50/100 Kaul. e pili ana ina Loi o Koenapuu Hem. 34' Hik. 2 10/100 Kaul. e pili ana ina Loi o Kahookane, Ak. 62' Hik. 2 25/100 Kaul. e pili ana ina Loi o Joane, Ak. 29' Kom. 2 55/100 Kaul. e pili ana i ke Koele, e ili ana 2 Ruda, 8 Perka,

Kouai, Sept. 3, 1852
W. H. Pease

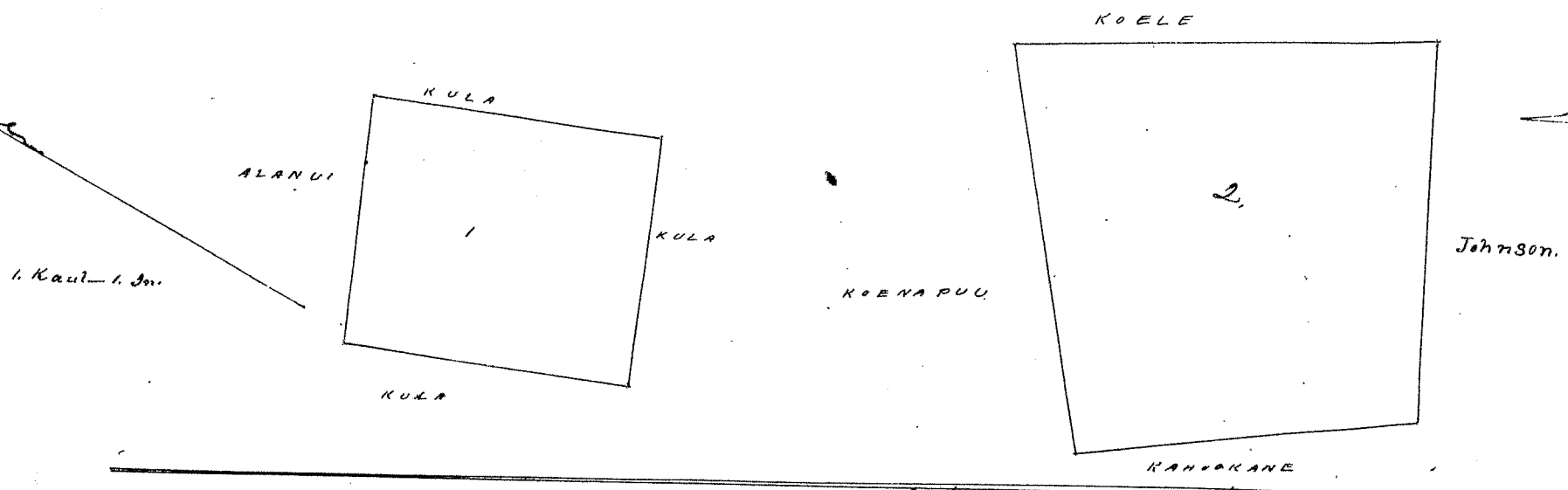

W. H. Pease

W. H. Pease
G. M. Robertson
J. Akoualahao
J. H. Smith

Honolulu, Oct. 5, 1852

Heleu 9276 Keiolea

Waioli, Hawaii.

Maloko. ke Ahupuaa. Waioli Halekua Hawaii.

Apana 1. Pahale maloko. ke Ahupuaa o Hanalei; E hoomaka ana ona ke alanui aupuni; ma ke kahi Ak. Hik. o ka pahale. Kounapuu, alaila aku, Nem. 37; Hik. 1 6/100 Kaul. e pili ana i ka pahale o Kounapuu Ak. 2; Hik. 1 6/100 Kaul. e pili ana i ke Puia o Konohiki, Ak. 37; Nem. 1 6/100 Kaul. e pili ana i ke Puia. Konohiki Nem. 2; Kom. 1 6/100 Kaul. e pili ana i ke alanui; e ili ana 1 Ruda.

Apana 2. Aina Kalo Kuhimana ka inoa, E hoomaka ana ona kahi auwai; ma ke kahi Ak. Hik. o ka aina o Kaluha, Nem. 30; Hik. 5 50/100 Kaul. e pili ana ina Loi. Kaluha, Ak. 63; Hik. 1 Kaul. e pili ana i ka pali o Kuhimana, Ak. 30; Kom. 5 50/100 Kaul. e pili ana, ina Loi o Kuaua, Nem. 63; Kom. 1 Kaul. e pili ana i kahi auwai; e ili ana 2 Ruda, 6 Perka.

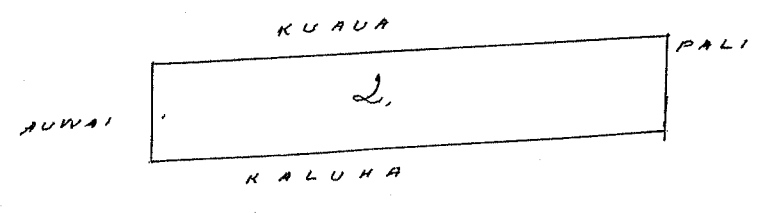
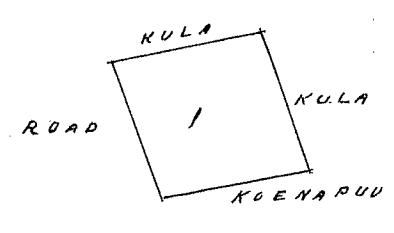

2 Kaul. 1 In.

Hawaii, Sept. 3, 1852
W. H. Pease

Uku Pau Loa \$ 5

W. H. Pease
G. M. Robertson
J. Kekaulaheo
J. H. Smith

Honolulu 5 Oct 1852.

Heleu 9072 Keolo

Waioli, Hawaii.

Maloko. ke Ahupuaa. Waioli Halekua Hawaii.

Apana 1. Pahale. Penei ma Mookuna, E hoomaka ana ona ke Kahawai. Waioli; ma ke Kapa Hikina ona kahi pahu laau, Nem. 27; Hik. 1 75/100 Kaul. e pili ana i ke Kahawai o Waioli, Ak. 51; Hik. 1 75/100 Kaul. e pili ana i ke Puia o Konohiki, Ak. 47; Nem. 1 75/100 Kaul. e pili ana i ke Puia o Konohiki; Nem. 31; Kom. 1 75/100 Kaul. e pili ana i ke Puia o Konohiki; e ili ana 1 Ruda 7 Perka.

Apana 2. Aina Kalo, Penei ma Mookuna, E hoomaka ana ona ke auwai o Waioli; ma na Loi. Pipiwai, alaila aku, Nem. 39; Hik. 5 Kaul. e pili ana i ka auwai, Waioli; Nem. 10; Kom. 1 75/100 Kaul. e pili ana i ka auwai o Waioli; Ak. 81; Kom. 2 75/100 Kaul. e pili ana ina Loi o Kawahine, Ak. 10; Kom. 1 50/100 Kaul. e pili ana ina Loi. Makaka, Ak. 9; Hik. 2 20/100 Kaul. e pili ana ina Loi. Pipiwai, Ak. 10; Kom. 1 50/100 Kaul. e pili ana ina Loi. Pipiwai; e ili ana 1 Eka.

Apana 3. Chiku Loi; me Kula, E hoomaka ana ona ke wai o Waiunono - Kokohe i ke alanui aupuni; alaila aku, Ak. 22; Kom. 2 Kaul. e pili ana i ke Puia o Konohiki, Ak. 26; Hik. 2 20/100 Kaul. e pili ana i ke Puia o Konohiki, Ak. 75; Hik. 2 86/100 Kaul. e pili ana, ina Loi. Hakui, Nem. 23; Hik. 26 pautu, e pili ana ina Loi. Hakui, Nem. 76; Kom. 52 pautu, e pili ana ina Loi o Hakui, Nem. 10; Hik. 3 Kaul. e pili ana i ke Puia, Nem. 75; Kom. 3 30/100 Kaul. e pili ana i ka wai o Waiunono, e ili ana 1 Eka, 30 Perka.

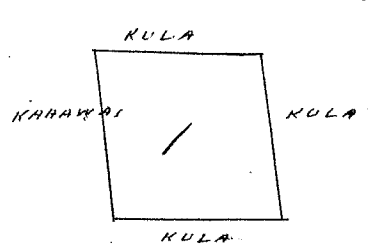
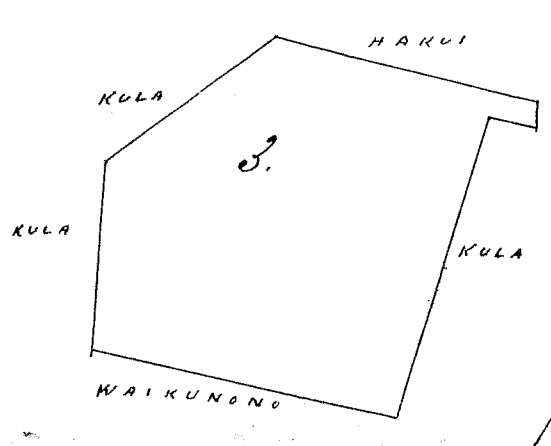

2 Kaul. 1 In.

Hawaii, Sept. 3, 1852

W. H. Pease

P. L. Lee
G. M. Robertson
J. Kekaulahao

J. H. Smith

Honolulu 5 Oct 1852

Kelle 2444 Keawekuhia

Kaneohe Oahu

Apana 1. Ke moana i loko. Kahoiki, Kaneohe, Oahu.
E hoomaka ma ke Pihikoma e hule ana. Aka 60. Nihina i 2.10 Kaulahao,
ma Kahawai; Malaila aku, Aka 3. Nihina i 5.50 Kaulahao, ma Waikalua,
Malaila aku, Aka 58. Komohana i 2.15 Kaulahao, ma Mikiola, Malaila aku,
Aka 50. Komohana i 1.10 Kaulahao, ma ka palena o Paele, Malaila aku,
Aka 41. Komohana i 4.20 Kaulahao, ma ko Paele. 1 Eka, 2 5/100 Kaulahao huinaha

Apana 2. Kahuahale i Kahawai; Waikalua waho.
E hoomaka ma ke Pihikoma e hule ana. Aka 45 1/2. Nihina i 1.70 Kaulahao,
ma ka palena o Konoiki; Malaila aku, Aka 16. Nihina i 3.60 Kk ma na Kio
i Kahawai; Malaila aku, Aka 27. Komohana 1.80 Kaulahao, ma Kahakai;
Malaila aku, Aka 11. Komohana i 4.20 Kaulahao, ma ka pa. Paele,
Aka 6 48/100 Kaulahao huinaha.

A. Bishop.
Mea ana.

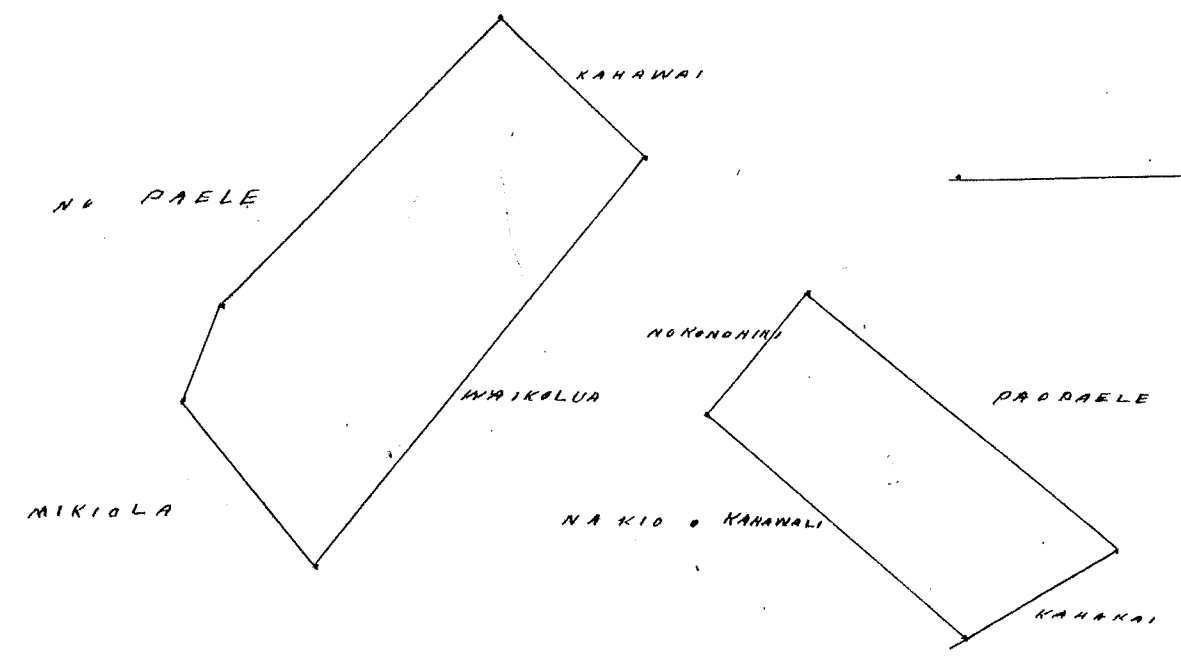

P. L. Lee
G. M. Robertson
J. Kekaulahao
J. H. Smith

Honolulu 12 Oct 1852

Kelle 2843 Kaanaana

(S 635 15)

Waikiki Oahu

Ke Kahuahale i loko. Kamehame, Waikiki, Oahu.
E hoomaka ma ke Pihikoma e hule ana. Aka 60. Nihina i 1.60 Kaulahao, ma ka
palena o Muanale, Malaila aku, Aka 30. Nihina i 1.60 Kaulahao, ma ka Muliwai,
Malaila aku, Aka 60. Komohana i 1.60 Kaulahao, ma ka palena o Konoiki;
Malaila aku, Aka 30. Komohana i 1.60 Kk, a hiki i ka hoomaka ana, 2 5/100 Kaulahao
huinaha

A. Bishop
Mea ana.

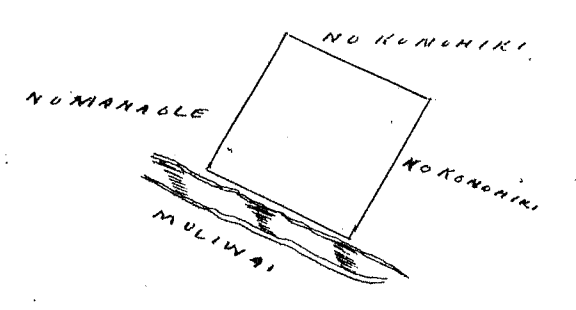

Wm Pau Lou & Co

N. L. Lee
G. M. Robertson
J. Kekaulahao
J. H. Smith

Honolulu, 12 Oct. 1852.

Helu 9215 Kaahu

Wainiha Kauai

Aina Kalo me Kula maloko. ka Ili. Kapohaku, Wainiha, Halea, Kauai. Puni na Motuna.
E hoomaka ana ma kahi auwai, ona ke Kahi Akau, Komoana, ka aina. Pamaia, alaila alu,
Akau 66° Kom. 18 1/2 Kaul. e pili ana ina Loi o Konoiki; Akau. 20; Hikina 6 Kaul. e pili ana i ke
Kula. Konoiki, Kom. 63° Hik. 18 1/2 Kaul. e pili ana i ke Kula o Konoiki; Kom. 20. Kom. 18
Kaul. e pili ana i kahi auwai, Kom. 50° Kom. 1 1/2 Kaul. e pili ana i kahi auwai; e ili ana 1 Eka
o Ruda. o Perka,

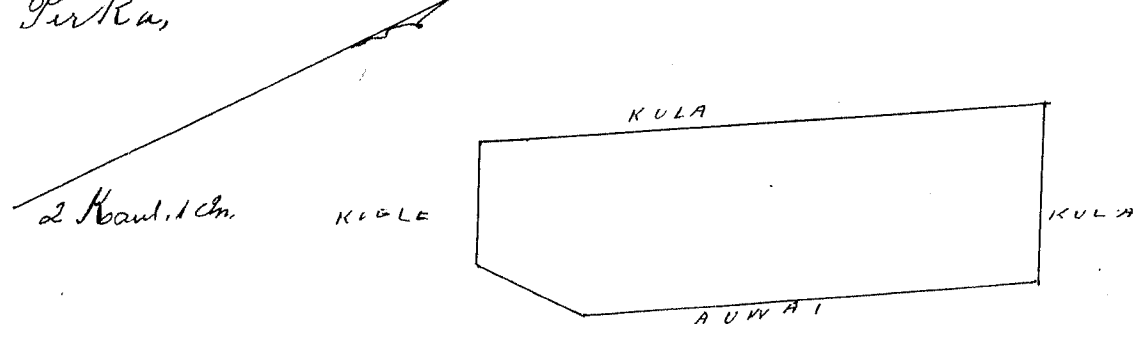

Kauai Sept 3 1852.
W. H. Pease

Wm Pau Lou & Co

N. L. Lee
G. M. Robertson
J. Kekaulahao
J. H. Smith

Honolulu, 5 Oct. 1852.

Helu 9266 Keikinui

Wainiha Kauai

Aina Kalo me Kula, maloko. ka Ili o Owi, Wainiha, Halea, Kauai. Puni na Motuna.
E hoomaka ana ma ke Kahi Akau Hikina. ka aina o Kahi, alaila, Kom. 57° Hik. 4 Kaul.
e pili ana ina Loi o Kahi. Akau. 40; Hik. 2 1/2 Kaul. e pili ana i ka pali; Ak. 57°
Kom. 4 Kaul. e pili ana ina Loi o Konoiki; Kom. 40° Kom. 2 1/2 Kaul. e pili ana i
ke Kula o Konoiki; e ili ana 1 Eka, 15 Perka,

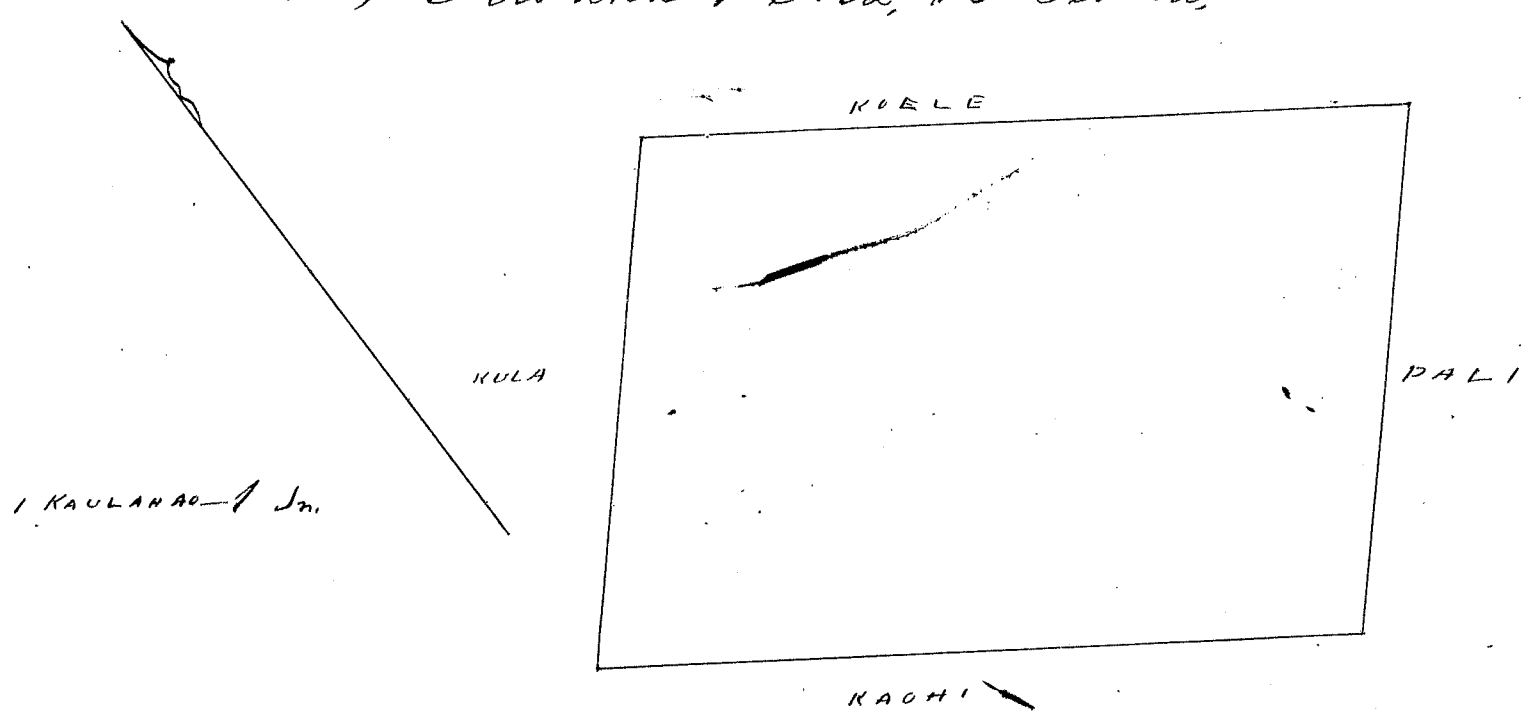

Kauai, Sept. 3, 1852
W. H. Pease

Wm Pau Lou & Co

N. L. Lee
G. M. Robertson
J. Kekaulahao
J. H. Smith

Honolulu Oahu, 5, 1852

Matoko o ke Ahupuaa, o Kauihi Halilea, Kauai

Apana 1. Pahale, matoko o ka ili o Kamaikahiki; Penei na Mokuna, Chomata ana ma kahi pahu laau, ma ke alanui Aupuni; Hem. 36, Hk 2 Kaul. e pili ana i ka pahale o Nanihi, Ak. 36, Hk 1 5/100 Kaul. e pili ana i ke Kula Komohiki; Ak. 36, Kom. 2 Kaul. e pili ana i ka pahale o Nanihi, Hem. 36, Kom. 1 5/100 Kaul. e pili ana i ke alanui, e ili ana i Ruda, 8 Perka.

Apana 2. Kula, matoko o ka ili o Ahau, Penei na Mokuna, Chomata ana ma ke Kula o Kahokane, Kokohe i ke Pihia Nema Komohana, alaila aku. Hem. 56, Kom. 55 pautu, e pili ana i ke Kula o Komohiki; Ak. 48, Kom. 1 90/100 Kaul. e pili ana i ke Kula o Komohiki; Ak. 56, Hk. 55 pautu, e pili ana i ke Kula o Komohiki; Hem. 48, Hk. 1 1/100 Kaul. e pili ana i ke Kula o Kahokane, e ili ana 16 Perka.

Apana 3. Akahi Loi; matoko o ka ili o Kapuoni, Penei na Mokuna, Chomata ana ma kahi auwai, ma ke Pihia Ak. Kom. o na Loi o Emilia Ak. 59, Hk. 2 Kaul. e pili ana i na Loi o Emilia, Ak. 30, Kom. 1 1/100 Kaul. e pili ana i na Loi o Kaniela, Hem. 59, Kom. 2 Kaul. e pili ana i na Loi o Kawahine, Hem. 30, Hk. 1 10/100 Kaul. e pili ana i ka auwai, e ili ana 34 Perka.

Apana 4. Akahi Loi matoko o ka ili o Kapuoni, Penei na Mokuna, Chomata ana ma ke Pihia Ak. Hk. o ka Loi o Kaulu ka inoa, Hem. 57, Kom. 3 2/100 Kaul. e pili ana i ka Loi o Kaulu, Hem. 31, Hk. 1 Kaul. e pili ana i kahi auwai, Ak. 57, Hk. 3 2/100 Kaul. e pili ana i na Loi o Kaniela, Ak. 31, Kom. 1 Kaul. e pili ana ma na Loi o Kaniela, e ili ana 1 Ruda, 19 Perka.

Apana 5. Akahi Loi; matoko o ka ili o Kapuoni, Penei na Mokuna, Chomata ana ma ke Kula, ma ke Pihia Ak. Kom. o na Loi o Marko, Hem. 49, Kom. 1 Kaul. e pili ana i na Loi o Nahanu, Hem. 35, Hk. 58 pautu, e pili ana i na Loi o Daniela Ak. 49, Hk. 1 Kaul. e pili ana i na Loi o Kaniela, Ak. 35, Kom. 58 pautu, e pili ana i na Loi o Matoko, e ili ana 9 Perka.

1.8
16
34
1.19
9
160.6

Kauai Sept 3 1852
W. H. Pease

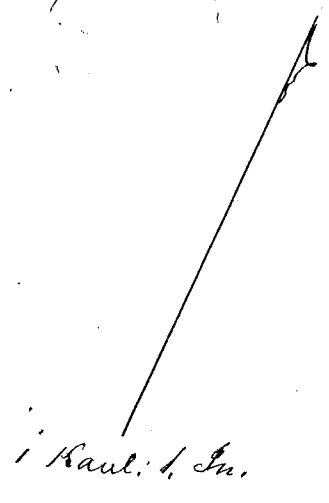
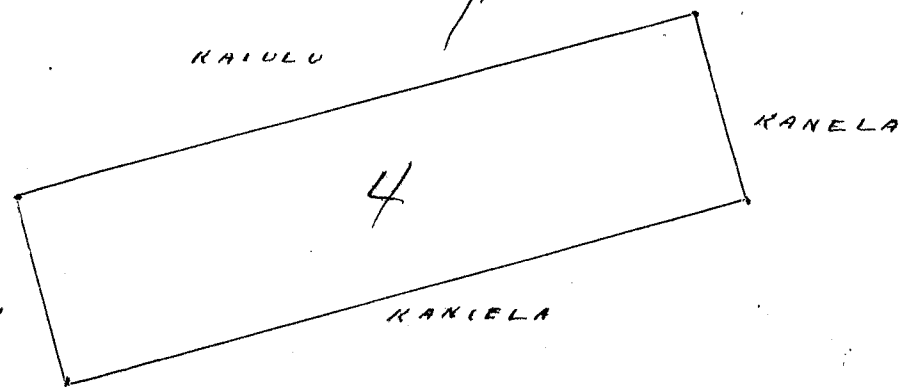
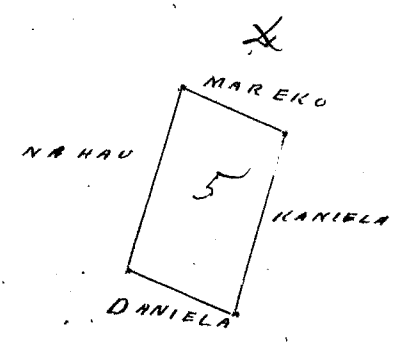
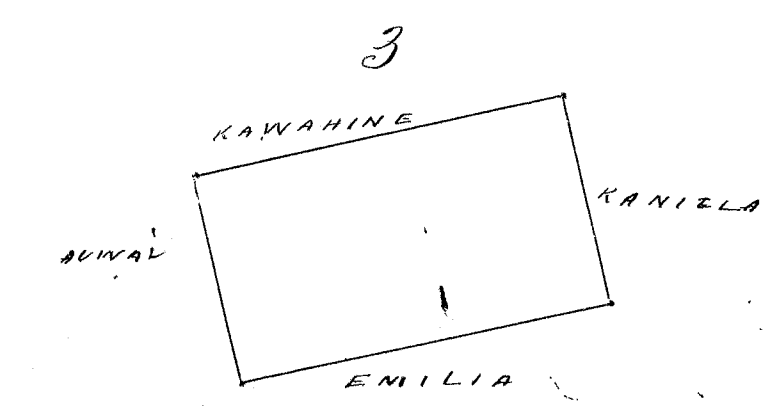
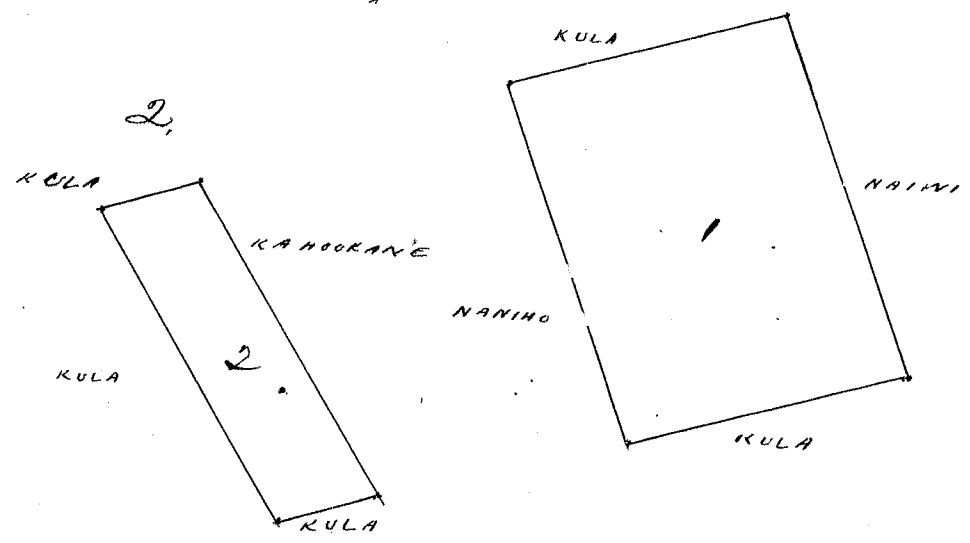

Wku Pau Loa p 6.
W. L. Lee
G. M. Robertson
J. H. Smith
J. Kekaulahas

Honolulu 5 Oct 1852.

Hele 9171 Koaaka - Mainika Kawai

Ma aloha o ke Ahupuaa. Mainika, Kalaia, Kawai,
Apana 1. Pahala, Penei ma Motuna. E hoomaka ana ma kahi laaukala, ma kapaia
alaila aku, Ak. 43. Nih. 2. 50/100, Kaul. e pili ana i ke Kula o Konohiki; Ak. 47. Kom 2.
Kaul. e pili ana i ke Kula o Konohiki; Hem. 43. Kom. 2 50/100 Kaul. e pili ana i ke Kula o
Konohiki; Hem 47; Nih. 2 Kaul. e pili ana i ke Kula o Konohiki; e ili ana 2 Ruda,

Apana 2. Akahi Loi "Kapaia" ka inoa, Penei ma Motuna. E hoomaka ana ma
ke alanui, ma ke Kahi Akau Kom. o ma Loi. Kimo, alaila aku, Hem. 45. Nih. 3. 60/100,
Kaul. e pili ana ina Loi. Kimo, Hem. 41. Kom 2 50/100 Kaul. e pili ana i ke Kula o Kon-
ohiki; Ak. 41. Kom 4 Kaul. e pili ana ina Loi. Maiki; Ak. 51. Nih. 2 Kaul. e
pili ana i ke alanui, e ili ana 3 Ruda, 12 Perka

Apana 3. Akahi Loi Uluka ka inoa, Penei ma Motuna. E hoomaka ana
ma ke alanui ma ke Kahi Akau Nih. o ma Loi. Kealai, alaila aku, Hem. 42. Nih.
3 Kaul. e pili ana ina Loi. Kealai, Ak. 46. Nih. 1 60/100 Kaul. e pili ana i ke Kula o Kon-
ohiki; Ak. 46. Kom. 3. Kaul. e pili ana ina Loi. Konohiki; Hem. 40. Kom 1 45/100 Kaul.
e pili ana i ke alanui, e ili ana 1 Ruda, 33 Perka,

Kawai, Sept. 3, 1852
W. H. Pease,

Olohoakaha

Okua ana maluna nei, ua hoolia, ua hoo pono
ma ka awa 481 Vol. 3, oia ana hoo pono loa
August 27, 1853
J. D. Nailili
Maui Kekaulahas

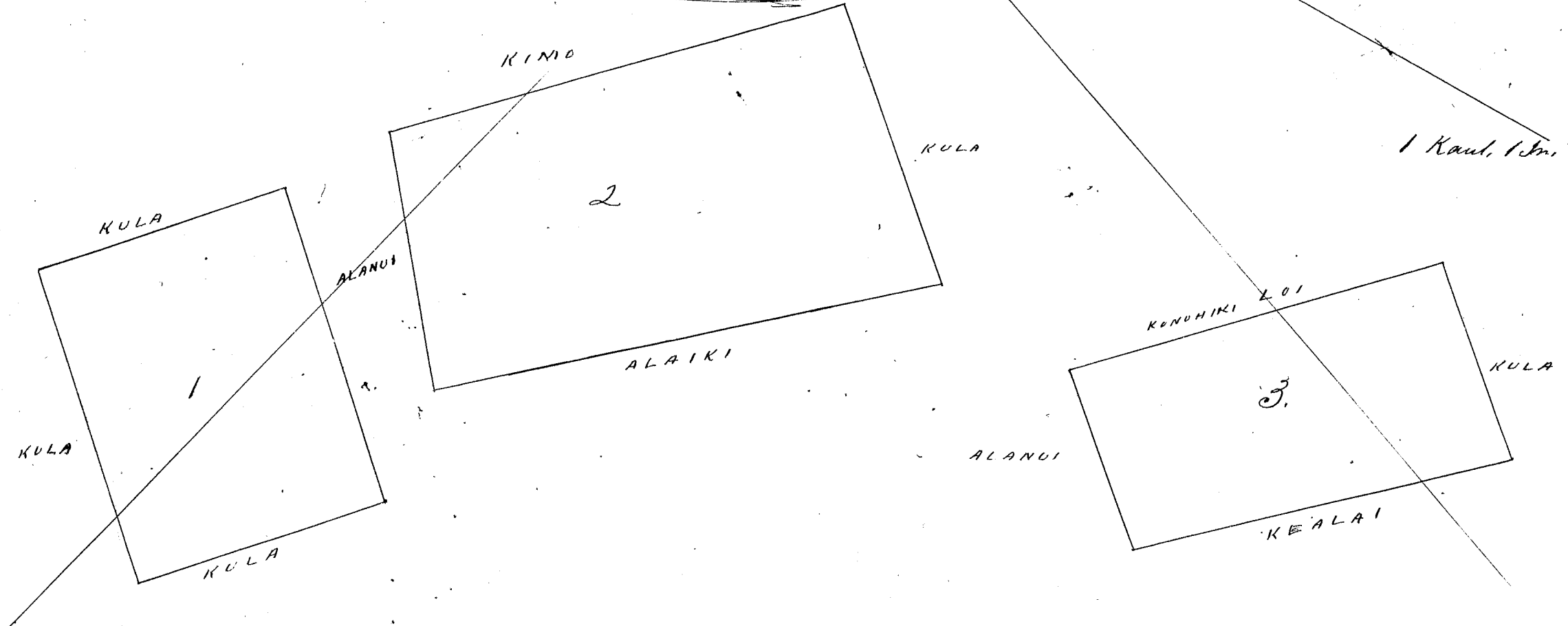

Wku Pau Loa p 5
W. L. Lee
G. M. Robertson
J. H. Smith
J. Kekaulahas

Honolulu 5 Oct 1852.

Maloko o ke Ahupuaa o Wainiha, Halelea, Kauai.

Apana 1, Pahala, maloko ka ili o Kapahala. Penei na motuna Choomaka ana ma ke Kula o Konohiki, ma kahi paku laau, Ak. 25. Kom 1 60/100 Kaul. e pili ana i ke Kula o Konohiki; Ak. 65. Hik 1 50/100 Kaul. e pili ana i ke Kula o Konohiki; Kom. 25. Hik. 1 60/100 Kaul. e pili ana i ke Kula o Konohiki; Kom. 65. Kom 1 50/100 Kaul. e pili ana i ke Kula o Konohiki; e ili ana 38. Perka.

Apana 2, Aina Kalo, Maloko ka ili o Kapahala, Penei na motuna Choomaka ana ma kahi paku laau, ma ka Loi o Peiho, me na Loi o ke Konohiki, ulaila Kom. 50. Hik. 2. 50/100 Kaul. e pili ana ina Loi o Peiho, Kom. 13. Kom. 4 90/100 Kaul. e pili ana i ke Kahawai, Ak. 55. Kom 4 Kaul. e pili ana ina Loi o Pumaia, Ak. 41. Hik. 1 70/100 Kaul. e pili ana ina Loi o Pumaia, Ak. 20; Kom. 1. Kaul. e pili ana ina Loi o Konohiki, Ak. 41. Hik. 2 50/100 Kaul. e pili ana ina Loi o Konohiki e ili ana 1. Eka, 2 Puda.

Kauai Sept. 3, 1852
W. H. Pease

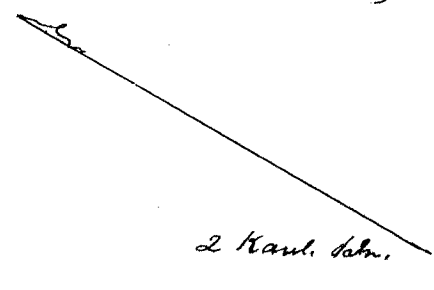
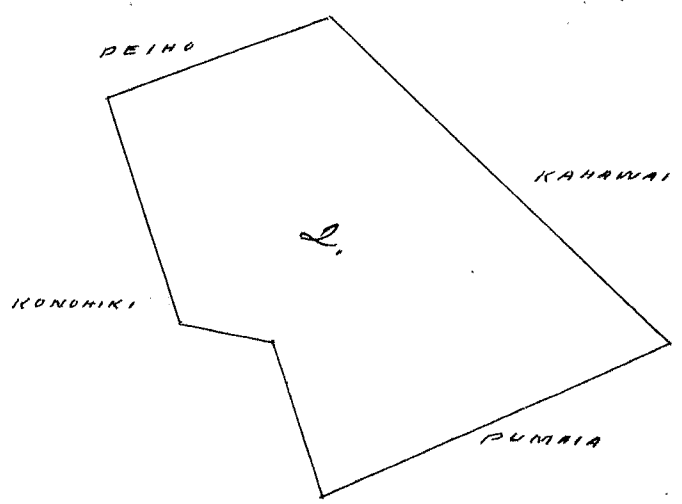
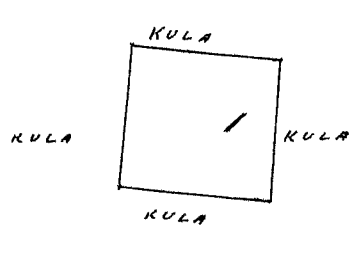

Wku Pau Loa # 5
W. L. Lee
G. M. Robertson
J. H. Kaulahao
J. H. Smith

Honolulu, 5. Oct. 1852.

Kawela, ili Mokuapuu, Molokai.

Choomaka ana ma ke Kahi Kikina, Akau oia aina, a e holo ana, Kom. 13. Kom. 738 Kaul. ma ke Maunaloa, ulaila, Ak. 68. Kom. 855 Kaul. ma ke Kai, ulaila, Ak. 10. Hik 287 Kaul. ma ke Konohiki, ulaila Ak. 82. Hik. 9.25 Kaul. ma ke Konohiki; a hiki i kahi i hoomaka ia, Ma ia Apana, 4 Eka 277 anana.

August 31, 1852

R. H. Meyer
Surveyor.

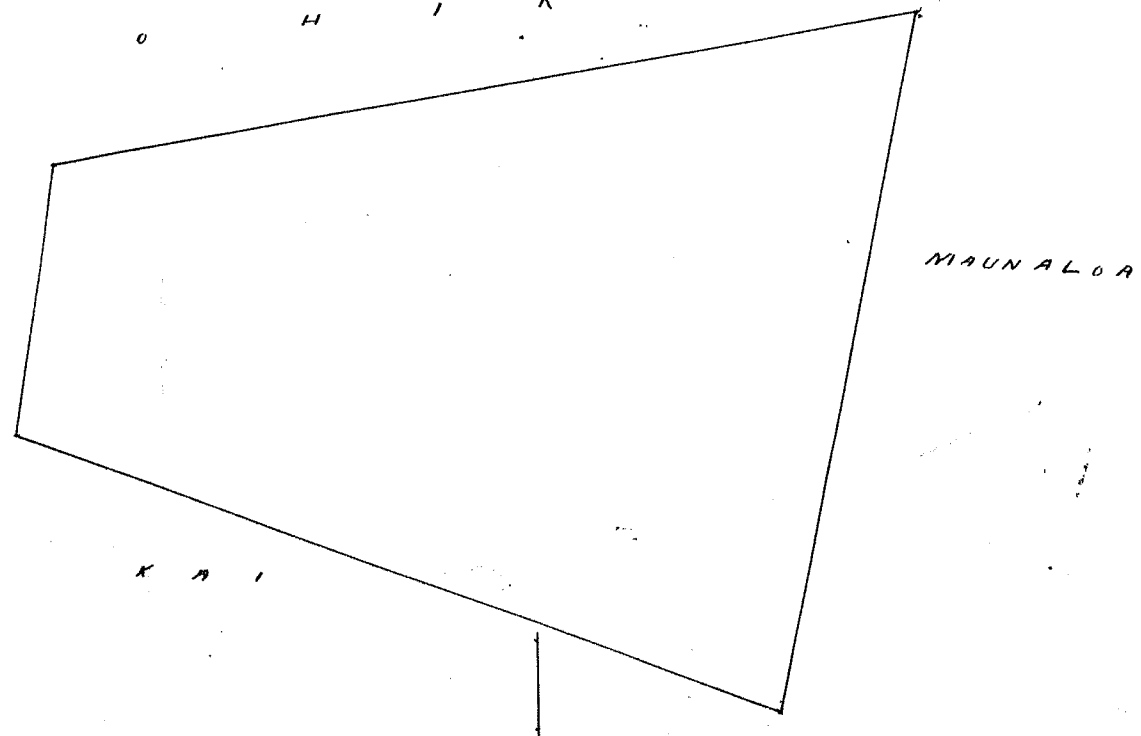

One 1/2 in. = 1 Kaul

Uku Pau Loa # 7
W. L. Lee
G. M. Robertson
J. Kekaulahao
J. H. Smith

Honolulu 13 Oct 1852.

Kelu 10110 Maalahia

Keawamui, Molokai

Ohia ili o Paakua, Molokai;

Apana 1. Ehoomaka ana ma ke Pihikina, Nema; oia aina a e holo ana, Ak. 14, Kom. 7,17 Kaul. ma ke Kauhiki; alaila, Ak. 86, Kom. 1,14 Kaul. ma ke Komohiki; alaila, Nema 16 1/4, Ak. 788. Kaul. ma ke Kaiamoku, Ak. 86 1/4, Ak. 3,68 Kaul. ma ke Namakaelua, a hiki i Kahi i hoomaka ia, ma ia Apana 1. Eka, 487 anana,

Apana 2. Tahale. E hoomaka ana ma ke Pihikina Komohana Akau, oia aina a e holo ana, Ak. 85 1/2, Ak. 1,68 Kaul. ma ke Alanui, alaila Nema 31, Ak. 2,28 Kaul. ma ke Manawai; alaila Nema 7 1/2, Kom. 2,62 Kaul. ma ke Kahookana, alaila Ak. 8, Kom 2,75 Kaul. ma ke Keili, a hiki i Kahi i hoomaka ia, ma ia Apana, 738 anana.

Augate, 30, 1852

R. W. Meyer
Surveyor.

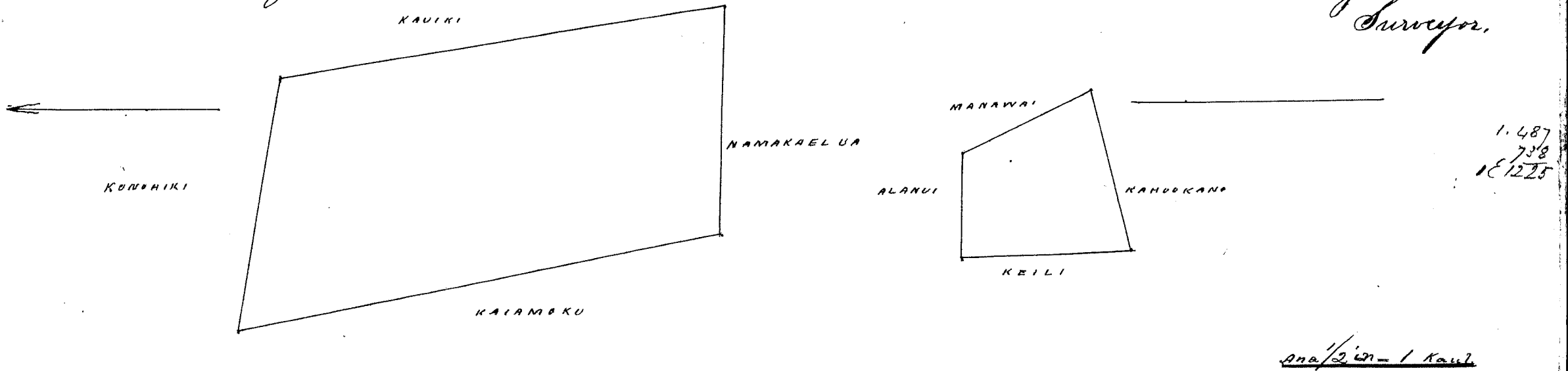

Uku Pau Loa # 5
W. L. Lee
G. M. Robertson
J. Kekaulahao
J. H. Smith

Honolulu 13 Oct 1852.

Kelu 4090 Kauhiki

Keawamui, Molokai

Keawamui, ili Kaitupa Molokai.
E hoomaka ana ma ke Pihikina, Akau, oia ~~aina a e holo ana, Ak. 11, Kom. 8,35 Kaul.~~
ma ke Alanui, alaila, Nema 34 1/4, Ak. 2,28 Kaul. ma ke Kumu, alaila, ~~11, Kom. 2,28 Kaul.~~
ma ke Kauhiki, a hiki i Kahi i hoomaka ia, ma ia Apana, Eka 506 anana,
6 Eia ma ke Komohiki, ma aloha oia Kuleana.

Augate 30, 1852.

R. W. Meyer,
Surveyor.

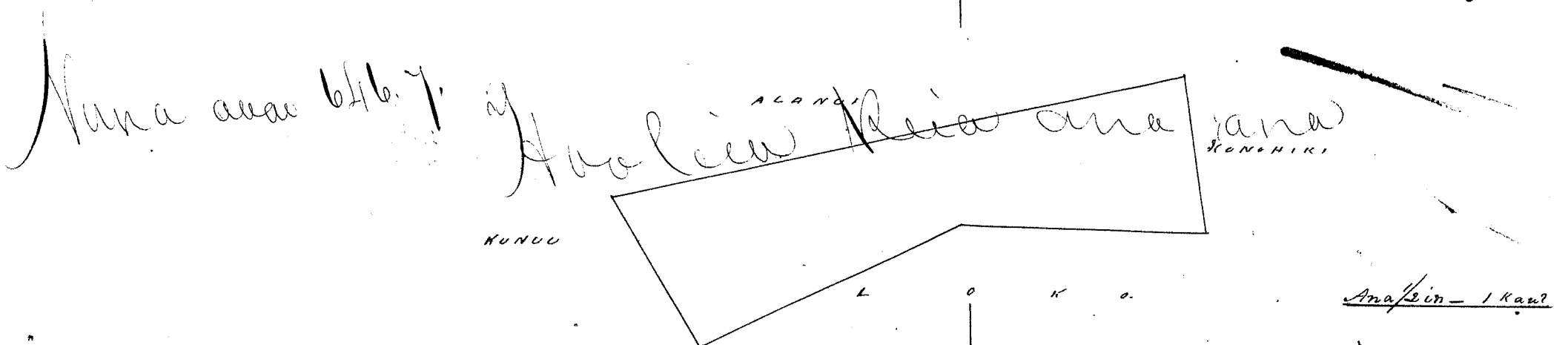

Uku Pau Loa # 5
W. L. Lee
G. M. Robertson
J. Kikaulaha
J. H. Smith

Honolulu 13 Oct 1852

Heleu 5193 Keaiamoku

Keawanui Molokai

Keawanui, ili. Ohaipele, Molokai;

Apana 1 Pahale, Chomaka ana ma ke Pihī Komoana, Komo, oia aina a e holo ana
Ak. $81\frac{1}{4}$; Hik. 2.27 Kaul. ma ke Kawainui, alaila Ak. 20 ; Kom. 185 Kaul. ma ke Kawainui
alaila, Kom. $82\frac{1}{2}$; Kom. 2.24 Kaul. ma ke Alanui, alaila, Kom. 185; Hik. 185 Kaul. ma ke
Konoiki; a hiki i Kahi i hoomaka ia, Maia Apana 588 anana,

Apana 2, Kula, Chomaka ana ma ke Pihī Komo oia aina, a e holo ana,
Ak. 13 ; Hik. 3.80 Kaul. ma ke Namakaelua, alaila Ak. 20 ; Kom. 10.13 Kaul. ma ke
Malahia, alaila, Kom. $14\frac{1}{2}$; Kom. 2.80 Kaul. ma ke Konoiki, alaila Kom. $26\frac{1}{2}$;
Hik. 11.00 Kaul. ma ke Konoiki; a hiki i Kahi i hoomaka ia, Maia Apana 1 Eka,
1070 anana,

Augate 30. 1852.

R. M. Meyer
Surveyor.

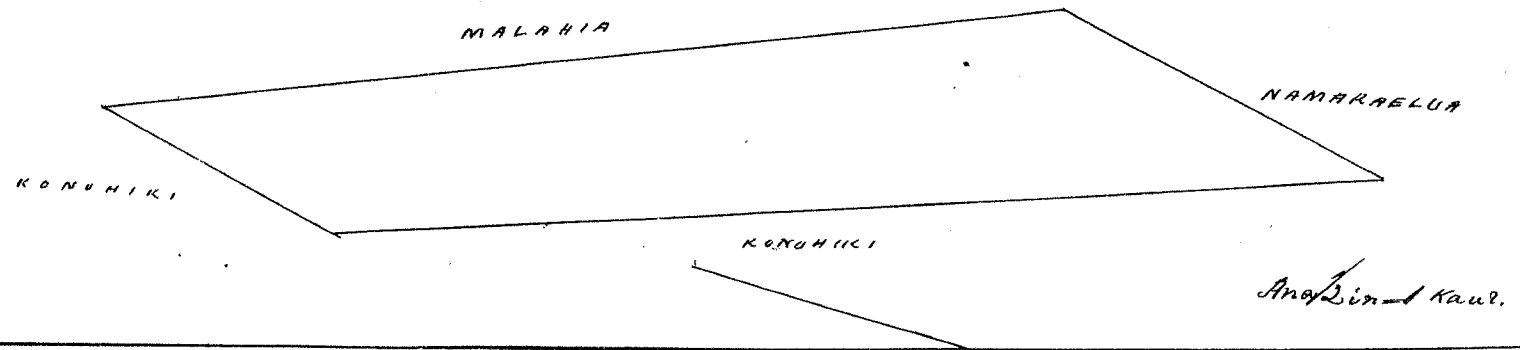
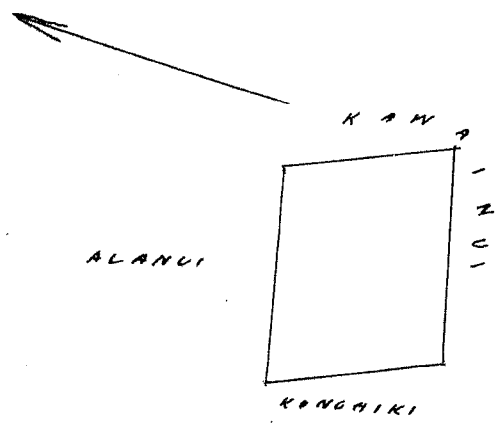

508
897
1578
124
26.568

Uku Pau Loa # 5
W. L. Lee
G. M. Robertson
J. Kikaulaha
J. H. Smith

Honolulu 13 Oct 1852

Heleu 4923 Mahae

Kalawao, Molokai

Kalawao, ili. Wailua Molokai;

Apana 1. Pahale, Chomaka ana ma ke Pihī Komo oia pa, a e holo ana, Ak. $49\frac{1}{2}$;
Kom. 2.00 Kaul. ma ke Aupuni; alaila, Ak. $50\frac{1}{2}$; Hik. 2.32 Kaul. ma ke Aupuni;
alaila, Kom. $49\frac{1}{2}$; Hik. 2.00 Kaul. ma ke Aupuni; alaila, Kom. $50\frac{1}{2}$; Kom. 2.32 Kaul.
ma ke Aupuni; a hiki i Kahi i hoomaka ia, Maia Apana, 526 anana,

Apana 2, Kula, Chomaka ana ma ke Pihī Komo, Akau, oia aina, a e holo ana,
Ak. $66\frac{3}{4}$; Kom. 4.00 Kaul. ma ke Aupuni; alaila, Kom. $23\frac{1}{4}$; Kom. 19.9 Kaul. ma
ke Paale; alaila, Kom. $66\frac{3}{4}$; Hik. 4.00 Kaul. ma ke Paale, alaila Ak. $23\frac{1}{4}$; Hik. 2.00
Kaul. ma ke Paale; a hiki i Kahi i hoomaka ia, Maia Apana 8 Eka,

Augate 30. 1852

R. M. Meyer
Surveyor.

Area 1/2 in = 1 Kaul.

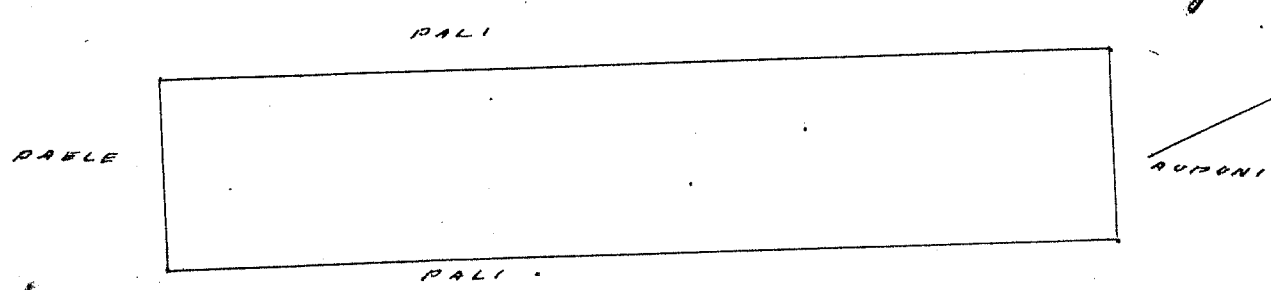
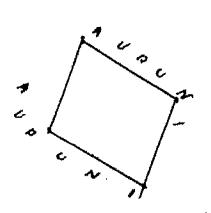

Wku Pau Loa # 7
H. L. Lee
G. M. Robertson
J. Hekeaulahao
J. H. Smith

Honolulu 13 Oct 1852

Hulu 4951 Kailua + 582 1/2

Waikolu & Molokai

~~Waikolu ili .. Molokai~~

~~Apana 1 Kula. Choomaka ana ma ke Pihia Akau oia aina, a e holo ana, Stem 32 1/2, Nihina 5.22. Kaul. ma ke Kai, alaila, Hem. 19, Kom. 1306 Kaul. ma ke Honohiki, alaila, Ak. 69 1/2, Kom. 2, 15 Kaul. ma ke Kula, Ak. 21; Nih. 8.05 Kaul. ma ke Kahiko, a hiki i kahi i hoomaka ia, Maia Apana, 6 Eka, 3,50 anana,~~

~~Apana 2, Kala, Choomaka ana ma ke Pihia Komohana, Akau, oia aina a e holo ana, Hem. 30, Nih. 3.08 Kaul. ma ke Lono, alaila, Ak. 64, Nih. 1.70 Kaul. ma ke Kaula, alaila, Ak. 24 1/2, Kom. 207 Kaul. ma ke Kaaea, alaila, Ak. 41 1/2, Kom. 125 Kaulahao ma ke Kanalu, alaila, Hem. 55 1/2, Kom. 160 Kaul. ma ke Aupuni, a hiki i kahi i hoomaka ia, Maia Apana, 665 anana, 2 Akauni, maloko, heia Kuleana,~~

~~Sepatemata 1, 1852~~

~~R. W. Meyer
Surveyor~~

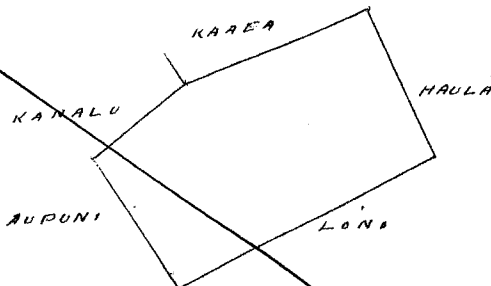
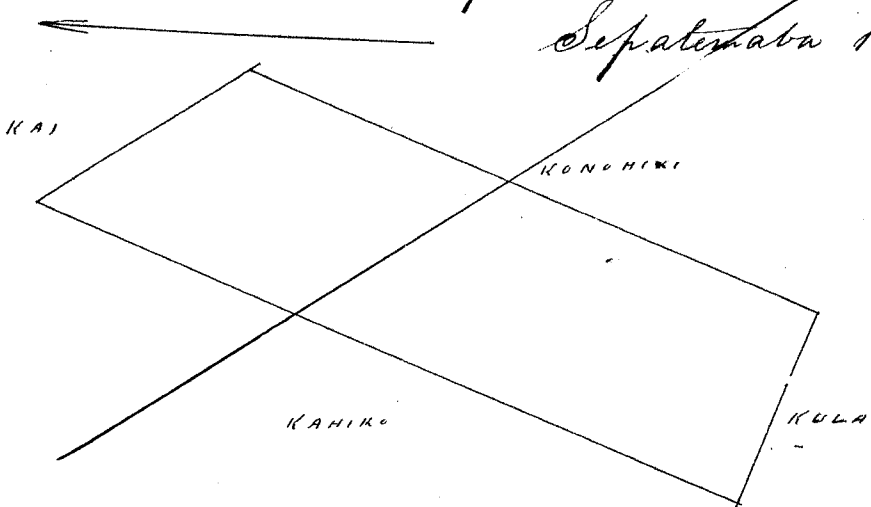

~~Emona awao 582 1/2 v. y. awards.~~

~~Ana/2 in = 1 Kaul.~~

~~Ana/2 in = 1 Kaul.~~

Wku Pau Loa # 7

G. M. Robertson
J. Hekeaulahao
J. H. Smith

Honolulu 13 Oct 1852

Hulu 3902 Napahi

Keawanui & Molokai

Keawanui ili o Kulea Molokai

Apana 1. Choomaka ana ma ke Pihia Komohana iia Lono, a e holo ana, Hem. 29, Nih. 116 Kaul. ma ke Kumu, alaila, Ak. 59 1/2, Nih. 1.92 Kaul. ma ke Loko, alaila, Ak. 35 Kom. 126 Kaul. ma ke Kauakahi, Hem. 56, Kom. 183 Kaul. ma ke Kauakahi, a hiki i kahi i hoomaka ia, maia Apana 275 anana,

Apana 2. Choomaka ana ma ke Pihia Komohana Akau, oia aina a e holo ana, Hem. 17 1/2, Kom. 2.00 Kaul. ma ke Pahupu, alaila, Hem. 18, Nih. 1058 Kaul. ma ke Kekawai, alaila, Ak. 81, Nih. 1.02 Kaul. ma ke Honohiki, alaila, Ak. 44, Kom. 1210 Kaul. ma ke Pali, a hiki i kahi i hoomaka ia, maia Apana, 1 Eka, 565 anana.

Augate 30, 1852

R. W. Meyer
Surveyor

275
1,565
1,840

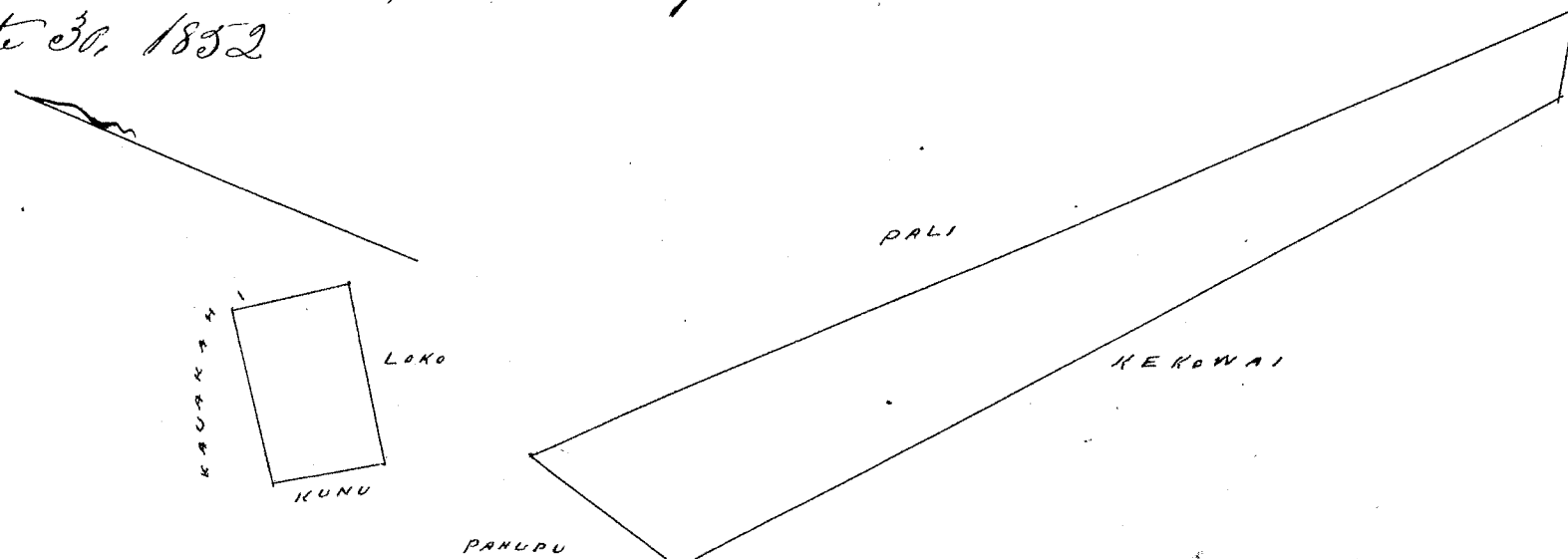

Ana/2 in = 1 Kaul

Wku Pau Loa # 5
W. L. Lee
G. M. Robertson
J. Kaulahao
J. H. Smith

Honolulu 13 Oct 1852.

Helu 4948 Keawanui

Keawanui Molokai.

Keawanui ili... Molokai, E hoomaka ana ma ke Pihikiki Nihina Aka, oia aina a e holo ana, Kom. 20 1/2, Hik. 400 Kaul. ma ke Ohia, alaila, Ak. 82 3/4, Kom. 218 Kaul. ma ke Kekuika, Ak. 85, Kom. 132 Kaul. ma ke Konohiki, alaila, Kom. 74, Kom. 176 Kaul. ma ke Konohiki, Ak. 13 1/4, Kom. 270 Kaul. ma ke Konohiki, alaila, Ak. 77, Hik. 439 Kaul. ma ke Konohiki, a hiki i kahi i hoomaka ia, Maia Apana, 1 Eka 623, anana, Augate 30, 1852,

R. W. Meyer
Surveyor.

1/2 in = 1 Kaul.

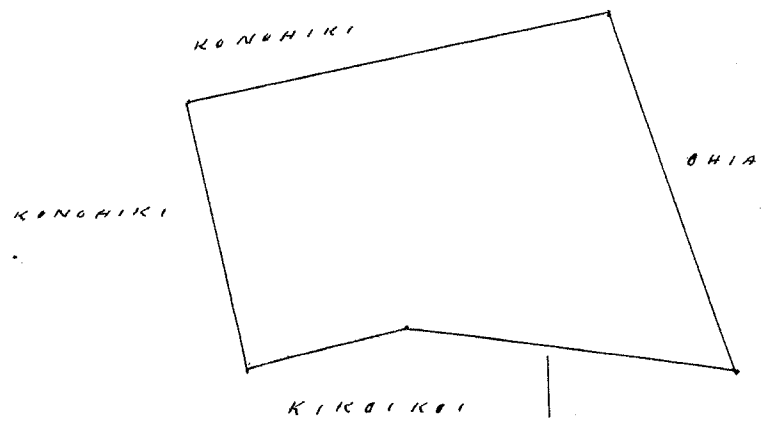

Wku Pau Loa # 5
W. L. Lee
G. M. Robertson
J. Kaulahao
J. H. Smith

Honolulu 13 Oct 1852

Helu 5194 Keili

Ohia Molokai.

~~Ohia ili. Kalalalai, Molokai. Apana 1. E hoomaka ana ma ke Pihikiki Nihina Aka oia aina, a e holo ana, Akau 7 1/2, Kom. 574 Kaul. ma ke Malahia, alaila, Kom. 77, Kom. 111 Kaul. ma ke Alanui, alaila Kom. 20, Hik. 537 Kaul. ma ke Hinan, alaila, Ak. 84 1/2, Hik. 299 Kaul. ma ke Kai, a hiki i kahi i hoomaka ai, maia Apana, 1 Eka, 1113, anana,~~

~~Apana 2, E hoomaka ana ma ke Pihikiki Nihina Aka oia aina, a e holo ana, Ak. 61, Hik. 732 Kaul. ma ke Haalelea, alaila, Ak. 35 1/2, Kom. 812 Kaul. ma ke Konohiki, alaila, Kom. 67 1/4, Kom. 107 Kaul. ma ke Konohiki alaila, Kom. 74, Hik. 896 Kaul. ma ke Keawanui, a hiki i kahi i hoomaka ia, Maia Apana 1 Eka, 907 anana, Augate 30, 1852~~

R. W. Meyer
Surveyor

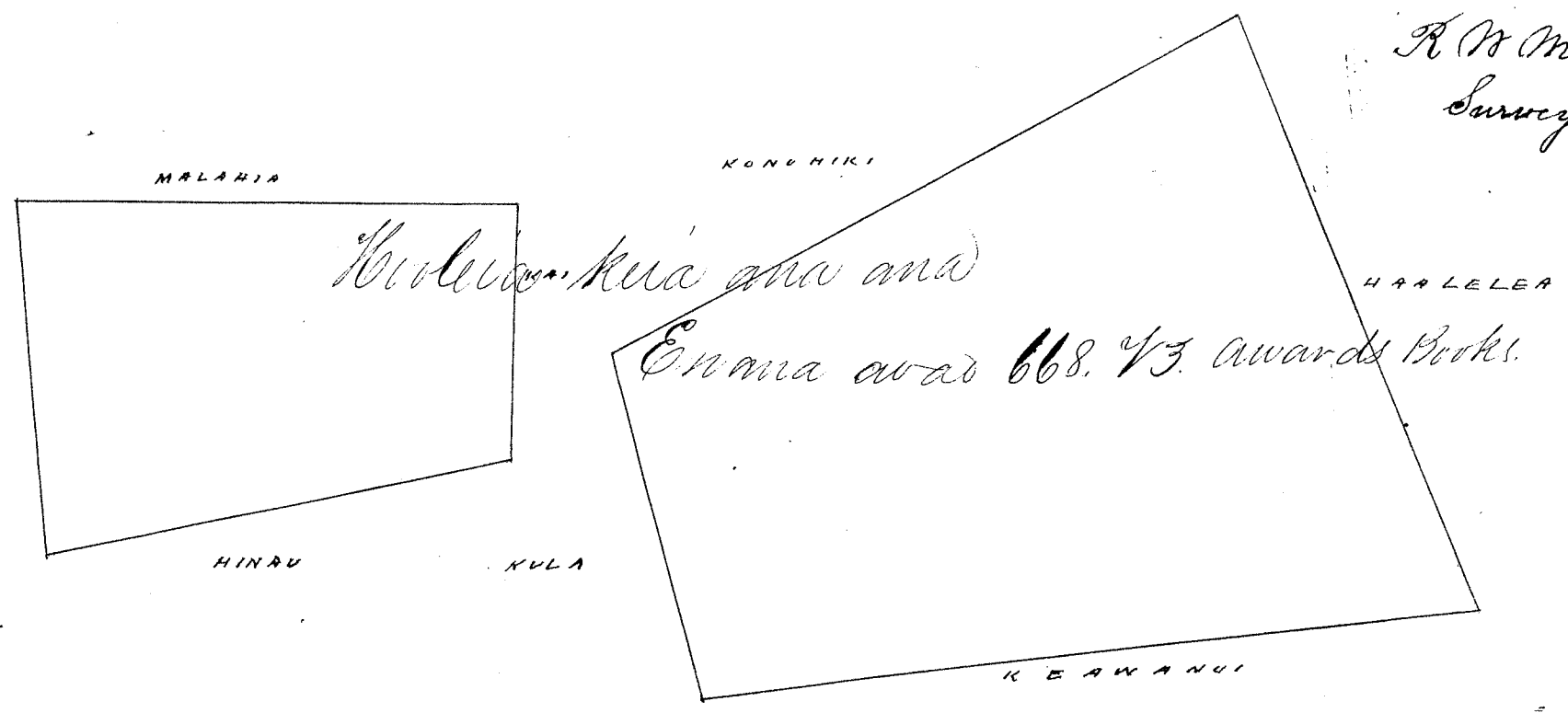

1/2 in = 1 Kaul.

G. M. Robertson
J. Kukaulahas
J. H. Smith

Honolulu 13 Oct 1852.

Kelu 3702 Kekowai 11085. Keawanui Molokai.

Apana 1. Kalo. E hoomaka ana ma ke Pihikina Akau, o keia aina a e holo ana,
Kom. 3' Kom. 100 Kaul. ma ke Kaemalo, alaila, Kom. 17' Kom. 135 Kaul. ma ke Kaemalo, alaila,
Kom. 89' Kom. 370 Kaul. ma ke Ka Loko, alaila, Ak. 5 3/4' Kom. 151 Kaul. ma ke Keanini,
alaila, Ak. 80 1/4' Nih. 4.54 Kaul. ma ke Konoiki, a hiki: kahi: hoomaka ia, ma ia
Apana, 948 anana, 6 Loo, Palima maloke o keia Kuleana,

Apana 2, Kula. E hoomaka ana ma ke Pihikina Nema via aina, a e holo ana, Ak. 55'
Nih. 4.50 Kaul. ma ke Kokoehua, alaila, Ak. 35' Kom. 13.24 Kaul. ma ke Napahi
Pahupu, alaila, Kom. 55 Kom. 200 Kaul. ma ke Konoiki, alaila, Kom. 24' Nih. 13.48
Kaul. ma ke Pali, a hiki: kahi: hoomaka ia, ma ia apana, 4 Eka, 403 anana,
Augate 27, 1852.

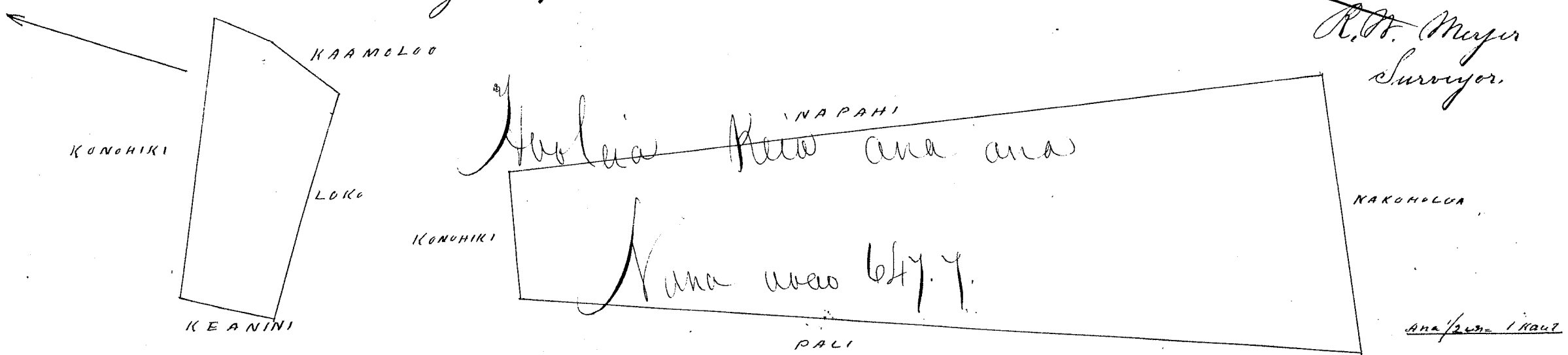

Wm Pau Loa 7

W. L. Lee
G. M. Robertson
J. Kukaulahas
J. H. Smith

Honolulu 13 Oct 1852.

Kelu 4953, Kawenui Waikolu Molokai.

Waikolu ili o Kahalua, Molokai,
Apana 1, Kula. E hoomaka ana ma ke Pihikina Akau, via aina, Kom. 41 3/4' Nih. 4.35
Kaul. ma ke Kai, alaila, Kom. 43 1/2' Kom. 200 Kaul. ma ke Hanaihu, alaila, Ak. 41 3/4'
Kom. 4.35 Kaul. ma ke Kula, Ak. 43 1/2' Nih. 4.00 Kaul. ma ke Kaaea, a hiki: kahi:
& hoomaka ia, ma ia Apana, 8 Eka 871 anana,

Apana 2, Kalo. E hoomaka ana ma ke Pihikina Nema via aina, Kom. 32 1/2' Kom. 0.59
Kaul. ma ke Aupuni, alaila, Ak. 50' Kom. 4.50 Kaul. ma ke Mahanalua, alaila, Ak. 38'
Nih. 4.60 Kaul. ma ke Pali, alaila, Kom. 9' Nih. 6.00 Kaul. ma ke Kahalua, a hiki:
& kahi: hoomaka ia, ma ia Apana, 1 Eka, 172 anana,
Sepatemaba 1, 1852

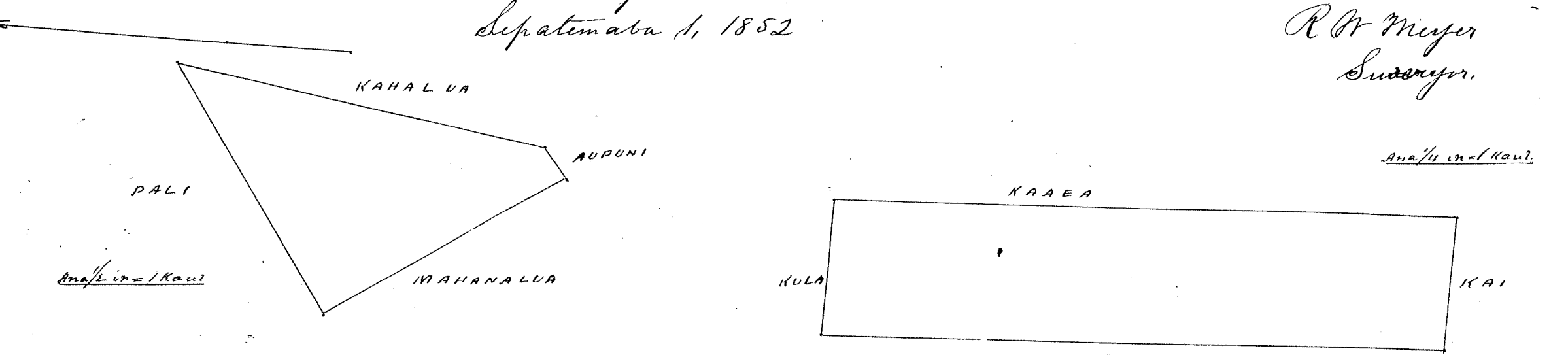

8.871
1.172
9.1043

Uku Pau Lou P
W. L. Lee
G. M. Robertson
J. Kaulahao
J. H. Smith

Honolulu 13 Oct 1852

Hulu 5136 Koaha + 6397 / ^{Maui} Manawai Molokai

~~Apana 1. Pahale, Manawai, ili Kaula Molokai,
Chromataka ana ma ke Pihikoma, Hema, oia aina, a e holo ana, Ak. 6 1/2 Nih. 260 Kaul.
ma ke Paipaitu, alaila, Ak. 12, Nih. 24 1/2 Kaul. ma ke Kaholo, alaila, Ak. 15 Kom.
3.48 Kaul. ma ke Kaholo, alaila, Hem. 30, Kom. 3.00 Kaul. ma ke Aupuni, alaila, Hem.
10 1/2 Nih. 6.00 Kaul. ma ke Kauiki, a hiki: kahi: Chromataka ia, ma ia Apana
1 Eka, 851 anana,~~

~~Apana 2, Loi. Chromataka ana ma ke Pihikoma Akau, oia Loi a e holo ana,
Hem. 25 1/4 Nih. 0.50 Kaul. ma ke Kahuau, alaila Hem. 6 1/2, Kom. 0.66 Kaul. ma ke
Kepano, alaila, Ak. 20, Kom. 0.88 Kaul. ma ke Keaki, alaila, Ak. 65, Nih. 0.62 Kaul.
ma ke Konohiki, a hiki: kahi: Chromataka ia, ma ia Apana, 38 anana.~~

~~Apana 3, Kula. Chromataka ana ma ke Pihikoma Hema, oia aina
a e holo ana, Ak. 6 1/2, Nih. 1.25 Kaul. ma ke Keaki, alaila, Ak. 22, Kom. 1.28 Kaul.
ma ke Konohiki, alaila, Hem. 59 1/2, Kom. 1.40 Kaul. ma ke Nakhohua, alaila Hem. 23 1/2,
Nih. 3.92 Kaul. ma ke Paipaitu, a hiki: kahi: Chromataka ia, ma ia Apana
1 Eka, 934 anana,~~

August 30, 1852

R. W. Meyer
Surveyor

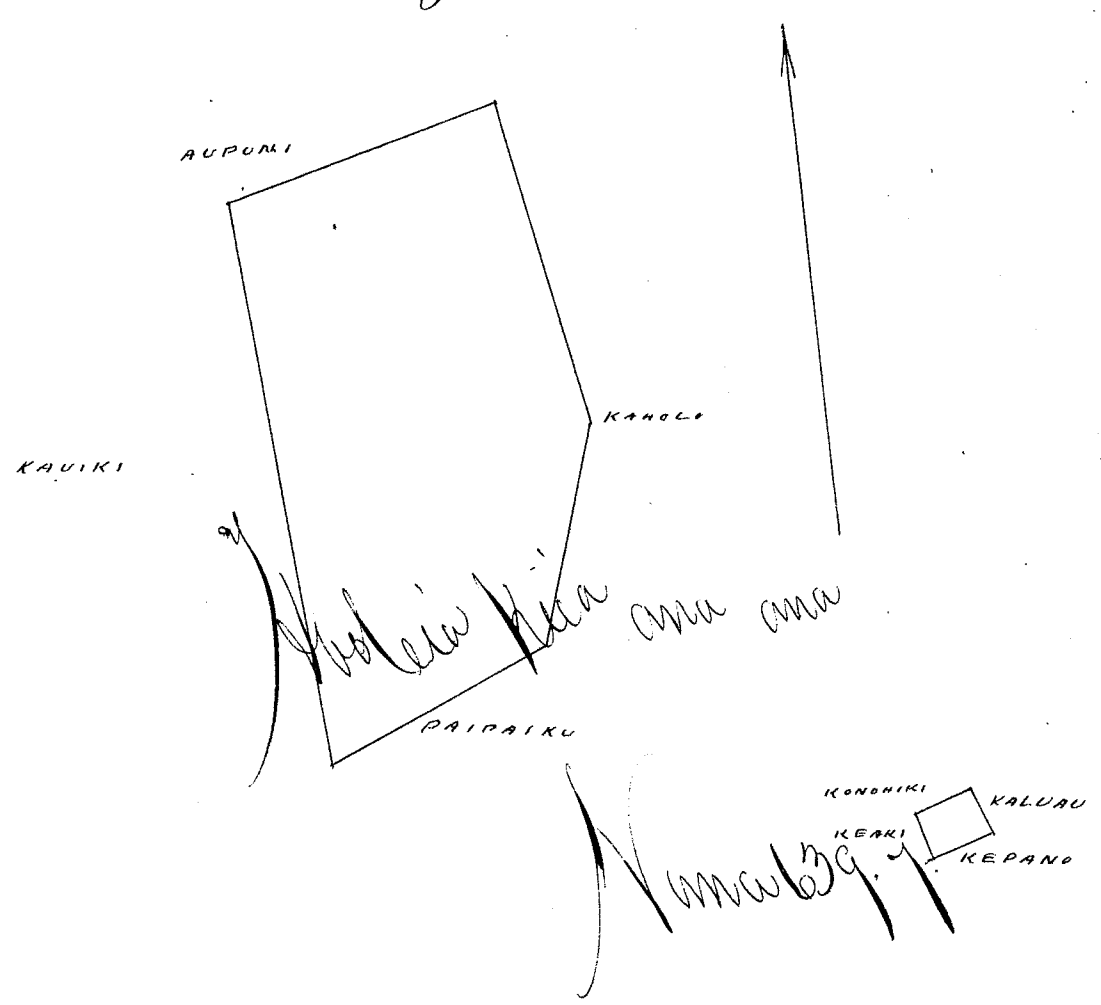

ana 1/2 in = 1 kaul.

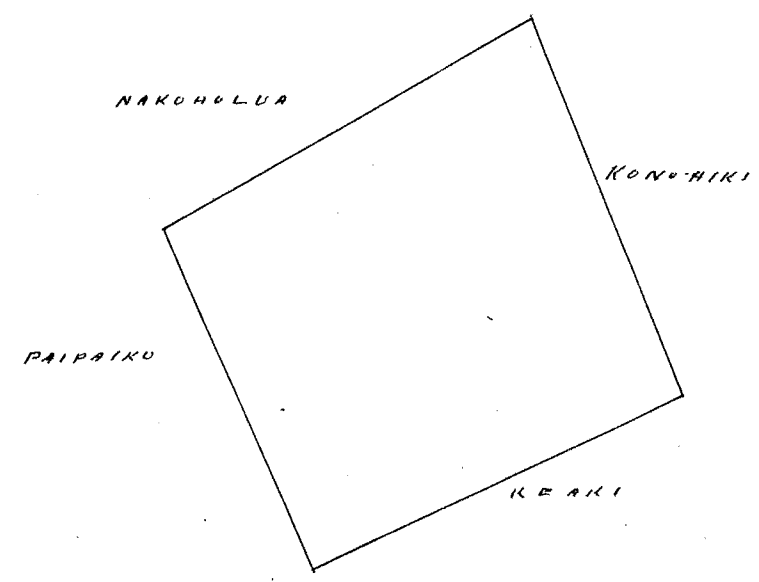

W. L. Lee
G. M. Robertson
J. Kaulahao
J. H. Smith

Honolulu 13 Oct 1852

Walu 4289 Kauhikou + 438 1/2

Waihu Meay.

Apana I Ili. Waialua, E hoomaka Ke ana ona ke Pihī Hema, keia, AK. 4 1/4. Kom. 342. Kaul. ma Ka pali; AK. 65 3/4. Nihē 461 Kaul. ma Ka pali; AK. 60 1/2. Nihē 1,79 Kaul. ma Ka pali; AK. 29 3/4. Nihē 506. Kaul. ma Ka pali; AK. 41. Nihē 655 Kaul. ma Ka pali; Kom. 26 1/2. Kom. 972 Kaul. ma Ka Auwai; Kom. 27 1/2. Kom. 564 Kaul. ma Ka auwai; Kom. 61. Kom. 725 Kaul. ma Ka auwai; a hiki ma Kahi: hoomaka i a malaka via anapuni; 3 1/2 Eka.

Apana II Ili. Waialua, E hoomaka Ke ana ona ke Pihī Konoehana. keia, AK. 3 1/2. Nihē 968 Kaul. ma Ke Kahuwai; Kom. 3. Nihē 11,32 Kaul. ma Ka pali; Kom. 84. Kom. 3,14 Kaul. ma Ke Konoehana; AK. 35 1/2. Kom. 4,25 Kaul. ma Ke Konoehana; a hiki ma Kahi: hoomaka i a malaka via anapuni; 3 65/100 Eka.
Waihu. July 10, 1852.

John S. Gower
Mea ana aina

Olelo houkakei.

Okeia ana ana malama a me ka hooko ana ua hoololi houia a ana houia, a hookoia, aia ka ana pono ma ka Awao 438 Vol. 9.

Decemaba 31, 1853. J. P. Kūteiti
Mea Kakuolelo

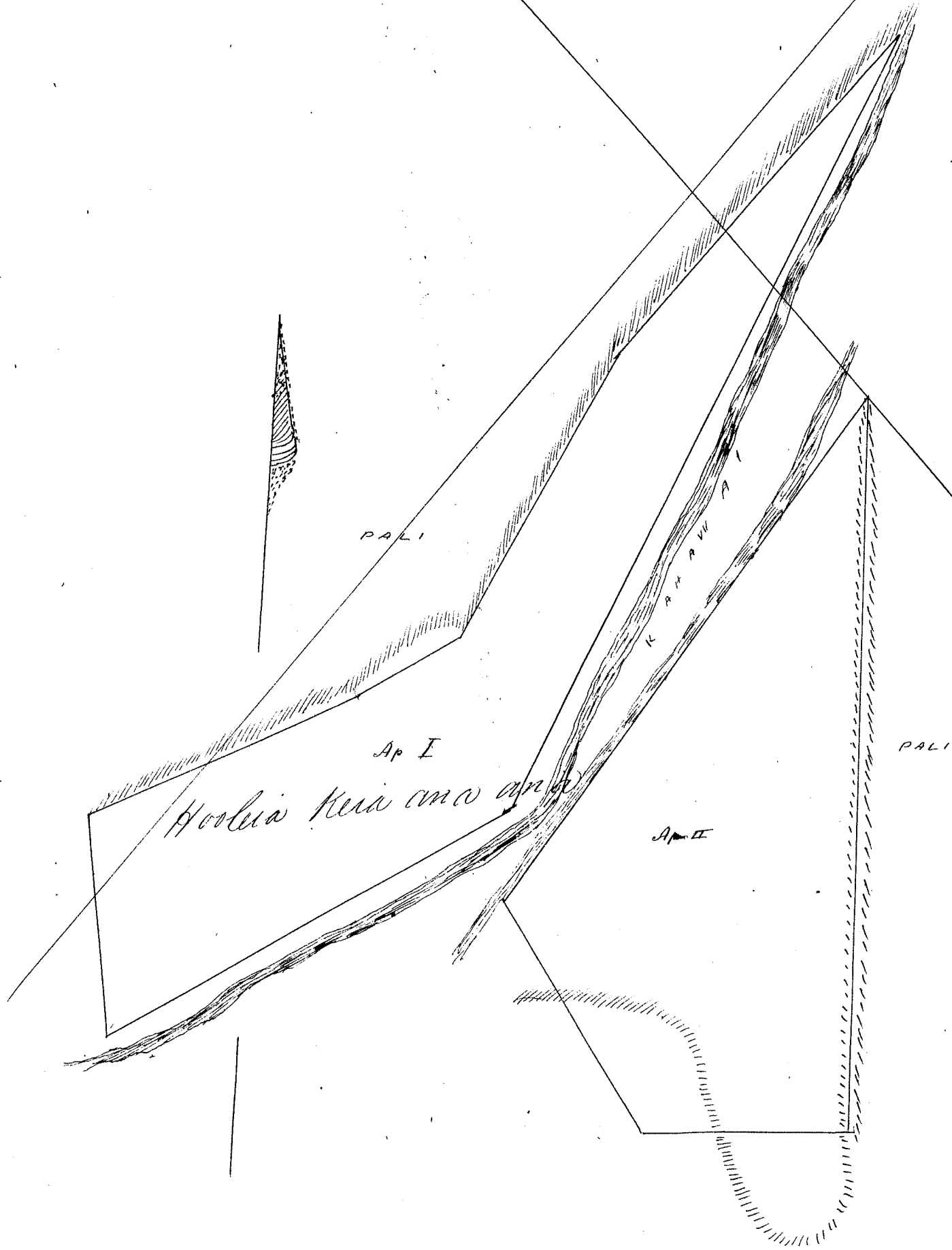

Onana ma Awao 438 Vol. 9
Hooko.

Honolulu 14 Oct 1852

Kolu 3866 Piimaiwaa

Waiver Maui

Apana I Ili. Alau. Chomaka ke ana ma ke Pihī Komohana. heia, Nem. $8\frac{1}{4}$, Nih. 1246
 Kaul. ma ka Auwai, Ak. $8\frac{1}{2}$, Nem. 362 Kaul. ma ke Kuahine, Nem. 82, Nem. 64 Kaul. ma
 ka Pali; Nem. $7\frac{1}{4}$, Nem. 1166 Kaul. ma ka pali; a hiki ma ka hiki; hoomaka'i a maloko
 oia Apana, $2\frac{2}{10}$ Eka,

Apana II Ili. Kalepulepe Chomaka ke ana ma ke Pihī Koma. ke Kahuna,
 Ak. $29\frac{1}{2}$, Nem. 148 Kaul. ma ke Kekahuna, Ak. $89\frac{1}{2}$, Nem. 205 Kaul. ma Kula, Nem. 51;
 Nem. 137 Kaul. ma Kula, Nem. 22, Nem. 442 Kaul. ma Kula, Ak. 79, Nih. 424 Kaul.
 ma ka Pali; a hiki ma ka hiki; hoomaka'i a maloko oia anapuni, $8\frac{1}{100}$ Eka,

Apana III Ili. Kalepulepe, Chomaka ke ana ma ke Pihī Komohana,
 Akihewa, Apana III Ak. 39, Nem. 116, a hiki ma ke Pihī Kikina. heia, Ak. $29\frac{1}{2}$,
 Nem. 116 Kaul. ma ka Paahaa, Nem. $55\frac{1}{2}$, Nem. 50 Kaul. ma ka Poalima, Ak. $33\frac{1}{4}$,
 Nem. 85 Kaul. ma ka Poalima, Ak. 45, Nih. 54 Kaul. ma ka Poalima, Ak. $37\frac{1}{2}$,
 Nem. 120 Kaul. ma ka Paahaa & auwai, Nem. $64\frac{1}{2}$, Nem. 220 Kaul. ma Kula, Nem. 50;
 Nih. 174 Kaul. ma ke Kekahuna, Ak. 62, Nih. 55 Kaul. ma ke Kekahuna, Nem. $10\frac{1}{2}$
 Nih. 220 Kaul. ma ke Kahuna, Ak. $85\frac{1}{2}$, Nih. 150 Kaul. ma ka Pali, Ak. $18\frac{3}{4}$,
 Nem. 89 Kaul. ma ka Poalima, Ak. 60, Nih. 63 Kaul. ma ka Poalima, a hiki
 ma ka pahu mua, a maloko oia anapuni, $5\frac{9}{100}$ Eka,

Apana IV Ili. Puulo, Chomaka ke ana ma ke Pihī Kikina. Kekaula,
 Nem. $77\frac{3}{4}$, Nem. 303 Kaul. ma ke Kekaula, Nem. $66\frac{3}{4}$, Nem. 305 Kaul. ma ka Poalima
 & Maikaloa, Nem. 22, Nih. 128 Kaul. ma ka Poalima, Ak. 62, Nih. 817 Kaul. ma ka
 Konohiki, Ak. $20\frac{3}{4}$, Nem. 95 Kaul. ma ka Loko, a hiki ma ka pahu mua loa, a ma-
 loko oia anapuni, $1\frac{5}{100}$ Eka,

Waiver, July 7, 1852.

John L. Lower.
Ma ana aino,

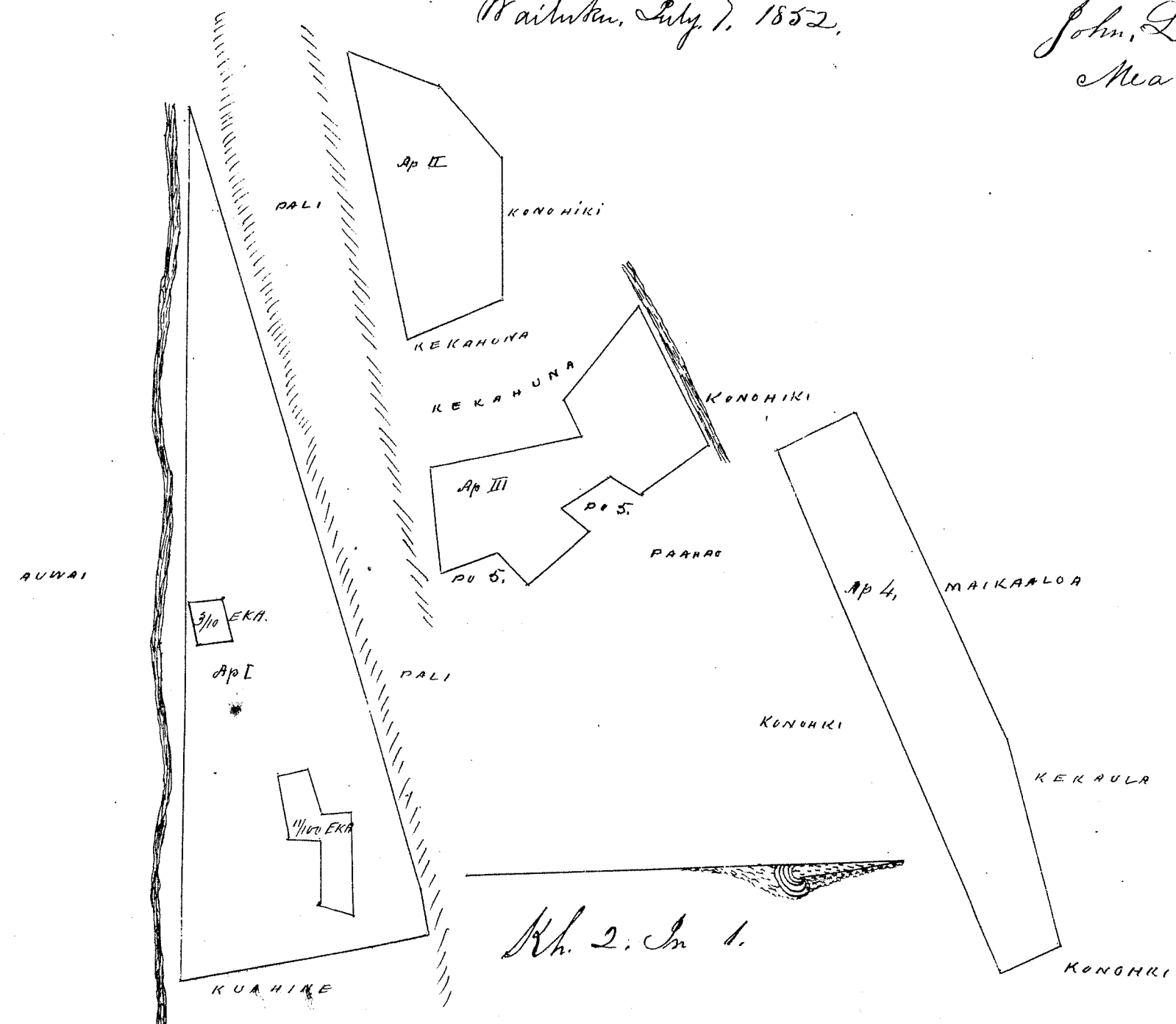

H. L. Lee
J. H. Smith
J. Kekaulahao
G. M. Robertson

Honolulu 14 Oct 1852.

Helu 19⁵/₆ Kapaula. () Punaluu me Waiape Kauhoe Oahu

3 Lōi me ke Kauhahale, ma Punaluu me Waiape, Kauhoe Oahu. - Chomaka ma ke Pihī Akau, makai o keia, pili ana me ke Pihī Hema, ma kai o ke Mākea aina, a e holo ana ma ke Kula. Waiape, Hem. 17° Nīk 276 Kaul. - Hem. 56° 30' Nīk 127 Kaul. - a Hem. 72° 15' Nīk 170 Kaul. a hiki i ke Peha Kauhahale, alaila ma ke Peha, Hem. 10° 30' Nīk 88 pautu, a AK. 54° 45' Nīk 350 Kaul. a hiki i ke Kumuhoona Kahua, alaila, Hem. 31° 30' Nīk 155 Kaul. ma ke Kumuhoona, alaila Hem. 28° 30' Nīk 330 Kaul. ma ke Kuluhoona Kahua, a hiki i ka hau nui, ma ke Pihī Hema makai o keia, alaila, Hem 63° 75' Kom. 133 Kaul. ma ke Kula. Waikalua, a hiki i ka pa lipo, - alaila ma ia pa, AK. 62° 15' Kom. 134 Kaul. AK. 77° 45' Kom. 257 Kaul. AK. 58° 45' Kom. 149 Kaul. - alaila AK. 51° 15' Kom 84 pautu, a hiki i ke Pihī o ka Lōi. Paekane, - alaila AK. 74° 45' Kom. 166 Kaul. ma ke Paekane a me ke Kumuhoona, a hiki i ke Opu, alaila, AK. 36° Kom. 212 Kaul. ma ke Opu a me ke Peha, alaila, AK. 24° 15' Kom. 130 Kaul. ma ke Peha, a hiki i ke Mākea aina, alaila ma ke Mākea, AK. 13° 30' Kom 110 Kaul. - a AK. 69° Nīk 161 Kaul. a hiki i ka hiki i hoomaka ai, Ma ia Apana, 2 ⁵/₁₀₀ Eka.

2 Lōi, ma Waiape, Chomaka ma ke Pihī Akau o keia, makai, e pili ana me ke Lōi. Poalima, a me ke Pihī o ke Peha, lōi, - a e holo ana, Hem. 5° Nīk 244 Kaul. ma ke Kula. Waiape, - alaila, Hem. 78° 45' Kom. 84 pautu a hiki i ke Kahawai, alaila pili ana ma ke Kahawai, 284 Kaul. a hiki i ka Lōi Poalima, alaila AK. 82, Nīk 117 Kaul. ma ka Poalima, a hiki i ka hiki i hoomaka ai, ma ia Apana, 26 ¹/₁₀₀ Eka, 3.19 anana.

A. G. Thurston
Sur.

June 17, 1852

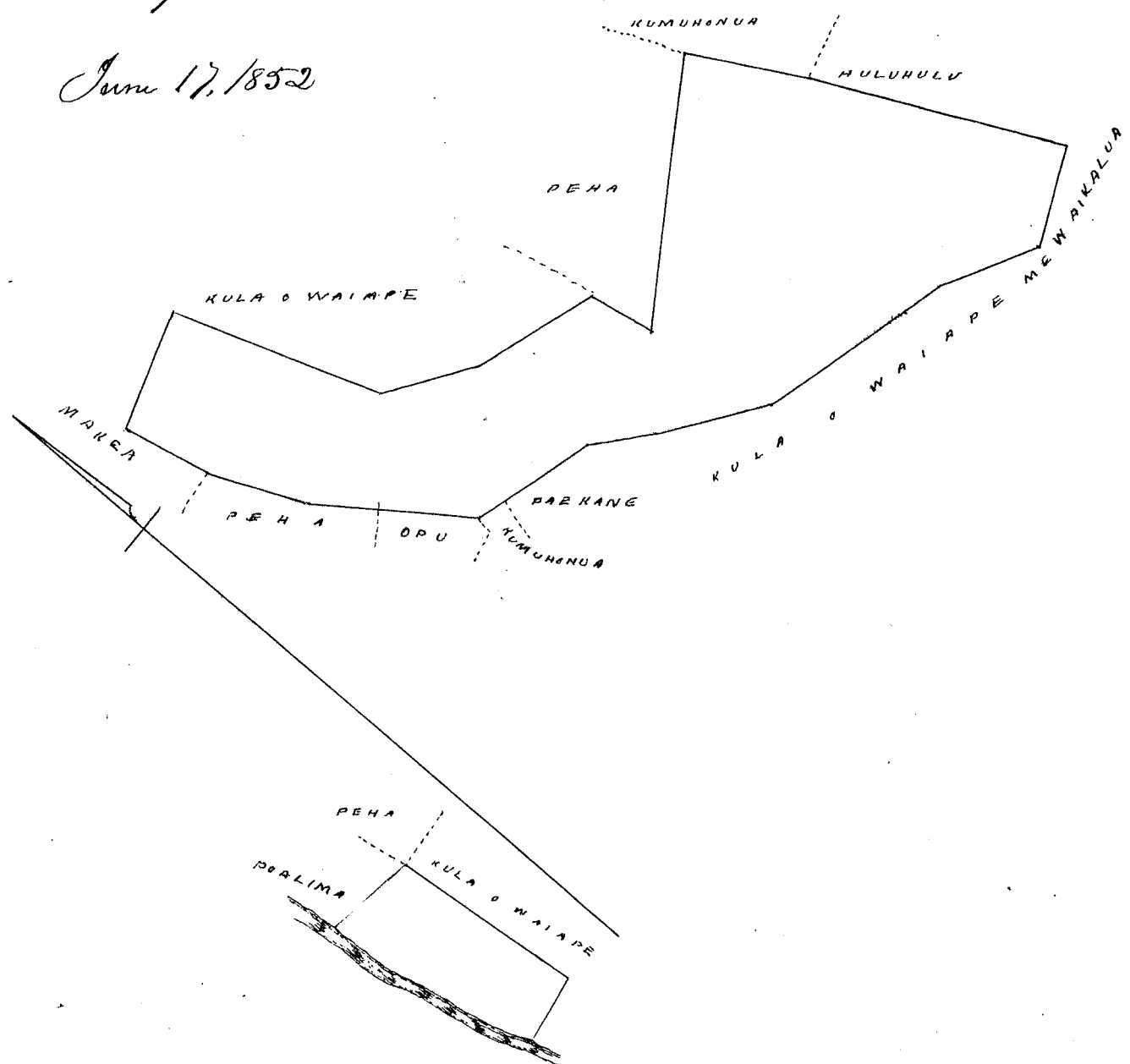

Uku Pau Loa # 6
H. L. Lee
G. M. Robertson
J. H. Smith

Honolulu, 15, Oct, 1852.

J. Kekaulahao

Hele 3720 Makainu

Kapaka Pahu

11 Poi Kula, o Pahale, Chomaka ana ma ke Pihia Akau, a e holo ana, Hem. 36° Nih 114 pautu, e pili ana i ke Konoiki, Hem. 57° Kom. 350 pautu, e pili ana me ke Kaamakea, Hem. 75° Kom. 324 pautu, e pili ana i ke Konoiki, Hem. 61° Kom. 800 Pautu, e pili ana me Konoiki, Ak. 56° Kom. 287 pautu, e pili ana me Konoiki, Ak. 53° Nih 190 Pautu, e pili ana i ke Konoiki, Ak. 64° Kom. 435 Pautu, e pili ana i ke Napahule, Ak. 48 Kom. 170 pautu, e pili ana me ke Napahule, a hiki i kahi hoomaka ia $4 \frac{2}{3}$ Eka

A. F. Turner.
Luna ana aina.

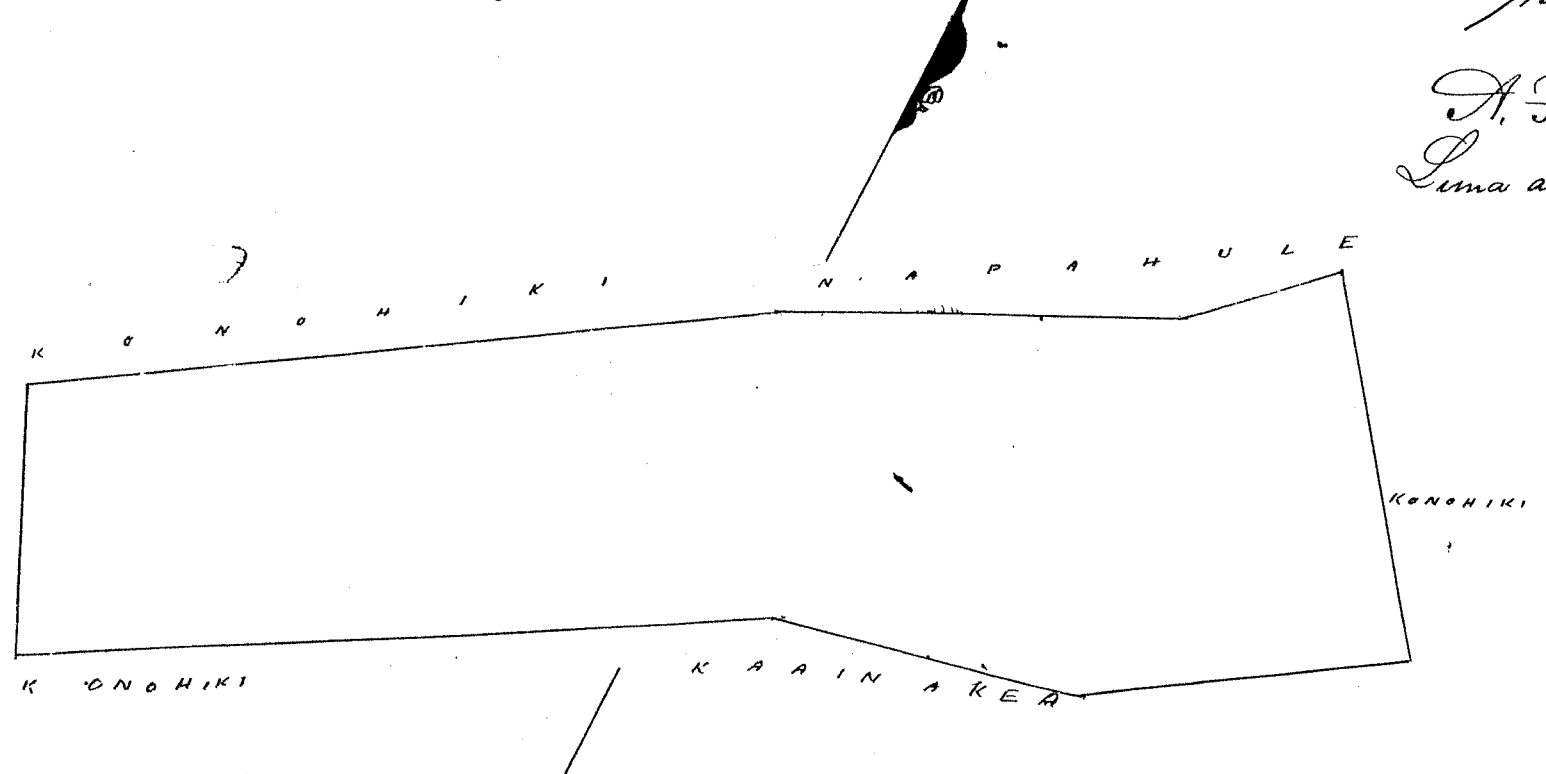

Ulu Pau Loa # 7
M. L. Lee
G. M. Robertson
S. Takaulaha
J. H. Smith

Concluded 13 Oct 1852

Hele 8146 E Nailiha

Makana K.L. Oahu

Apana 1. 4 Poi. Chomaka ana ma ke Pihia Akau, a e holo ana, Hem. 57 1/2° Nih. 360 pautu, e pili ana i ke Kaauku, Hem. 46 1/2° Kom. 236 pautu, e pili ana i ke Konoiki, Hem. 28° Nih. 40 pautu, e pili ana i ke Konoiki, Hem. 53 1/2° Kom. 180 pautu, e pili ana i ke Konoiki, Hem. 6° Nih. 100 pautu, e pili ana i ke Konoiki, Ak. 61 Kom. 26 pautu e pili ana me Kaau, Ak. 44° Kom. 350 pautu e pili ana me Kunoamalana, Ak. 57° Nih 108 pautu, e pili ana me Konoiki, Ak. 34° Kom. 133 P. autu, e pili ana i ke Konoiki, Ak. 43° Nih 164 Pautu, e pili ana me ka auwai, a hiki i kahi hoomaka ia $1 \frac{1}{4}$ Eka,

A ma Kula me Pahale, Chomaka ana ma ke Pihia Akau a e holo ana Hem. 76° Nih 270 pautu, alana i aupuni, Hem. 4° Kom. 140 pautu Konoiki, Ak. 83° Kom 300 pautu ma Konoiki, Ak. 5 1/2° Nih 1100 pautu Konoiki, i ke Pihia ma $3 \frac{2}{3}$ Eka

A. F. Turner.
Luna ana aina.

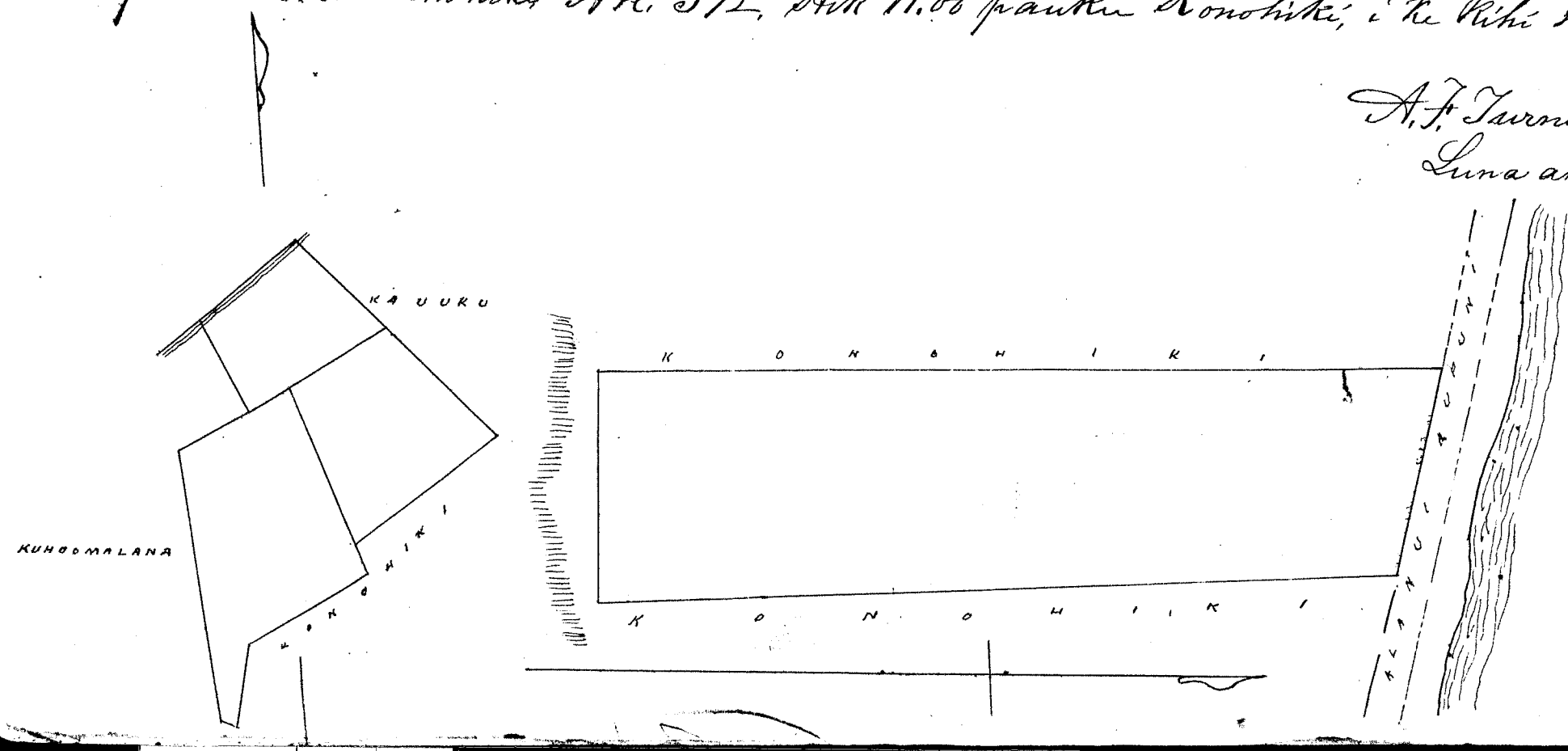

174
302
476

Uku Pau Loa \$5

267

W. L. Lee
G. M. Robertson
J. Kekaulahao
J. H. Smith

Honolulu 15 Oct 1852.

Heleu 4266. Kalawala

Waiākea Oahu

Mai Awar 442. 1/6.

Apana 1. 1 Loi, E hoomaka ana ma ke Pihī Akau, a e holo ana, Hem. 34^{1/2} Ki 385
pauku, e pili ana i ke Keliikui alaila Hem. 64. Hem. 114 pauku, e pili ana i ke Konoiki alaila
Ak. 35. Hem. 393 pauku, alaila Ak. 85. Nīk 122 pauku, e pili ana i ke Kāhawai, a hiki i
Kahi i hoomaka i \$4/100 Eka.

Apana 2, Pahale. E hoomaka ana ma ke Pihī Nuna, a e holo ana, Ak. 25. Hem.
125 pauku, alaila, Ak. 67. Nīk. 117 pauku, alaila, e pili ana i ka^{pa} pohaku, alaila, Hem.
25. Nīk 126 pauku, e pili ana i ke Konoiki alaila Hem. 58. Hem. 142 pauku e pili i ka
pa pohaku, a hiki i Kahi i hoomaka i 15/100 Eka.

A. F. Turner,
Luna ana aia,

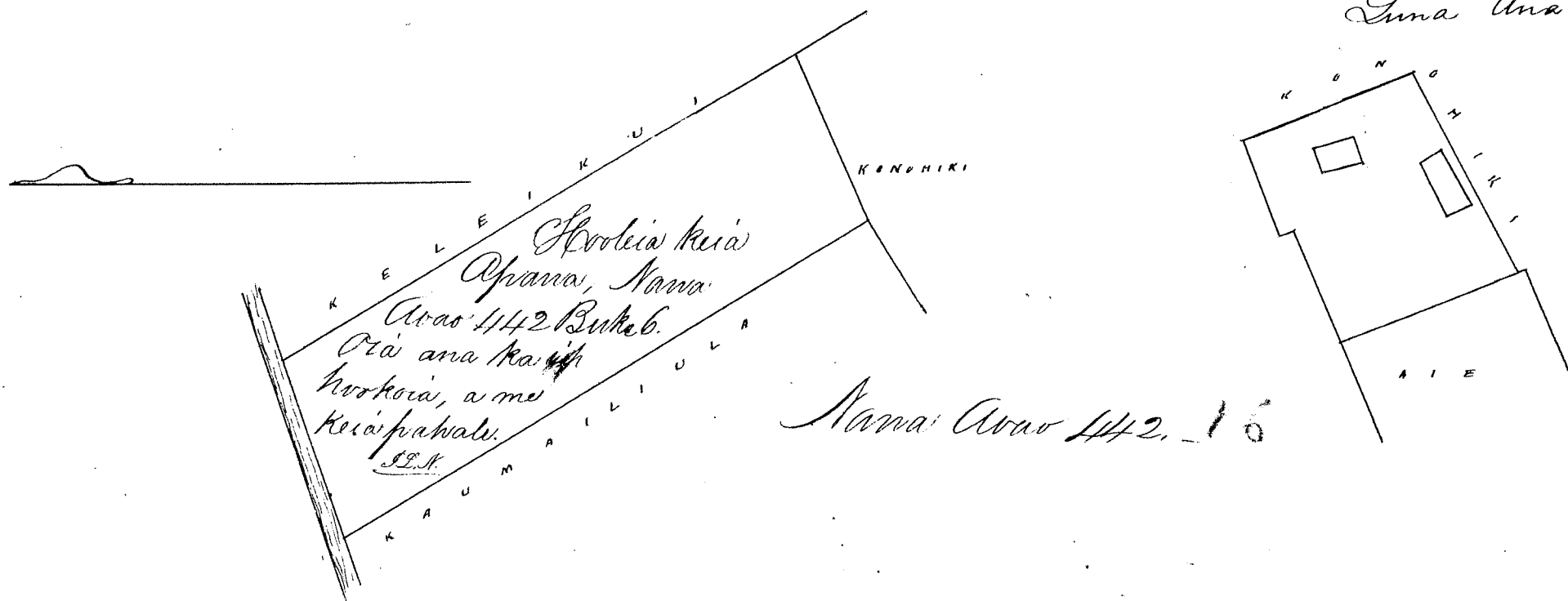

Uku Pau Loa \$4

W. L. Lee
G. M. Robertson
J. Kekaulahao
J. H. Smith

Honolulu 15 Oct 1852.

Heleu 4431. Kaumaka

Waialeale Maui

Apana II Ili Nalinamaia, E hoomaka ke ana ma ke Pihī Komoana, e pili ana i
ke Pihī Nuna i Kūholoaulane, Ak. 62. Nīk. 118 Kaul. ma Kūholoaulane, Hem. 43^{1/2}.
Nīk. 77 Kaul. ma Kūholoaulane. Hem. 57. Hem. 23 Kaul. ma Keawe, Hem. 77^{1/2} Hem. 94
ma Kaulua, Ak. 55. Hem. 64 Kaul. ma Kaulua, a hiki ma Kahi i hoomaka i
a onaloke oia anapuni, 8/100 Eka,

Apana I Wa haalele oia,
Wailuku, Aug. 12, 1852

John S. Loring
Mea ana aia

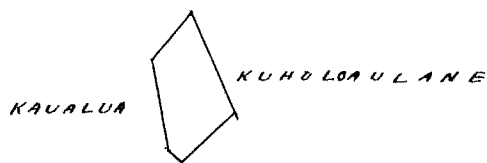

Kh. 2, In 1.

Uku Pau Loa # 4

W. L. Lee
G. M. Robertson
J. Kekaulahao
J. H. Smith

Honolulu 14. Oct. 1852.

Heleu 3690^B Waikane

Honolulu aina Oahu

4 Loi ai, 7 Loi Kame nala. Okahmahale, ma Kaakopua, Honolulu aina,
E hoomaka ana ma ke Kahi Kema, - a i holo ana, Ak. 65. Hik. 100 pautu, e pili ana i ka pa,
Ak. 71. Hik. 148 pautu e pili ana i ka pa. Ak. 30 Kom. 82 pautu, e pili ana i ko Aihuan
Ak. 51. Hik. 51 pautu e pili ana i ko Aihuan, Ak. 3 1/2 Kom. 52 pautu, e pili ana i
ko Aihuan, Ak. 51. Hik. 118 pautu, e pili ana i ko Aihuan, Ak. 43. Kom. 135 pautu
ma ke Makalawelawe, Kom. 45. Kom. 158 Pautu, e pili ana me Konaialee, Ak. 4 1/2
Kom. 95 pautu, e pili ana me Konaialee, Kom 1 1/2 Kom 123 pautu, e pili ana me
Kalua, Ak. 4 2/4 Kom. 25, pautu, e pili ana ia Kalua Kom. 49. Kom. 101 pautu, e
pili ana me Konoiki, Kom. 38, Hik. 340 pautu, e pili ana me Kelihihema, a hiki i
Kahi i hoomaka i 1 1/2 Eka,

Honolulu. 24. May 1851.

A. F. Turner
Luna ana aina

Aloloakaka

Ua hookeia ke keia Huleana malalo iho o ke Aro Alodio, a he hapaha ko ke Aupuni Kulanu iho.
E hiki no ma iia ke hoolilo ae ma ke Aro Alodio ke ahu aku oia iho ke Aupuni hapaha, Alaila
ma hupuna iia ke Palapala Sila Alodio.

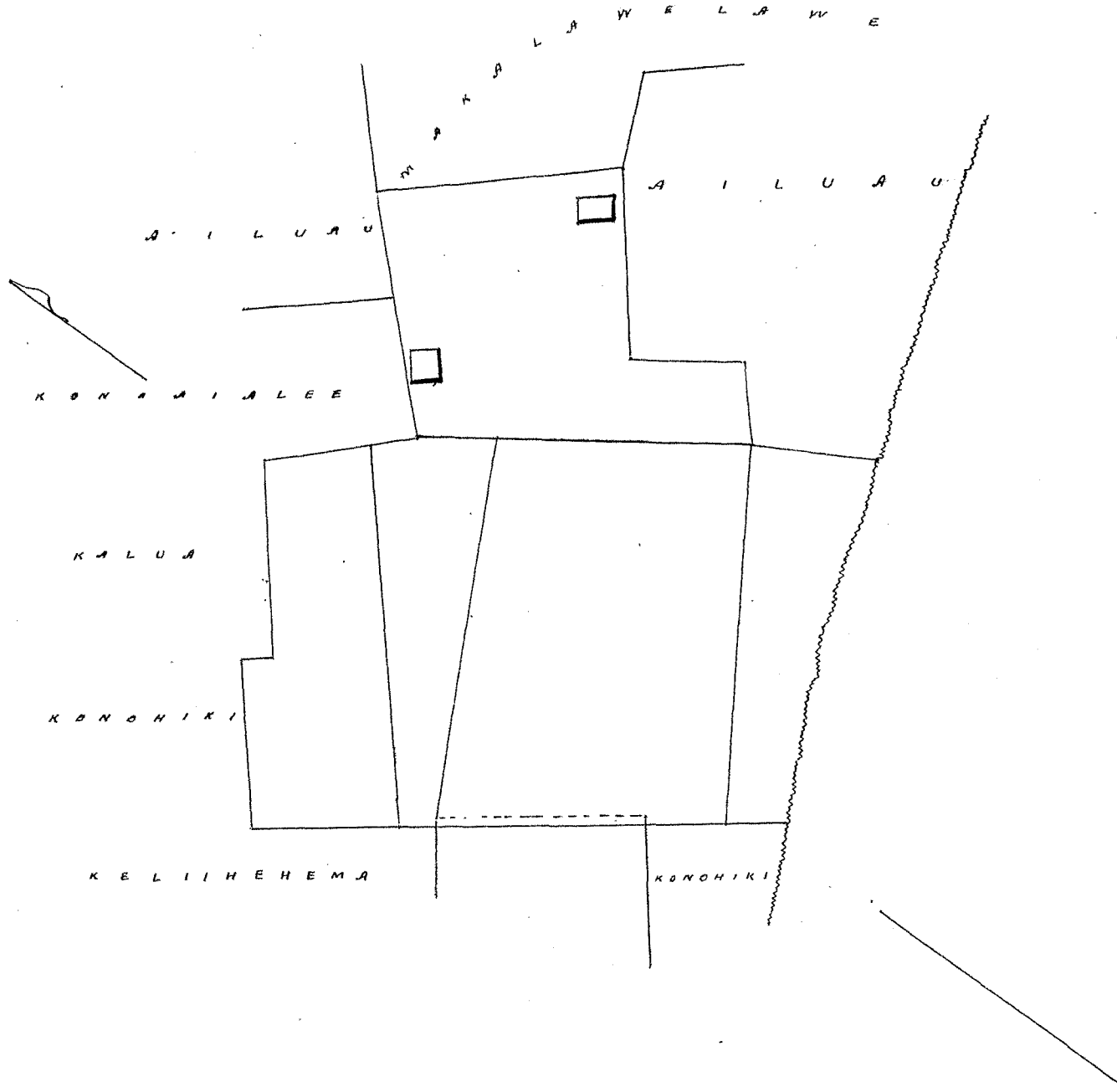

Uku Pau Loa # 10

Pau loa \$ 8.00

G. M. Robertson
W. L. Lee
J. Kekaulahao
J. H. Smith

Honolulu 16. Oct. 1852.

5575

Apama I Ili Kapoheua. Chromaka he ana ma ke kiki Hikina, i pili ana ke Kae. Nem. 73 1/2. Kom. 73 1/2 Kaulahao, ma Kula, Ak. 10. Hik. 568 Kaulahao, ma Paa, Ak. 72 1/2. Hik. 160 Kaulahao, ma Kula. Kom. 19. Hik. 497 Kaulahao, ma Paa, a hiki ma ka pahu mua, maloko oia anapuni, 3 29/100 Eka.

Apama III Ili Koiaki. Chromaka he ana ma ke kiki Akau, o Kihulamotu, ke kiki Ke mohana, Kua, Ak. 41. Hik. 583 Kaulahao, ma ka auwai, Ak. 81 3/4. Hik. 250 Kaulahao, ma ka auwai. Nem. 25 1/4. Hik. 46 Kaulahao, ma ke Paiki Ak. 58. Hik. 97. Kaulahao, ma Paiki, Nem. 35 1/2. Hik. 45 Kh. ma Paiki, Ak. 56 1/4. Hik. 124 Kh. ma Paiki, Nem. 39 1/4. Hik. 93 Kh. ma Paikas, Nem. 66 1/4. Kom. 129 Kaul. ma Poalima o Kauakahi, Ak. 27 1/4. Kom. 71 Kaul. ma Poalima o Kauakahi, Nem. 55 1/4. Kom. 121 Kh. ma Poalima o Kauakahi, Nem. 32 1/2. Hik. 66 Kh. ma Poalima o Kauakahi, Nem. 58. Kom. 73 Kh. ma Kauakahi, Nem. 17 1/2. Hik. 53 Kaul. ma Kauakahi, Nem. 57 1/4. Kom. 74 Kaul. ma Kauakahi, Ak. 24 3/4. Kom. 78 Kaul. ma Kauakahi, Nem. 63 3/4. Kom. 98 Kh. ma Poalima, Ak. 25. Kom. 60 Kaul. ma Poalima, Nem. 67 1/2. Kom. 57 Kaul. ma Poalima, Nem. 22 1/2. Hik. 123 Kaul. ma Poalima, Nem. 67. Kom. 318 Kaul. ma Kapihue, Nem. 82. Kom. 166. Kaul. ma Alauka, a hiki ma Kahi i Chromaka i a maloko oia anapuni, 1 34/100 Eka.

Waikuu, 7. July, 1852

John S. Sower

Ma ana aina

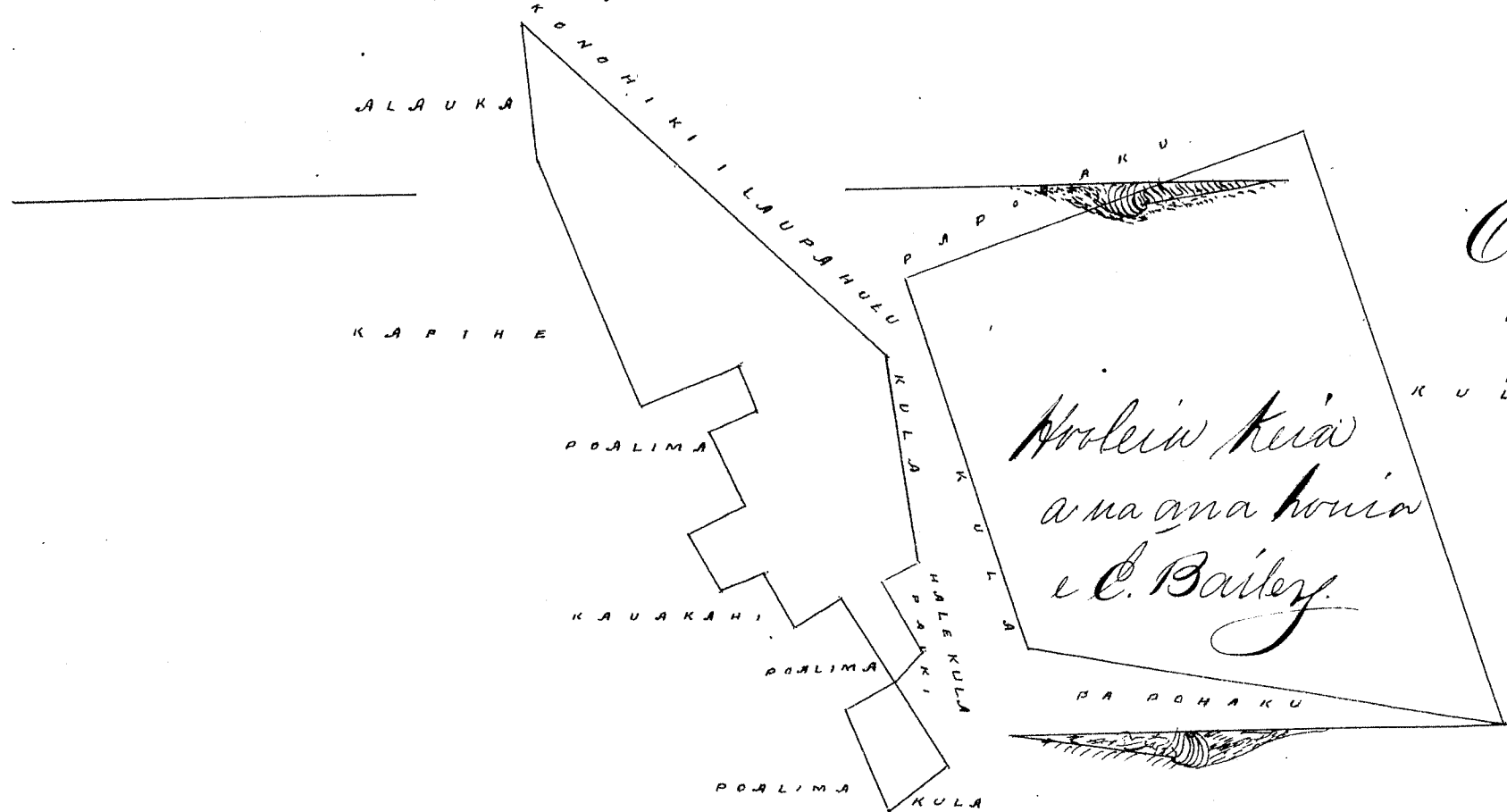

Olelohwakaka. O ke ana ana a John S. Sower i ka apama 1. i ka ana ma Kua Burke, ma holeia, ana ana honia e C. Bailey, oia ana a C. Bailey ka pua. a ma holeia ma ka awa 189. Burke 3. hoko, o kala i hokoia i ma Kua Burke, oia ma kala i hokoia i ma ka Burke 3. i ka ana malama.

Augate 7. 1854.

C. Kamau, me ka kaula

Uku Pau Loa 13.00

M. L. Lee
G. M. Robertson
J. Sekaulahao
J. H. Smith

Honolulu, 14. Oct. 1852

Heleu 2246 E Palu

K. I. O. Kealahou Oahu

19 Loi, Kula o Pahale. Chromaka ana ma ke kiki Nema Kom. a e holo. Nem. 83. Hik. 100 pauka, ma Komohiki, Ak. 2 1/2. Hik. 194 pauka, ma Komohiki, Ak. 63 1/2. Hik. 388 pauka, ma Komohiki, Ak. 5. Kom. 224 pauka, ma Komohiki, Ak. 59. Kom. 420, pauka, ma Kaa, ma ke Kahawai; alaila i pili ana i ke Kahawai, i ke kiki mua, 19/100 Eka.

21. Nov. 1852.

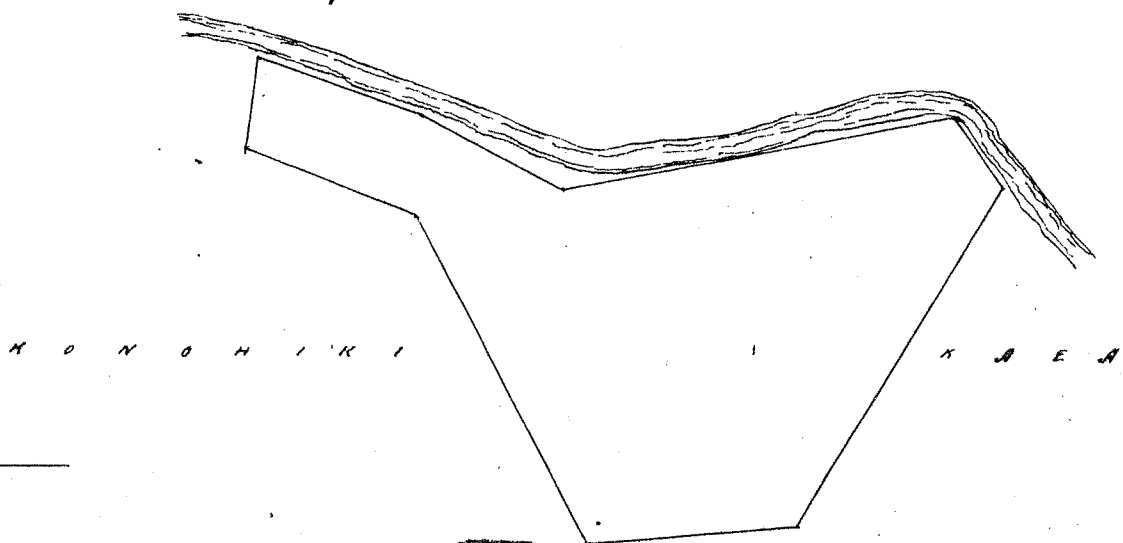

A. F. Turner.
Ma ana aina

W. K. Lu
G. M. Robertson
J. Kekaulahao
J. H. Smith

Honolulu 16 Oct 1852

Heleu 2246^F Kaliliha Kahaluu Oahu

Apana 1. Kahalahale, E hoomaka ana ma ke kahi Ak. a e holo, Hem. 52 1/2, Kom. 250 pautu, ma Konoehiki, Hem. 35, Hik. 350 pautu, ma Konoehiki, Ak. 34, Hik. 310 pautu, ma Konoehiki, Ak. 45, Kom. 251 pautu, ma Konoehiki, i ke kahi ma, 8/10 Eka.

Apana 2, 4 Loi, E hoomaka ana ma ke kahi Ak. a e holo ana, Hem. 52, Kom. 325 pautu, ma Konoehiki, Hem. 32, Kom. 240 pautu, ma Konoehiki, Hem. 50 Hik. 210 pautu, ma Konoehiki, Ak. 37, Hik. 35 pautu, ma Konoehiki, Hem. 40, Hik. 105 pautu, ma Konoehiki, Hem. 39, Kom. 444 pautu, ma Kahawai, Ak. 53, Kom. 4, 78 pautu ma Konoehiki, Ak. 23, Hik. 2, 10 pautu, ma Konoehiki, Ak. 8, Hik. 196 pautu, ma Konoehiki, i ke kahi ma, 1 1/10 Eka,
19 Nov 1852,

A. F. Turner,
Luna ana aina.

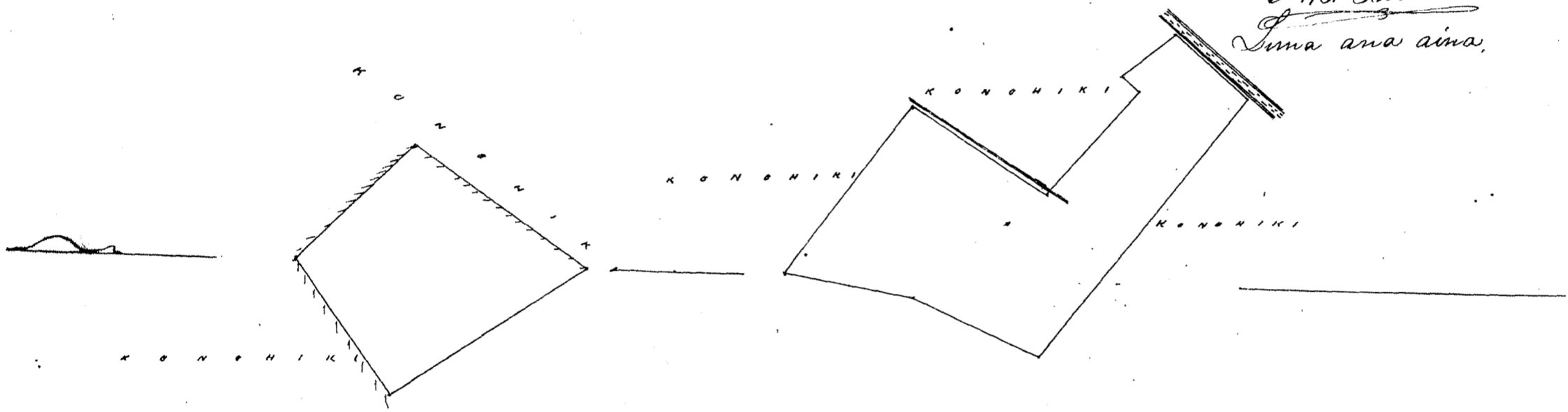

W. K. Lu
G. M. Robertson
J. Kekaulahao
J. H. Smith

Honolulu 16 Oct 1852

Heleu 2246^C Koaia Kahaluu Oahu

Apana 1. 6 Loi, E hoomaka ana ma ke kahi Ak. a e holo ana, Hem. 61, Hik. 300 pautu, ma Keope, Hem. 27, Kom. 264 pautu ma Konoehiki, Ak. 59, Kom. 4, 20 ma Palu, Ak. 51, Hik. 285 ma Kahawai, i ke kahi ma, 1 Eka.

Apana 2, 1 Loi, Kahalahale, E hoomaka ana ma ke kahi Akau, a e holo, Hem. 60, Kom. 380 pautu, ma Konoehiki, Hem. 3 Hik. 220 pautu, ma Konoehiki, Hem. 86, Hik. 550 pautu, ma Konoehiki, Ak. 4, Kom. 4, 30 pautu ma Konoehiki, i ke kahi ma, 1 Eka,
28, Nov, 1852,

A. F. Turner
Luna ana aina

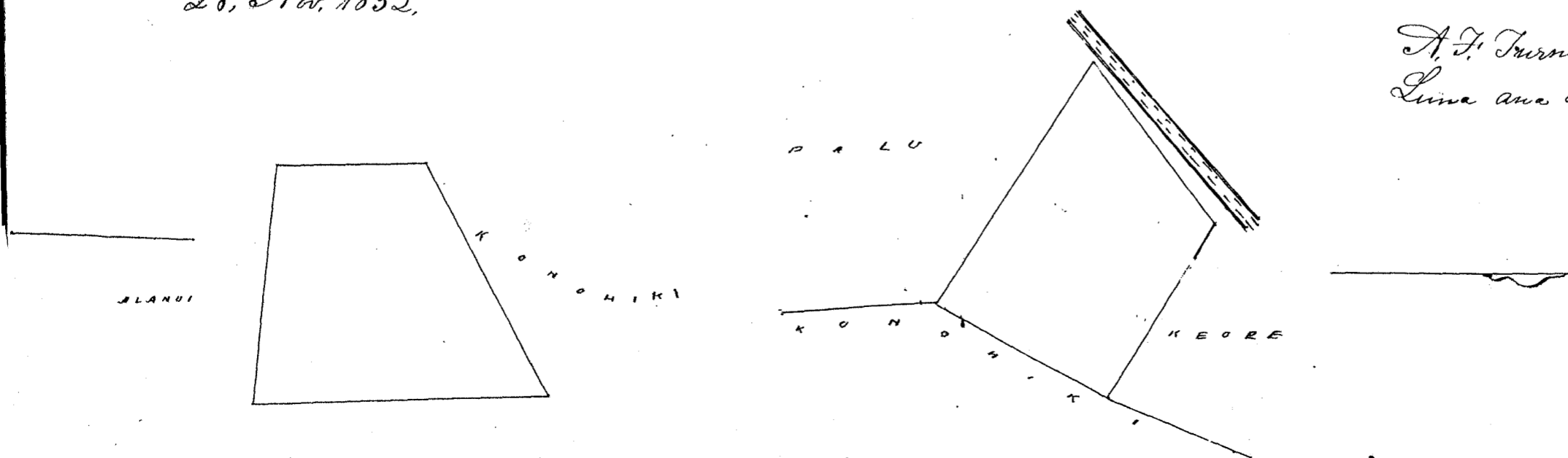

Wku Pau Loa \$ 6

271

W. L. Lee
G. M. Robertson
J. Kaulahao
J. H. Smith

Honolulu 16 Oct 1852.

Helu 2246 Kapule.

Kahalaun Oahu

Apawa 1. 1 Loi. E hoomaka ana ma ke kahi Kama, a e holo ana, AK. 27° Kom. 140 pautu, ma Kaniko, AK. 53° Nih. 63 pautu, ma Mahoe, Kom. 26 1/2° Nih. 150 pautu, ma Mahoe, Kom. 63° Kom. 58 pautu ma Ioba, i ke kahi mua, 8/100 Eka.

Apawa 2. 1 Loi. E hoomaka ana ma ke kahi Kama, a e holo, AK. 38° Kom. 110 pautu ma Konohiki, AK. 44° Nih. 106 pautu ma Konohiki, Kom. 47° Nih. 119 pautu, ma Konohiki, Kom. 48° Kom. 126 pautu, ma Konohiki, i ke kahi mua, 13/100 Eka.

Apawa 3. Kahuahale. E hoomaka ana ma ke kahi Akau, a e holo ana, Kom. 68° Kom. 175 pautu, ma Ioba, Kom. 31° Nih. 340 pautu ma Konohiki, AK. 68° Nih. 140 pautu, ma Konohiki, alaila e pili ana i ke Kahakai, i ke kahi mua 53/100 Eka.

A. F. Turner
Luna ana aine

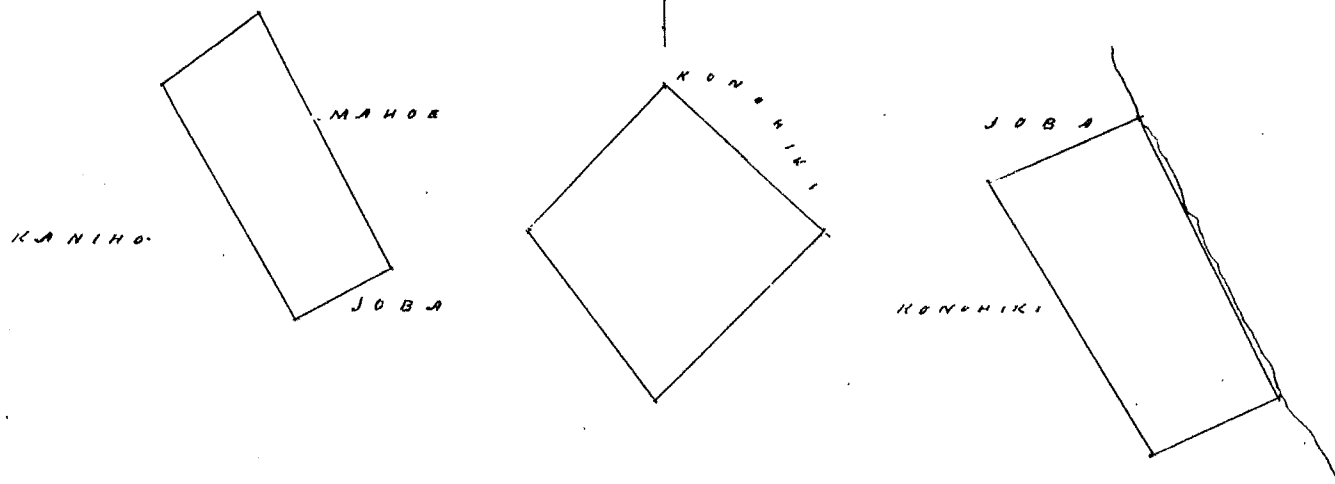

Wku Pau Loa \$ 4

W. L. Lee
G. M. Robertson
J. Kaulahao
J. H. Smith

Honolulu 16 Oct 1852

Helu 8164 Kuaakua

Kahalaun Oahu

9 Loi a ma ke Kula, ma Koloa. E hoomaka ana ma ke kahi Akau, a e holo ana, Kom. 77° Nih. 355 pautu, e pili ana i ke Kuamo. Kom. 47 1/2° Nih. 490 pautu, e pili ana i ke Napela, Kom. 32° Kom. 216 pautu, e pili ana ma Kahawai, AK. 58 1/2° Kom. 124 pautu, e pili ana ma Kalimaoni Kom. 32° Kom. 64 pautu, e pili ana ma Kalimaoni, AK. 62 1/2° Kom. 328 pautu e pili ana ma Kalimaoni, AK. 31° Nih. 100 pautu e pili ana i ke Naumu, AK. 31° Kom. 400 pautu, e pili ana ma Naumu, i ke kahi mua 2/100 Eka.

A. F. Turner
Luna ana aine.

30 Aug 1854

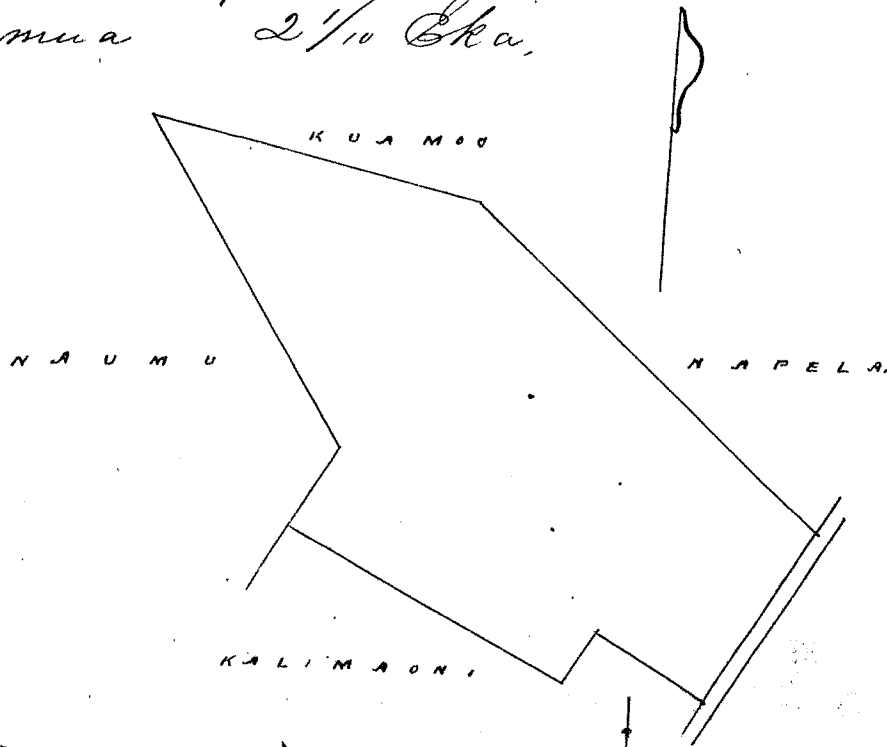

Uku Pau Loa # 5
P. Hee
G. M. Robertson
J. Kekaulahao
J. H. Smith

Honolulu 16 Oct. 1852.

Hele 2240 B Heeia Kanikoa

Kahalaun Oahu

Heeia ma Kukuilolo, Kahalaun, Oahu.

Apana 1. 7 Loi. E hoomaka ana ma ke Pihī Akau, a e holo ana, Hem. 48° Kom. 265
pauku, e pili ana i ke Kaelakāia, Hem. 45° Hik. 400 pauku, e pili ana i ke Kanikoa,
Ak. 4 1/2° Hik. 322 pauku e pili ana i ke Konohiki, Ak. 5 5/8° Kom. 180 pauku e
pili ana i ke Wahanui, Hem. 87° Kom. 40 pauku e pili ana i ke Mahanui Ak. 48°
Kom. 162 pauku, e pili ana i ke Mahanui, i ke Pihī mua, 1/10, Eka.

Apana 2, Pahale, E hoomaka ana ma ke Pihī Akau, Hem. 43° Kom. 275 pauku e
pili ana i ke Konohiki, Hem. 45° Hik. 130 pauku, e pili ana i ke Konohiki, Ak. 43°
Hik. 265 pauku, e pili ana i ke Konohiki, Ak. 41° Kom. 130 pauku, e pili ana i
ke Konohiki, i ke Pihī mua, o 33. Eka.

Apana 3. Loi. E hoomaka ana ma ke Pihī Akau, a e holo ana, Hem. 18°
Hik. 127 pauku e pili ana i ke Kanikoa, Hem. 77° Kom. 185 pauku e pili ana i ke Kono-
hiki, Ak. 2° Hik. 168 pauku, e pili ana i ke Konohiki, Ak. 88° Hik. 127 pauku
e pili ana i ke Konohiki, 1/5 Eka,

7 Aug. 1851

A. F. Turner
Luna ana uina

1.10
33
20
1.63

Heeia's claim acknowledged to be
received in award P. 690. 1852 & no claim
for these apanas
Surveyors error
in placing the name of Heeia
his number on the Survey
which had been left blank
& filled up hastily.
J. H.

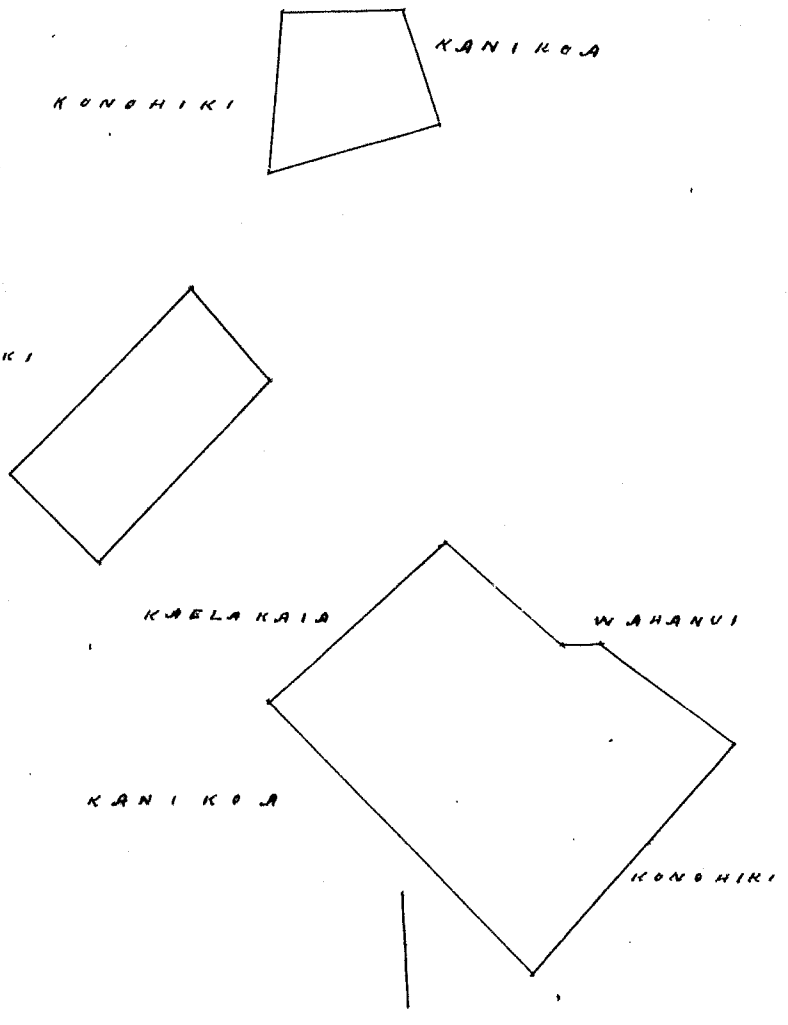

Uku Pau Loa # 6
P. Hee
G. M. Robertson
J. Kekaulahao
J. H. Smith

Honolulu, 16 Oct. 1852

Moo aina Kahalala, ili o Keakua, Manawanui, Ewa Oahu.
 E hoomaka ana ke Kihī Komohana, e holo ana, Ak. 72 1/2. Nīkī, i 0.96 Kh. ma ka palena
 no Kanaa, Malaila aku, Hem. 23. Nīkī, i 2.96 Kh. ma ke Kahanaumaitai, Malaila aku,
 Ak. 50. Nīkī, i 0.25 Kh. Malaila aku, Hem. 32. Nīkī, i 2.42 Kh. Malaila aku, Hem. 41 1/2.
 Nīkī, i 3.40 Kh. ma ke Kahanaumaitai, Malaila aku, Ak. 47 1/2. Nīkī, i 0.37 Kh. Malaila
 aku, Hem. 39 1/2. Nīkī, i 1.44 Kh. ma ka palena no Kekuanaoa, Malaila aku, Hem. 38.
 Kom. i 0.90 Kh. Malaila aku, Hem. 30. Nīkī, i 1.00 Kh. ma ke Kekuanaoa,
 Malaila aku, Hem. 18. Kom. i 0.65 Kh. Malaila aku, Hem. 6 1/2. Kom. i 1.40 Kh.
 ma ke Kanaina, Malaila aku, Ak. 35. Kom. i 1.40 Kh. Malaila aku, Ak. 15 1/2.
 Kom. i 2.20 Kh. Malaila aku, Ak. 29. Kom. i 8.40 Kh. ma ke Kanaina, a hiki
 ke hoomaka ana, 1 Eka 6 7/10 Kh huinaha

A. Bishop,
 mea ana,

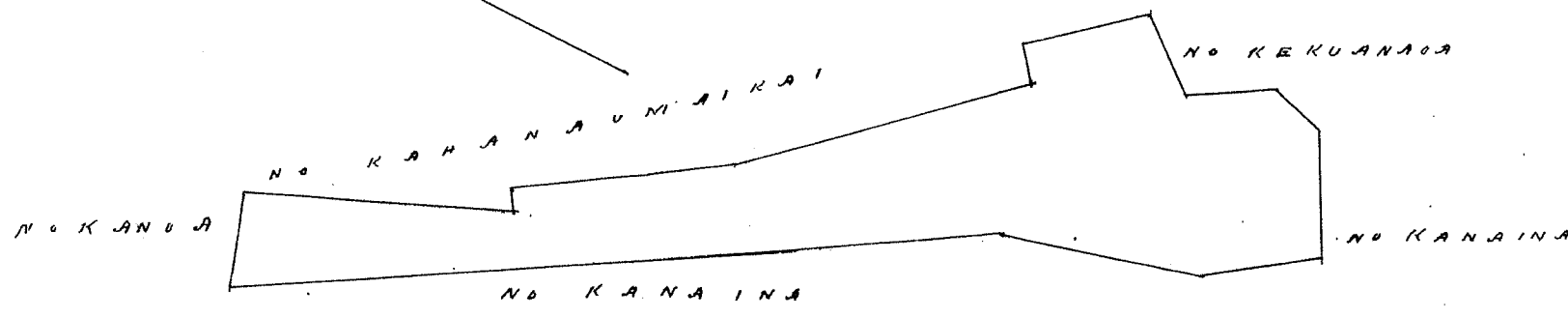

Wks Pau Laa 5

- M. L. Lee
- G. M. Robertson
- J. H. Smith
- J. Schaulakoo

Honolulu 18 Oct 1852

Apana 1. 13 Lvi. and. Kuba, E hoomaka ana ma ke Kihī Akau, a e holo ana, Hem.
 71. Nīkī, 780 pautu, e pili ana i ke Kalimaoni, Hem. 62. Nīkī 2.00 Pautu, e pili ana i ke
 Kalimaoni, Ak. 31. Nīkī 57 pautu, e pili ana i ke Kalimaoni. Hem. 62. Nīkī 2.40 pautu
 e pili ana i ke Kalimaoni, Hem. 21. Kom. 2.30 pautu e pili ana i ke Kuamoo, Ak.
 79. Kom. 2.40 pautu, e pili ana i ke Konoheki, Ak. 59. Kom. 6.70 pautu e pili ana
 i ke Kapuna, Ak. 82. Kom. 3.00 pautu e pili ana i ke Konoheki, Ak. 7. Nīkī 3.00
 pautu, e pili ana i ke Konoheki, i ke Kihī mua, 3 287/1000 Eka,

Apana 2, Tahale, E hoomaka ana ma ke Kihī Akau, a e holo ana, Hem. 23.
 Nīkī 1.86 Pautu, e pili ana i ke Konoheki, Hem. 20. Kom. 2.08 pautu, e pili ana i ke
 Konoheki, Ak. 50. Kom. 1.87 pautu, e pili ana i ke Konoheki, Ak. 40. Nīkī 1.60 pautu
 e pili ana i ke Konoheki, i ke Kihī mua, 0 35/100 Eka

30 Aug 1851

A. F. Turner
 Iuna ana aina

3.287
 3.50
 3.637

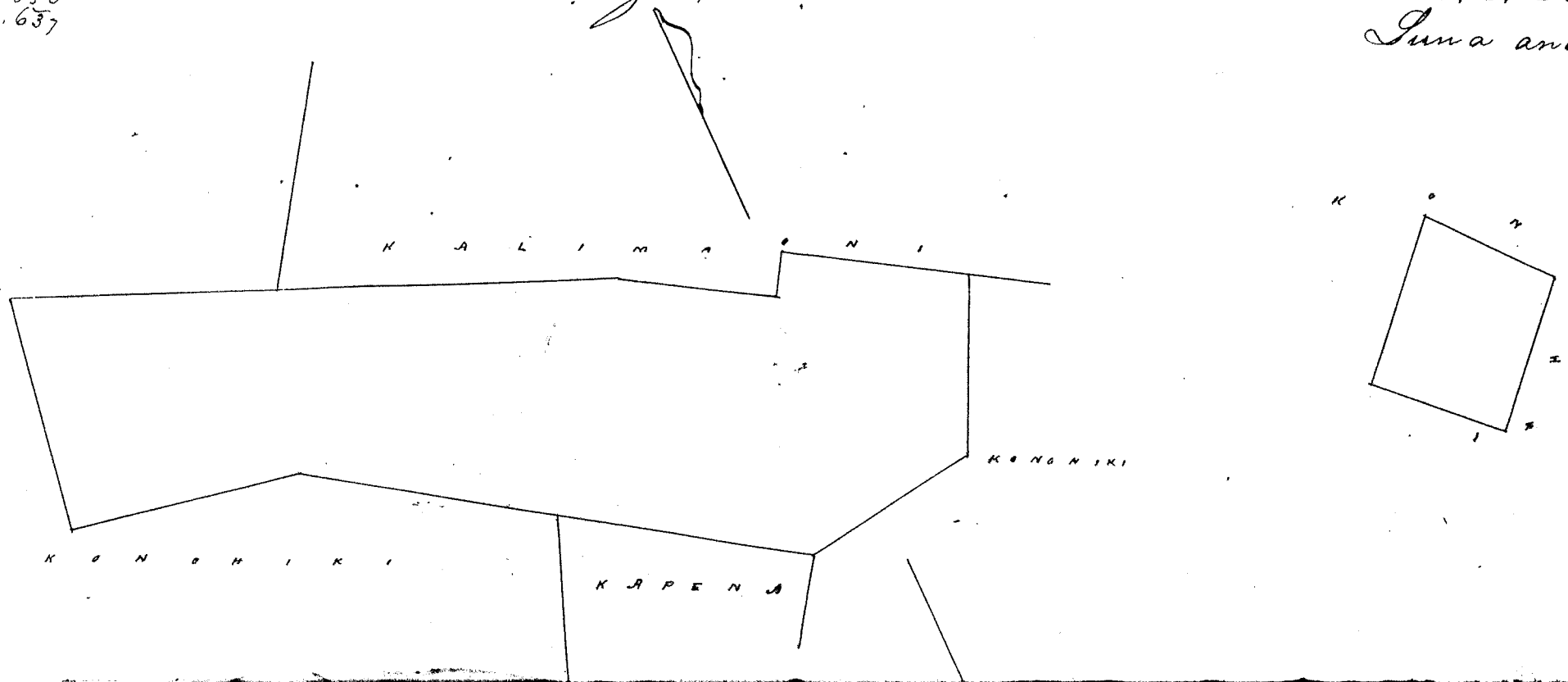

274

Wku Pau Loa # 6.
W. L. Lee
G. M. Robertson
S. Kekaulahao
J. H. Smith

Honolulu 16 Oct 1852

Heleu 1770 Moano

Palea Waikiki Oahu

Moana Piliani ili. Keki Palea Oahu, Chomaka ma ke Pili Akau, a e holo ana. Hem. 61° Kom. 220 Kh. ma ka palena. Kaululoa, Malaila aku, Hem. 61 1/2° Kom. 773 Kh. ma ka palena. Kaululoa, Malaila aku, Hem. 2.00 Kh. Malaila aku, Hem. 32° Hik. 234 Kh. ma ka palena. Kaululoa, Malaila aku, AK. 54 1/2° Hik. 1.80 Kh. ma ka palena no Lolo. Malaila aku, Hem. 80° Hik. 358 Kh. ma ka palena no Lolo, Malaila aku, AK. 35 1/2° Hik. 227 Kh. ma ka palena o Kaululoa, Malaila aku, AK. 15 1/2° Hik. 5.80 Kh. ma ka palena. Kaululoa, a hiki: Ka hoomaka ana, 3 Eka, 7 4/100 Kh. huinaha.

A. Bishop
Moana

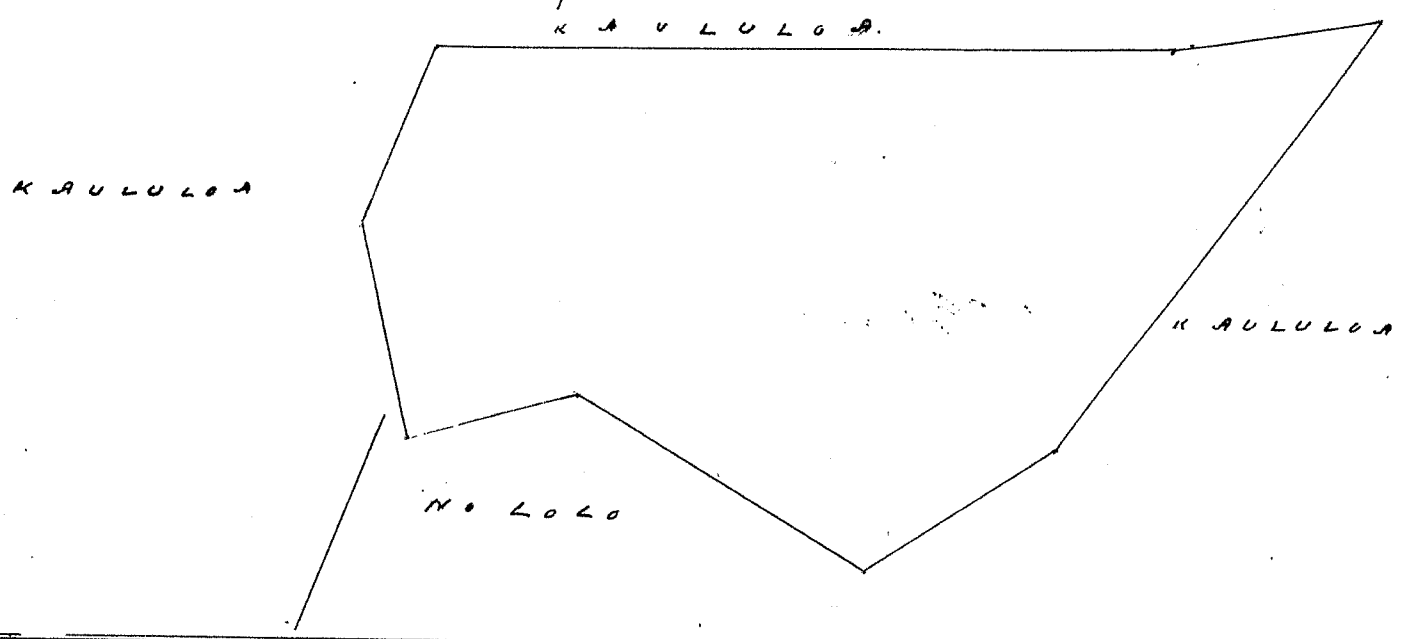

Wku Pau Loa # 7
W. L. Lee
G. M. Robertson
J. H. Smith
S. Kekaulahao

Honolulu 18 Oct 1852

Heleu 2246 Kb. Kealahalaia

Keahahua Oahu

Apana 1. 9 Loi. Chomaka ana ma ke Pili Akau, a e holo ana, Hem. 46° Hik. 136 paunku ma Konoehiki; Hem. 32° Kom. 350 paunku ma Konoehiki; Hem. 57° Kom. 222 paunku ma Konoehiki; AK. 70° Kom. 240 paunku ma Konoehiki; AK. 53° Kom. 499 paunku ma Konoehiki; AK. 16° Hik. 320 paunku ma Kahawai; Hem. 84° Hik. 200 paunku ma Kahawai; Hem. 73° Hik. 164 paunku ma Konoehiki; Hem. 14° Hik. 251 paunku ma Konoehiki; AK. 53° Hik. 198 paunku ma Konoehiki; AK. 27 1/2° Kom. 280 paunku ma Konoehiki; AK. 69° Hik. 305 paunku ma Kahawai; i ke Pili mua, 5 4/10 Eka.

Apana 2, 2 Loi. Chomaka ana ma ke Pili Akau, a e holo ana, AK. 28° Kom. 222 paunku ma Kanaoa, AK. 22° Hik. 1.00 paunku ma Konoehiki; Hem. 56 1/2° Hik. 220 paunku ma Ke Wahanaui; Hem. 50° Kom. 210 paunku ma Ikaia; i ke Pili mua, 32/100 Eka.

Apana 3. Kahualala, Chomaka ana ma ke Pili Akau, a e holo, AK. 39° Kom. 158 paunku ma Konoehiki; AK. 51° Hik. 158 paunku ma Konoehiki; Hem. 39° Hik. 158 paunku ma Konoehiki; Hem. 51° Kom. 158 paunku ma Konoehiki; i ke Pili mua, 1/4 Eka.

A. F. Turner
Luna ana aina

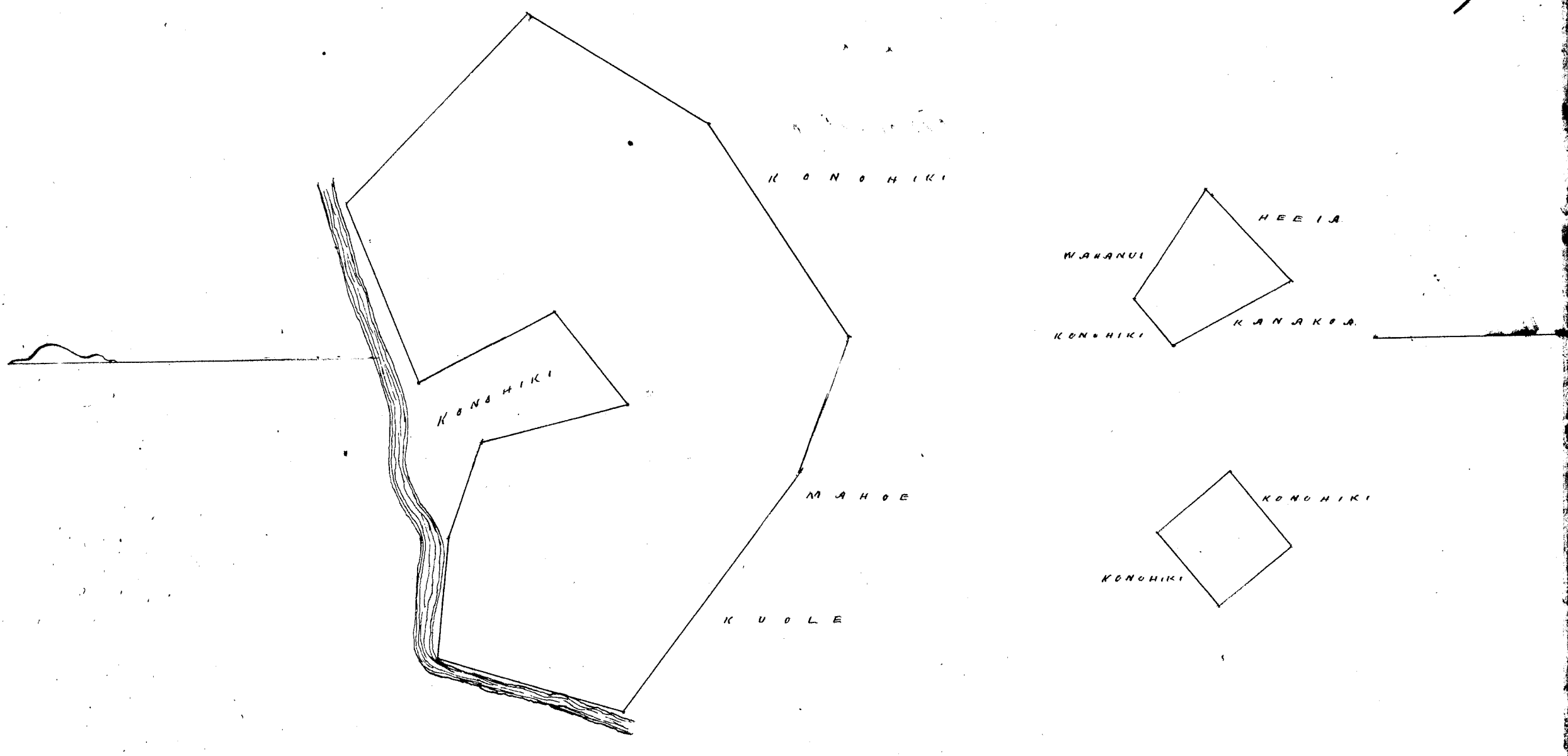

Wku Pau Loa # 9.
 W. L. L.
 S. M. Robertson
 J. Kaulahao
 J. H. Smith

Honolulu 16. Oct. 1852

Kolu 3699^B Kainoahou. Laie, Oahu.

Apawa 1. 2 Lwi. Chomaka ana ma ke Pihik Akau, a e holo ana, Hem. 64° Kom. 96 pautu, e pili ana i ke Keliwawaiwole, Hem. 34° Hik. 330 pautu, e pili ana i ke Keliimakui, Ak. 67° Hik. 95 pautu, e pili ana i ke Konoiki, Ak. 34 1/2, Kom. 335 pautu, e pili ana i ke Pahunua, a hiki i kahi i hoomaka i 324,000 Eka,

Apawa 2. Aiva Kula, Chomaka ana ma ke Pihik Akau, a e holo ana, Hem. 52° Kom. 300 pautu e pili ana i ke Pupuaka, Hem. 47° Hik. 400 pautu, e pili ana i ke Konoiki Ak. 67° Hik. 200 pautu e pili ana i ke Konoiki, alaila e pili ana i ka pali, a hiki i kahi i hoomaka i 1 Eka,

30 May 1851.

A. F. Turner, Luna ana aina

324
 250
 1.574

Apawa 3. Pahale, Chomaka ana ma ke Pihik Akau, a e holo ana, Ak. 40° Kom. 160 pautu, ma Konoiki, Ak. 50° Hik. 160 pautu ma Konoiki, Hem. 40° Hik. 160 pautu, ma Konoiki, Hem. 50° Kom. 160 pautu ma Konoiki i ke Pihik ana 1/4 Eka,

A. F. Turner, Luna ana aina

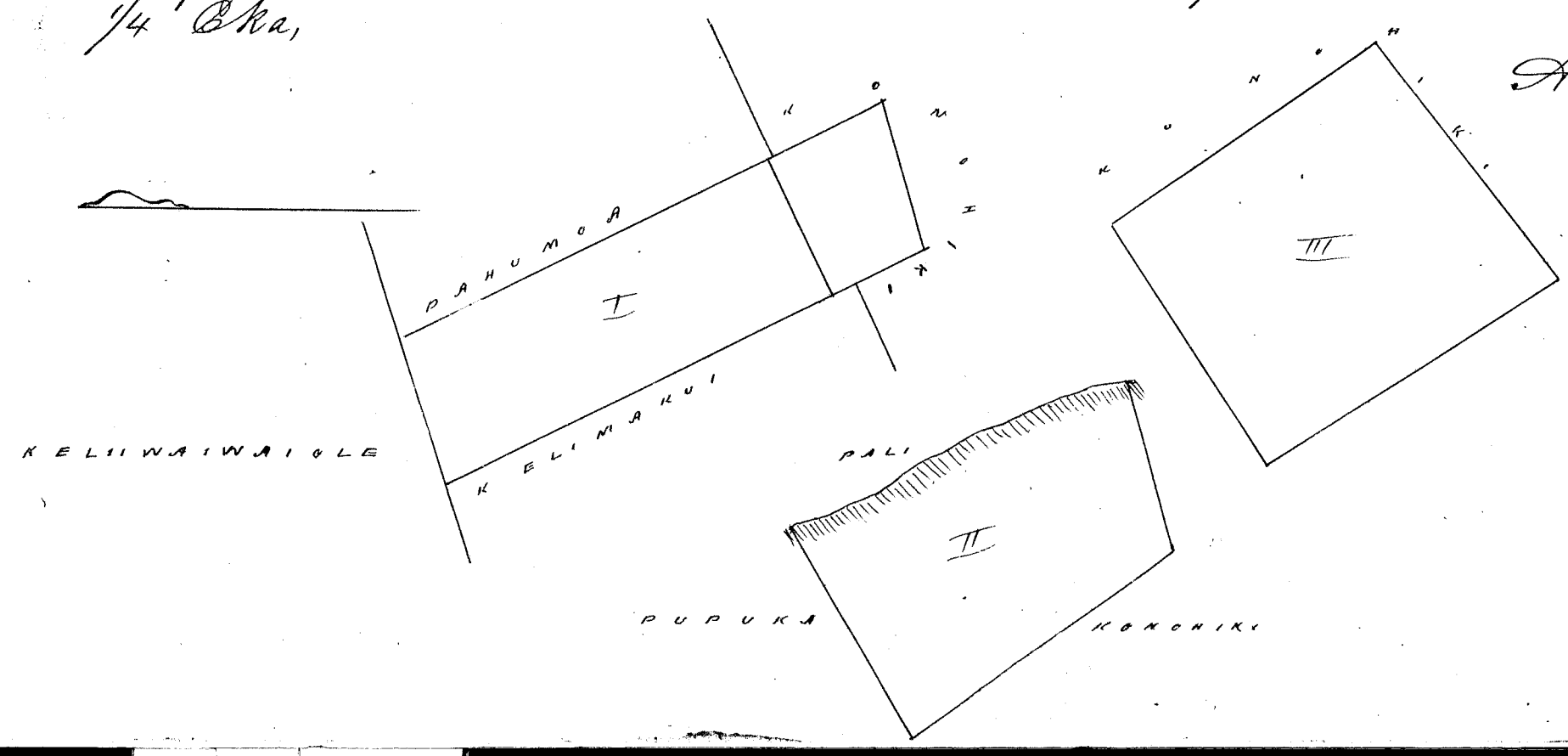

Uku Pau Loa # 5.
W. L. Lee
G. M. Robertson
I. Kekaualakao
J. H. Smith

Honolulu 16 Oct 1852.

Helu 6040 Chu

Heia Oahu

Chu Ma Tumawai, Heia.

Aprana 1, 4 Loi. Chromaka ana ma ke Pihia Akau, Hem. 42 1/2, Kom. 200 pautu
e pili ana i ke ke Konohiki, Hem. 34, Hik. 110 pautu, e pili ana i ke ke Konohiki, Ak. 55.
Hik. 55 pautu, e pili ana i ke Napua, Hem. 37 1/2, Hik. 225 pautu, e pili ana i
ke Napua, Ak. 37 1/2, Hik. 260 pautu, e pili ana i ke Konohiki, Ak. 43, Kom. 190
pautu, e pili ana i ke Konohiki, Ak. 73, Kom. 146 Pautu e pili ana i ke Konohiki
i ke Pihia mua, 8/100 Eka,

Aprana 2, Pahale 1/2 ke Chu 1/2 ke Nahuina Chromaka ana ma ke Pihia
Hema, a e holo, Ak. 48, Kom. 320 pautu e pili ana i ke ke Konohiki, Ak. 48,
Hik. 227 pautu, e pili ana i ke ke Konohiki, Hem. 48, Hik. 267 pautu e pili ana
i ke ke Kai, Hema 35 Kom. 236, pautu e pili ana i ke Heina, i ke Pihia mua
66/100 Eka,

21 July 1852

A. F. Turner.
Luna ana aina,

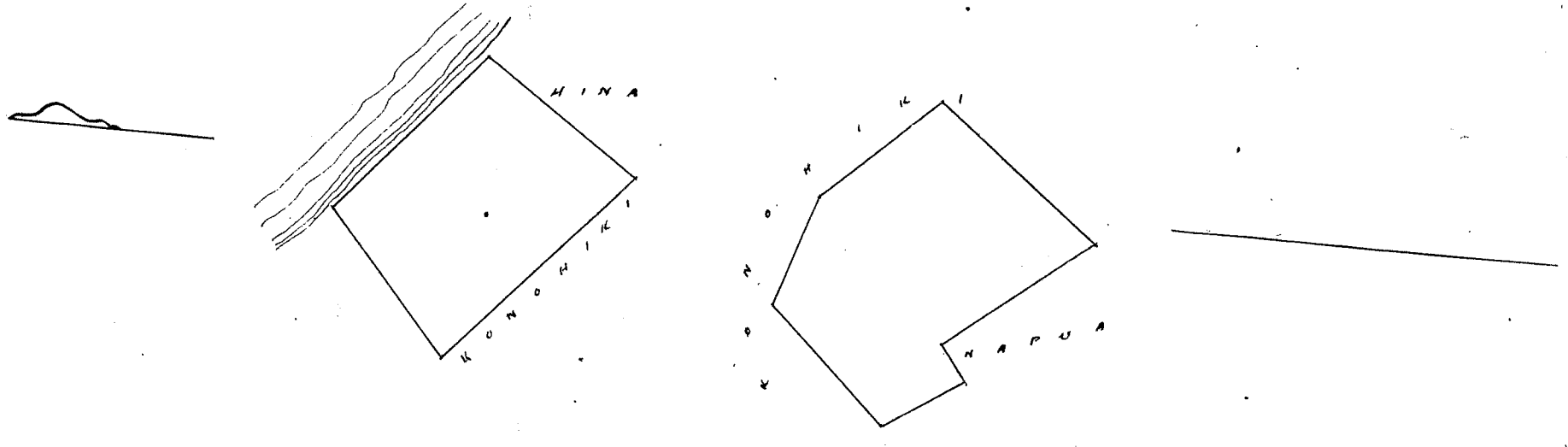

Uku Pau Loa # 4
W. L. Lee
G. M. Robertson
I. Kekaualakao
J. H. Smith

Honolulu 16 Oct 1852

Helu 2246 2 Heueu

Waiehu Oahu

Heueu one Waiehu.

Aprana, 1, 4 Loi, a me Kula, Chromaka ana ma ke Pihia Hema, a e holo ana.
Ak. 33 Kom. 270 pautu, e pili ana i ke Makole, Hem. 49, Kom. 96 pautu e pili
ana i ke Makole, Ak. 28, Kom. 150 pautu, e pili ana i ke Konohiki, Ak. 11, Kom.
329 pautu, e pili ana i ke Konohiki, Ak. 74, Hik. 77 pautu, e pili ana i ke
Konohiki, Hem. 37, Hik. 707 pautu, e pili ana i ke Kahalekaha, Hem. 63, Kom. 159
pautu, e pili ana i ke Makole, i ke Pihia mua, 1 1/100 Eka,

12 Oct 1851.

A. F. Turner.
Luna ana aina,

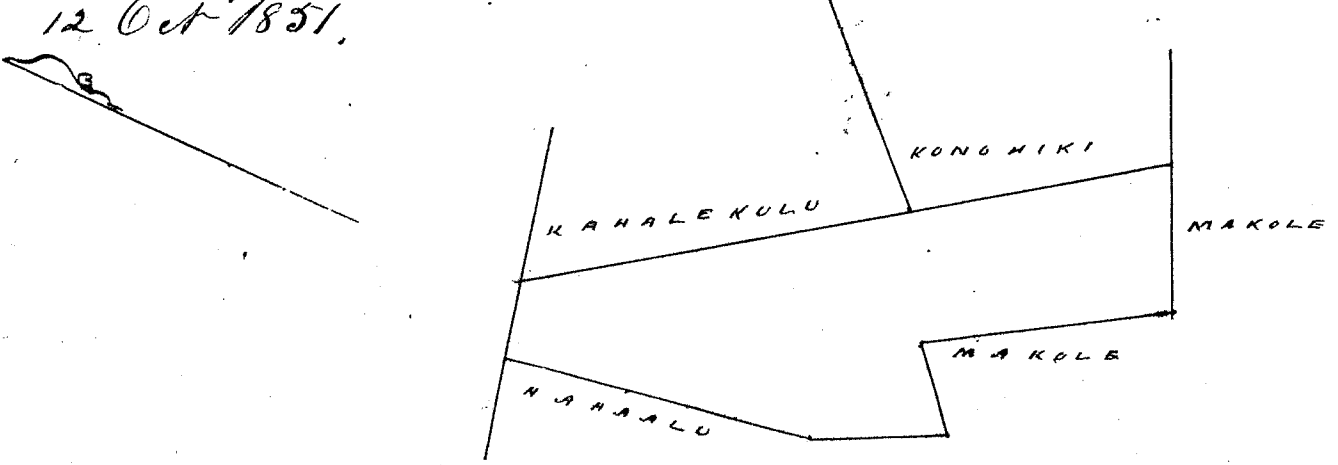

Uku Pau Loa # 6

W. L. Heu
G. M. Robertson
J. Kaulahao
J. H. Smith

Honolulu 16 Oct 1852

Heleu 8164 La) Kalima

Kaliuanui, K. Oahu

Apana 1. 5 Lri; E hoomaka ana ma ke Pili Hema, a e holo, Ak. 66; Hik. 600 pautu, ma Konoheki; Hem. 25; Hik. 90, pautu, ma Konoheki; Ak. 58; Hik. 190 pautu ma Konoheki; Ak. 32; Kom. 360 pautu ma Konoheki; Hem. 57; Kom. 784 pautu ma Konoheki; Hem. 3 3/2; Hik 180 pautu ma Konoheki, i ke Pili mua, 2 Eka,

Apana 2. Pahale, E hoomaka ana ma ke Pili Hema, a e holo, Ak. 28; Kom. 160, pautu, ma Konoheki; Ak. 62; Hik 160 pautu ma Konoheki; Hem. 28; Hik. 160 pautu, ma Konoheki; Hem. 62; Kom. 160 pautu, ma Konoheki; i ke Pili mua, 1/4 Eka.

28 Nov. 1852.

A. F. Turner
Luna ana aina

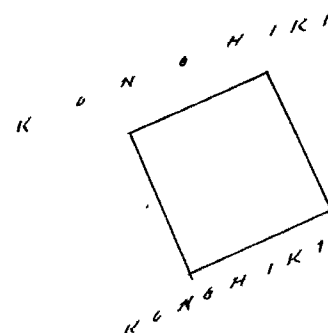
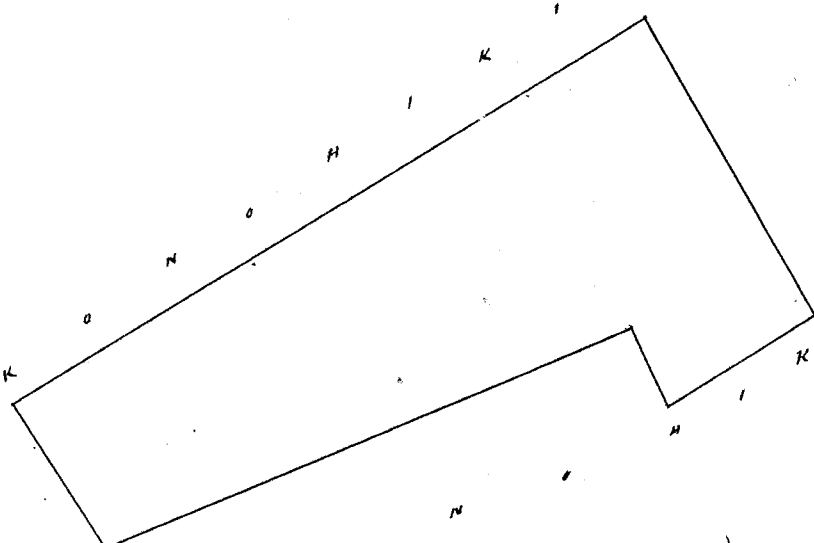

Uku Pau Loa # 7

W. L. Heu
G. M. Robertson
J. Kaulahao
J. H. Smith

Honolulu 16 Oct 1852.

Heleu 8095 Hoauhu

Paalaa Waialua Oahu

Ke Hoauhu Kuleana ma Akala, Paalaa Waialua.

Apana 1. Kona aina ma Akala, Hoomaka ma ke Kahiko kiki Kom. Ak. ma Pua, holo Hem. 78 1/2; Kom. 70, ma Pua, holo, Hem. 8 1/4; Kom. 660 ma Pii via ke Konoheki; Holo Hem. 44 1/2; Hik 184, ma Pii via ke Konoheki, holo Hema 54 1/2; Kom. 155 ma Pii via ke Konoheki, holo Hem. 30 1/2; Hik 152 ma Mais, holo, Ak. 50 3/4; Hik 277 ma Kaha holo, Ak. 35; Kom. 98 ma mais, Ak. 58; Hik 99, ma mais, Ak. 28; Kom. 203, ma Kahiko, holo, Ak. 11 1/2; Kom. 293, ma Kahiko, Ak. 77 1/2; Hik. 4077 ma Kahiko, holo Ak. 5 Kom. 248 ma Kahiko i ke Pili mua, Area 122 Eka,

Apana 2. Kona Kahuahale ma Paalaa kai, Hoomaka ma ke Pili Kom. Hema, i ke Kahiko pahale, holo Hem. 75; Hik. 250 ma Kahiko, holo Hem. 15; Kom. 100 holo ka pa aina, holo Ak. 75; Kom. 250 ma ke Awaau pahale, holo Ak. 15; Hik 100 ma Konoheki, i ke Pili mua Area, 0 25 o ka Eka,

Waialua July 20, 1852.

J. S. Emerson,
mea ana.

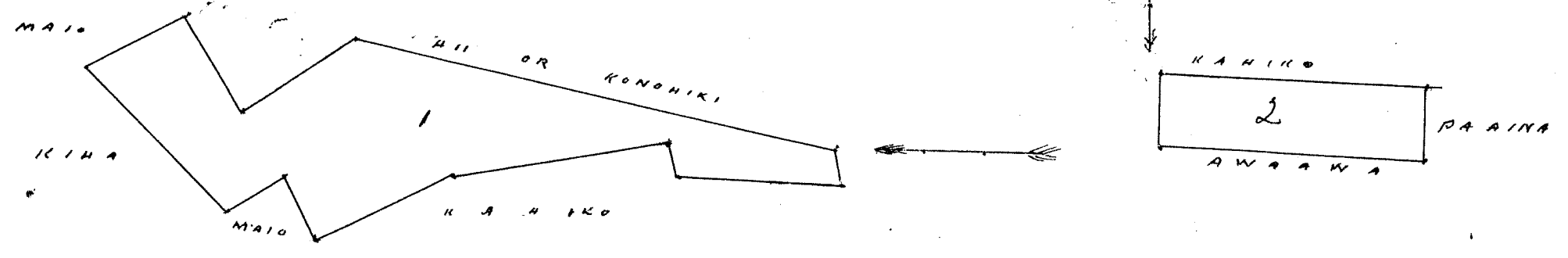

Whe Pau Loa # 5
 W. Hee
 G. M. Robertson
 J. Kekaulaha
 J. H. Smith

Honolulu 19 Oct 1852

Hele 2246 R. Hawaii
 Kahahele Koolau Oahu

Hawaii ma Keaupule, Kahahele.
 Apana 1. Lii. Chromaka ana ma ke Pihii Nema, a e holo, Ak. 54; Kom. 523 paunuu
 ma Nahahele, Ak. 61; Hii. 148 paunuu ma, Nahahele, Hem. 38; Hii. 519 paunuu ma Nahahele
 Hem. 64; Kom. 95 paunuu ma Lii, i ke Pihii mua, 6/100 Eka.

Apana 2, 1 Lii. Chromaka ana ma ke Pihii Aka, a e holo ana, Hem. 1; Hii. 160
 paunuu ma Konohele; Hem. 68; Hii. 90 paunuu ma, Kanahele, Ak. 66; Hii. 76 paunuu
 ma Kanahele, Ak. 43; Kom. 226 paunuu ma Nahahele, i ke Pihii mua 1/100 Eka.

Apana 3, Kahahele, Chromaka ana ma ke Pihii Nema, a e holo ana, Ak. 40;
 Kom. 145, paunuu ma Konohele, Ak. 48 1/2; Hii. 200 paunuu ma Ehu. Hem. 33; Hii. 200
 ma Konohele; Hem. 65; Kom. 185 paunuu ma Konohele; i ke Pihii mua, 3/100 Eka.

19. Nov 1851.

A. J. Turner.
 Luma ana aia

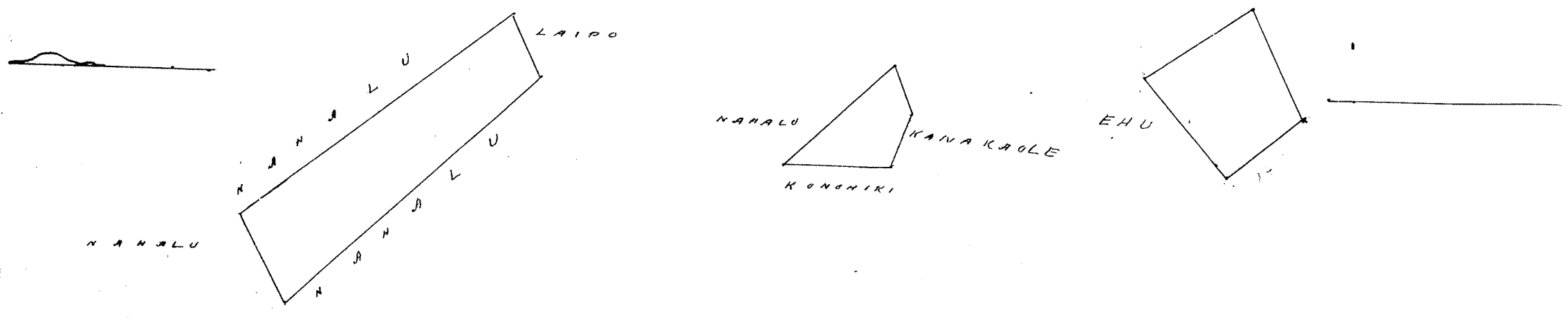

Whe Pau Loa # 5
 W. Hee
 G. M. Robertson
 J. Kekaulaha
 J. H. Smith

Honolulu 16, 1852 Oct.

Kamaala ma Kahuani
 Aprama 1. 2 Lii Kalo. E hoomaka ana ma ke Pihii Akau, a e holo ana, Nem. 48° Kom. 560
 prauku e pili ana i ke Kaipiiho, Nem. 43° Nih 285 prauku e pili ana i ke Konohiki, AK. 42°
 Kom. 410 prauku, e pili ana i ke Pakeo. a holo pili ana i ka papahaku, a hiki i Kahi i
 hoomaka i 1¹⁷/₁₀₀ Eka,

Aprama 2. 2 Lii Kalo. E hoomaka ana ma ke Pihii Akau, a e holo ana, Nem. 34°
 Nih 238 prauku e pili ana i ke ke Konohiki, Nem. 53° Kom. 465 prauku e pili ana i ke Pakeo,
 AK. 36¹/₂, Kom. 124 prauku e pili ana i ke Konohiki, AK. 42¹/₂, Nih 2,00 prauku, e pili ana
 i ke Kaipiiho, AK. 34 Kom. 32 prauku, e pili ana i ke Kaipiiho AK. 43, Nih 288 prauku
 e pili ana i ke Kaipiiho, a hiki i Kahi i hoomaka i 8⁵/₁₀₀ Eka,

Aprama 3. Aina Kula, E hoomaka ana ma ke Pihii Akau, a e holo ana, AK. 50°
 Ke 186 prauku, e pili ana i ka pali, AK. 2° Kom. 1350 prauku e pili ana i ke
 Konohiki, AK. 79° Nih 134 prauku e pili ana i ke Konohiki, Nem. 2° Nih 1500 prauku e
 pili ana i Konohiki, a hiki i Kahi i hoomaka i 2 Eka,

Honolulu, 17, May 1851

A. F. Turner,
Luna ana aina

1.17
85
2
4.02

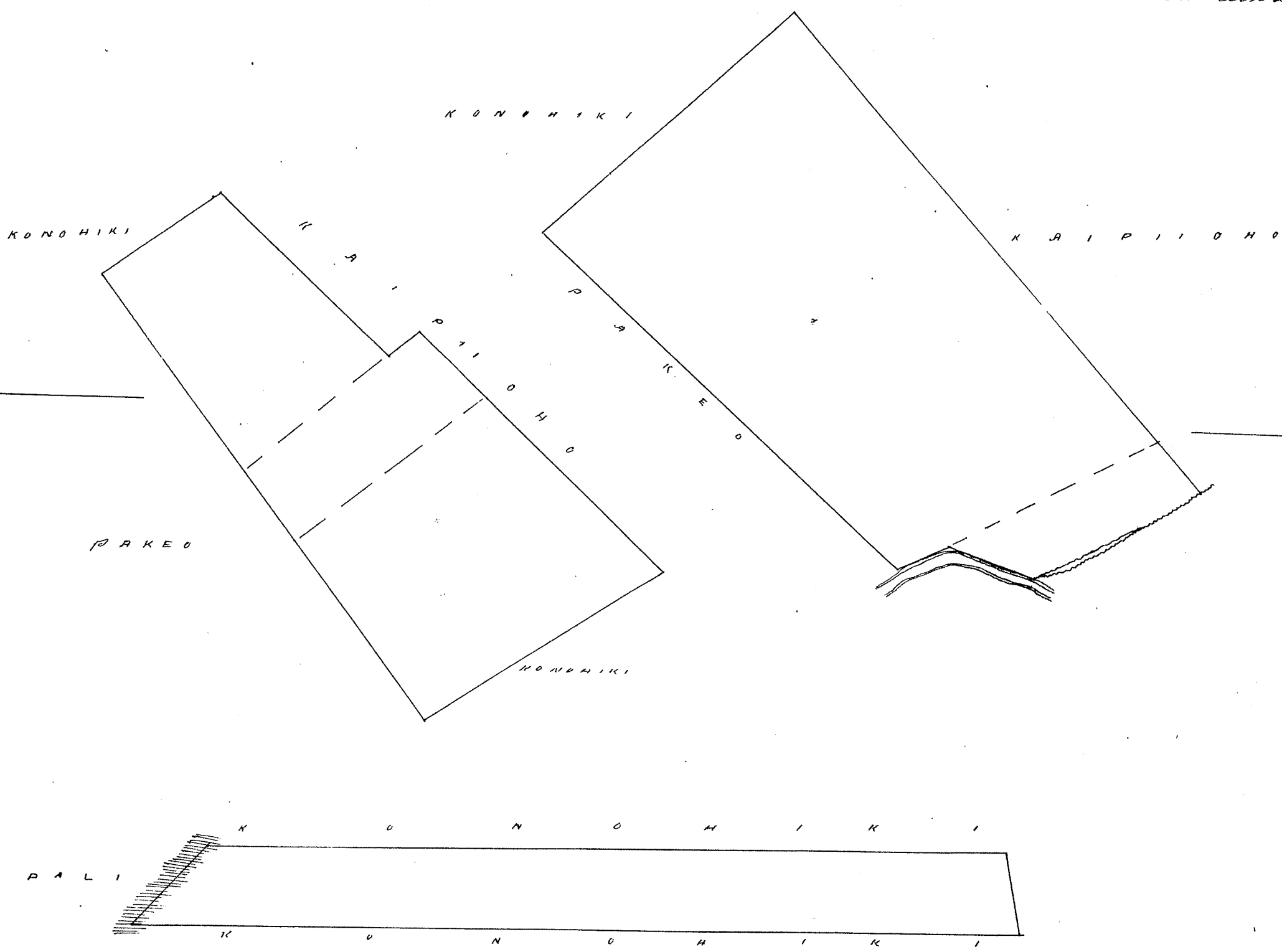

Uku Pau Loa # 7
 W. L. Lee
 G. M. Robertson
 J. Kakaalaka
 J. H. Smith

Honolulu, 16. Oct. 1852

Apana 1. 3 Loi. E hoomaka ana ma ke Pihī Nema, a e holo ana, Ak. 26 1/2; Kom. 350 paauku ma Konoehiki, Ak. 67; Nih 183 paauku ma Waieae, Hem. 32; Nih 92 paauku ma Kaniko Hem. 69; Kom. 95 paauku ma Kaniko, Hem. 27; Nih. 2,00 paauku ma Kaniko, Ak. 57; Nih 57 paauku ma Kaniko, Hem. 37 1/2. Ni. 44 paauku, ma Kaniko, Hem. 56 1/2; Kom. 130 paauku, ma Konoehiki, i ke Pihī mua, 38/100 Eka.

Apana 2. 5 Loi. E hoomaka ana ma ke Pihī Nema, a e holo, Ak. 23; Kom. 161 paauku ma ke Pōa, Ak. 26 Kom. 150 paauku ma ke Kaniko, Hem. 59; Kom. 60 paauku, ma ke Kaniko, Ak. 28; Kom. 228 paauku, ma ke Kaniko, Ak. 54; Nih 3,00 paauku ma ke Konoehiki, Hem. 26; Nih 600 paauku ma ke Keliakapu Hem. 67 Kom. 213 paauku, ma Kealahou, i ke Pihī mua, 1. 4/10 Eka.

Apana 3. Pahale. E hoomaka ana ma ke Pihī Nema, a e holo ana, Ak. 25; Kom. 158 paauku ma Konoehiki, Ak. 65; Nih 158 paauku, ma Konoehiki; Hem. 25; Nih 158 paauku ma Konoehiki; Hem. 65; Kom. 158 paauku ma Konoehiki; i ke Pihī mua, 1/4 Eka
20. Nov. 1851.

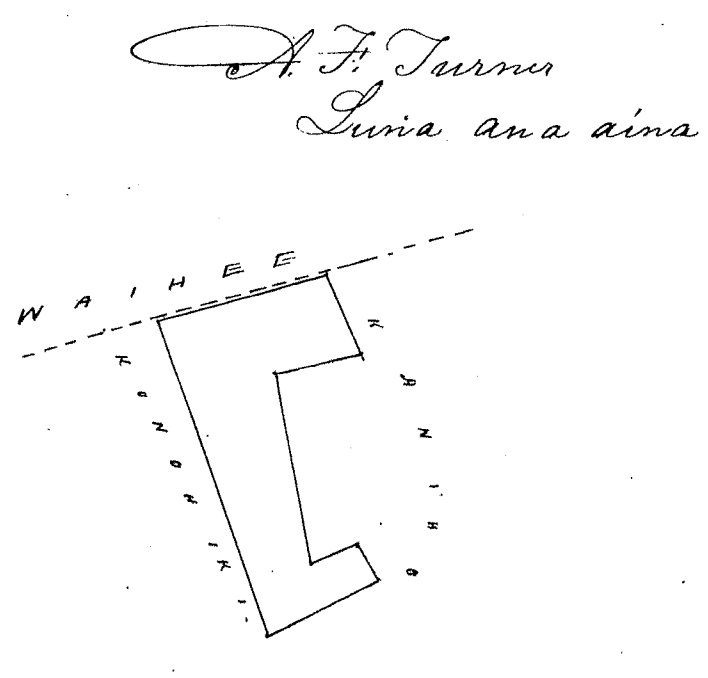
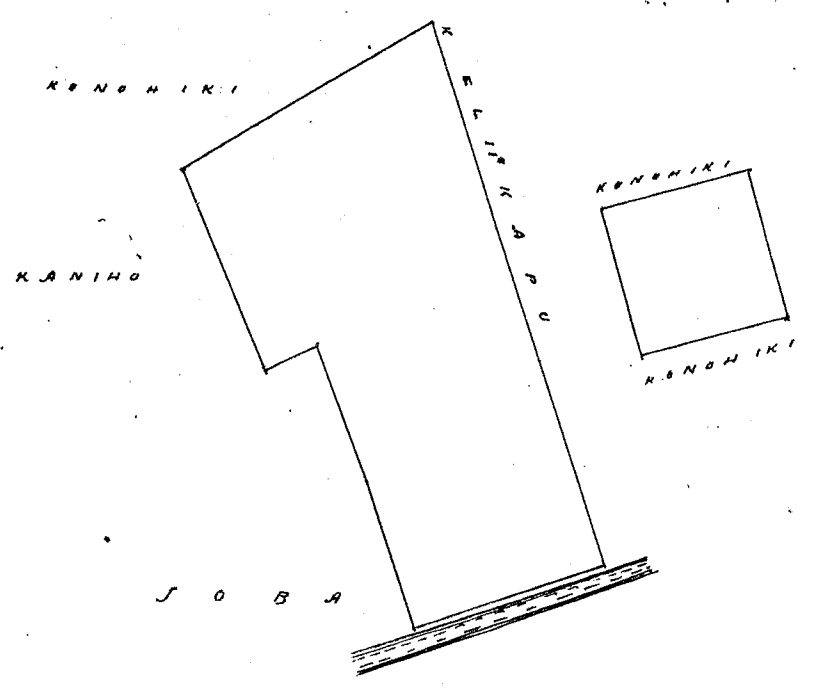

A. F. Turner
Lunia ana aina

38
1.40
25
2.03

Uku Pan Ipa #6
W. H. H. H.
G. M. Robertson
J. K. K. K.
J. M. Smith

Honolulu 16 Oct 1852.

Apana 1. 2 Loi. E hoomaka ana ma ke Pihī Nema, a e holo, Ak. 26; Kom. 148 paauku ma Keaka, Ak. 68; Nih 184 paauku ma Keaka, Hem. 26; Kom. 149 paauku, ma Hachae, Hem. 68; Kom. 196. paauku ma Hachae, i ke Pihī mua, 29/100 Eka.

Apana 2. 4 Loi. E hoomaka ana ma ke Pihī Nema, a e holo ana, Ak. 39; Kom. 2,00 paauku ma Hachae, Ak. 58; Nih 1362 paauku ma Hachae, Hem. 27; Nih 1449 paauku ma Kaulaui, Hem. 50; Kom. 3,32 paauku ma Hachae, i ke Pihī mua, 58/100 Eka

Apana 3. Kula. E hoomaka ana ma ke Pihī Nema, a e holo ana, Ak. 49; Nih. 274 paauku, ma Koloakea, Ak. 15; Nih 438 paauku, ma Koloakea, Ak. 19; Nih. 374 paauku ma Koloakea, Ak. 83; Kom. 430 paauku ma Konoehiki; Hem. 9; Kom. 1,000 paauku, ma ke Konoehiki; Hem. 77; Nih 1,30 paauku ma ke pali, i ke Pihī mua 3 3/4 Eka.

28 Nov 1851

A. F. Turner.
Lunia ana aina

29
58
334
4.21

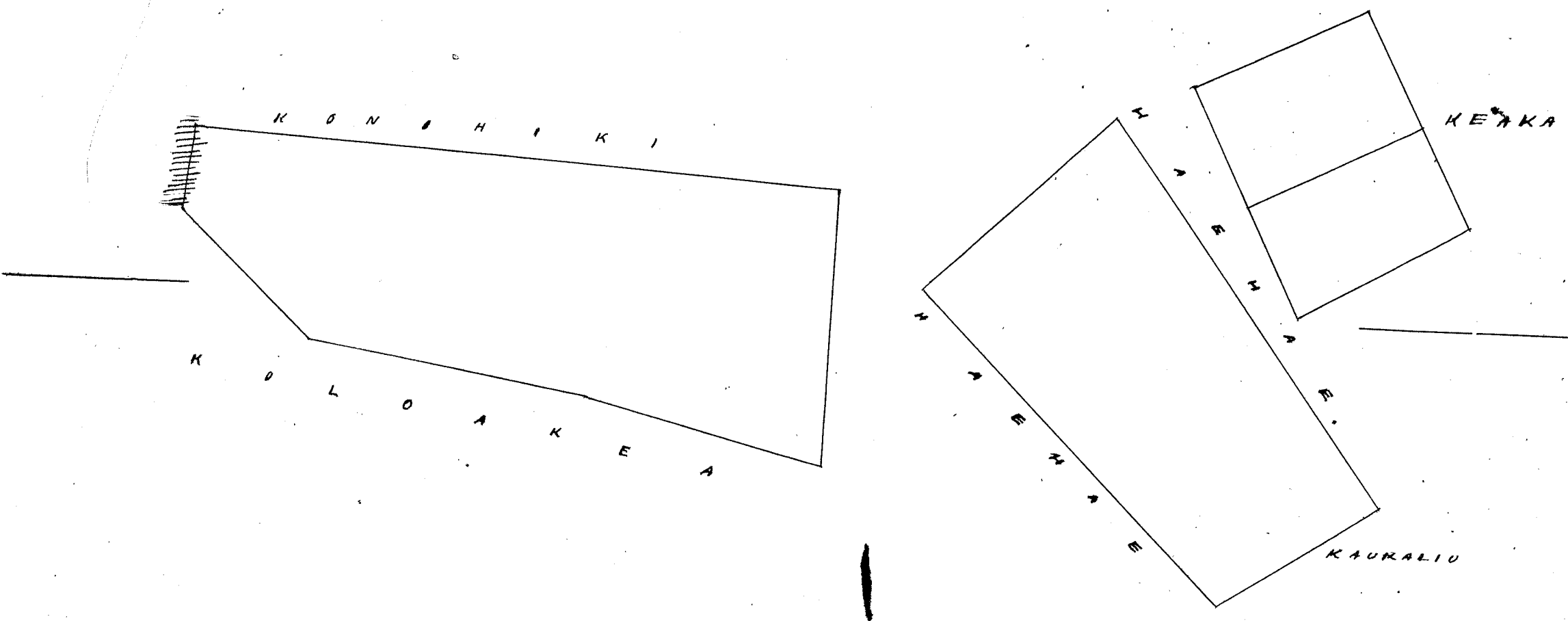

Uku Pau Loa # 8
 W. L. L. L.
 G. M. Robertson
 S. Kukaiahoo
 J. H. Smith

Honolulu 16 Oct 1852

Keele 2421 J. S. Koaawa

Waihu Moari

Apawa i. Mahi i. Iki Pahiki. Chomaka ke ana ma ke kiki Hihina, o keia, e pili ana ma ka Poalima, Ak. 38 1/4. Kom. 133 Kh. ma Poalima, Kom. 50 1/2. Kom. 90 Kh. ma Palulu, Kom. 20. Hiki 78 Kh. ma Palulu, Ak. 54. Hiki 32 Kh. ma Naoho, Ak. 74. Hiki 57 Kh. ma Naoho, Ak. 67. Hiki 58 Kh. ma Poalima, a hiki i kahi i hoomakaa, a maloko via anapuni 12/100 Eka.

Mahi II Chomaka ke ana ma ke kiki Hea o keia ke kiki Hihina o Pu, Kom. 70 1/2 Kom. 570 Kh. ma Pu, Kom. 62. Kom. 309 Kh. ma Ka Akauhama, Kom. 29 1/4. Hiki 59 Kh. ma Wahalehi, Hiki 36. Hiki 67 Kh. ma Poalima, Ak. 56 1/4. Hiki 65 Kh. ma Poalima, Kom. 33 1/2. Hiki 167 Kh. ma Ka Poalima, Ak. 54 1/4. Hiki 234 Kh. ma Konehiki, Poalima, Kom. 31 1/4. Hiki 140 Kh. ma Poalima, Ak. 61. Hiki 206 Kh. ma Ka Iki. Palileaha, Kom. 37 1/2. Hiki 86 Kh. ma Ka Iki. Palileaha, Ak. 56 1/4. Hiki 150 Kh. ma Poula, Ak. 30. Kom. 318 Kh. ma Poalima, Ak. 56 3/4. Hiki 162 Kh. ma Ka Poalima, Kom. 31. Hiki 308 Kh. ma Ka Poalima, Ak. 59 3/4. Hiki 157 Kh. ma Konehiki, Ak. 38 1/4. Kom. 328 Kh. ma ke alanui, a hiki ma kahi i hoomakaa, a maloko via anapuni 2 1/4 Eka.

Poalima, Chomaka ke ana ma ka pahua o keia Kuluana, ke kiki Hea o keia, Ak. 25. Kom. 119 Kh. Ak. 75. Hiki 60 Kh. Kom. 30 1/2. Hiki 100 Kh. Kom. 53 1/2. Kom. 71 Kh. a hiki ma kahi i hoomakaa, a maloko via anapuni 6/100 Eka.

Wailuku July 10, 1852

John S. Gover
 Mea ana iima.

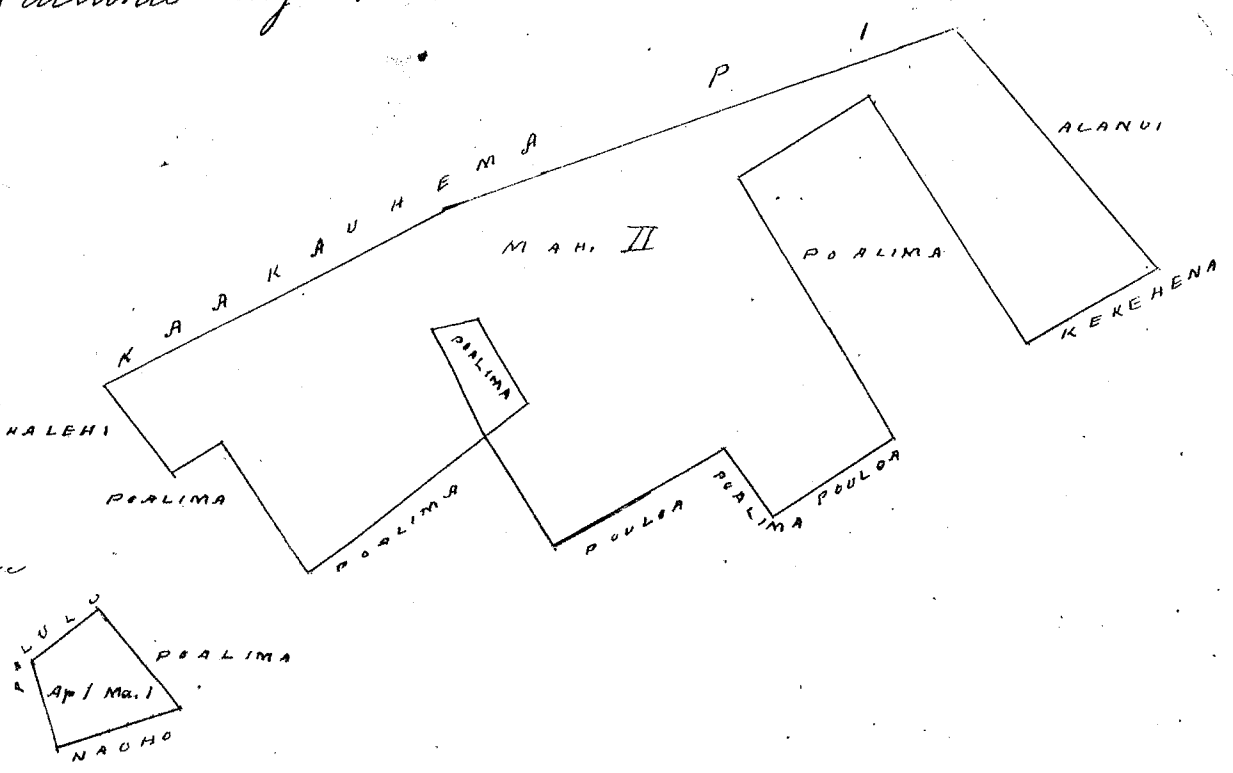

This award returned
 E. Paila to arrange
 with C. Cleimant
 at the... but reports
 E. B. to Com. that
 the parties never appeared
 to arrange their difference
 was sent back to Com.
 Dec 19, 1854

Uku Pau Loa P 6
W. H. K.
G. M. Robertson
J. H. Kaulahao
J. H. Smith

Honolulu 16 Oct 1852

Kelua 3710^B Kamakawai | Waikuu Maui

Apana I Ili Luhu. E hoomaka ke ana ma ke Pihikui Komoehana o keia, Ak. 54 1/2; Nih 65 Kh. ma ka auwai; Nih 34 1/2; Nih 229 Kh. ma ke Konoehiki; Nem. 19 1/2; Kom. 59 Kh. ma ke Konoehiki; Ak. 36 1/2; Kom. 235 Kh. ma ke Konoehiki; a hiki ma kahi i hoomaka i a maloke via Anapuni; 14/100 Eka.

Apana II & III. Ili Holile & Kapuna. E hoomaka ke ana ma ke Pihikui Akau, o keia e pili ana me ke Kula. Nem. 1 1/2; Kom. 202 Kh. ma ke Konoehiki; Nem. 24 1/2; Nih 170 Kh. ma ke Kamakawai; Nem. 80 Nih 146 Kh. ma ke Hoanaepuu; Nem. 32; Nih 100 Kh. Hoanaepuu; Nem. 52 Kom. 51 Kh. ma ke Konoehiki; Hoanaepuu; Nem. 33; Nih 120 Kh. ma ke Hoanaepuu; Ak. 36; Nih 97 Kh. ma ke Hoanaepuu; Ak. 35 1/2; Kom. 183 Kh. ma ke Poalima; Ak. 26 1/4; Kom. 106 Kh. ma ke Kuloaulani; Ak. 21; Kom. 235 Kh. ma Kula; a hiki ma kahi i hoomaka i a maloke via anapuni; 64/100 Eka

Waikuu July 10, 1852

John S. Gower
Ma ana aina

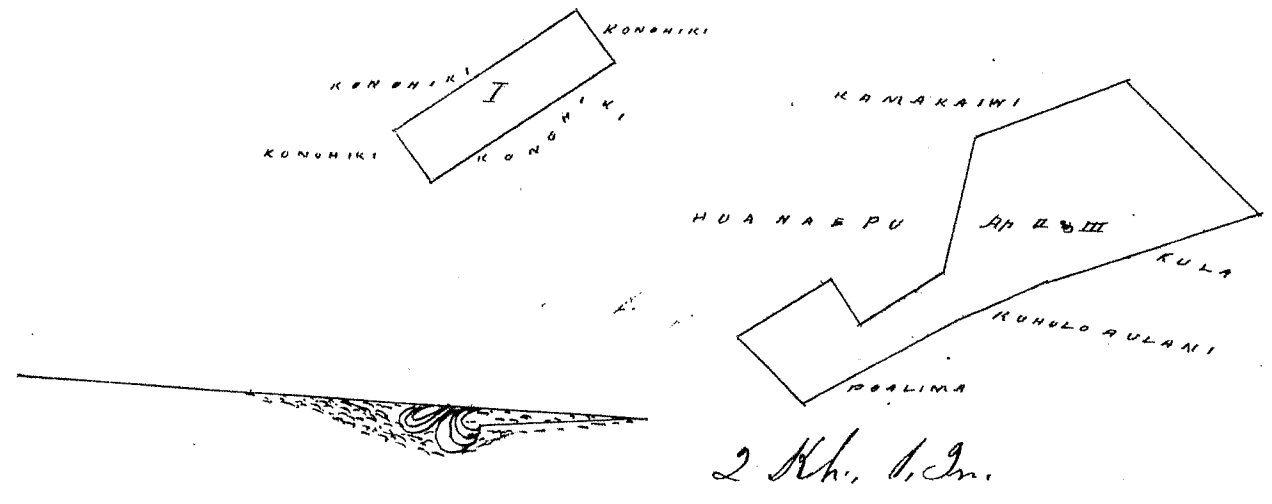

Uku Pau Loa P 6
W. H. K.
G. M. Robertson
J. H. Smith
J. H. Kaulahao

Honolulu 16 Oct 1852

Kelua 3997 Keolu | Waikuu Maui

Ili o Koiaki E hoomaka ke ana ma ke Pihikui Akau, o Kekoehana, Ak. 61; Nih 38 Kh. ma ke Poalima; Ak. 33 1/2; Kom. 371 Kh. ma ke Kuloaulani; Nem. 67 3/4; Kom. 107 Kh. ma ke Kula; Nem. 32; Nih 91 Kh. ma ke Poalima; Nem. 58 1/2; Kom. 262 Kh. ma Aki; Ak. 25 1/2; Kom. 125 Kh. ma ke Poalima; Ak. 65 1/2; Nih 187 Kh. ma ke auwai; Nem. 32; Nih 100 Kh. ma ke Poalima; Ak. 58 1/2; Nih 60 Kh. ma ke Aki; Nem. 40 1/4; Nih 262 Kh. ma ke Aki; Nem. 82 Nih 53 Kh. ma ke Poalima; a hiki ma kahi i hoomaka i a maloke via anapuni; 59/100 Eka.

Waikuu July 7, 1852

John S. Gower
Ma ana aina

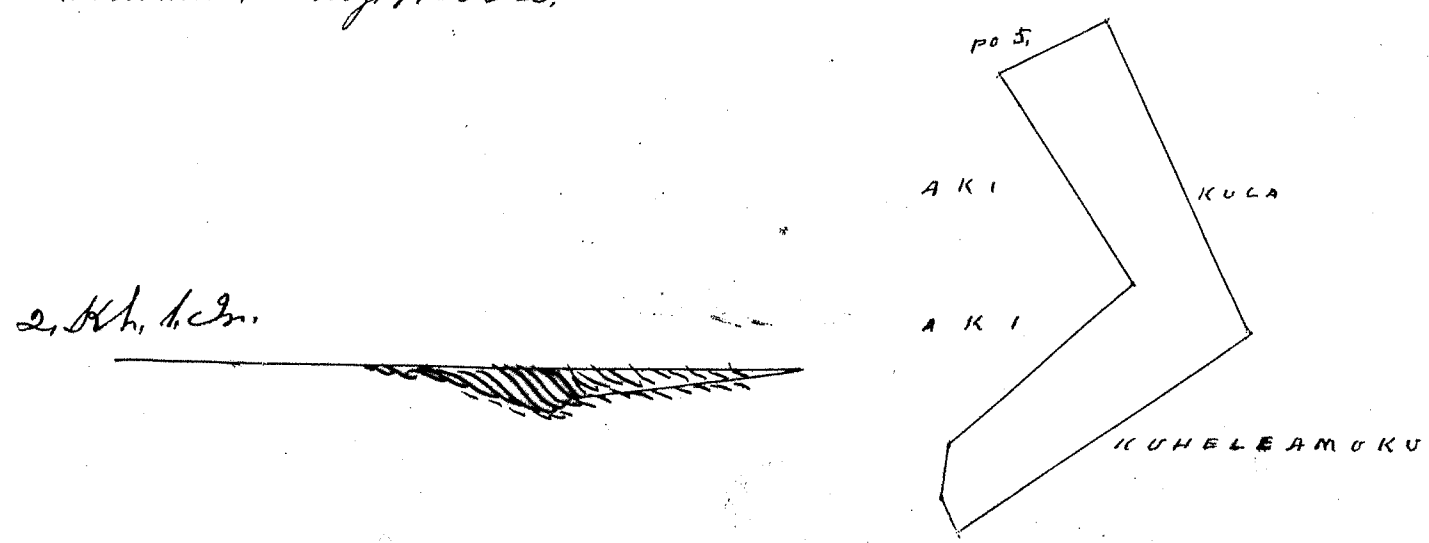

Uku Pau Loa p 4.
W. L. Lee
G. M. Robertson
J. H. Smith
S. Kekaulahao

Honolulu 16 Oct 1852.

Kolu 4427. Kamakahiwi

Mahee Maui.

Apana I Ihi. Nahe I E hoomaka ke ana ma ke Pihikihina o keia, e pihikihina ma Puhitaka
Heem. 60 1/2; Kom. 300 Kh. ma Kula, Ak. 62; Kom. 2:2 Kh. ma ke Kaulahewa, Ak. 24; Hiki 47 Kh.
ma ke Kaulahewa, Ak. 39; Kom. 305 Kh. ma ke Kaulahewa, Ak. 31 1/2; Hiki 28 Kh. ma ke Poalima
Ak. 59; Kom. 48 Kh. ma ke Poalima, Kom. 31 1/2; Kom. 38 Kh. ma ke Poalima, Ak. 39; Kom. 98
Kh. ma ke Kaulahewa, Ak. 59 3/4; Hiki 110 Kh. ma ke pali; Kom. 59; Hiki 257 Kh. ma ke Puhitaka
Haka, Heem. 61 1/2; Hiki 176 Kh. ma ke Puhitaka, Kom. 11 3/4; Kom. 40; Kh. ma ke Puhitaka Kom. 74
Hiki 351 Kh. ma ke Puhitaka, a hiki ma ke Kahi i hoomaka; a maloko via anapuni
132/100 Eka.

Apana II Ua haalele via no Kamakahiwi;

Apana III. Ihi. Kolia. E hoomaka ke ana ma ke Pihikihina o keia, Ak. 59 3/4; Kom.
122 Kh. ma ke Konoheki, Kom. 38; Kom. 55 Kh. ma ke Konoheki, Kom. 59 3/4; Hiki 122 Kh.
ma Konoheki; Ak. 38; Hiki 55 Kh. ma Konoheki a hiki i Kahi i hoomaka; a maloko via
anapuni 1/100 Eka.

Apana IV Ua haalele via;

Apana V Ihi. Kapuna. E hoomaka ke ana ma ke Pihikihina o ke Kaulahewa.
Heem. 61 3/4; Kom. 239 Kh. ma Kaulahewa, Ak. 64 1/4; Hiki 277 Kh. ma Kula, Kom. 24 1/4; Hiki
170 Kh. ma Kamakahiwi, Kom. 44 1/2; Kom. 136 Kh. ma Hoanaepu, Kom. 52 1/2; Kom. 126 Kh.
ma Poalima, a hiki ma Kahi i hoomaka; a maloko via anapuni; 5/100 Eka.

Apana VI Ihi. Lauhuc.

E hoomaka ke ana ma ke Pihikihina o keia, Kea pahu i lua o ke aoao Hina. Kaula
heem. 61 3/4; Kom. 109 Kh. ma Kaulahewa, Ak. 28 3/4; Kom. 100 Kh. ma Poalima, Ak. 60; Hiki
119 Kh. ma ke Kaulahewa, Kom. 20; Hiki 65 Kh. ma ke Kaulahewa, a hiki ma Kaulahewa ma
a maloko via anapuni; 12/100 Eka.

John S. Lowry.
Ma ana aina

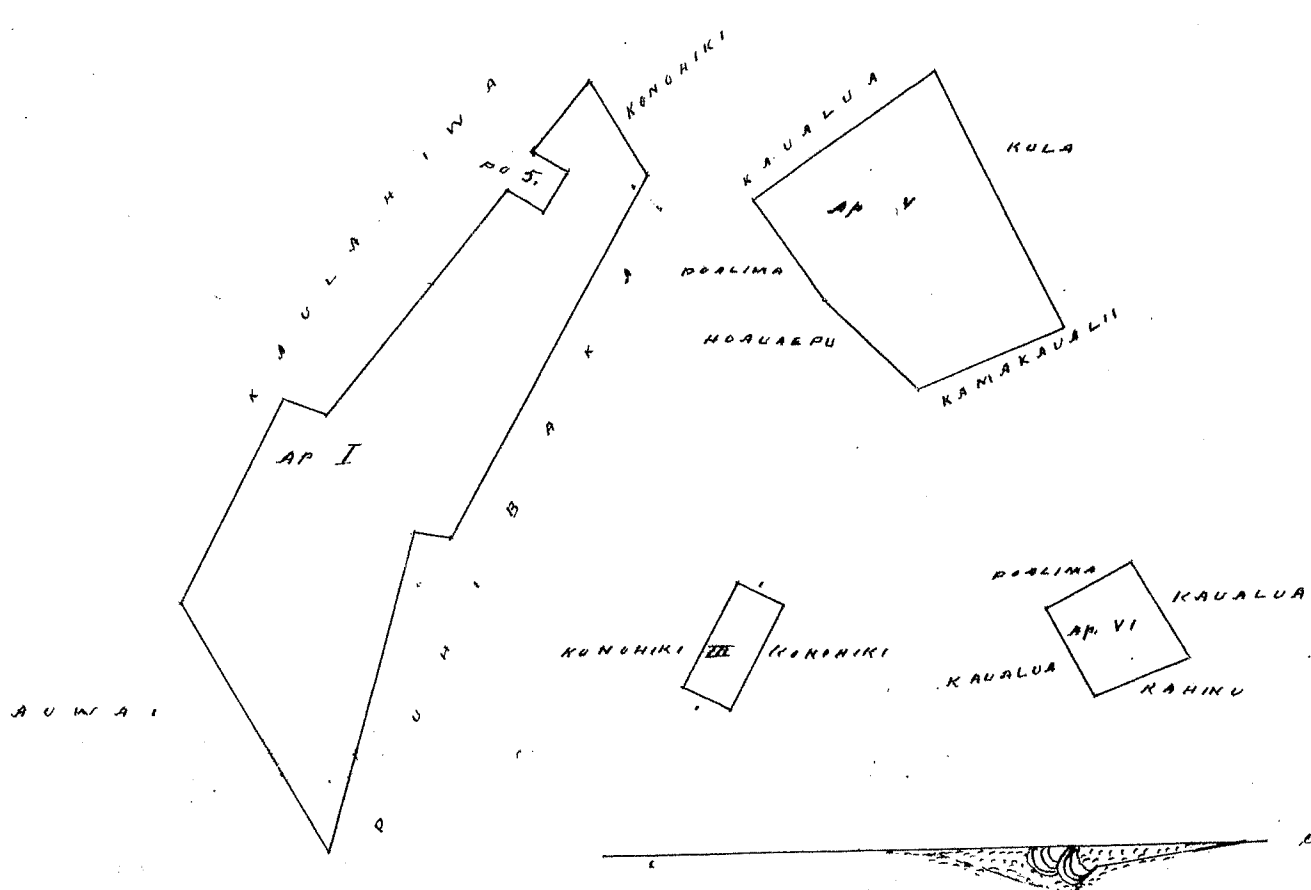

1. 32
6
59
12
2.09

Uku Pau Loa p 6
W. L. Lee
G. M. Robertson
J. H. Smith
S. Kekaulahao

Honolulu 16 Oct 1852

Hele 405 Koaueapu

Waivee Maui

Ili Hoolili E hoomaka ke ana ma ke Pihia Akau. Karkaa, Ak. 50 1/4. Hiki 55 Kh ma
 ke Kaulua, Hem. 27 1/2. Hiki 140 Kh ma ke Pualima, Ak. 63 1/4. Hiki 109 Kh ma ke Pualima
 Ak. 22. Kom. 164 Kh. ma ke Pualima. Ak. 44 1/2. Hiki 136 Kh ma ke Kamakawi,
 Hem. 80 Hoi 146 Kh. ma ke Kamakawali, Hem. 38 1/2. Hiki 103 Kh. ma ke Kamakawali
 Hem. 48 1/4 Kom. 52 Kh. ma ke Kamakawali, Hem. 34. Hiki 121 Kh. ma ke Kamakawali
 Hem. 41. Hiki 252 Kh ma ke Kuhuokaulani, Hem. 57 1/4. Hiki 118 Kh. ma ke Kuhuok-
 aulani, Hem. 37 1/4 Kom. 668 Kh. ma ke Karkaa, Ak. 42 3/4. Kom 151 Kh. ma ke
 Karkaa, Ak. 36. Kom. 409 Kh. ma ke Karkaa, a hiki ma kahi i hoomaka i
 a maloko via anapuni, 29/100 Eka.

Waivee July 7, 1852.

John S. Gower.

Mea ana aina

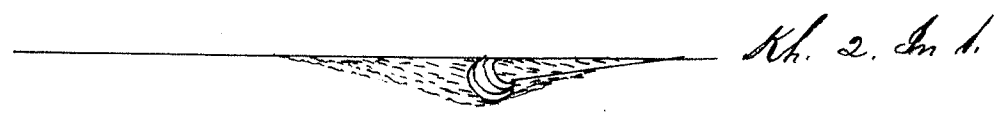
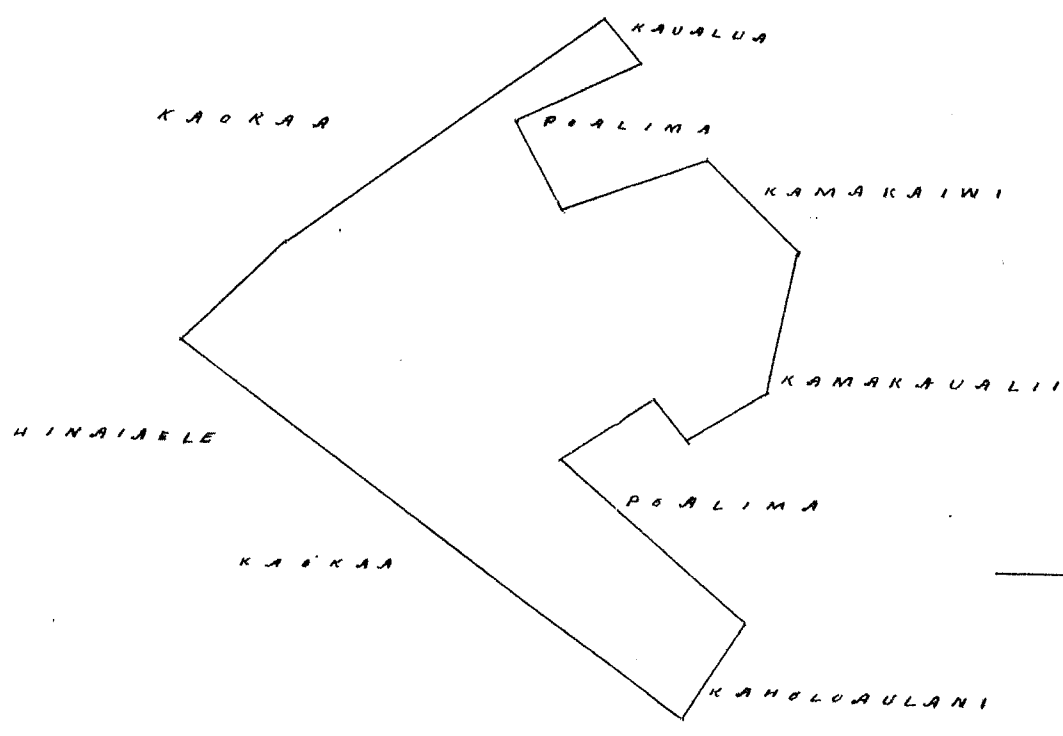

Uka Pau Loa # 6.

- W. H. Lee
- G. M. Robertson
- H. Smith
- J. Kekaulaoo

Honolulu 16. Oct. 1852.

Hele 3507 Koaueapu

Waivee Maui

Apana I Ili o Waianuanu E hoomaka ke ana ma ke Pihia Akau hikiina o Pimawaa
 Hem. 78. Hiki 399 Kh. ma Kula, Ak. 57 1/2. Hiki 303 Kh. ma Kula, Ak. 84. Kom. 164 Kh
 ma ke Pualima, Ak. 75 1/2. Kom. 251 Kh. ma Hale, Ak. 77 1/2. Kom. 112 Kh. ma Pualima
 Ak. 2 1/2. Kom. 49 Kh. ma Pualima, Ak. 57 1/2. Kom. 223 Kh. ma Pualima, Hem. 8 1/2
 Hiki 362 Kh. ma Pimawaa, a hiki ma kahi i hoomaka i a maloko via ana puni 1 2/10 Eka.

Apana II Ili o Hoomakaua, E hoomaka ke ana ma ke Pihia Akau hikiina o Kula, Hem. 50 1/2,
 Hiki 115 Kh. ma Kula, Hikiina 383 Kh. ma Anwai, Ak. 47. Hiki 165 Kh. ma Anwai,
 Ak. 22. Kom. 121 Kh. ma Pualima, Hem. 73 1/4. Kom. 570 Kh. ma Pali, a hiki ma kahi
 i hoomaka i, maloko via anapuni, 85/100 Eka.

Mahale II Ili o Hoomakaua, E hoomaka ke ana ma ke Pihia Akau hikiina o Kula, Ak. 47,
 Hiki 225 Kh. ma Anwai, Hem. 73 1/2. Kom. 215 Kh. ma Pali, Hem. 24 1/2. Hiki 95 Kh. ma
 Pualima, a hiki ma kahi i hoomaka i a maloko via anapuni 20/100 Eka.

Waivee, July 20, 1852

John S. Gower

Mea ana aina

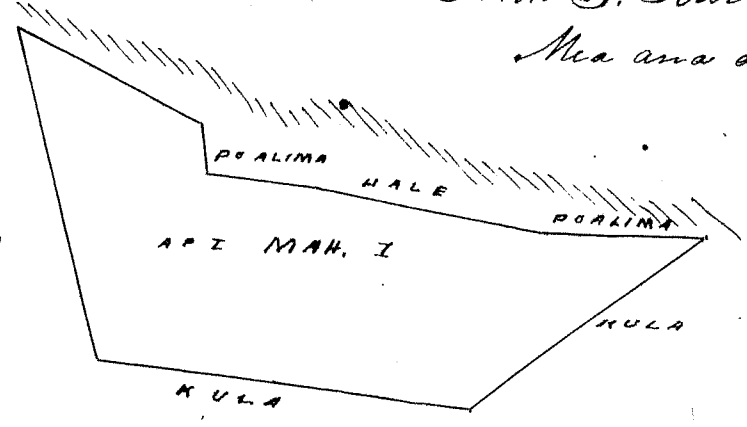
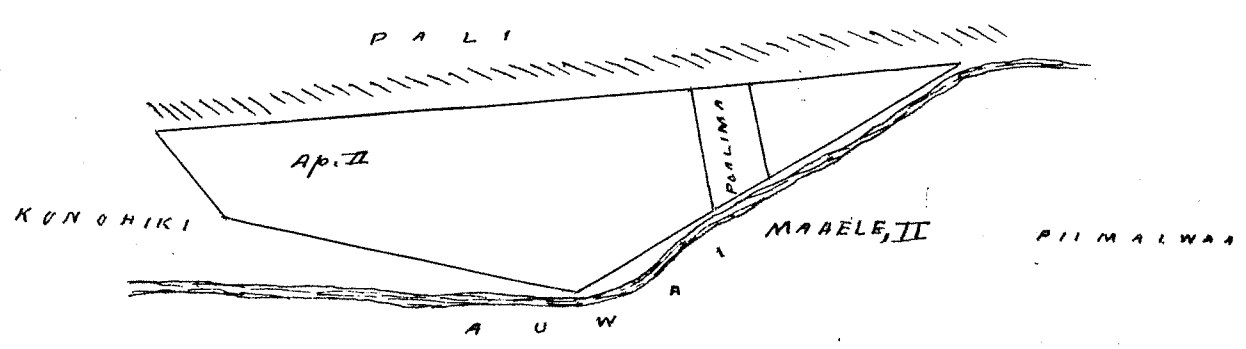

1 lot containing

Uku Pau Loa # 6
W. Lee
G. M. Robertson
M. Smith
J. Kekaulahao

Honolulu 16 Oct 1852.

Helu 3770 & 4424 Mauka

Waiau Maui

Apana I Ili, Koiaki, E hoomaka ke ana ma ke Pihikema o Keia, e pili ana me ke Pihikema Hikina. Kauhelaumoku, Ak. 69 3/4, Hik 71 Kh. ma Poalima, Ak. 60, Hik 81 Kh. ma Kaaamaku, Ak. 30 1/2 Kom. 62 Kh. ma Kapihē Hem. 60, Kom. 68 Kh. ma ke Pahi Ak. 30 1/2 Kom. 68 Kh. ma Palahi Pahi, Ak. 60, Hik 68 Kh. ma Pahi Ak. 30 1/2, Kom. 202 Kh. ma Kapihē, Hem. 82 Kom. 156 Kh. ma ke Anakalea, Hem. 30, Hik. 372 Kh. ma ke Kauhelaumoku, a hiki ma kahi i hoomaka i a maloko oia anapuni 43/100 Eka.

Apana II Ili Koiaki, E hoomaka ke ana ma ke Pihikema o Keia, e pili ana me Kahawai Hem. 36 1/2, Hik 77, Kh. ma Kula, Hem. 48 3/4, Kom. 219 Kh. ma ke Kapihē Hem. 71 3/4 Kom. 215 Kh. ma Poalima, Ak. 28 Kom. 56, Kh. ma Poalima, Ak. 56 3/4 Hik 412 Kh. ma Kahawai, a hiki ma kahi i hoomaka i a maloko oia anapuni 36/100 Eka.
Wailuku, July. 16, 1852.

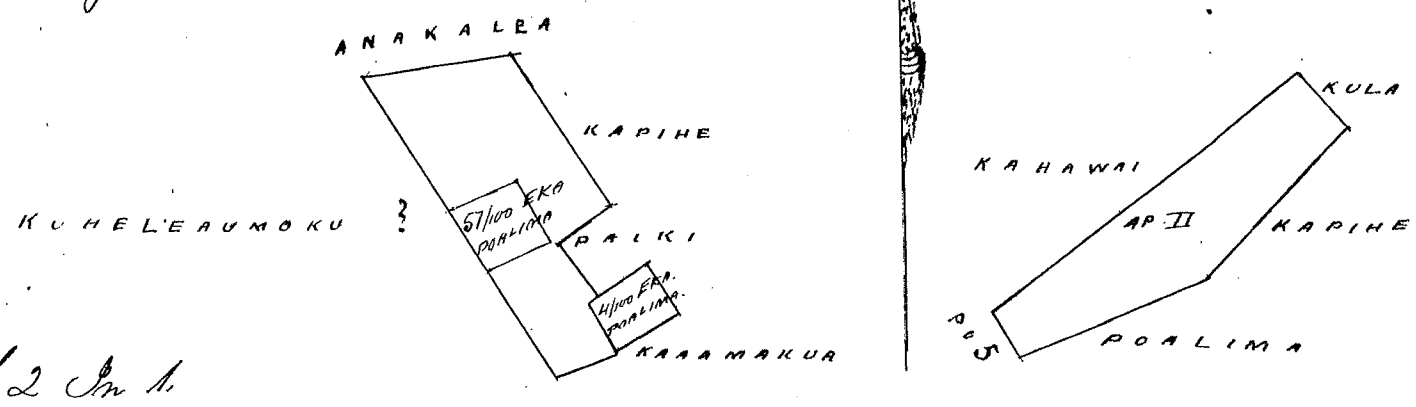

John S. Gower,
Ma ana aina

M. 2 In 1.

Uku Pau Loa # 5
W. Lee
G. M. Robertson
M. Smith
J. Kekaulahao

Honolulu 16 Oct 1852.

Helu 4295 Kapihē

Waiau Maui

Apana I Ili, Koiaki, E hoomaka ke ana ma ke Pihikema o Keia, e pili ana me Kahawai o Keia, Ak. 27, Kom. 208 Kh. ma Kaaamaku, Hem. 74 Kom. 129 Kh. ma Poalima, Hem. 69, Kom. 110 Kh. ma Anakalea, Hem. 17 3/4, Hik 82 Kh. ma Poalima, Hem. 69 1/4, Kom. 80 Kh. ma ke Poalima Hem. 69, Kom. 124 Kh. ma Anakalea, Ak. 22 1/2, Kom. 80 Kh. ma Poalima Hem. 30 1/2 Hik 323 Kh. ma Anakalea, Ak. 54, Hik 421 Kh. ma Kauhelaumoku, a hiki ma kahi i hoomaka i a maloko oia anapuni, 1/10 Eka.

1.10
15
24
1.149

Apana II Ili, Koiaki, E hoomaka ke ana ma ke Pihikema o Keia, e pili ana me Hikina o Mauka, Hem. 48 3/4, Kom. 219 Kh. ma ke Mauka, Hem. 35 1/2, Hik 72 Kh. ma Kauhelaumoku, Ak. 49, Hik 220 Kh. ma Pahi, Ak. 35 1/2, Kom. 74 Kh. ma Pahi, a hiki ma kahi i hoomaka i a maloko oia anapuni, 15/100 Eka.

Apana III Ili, Koiaki, E hoomaka ke ana ma ke Pihikema o Keia, e pili ana me Kahawai o Mauka, Apana II Ak. 49 Kom. 63 Kh. Hem. 26, Hik 204 Kh. ma Poalima Hem. 68 1/2, Kom. 143 Kh. ma Pahi, Ak. 21 1/2, Kom. 42 Kh. ma Kauhelaumoku, Ak. 5, Hik 103, Kh. ma Kauhelaumoku, Ak. 62, Hik 81 Kh. ma Kahawai, a hiki ma kahi i hoomaka i a maloko oia anapuni, 24/100 Eka.

Wailuku, July, 10, 1852

John S. Gower,
Ma ana aina

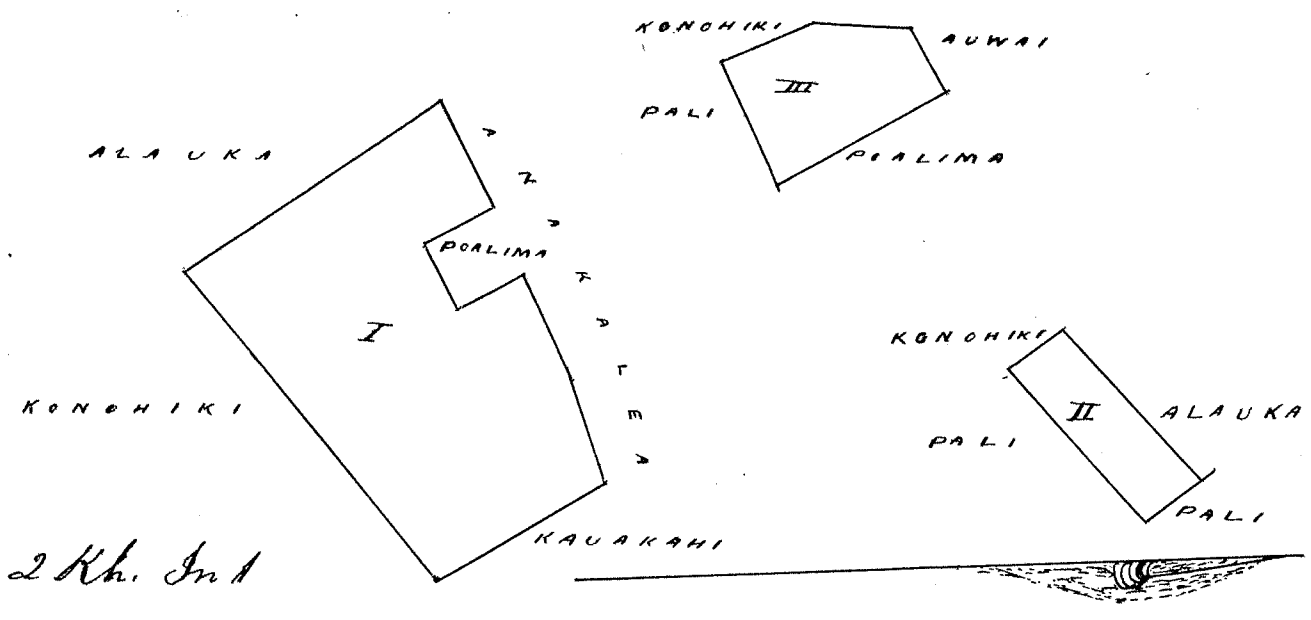

Uku Pau Loa § 5.
 W. L. Lee
 F. M. Robertson
 W. Smith
 J. Kekaulaha

Honolulu, 16. Oct. 1852

Heleu 4426 Kahinu I

Waiehe Hawaii

Apuna I. Ili. Kalipahu. E hoomaka ke ana ma ke Piki Hihina Hema o Kawalua, Ak. $21\frac{1}{4}$ Kom. 115 Kh. ma Kawalua, Ak. 20 Kom. 105 Kh. ma Kamakahi, Ak. $24\frac{1}{4}$ Kom. 79 Kh. ma Kawalua, Ak. $67\frac{1}{4}$ Nih 70 Kh. ma Keawe, Ak. $55\frac{1}{4}$ Nih 538 Kh. ma Keawe, Ak. $39\frac{1}{2}$ Kom. 125 Kh. ma Keawe, Ak. $75\frac{1}{2}$ Nih, 200 Kh. ma Pi. Kom. 52 Nih 57 Kh. ma Poalima, Ak. 56 Nih 202 Kh. ma Paahaa, Kom. 2 Nih 194 Kh. ma Pali, Kom. 64 Kom. 363 Kh. ma Poalima, Kom. $37\frac{1}{2}$ Nih 202 Kh. ma Poalima Kom. 60 Kom. 295 Kh. ma Auwai, Kom. 63 Kom. 281 Kh. ma Konghiki, a hiki ma kahi hoomaka i a maloke via anapuni $2\frac{2}{10}$ Eka,

Apuna I Poalima i loko. E hoomaka ke ana ma ka pahu hope, o Kila Kulaana, Ak. 11 Kom. 111 Kh. a hiki ma ke Piki Kila, Ak. $38\frac{1}{4}$ Kom. 82 Kh. Kom. $53\frac{1}{2}$ Kom. 132 Kh. Kom. $38\frac{1}{4}$ Nih 82 Kh. Ak. $53\frac{1}{2}$ Nih 132 Kh. a hiki ma ka pahu mua, a maloke via Poalima $\frac{1}{10}$ Eka,

Apuna II Ili Kapahukawila E hoomaka ke ana ma ke Piki Hema o Kila, Ak. 57 Nih 57 Kh. ma Kaulaana, Kom. $57\frac{1}{4}$ Nih 120 Kh. ma Kaulaana, Kom. $31\frac{1}{2}$ Kom. 84 Kh. ma Kaulaana, Ak. 56 Kom. 132 Kh. ma Kaulaana, a hiki ma ka pahu mua a maloke via anapuni, $\frac{1}{10}$ Eka,

Wailuku July. 9. 1852

John S. Gower.
 Mea ana aina

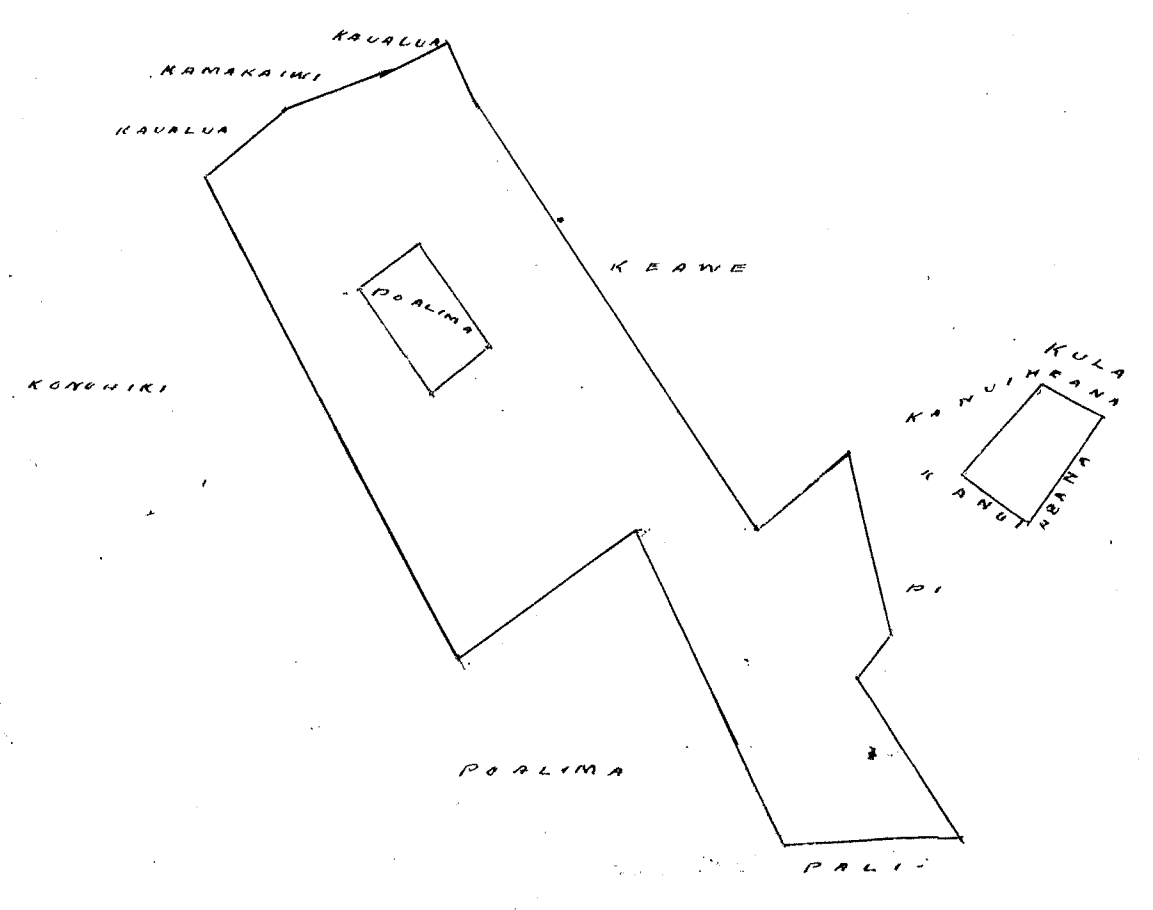

Kh. 2 In 1

Uku Pau Loa #6

W. Lee
G. M. Robertson
W. Smith
J. Kekaulakao

Honolulu 16. Oct. 1852

Heleu 3517 Kanihihana

Waihee Meaua

Apana I. & II Ihi. Kapahukauwila. E hoomaka ke ana ma ke Pihī Heikina o Keia, e pili ana ma ke Pihī Heima o Kaulahiwa. Hem. $49\frac{1}{2}$ Kom. 307 Kh. ma ka auwai, Ak. $43\frac{3}{4}$ Kom. 304 Kh. ma ka Keawe. Hem. $54\frac{1}{2}$ Kom. 62 Kh. ma ka Keawe, Hem. 36 Kom. 248 Kh. ma ka Poalima, Hem. 67. Hiki 199 Kh. ma ka Poalima, Hem. $47\frac{1}{2}$ Hiki. 74 Kh. ma ka Keawe, Hem. 28 Kom. 183 Kh ma ka auwai, Ak. $62\frac{1}{2}$ Kom. 275 Kh. ma ka Poalima Hem. 46 Kom. 41 Kh. ma ka Poalima, Ak. $33\frac{1}{2}$ Kom. 123 Kh. ma ka Poalima, Ak. 57 Hiki 57 Kh. ma ka Kahinu, Ak. $24\frac{1}{2}$ Hiki. 287 Kh. ma ka Pali; Ak. 8 Hiki. 268 Kh. ma ka pali; Hem. $51\frac{3}{4}$ Hiki. 130 Kh. ma ka Kahinu, Ak. $31\frac{1}{2}$ Hiki 84 Kh. ma Kahinu, Ak. 56 Kom. 132 Kh. ma ka Kahinu, Ak. $7\frac{1}{2}$ Hiki 296 Kh ma ke Kula, Hem. $59\frac{1}{2}$ Hiki 174 Kh. ma Kula; Hem 40 Hiki 457 Kh. ma ka Kaulahiwa, Hem $77\frac{3}{4}$ Kom. 80 Kh. ma ka Poalima Hem. 36 Hiki 65 Kh. ma ka Poalima, Ak. $77\frac{3}{4}$ Hiki 80 Kh ma Poalima, Hem. 31 Hiki 140 Kh ma ka Kaulahiwa, a hiki ma kahi i hoomaka i a maloko via auwai, $3\frac{15}{100}$ Eka.

Poalima E hoomaka ke ana ma ke Pihī Akau. o Keia Kuleana, Hem. $42\frac{1}{2}$ Hiki. 213 Kh. a hiki ma ke Pihī Akau o Keia, Hem. 50 Hiki 129 Kh. Hem. 42 Kom. 57 Kh. Ak. 50 Kom. 129 Kh. Ak. 42 Hiki. 57 Kh. a hiki ma kahi i hoomaka i a maloko via Poalima $7/100$ Eka.

Apana III Ihi. Nahe. Wa haalele via.

John S. Fowler.
Mea ana aina

Waiuku Aug. 12, 1852.

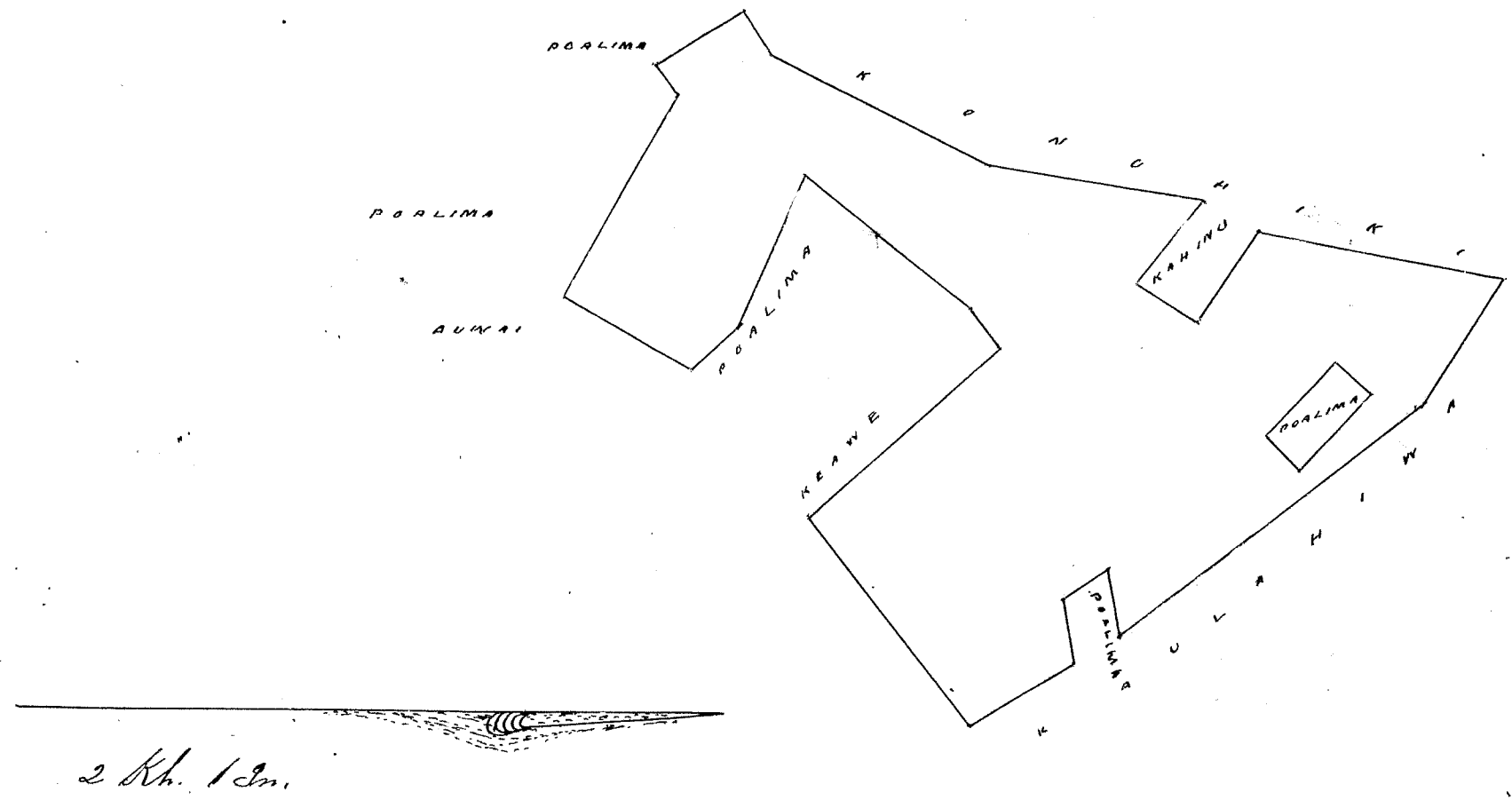

Uku Pau Loa #7

W. Lee
G. M. Robertson
W. Smith
J. Kekaulakao

Honolulu. 16. Oct. 1852

Apana I. Ihi. Kaholoaulani. E hoomaka ke ana ma ke Pihī Puhou. (Hema)
 Ak. 29 1/2. Kom. 240 Kh. ma ke Puhou, Kom. 38 1/2. Kom. 20 Kh. ma ke Poalima. Ak. 52.
 Kom. 25 Kh. ma ke Poalima, Ak. 43 3/4. Hiki 45 Kh. ma ke Poalima, Ak. 47 1/2. Kom. 108 Kh.
 ma ke Puhou. Ak. 59 3/4. Kom. 87 Kh. ma ke Poalima, Kom. 45 1/2. Kom. 183 Kh. ma ke Aunai, Kom
 57 Hiki 163 Kh. ma ke Kaunaka, Kom. 45. Hiki 116 Kh. ma ke Poalima Kom. 55 Hiki 77 Kh.
 ma ke Kawahua, Ak. 62. Hiki 118 Kh. ma ke Kaunaka, Kom. 43 1/2. Hiki 75 Kh. ma ke Kaunaka
 Ak. 57 Hiki 85 Kh. ma ke Keawe, a hiki ma kahi i hoomaka i a maloko via anapuni, 3/4 Eka

Apana II & III Ihi. Hoalani, & Hoolele E hoomaka ke ana ma ke Pihī Kihina.
 Hoawaepe Ak. 57 1/2. Kom. 257 Kh. ma ke Hoawaepe, Kom. 65 3/4. Kom. 88 Kh. ma Poalima
 Ak. 26 1/4. Kom. 106 Kh. ma Kamakaualii. Ak. 41 1/4. Hiki 285 Kh. ma Kula, Kom. 42 1/2.
 Hiki 160 Kh. ma ke Konoehiki, Kom. 47 1/4. Kom. 60 Kh. ma ke Konoehiki, Kom. 47. Hiki 212 Kh.
 ma Konoehiki, Kom. 20. Kom. 124 Kh. ma ke Konoehiki, a hiki ma ka pahu mua, a maloko
 via anapuni, 79/100 Eka,

Kailuku July 10, 1852

John S. Gover.

Mea ana aina

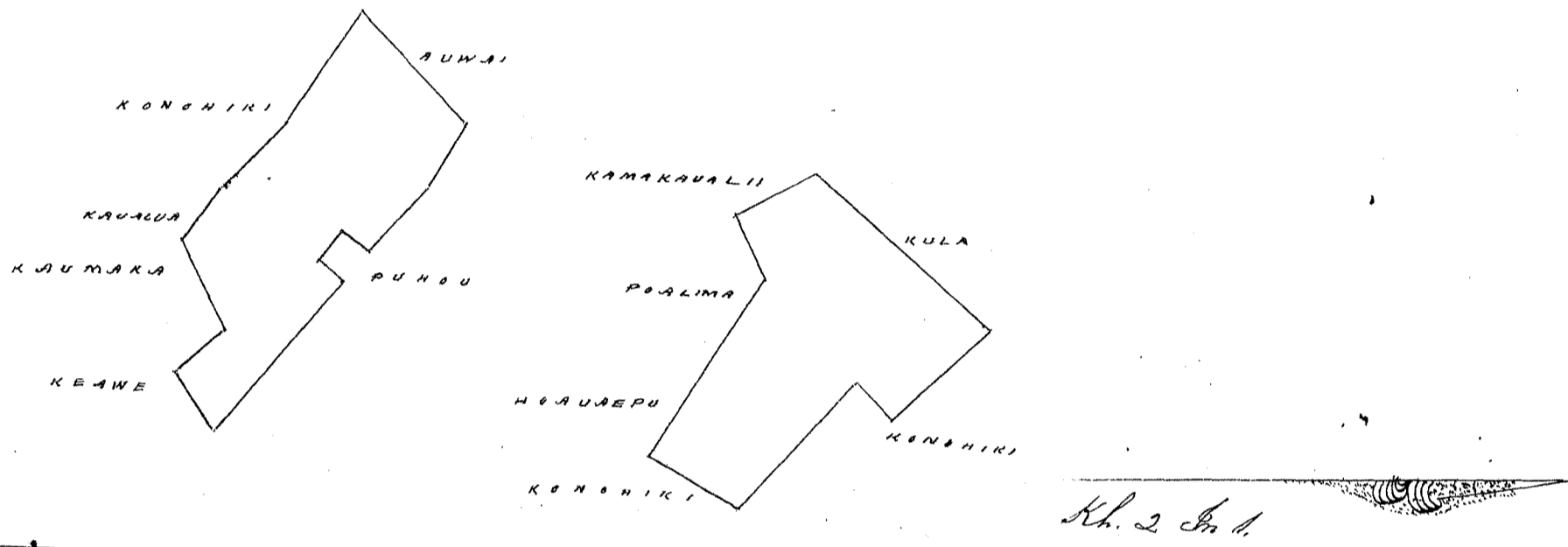

Uku Pau Loa \$5
 K. H. Lee
 G. W. Robertson
 M. Smith
 J. Kekaulahao

Honolulu 16 Oct 1852

Maahale I. Ihi Puhou. E hoomaka ke ana ma ke Pihī Akau. o keia, mai ke Pihī Komo-
 hana Kima. Papohaku Kom. 70 1/4. Kom. 140 Kh. Kom. 38 1/2. Hiki 177 Kh. ma ke Kahikihua
 Kom. 55 Kom. 83 Kh. ma ke Lauhoo, Ak. 35. Kom. 184 Kh. ma ke Poalima Ak. 60. Hiki 89
 Kh. ma ke Makale, a hiki ma kahi i hoomaka i a maloko via anapuni 16/100 Eka.

Maahale II E hoomaka ke ana ma ke Pihī Komoehana Kima, o Papohaku, ke Pihī Komoehana
 o keia, Kom. 84 1/4. Hiki 66 Kh. ma Papohaku, Ak. 54 1/4. Hiki 545 Kh. ma Papohaku Kom. 29.
 Hiki 164 Kh. ma ke Poalima, Kom. 66 1/2. Kom. 217 Kh. ma Lauhoo, Kom. 51. Kom. 269 Kh. ma ke
 Lauhoo, Ak. 39 1/4. Kom. 69 Kh. ma ke Poalima, Kom. 52 1/2. Kom. 90 Kh. ma ke Poalima
 Ak. 34 1/4. Kom. 111 Kh. ma Konoehiki, a hiki ma kahi i hoomaka i, a maloko via anapuni, 3/4 Eka.

Maahale III E hoomaka ke ana ma ke Pihī Komoehana o keia, a pili ana ma Poalima
 a ma Papohaku, Ak. 54 1/4. Hiki 61 Kh. ma ke Papohaku, Ak. 59. Hiki 107 Kh. ma ke Poalima
 Kom. 18 1/2. Hiki 100 Kh. ma ke Poalima, Kom. 65 1/2. Kom. 66 Kh. ma Konoehiki, o Opunui, Kom.
 31 3/4. Hiki 103 Kh. ma ke Konoehiki o Opunui, Kom. 66 1/2. Kom. 105 Kh. ma ke Lauhoo,
 Ak. 24. Kom. 180 Kh. ma ke Poalima, a hiki ma kahi i hoomaka i, a maloko via anapuni
 23/100 Eka,

John S. Gover

Mea ana aina

Wailuku July 7 1852.

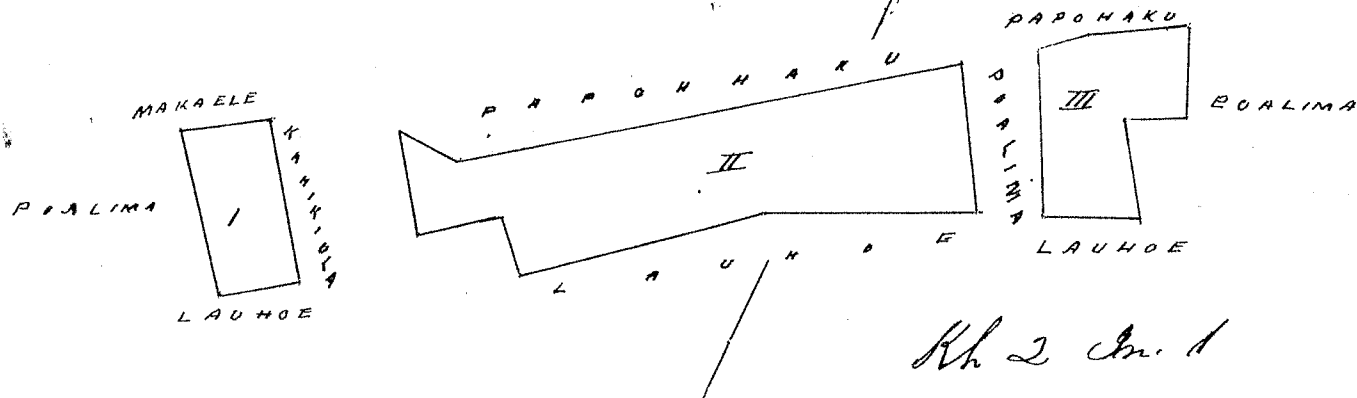

Uku Pau Loa # 6
 W. L. Lee
 G. M. Robertson
 J. H. Smith
 J. Kekaulaha

Honolulu 16 Oct 1852

Kalu 4010 Hinaiale I

Kaiee Maui

Apana I & II Iki. Hōlile & Kapahukawila. E hōmaka ke ana ma ke Kahi Hōkima o Keia, e pili ana me Hoanapuun. Hem. 52° Hōk 214 Kh. ma ke Kaokaa, Hem. 68 3/4° Hōk 296 Kh. ma ke Kaokaa, Hem. 43° Kom. 117 Kh. ma ke Poalima, Hem. 47 1/4° Hōk 45 Kh. ma Poalima, Ak. 43 1/2° Hōk 125 Kh. ma ke Poalima, Hem. 44 1/4° Hōk 53 Kh. ma ke Kaokaa, Hem. 52° Kom. 252 Kh. ma ke auwai, Ak. 41 3/4° Kom. 86 Kh. ma ke Poalima, Ak. 75 1/2° Hōk 78 Kh. ma ke Poalima Ak. 54 1/2° Kom. 215 Kh. ma ke Poalima, Hem. 29 3/4° Kom. 80 Kh. ma ke Poalima, Hem. 53 1/4° Hōk 82 Kh. ma ke Poalima, Hem. 39 1/2° Kom. 133 Kh. ma ke Poalima, Hem. 53 Hōk 196 Kh. ma ke Poalima, Hem. 41 3/4° Kom. 115 Kh. ma ke auwai, Komohana pouni; 80 Kh. ma ke auwai, Ak. 37 3/4° Kom. 130 Kh. ma ke Poalima, Hem. 50° Kom. 46 Kh. ma ke Poalima Ak. 43° Kom. 88 Kh. ma ke Kaokaa, Ak. 42° Hōk 163 Kh. ma ke Poalima, Ak. 37 1/4° Kom. 140 Kh. ma ke Poalima, Ak. 33 1/4° Hōk 63 Kh. ma ke Poalima, Ak. 33 1/4° Kom. 103 Kh. ma ke Poalima, Ak. 35 1/2° Hōk 164 Kh. ma ke Hoanapuun, a hiki ma ke pahu mwa, a maloko oia anapouni, 1/2. E ka,

Wailuku, July 7, 1852

John S. Lewis.

Mia ana aine

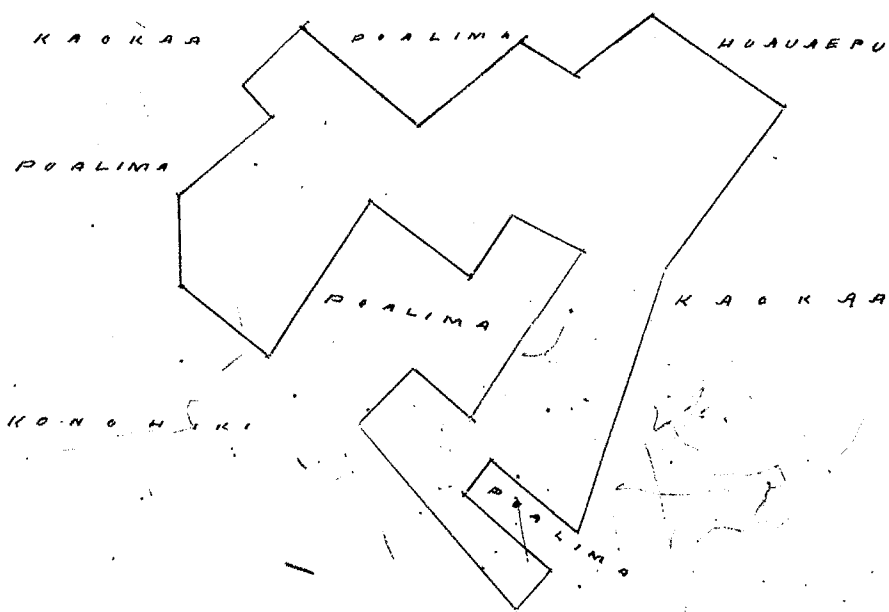

Uku Pau Loa # 6
 W. L. Lee
 G. M. Robertson
 J. H. Smith
 J. Kekaulaha

Honolulu, 16 Oct. 1852.

Hem. 35 1/2. Nih 56 Kh. ma ko Laukapulu, Ak. 51 3/4. Nih 297 Kh. ma ko Komohiki Ak. 39. Kom 125. Kh. ma Pahale Kula, Hem. 38. Kom 294 Kh. ma ko Pali; a hiki ma kahi i hoomakahi, a maloko oia Anapuni, 28/100 Eka.
Apana III Aole ana keia I loko o ke keai

Wailuku, July. 7, 1852.

John S. Gowen,
Ma ana aina

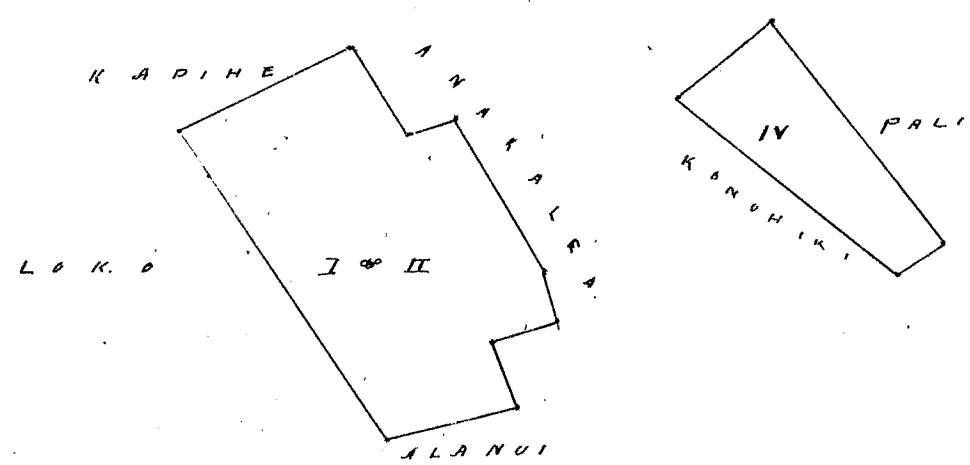

Wm Pau Lee
W. Lee
G. M. Robertson
W. Smith
C. Kekaulaao

Honolulu, 16, Oct. 1852.

Kelu 4377 Keawe

Waiau Maui

Apana I. Ili o Halapahu Chomaka ke ana ma ke Kihikomoana i pili ana ma ko Kaulawa, Ak. 57. Nih 279 Kh. ma ko Auwai, Ak. 59. Nih 221 Kh. ma ko Kamaka, Hem. 39 1/2. Nih 24 Kh. ma ko Pi, Ak. 54 3/4. Nih. 71 Kh. ma ko Pi, Hem. 39 1/2. Nih. 125 Kh. ma ko Kahinu Hem. 55 3/4. Kom. 538 Kh. ma ko Kahinu, Hem. 67 1/4. Kom. 70 Kh. ma ko Kahinu, Ak. 24 1/2 Kom. 154 Kh. ma ko Kahinu, a hiki ma kahi i hoomakahi a maloko oia anapuni 85/100 Eka.

Apana II & III Ili o Kalaninuikehe, & Kapahu Kawila, Chomaka ke ana ma ke Kihikomoana o Kanuiehana, Ak. 43 3/4. Kom. 304 Kh. ma ko Kanuiehana Hem. 54 1/4. Kom. 62. Kh. ma ko Kanuiehana, Hem. 44 1/4. Nih. 251 Kh. ma ko Poalima, Hem. 54. Kom. 170 Kh. ma ko Poalima, Hem. 47 1/2 Nih. 74 Kh. ma ko Poalima, Ak. 49 1/2 Nih. 223 Kh. ma ko Poalima, a hiki ma kahi i hoomakahi a maloko oia Anapuni, 28/100 Eka.

Apana IV Ua ae mo Keawe e haalele i keia Apana

Wailuku, July, 7, 1852

John S. Gowen,
Ma ana aina

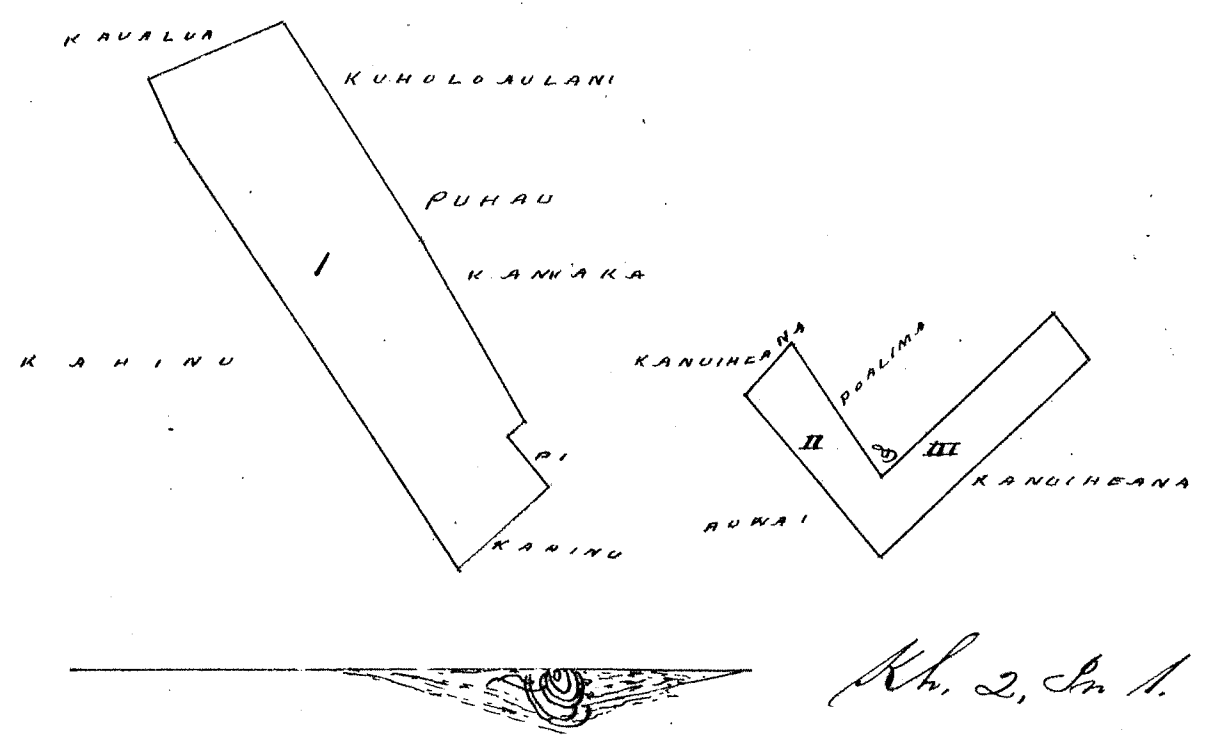

Kh. 2, In 1.

P. Lee
G. M. Robertson
J. H. Smith
J. M. Kaulahao

Honolulu 16 Oct 1852.

Heleu 5180 Kumaiohea

Kiimalu Hana Maui

Iki palapala huike i ke ana ana i ke Kahi aina Kuleana o Kumaiohea Heleu 5180 e waiho ana ma ke Ahupuaa o Kiimalu Hana, ma ke Kuleana o Hana, a ma ke Mookupuni o Maui.

E hoomaka ma ke Kahi Akau, Komohana o Paaimoku a e holo ana, Heleu 38° Komohana, 345 Kaulahao, e pili ana me Ahupuni, Heleu 45° Komohana 474 Kaulahao e pili ana me ke Ahupuni, Akau 37 1/2° Komohana 232 Kaulahao, e pili ana i ke Ahupuni Akau 48° Heleu 14,82 Kaulahao, e pili ana me Kaulaawa, Akau 41 3/4° Heleu 479 Kaulahao, e pili ana me Kaulaawa, Akau 57 1/4° Heleu 12,88 Kaulahao, a pili ana me Kaulaawa, Akau 71 1/2° Heleu 274 Kaulahao, e pili ana me Kaulaawa, Akau 50° Heleu 16,17 Kaulahao, e pili ana me Kaulaawa, Akau 43 1/4° Heleu 717 Kaulahao, e pili ana i ke Alanui Ahupuni, Akau 39° Heleu 661 Kaulahao e pili ana me ke Alanui Ahupuni, Akau 40° Heleu 4,20 Kaulahao, e pili ana me Kaulaawa. Heleu 63 1/2° Heleu 276 Kaulahao, e pili ana me Kaulaawa Heleu 30° Komohana 12,30 Kaulahao e pili ana me Heleu, Heleu 31 1/4° Komohana 709 Kaulahao, e pili ana me ke aina o Kaula o Kaulaawa, Akau 85 1/2° Komohana 0,96 Kaulahao, e pili ana me Kaulaawa, Heleu 70° Komohana 8,26 Kaulahao e pili ana me Kaula, Heleu 49° Komohana 850 Kaulahao, e pili ana me Kaula, Heleu 74 1/2° Komohana 9,10 Kaulahao, e pili ana me ke Ahupuni, Heleu 48 3/4° Komohana 1218 Kaulahao, e pili ana me ke Ahupuni, Heleu 45 1/4° Komohana 541 Kaulahao e pili ana me Paaimoku, a hiki i Kahi i hoomaka i Ka Ili Uonikumamaiawa Eka,

W. P. Alexander
Me a ana aina

E oki i ka aina o Miki penei, mai ke Kahi Heleu o Heleu aina e ana mai Heleu 30° Komohana 10,38 Kk. a hiki ma ke Alanui, alaila holo ma ke Alanui. Ak. 48° Komohana a kela aia, alaila ma ke no Kumaiohea. 17 1/100 Eka.

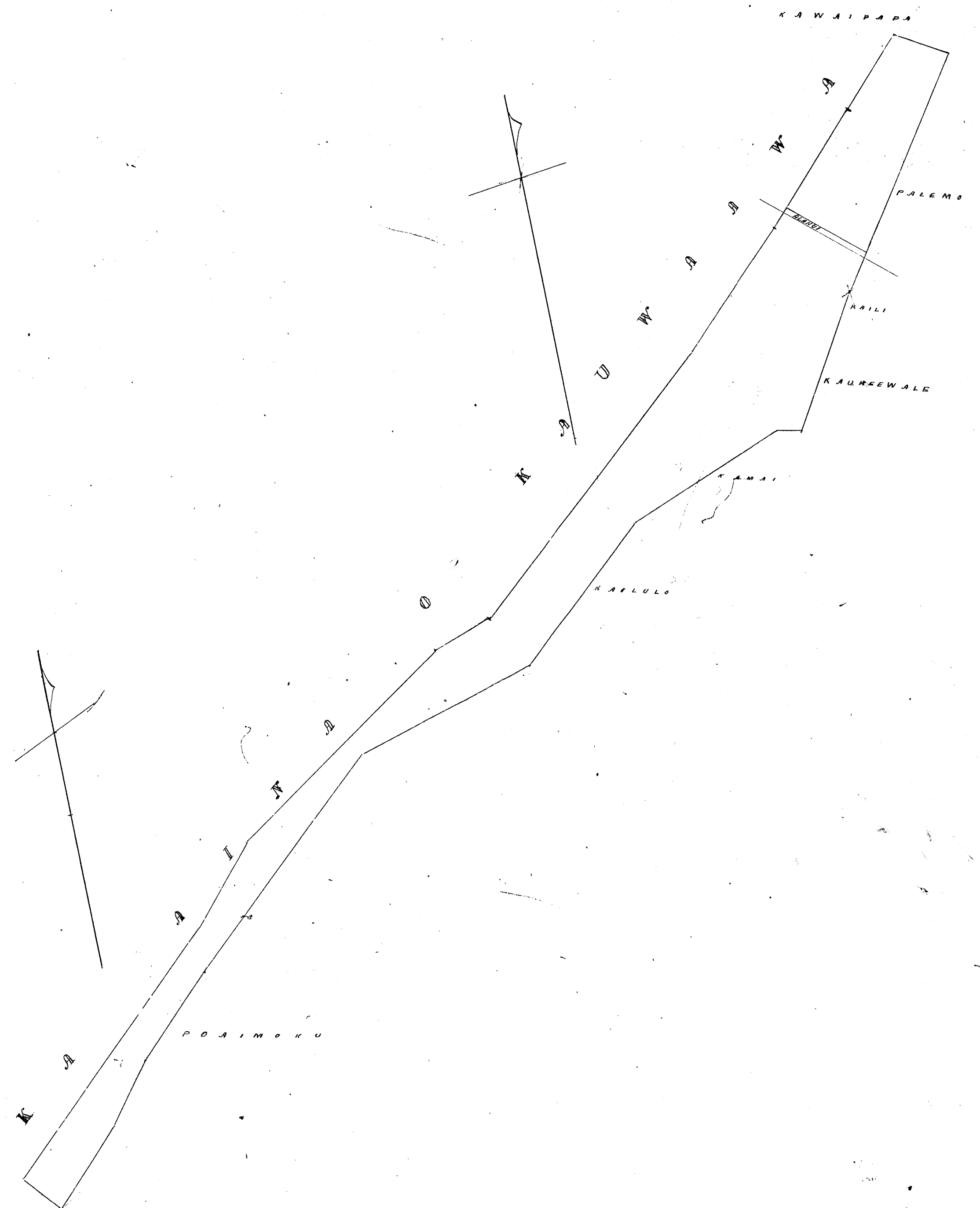

Uku Pau Loa # 8

W. L. Lee
 G. M. Robertson
 J. Kikaulahao
 J. H. Smith

Honolulu, 26, Oct. 1852.

Keolu 5174 Kaolulo

Palena Aana Maui

He palapala hoakaka i ke ana ana i kekahi aina Kulana. Kaolulo, e waiho ana ma ke ahupuaa o Palena, ma Aana Maui. E hoomaka ana ma kona kihi Akau Hikiina a e holo ana, Aema 49° Komohana, 850 Kaulahas, e pili ana me ke Kumaiahea Aem. 60 1/2 Hikiina 747 Kaulahas, e pili ana me ke Aupuni, Akau 41 1/3 Hikiina 587 Kaulahas, ma ke Kameniu, Akau 40° Komohana, 642 Kaulahas e pili ana me ke Kamai, a hiki i Kahi i hoomaka i Ka Ili Eka Eka Eka Roda a me Swakalua Roda

W. P. Alexander
Mea ana aina

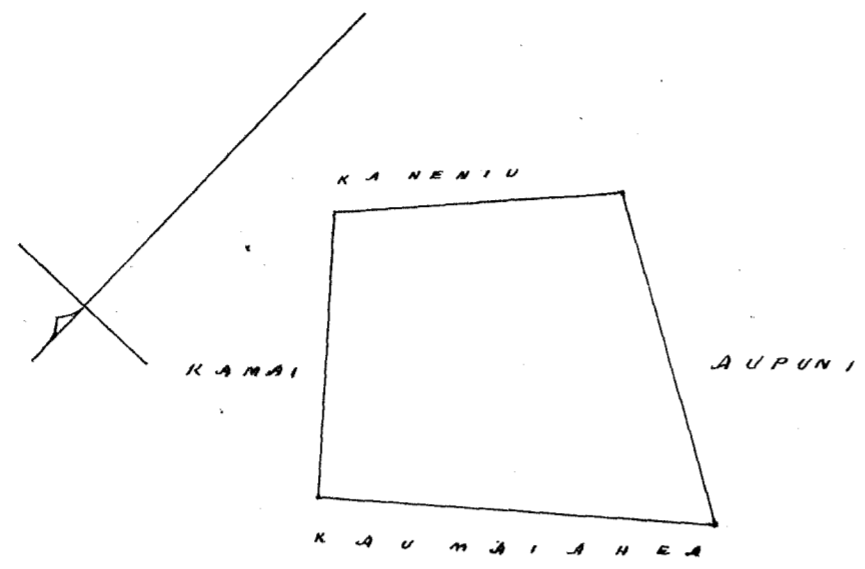

Uku Pau Loa # 5
W. L. Lee
G. M. Robertson
J. Kapaalahao
J. H. Smith

Honolulu 26 Oct 1852

Keolu 5186 Kamai

Palena Aana Maui

He palapala hoakaka i ke ana ana i kekahi apana aina Kulana. Kamai, Keolu 5186 e waiho ana ma ke ahupuaa o Palena, ma Aana Maui. E hoomaka ana ma ke kihi Aema, Mauka, kihi, e pili ana me ke Kameniu a e holo ana, Akau 40° Komohana 642 Kaulahas, e pili ana me ke Kaula Akau 70° Hikiina 826 Kaulahas, e pili ana me ke Kumaiahea, Aema 13 Hikiina 381 Kaulahas, e pili ana me ke Kawahewale, Aema 53° Komohana, 642 Kaulahas e pili ana me ke Kaili, a hiki i Kahi i hoomaka i Ka Ili Eka Eka a me Ewa Roda

W. P. Alexander
Mea ana aina

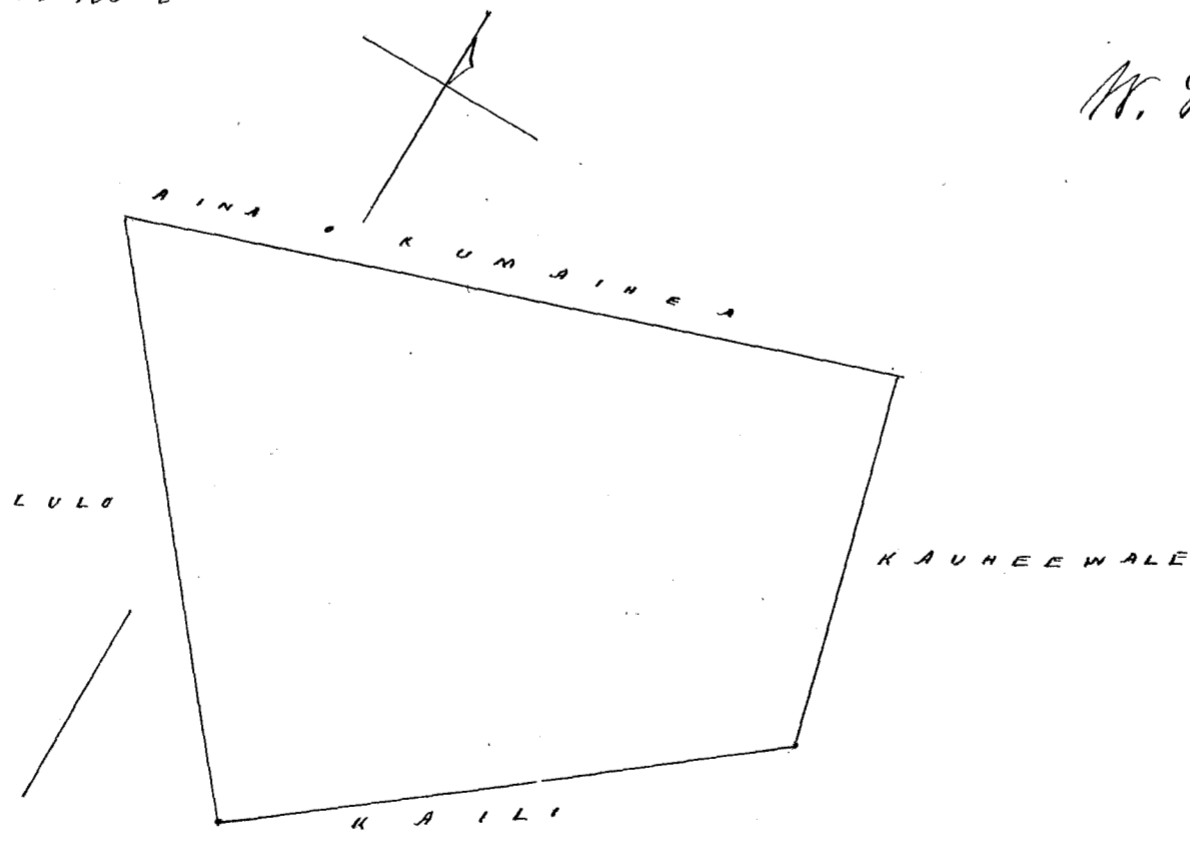

Uku Pau Loa # 5
W. L. Lee
G. M. Robertson
J. Kapaalahao
J. H. Smith

Honolulu, 26 Oct. 1852

He palapala hoakaka i ke ana ana i kekahi aina Kuluana. Kaili Helehu, 3033 e, waiho ana ma ke Ahupuaa o Palms, ma Hana Maui. E hoomaka ana ma kona kahi Komohana, ma Kaili, ma ka Aoao maauka. ke Alanui aupuni, Kahi i pili pu oia me ka aina. Mahoe, Kahunaaiole a e holo ana, Akau 50 1/4; Hikiina 889 Kaulahas ma ke Alanui aupuni, Hema 31 1/4. Komohana 263 Kaulahas e pili ana me ke Kumaihea, Hema 61. Hikiina 407 Kaulahas e pili ana me ke Kauhewale, Hema 40 1/4. Komohana 582 Kaulahas e pili ana me Kauhewale, Hema 72 1/4 Komohana 246 Kaulahas, e pili ana me ke Kauhewale, Hema 53; Komohana 612 Kaulahas, e pili ana me Kamai, Hema 33 1/2, Hikiina 430 Kaulahas e pili ana me Kaneniu, Akau 48 1/3, Hikiina 196 Kh. e pili ana me ke Kaneniu, Akau 50 1/4, Hikiina 720 Kaulahas e pili ana me Kaneniu, Hema 47 1/2 Hikiina 0.74 Kh. e pili ana me Kaneniu, Akau 42 1/4, Hikiina 803 Kaulahas, e pili ana me ke Mahoe, i Kahunaaiole, a hiki i Kahi i hoomaka i

Ka Ili Chiku Eka, E Kolu Ruda, a me Cha Ruda

W. P. Alexander
Mea ana aina

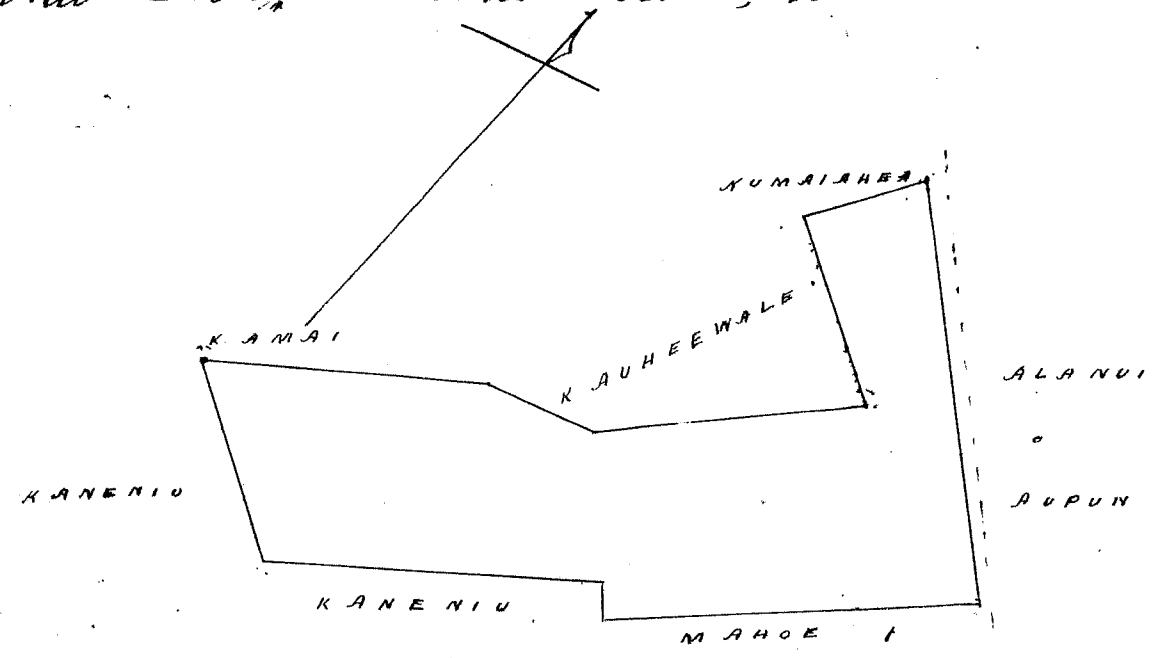

W. Pau Lee # 5
W. L. Lee
G. M. Robertson
S. Chaulakoo
J. H. Smith

Honolulu 26 Oct 1852

He palapala hoakaka i ke ana ana. ke Kahi apana aina Kuluana. Kauhewale, Helehu 4927 e, waiho ana ma ke Ahupuaa o Palms ma Hana, Maui. E hoomaka ana ma ke kahi Akau o Keia a e holo ana, Hema 61, Hikiina 407 Kaulahas e pili ana me ke Kaili, Hema 40 1/4, Komohana 582 Kaulahas e pili ana me ke Kaili, Hema 72 1/4, Komohana 246 Kaulahas, e pili ana me ke Kaili, Akau 13 Komohana 381 Kaulahas, e pili ana me ke Kamai, Hema 85 1/2, Hikiina 0.96 Kaulahas e pili ana i ke Kumaihea, Akau 32 1/2, Hikiina 446 Kaulahas e pili ana me ke Kumaihea, a hiki i Kahi i hoomaka i Ka Ili Chua Eka, a me na Ruda e hua,

W. P. Alexander
Mea ana aina

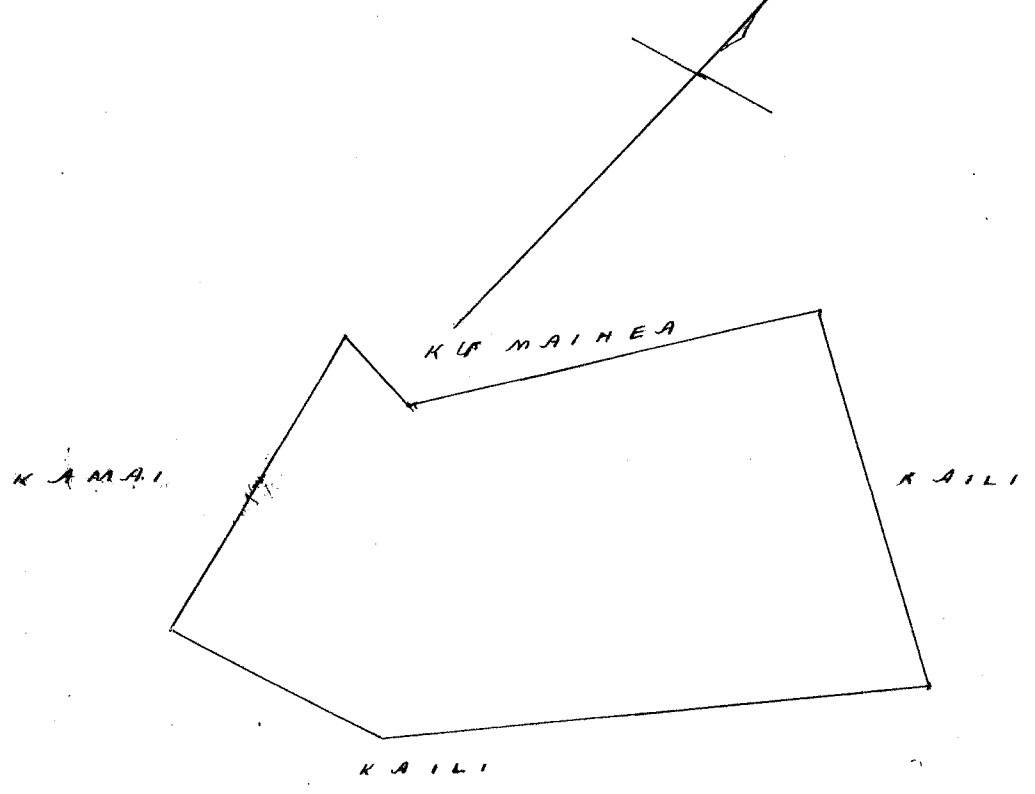

Uku Pau Loa #6

W. L. Lee
G. M. Robertson
J. Kaulahao
J. H. Smith

Honolulu 26 Oct 1852

Uku 3024 Kananuu

Wananahua, Hoana Maui

Ke palapala hookaka i ke ana ana i kekahi apana aina Kulioua. Kananuu Helu 3024 e waiho ana ma ke Ahupuaa o Wananahua o Palomo ma ke Kalana o Ana, ma ka Mokupuni o Maui. E hoomaka ana ma ke Pihikoma Hihina. Keia a e holo ana. Akau 29 1/4, Komohana o 91 Kaulahao e pili ana me Kahunaaiole Hema 52 1/2, Komohana 276 Kaulahao e pili ana me Kawainui, Hema 39 Komohana, 279 Kaulahao e pili ana me Kawainui Akau 56 Hihina 531 Hh e pili ana me Kawas, a hiki i Kahi i hoomaka i Ka Ili i Ruda, o Umikumamalu Ruda.

W. P. Alexander.

Mea ana aina

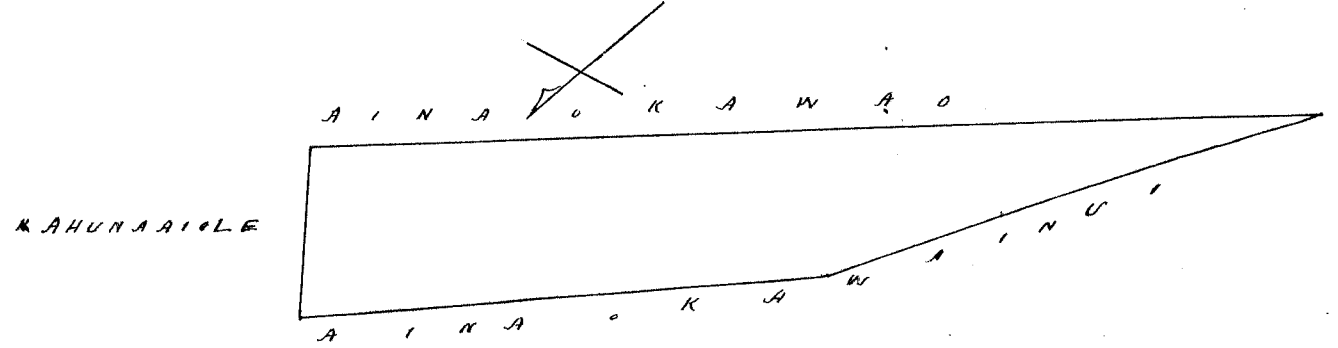

Ke palapala ma ke ana ana i kekahi apana aina Kulioua. Kananuu Helu 3024 e waiho la ma Wananahua Hoana Maui. E hoomaka ana ma ke Pihikoma Hihina o Keia. Kahi i pili ai, ia me ke Kawainui, a me ke Manu Kahunaaiole, a e holo ana, Akau 42 3/4, Komohana 271 Kaulahao, e pili ana me ke Kahunaaiole Hema 37 3/4, Komohana o 31 Kaulahao e pili ana me Kaili, Akau 47 1/4, Komohana o 74 Kaulahao e pili ana me Kaili, Hema 50 1/4, Komohana 720 Kaulahao e pili ana me Kaili, Hema 48 1/4, Komohana 196 Kaulahao e pili ana me Kaili, Akau 33 1/2, Komohana 430 Kaulahao e pili ana me Kaili Hema 406 Komohana 589 Kaulahao e pili ana me Kaulalo Hema 51 1/4, Hihina 525 Kaulahao e pili ana i ke Ahupuaa, Akau 72 3/4, Hihina 533 Kaulahao e pili ana me Kawas, Akau 41 3/4, Hihina 700 Kaulahao e pili ana i ke Kawainui, Akau 45 1/2, Hihina 203 Kaulahao e pili ana i ke Kaulalo Hihina, i Kahi i hoomaka i Ka Ili Chiku Eka a me ka Ruda hookahi.

W. P. Alexander

Mea ana aina

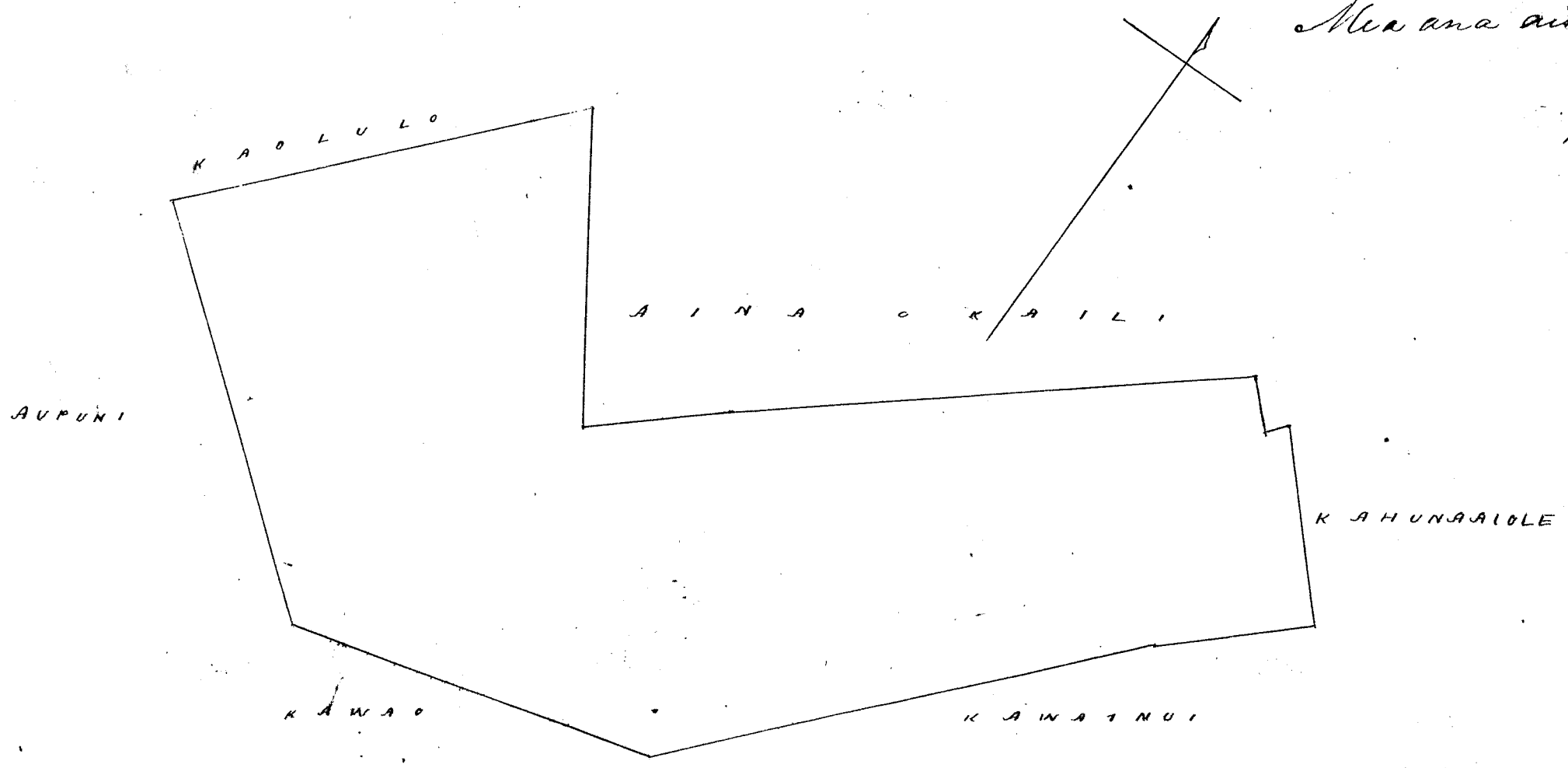

1812
781
7-92

Uku Pau Loa # 8

W. L. Lee
G. M. Robertson
J. Kaulahao
J. H. Smith

Honolulu 26 Oct 1852

Keolu 8187^B Kouhia

Kaiabolo Oahu

Apana 1. 10 Loi Kula ma Pahale. Chomaka ana ma ke kiki Maun a e holo ana
Nem. 73° Kom. 346 paunku e pili ana i ke Kahawai, Nem 47° Kom 152 Paunku e pili ana
i ke Kahawai, Nem. 57° Nihk. 500 Paunku e pili ana ma Konohiki. Ak. 51 Nihk. 150
paunku, e pili ana ma Konohiki. Ak. 7 1/2° Kom. 440 Paunku e pili ana ma Konohi-
ki, i ke kiki mua, 1,498 Eka

Apana 2. 6 Loi. Chomaka ana ma ke kiki Maun, a e holo ana, Ak. 55°
Kom. 180 paunku ma Konohiki, Ak. 41° Nihk 810 Paunku, ma Konohiki
Nem 45° Nihk. 100 paunku ma ke Konohiki, i ke Kahawai, a e holo ana
i ke Kahawai, i ke kiki mua, 8900 Eka,

Oct. 8, 1852

A. F. Turner
Luna ana aina

1,498
890
2,388

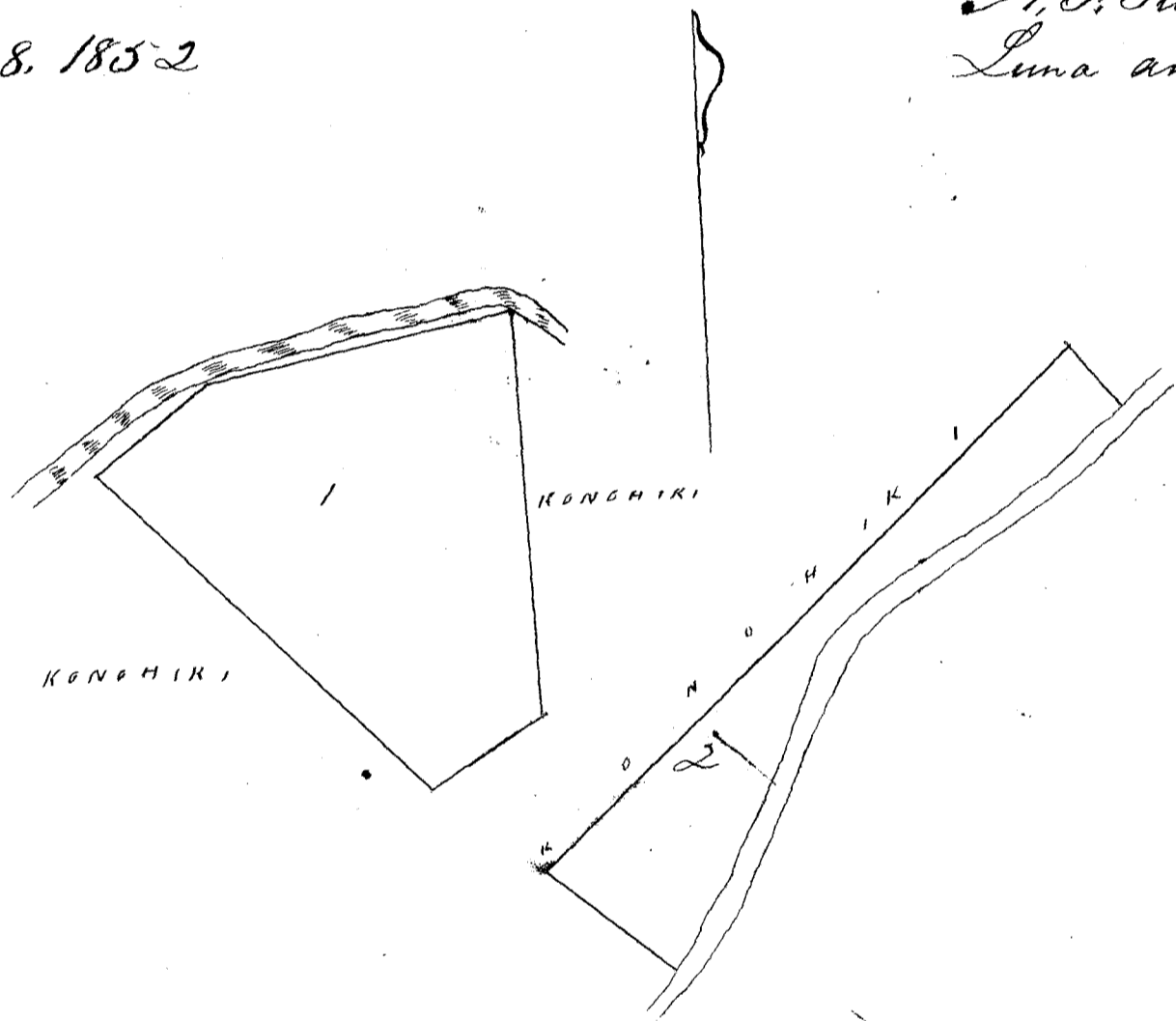

Uku Pau Loa # 6

W. L. Lee
G. M. Robertson
J. Kaulahao
J. H. Smith

Honolulu 26 Oct 1852

Keolu 5498^B Kahuku

Hamakualoa Maui

Iki o Kahauiki Ahupuaa. Uawa Chomaka ke ana ma ke kiki Kihina Maun o
Kiaa, maluna ka pali, Nem. 5 1/2° Kom 446 Kh. ma Pali, Ak 32° Kom. 544 Kh. ma Kahawai
Nem. 87° Nihk. 334 Kh. ma ka pali, a hiki ma Kahi i Chomaka i a maloko oia anapuni,
3/4 Eka.

Wailuku Sept 6 1852

John S. Bower
Mua ana aina

Kh 2 In 1

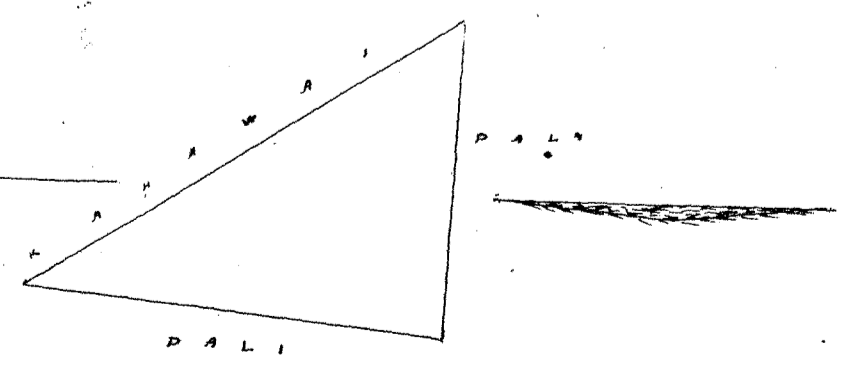

Ulu Pau Loa P 4
H. L. Lee
G. M. Robertson
C. Kukanahoa
O. H. Smith

Honolulu, 27. Oct. 1852

Kolu 4796 Kealoha

Hamakua Maui

Apaua I Ihi Waikakulu Holawa E hoomaka ke ana ma ke kiki Hikiina Kema
keia kiki Hikiina Akau. Kamohai, Akau 18 1/4 Kom. 180 Kh. ma ka Pali Kula
Ak. 15 1/2 Hiki 330 Kh. ma ka Pali Kula, Ak. 29 Kom. 412 Kh. ma ka Pali Kula
Ak. 23 1/2 Kom. 244 Kh. ma ka Pali Kakaia Kom. 24 Kom. 412 Kh. ma ka Pali
Kom. 8 1/2 Hiki 77 Kh. ma ke Manawa, Akau 59 1/2 Hikiina 371 Kh. ma ke Kamohai
a hiki ma ka hiki i hoomaka i, a maloko oia Anapuni, 2 1/10 Eka.

Mah. 1 Apaua II Ihi Puniawa Ahupuaa i Nonopu, E hoomaka ke ana ma ke
kiki Komohana Akau. Kaa, aino ma ka Kuai, Ihi Hikiina Akau, keia Kom. 86 1/4
Komohana 188 Kh. ma ka Pali ke Kai, Kom. 33 Kom. 496 Kh. ma Kahawai,
Kom. 89 Hiki. 360 Kh. ma ke Imihia Ak. 12 1/2 Hiki 450 Kh. ma ka Pali
a hiki ma ka hiki i hoomaka i, a maloko oia Anapuni, 1 3/100 Eka.

Mahule 2 E hoomaka ana ma ke kiki Akau, keia, Kom. 15 1/4 Hiki 872
Kh. ma ka Pali Kom. 13 1/4 Hiki 350 Kh. ma ka Pali, Ak. 70 Kom. 338 Kh.
ma Kahawai, Ak. 45 3/4 Hiki 66 Kh. ma ke Imihia, Ak. 35 Kom. 415 Kh.
ma ke Imihia, Ak. 14 3/4 Hiki 703 Kh. ma ke Imihia, a hiki ma ka hiki i hoo-
maka i, a maloko oia Anapuni, 2 6/100 Eka.

Apaua III Ua loa o keia
Wailuku, Aug. 13, 1852

John S. Gower
Mea ana aino

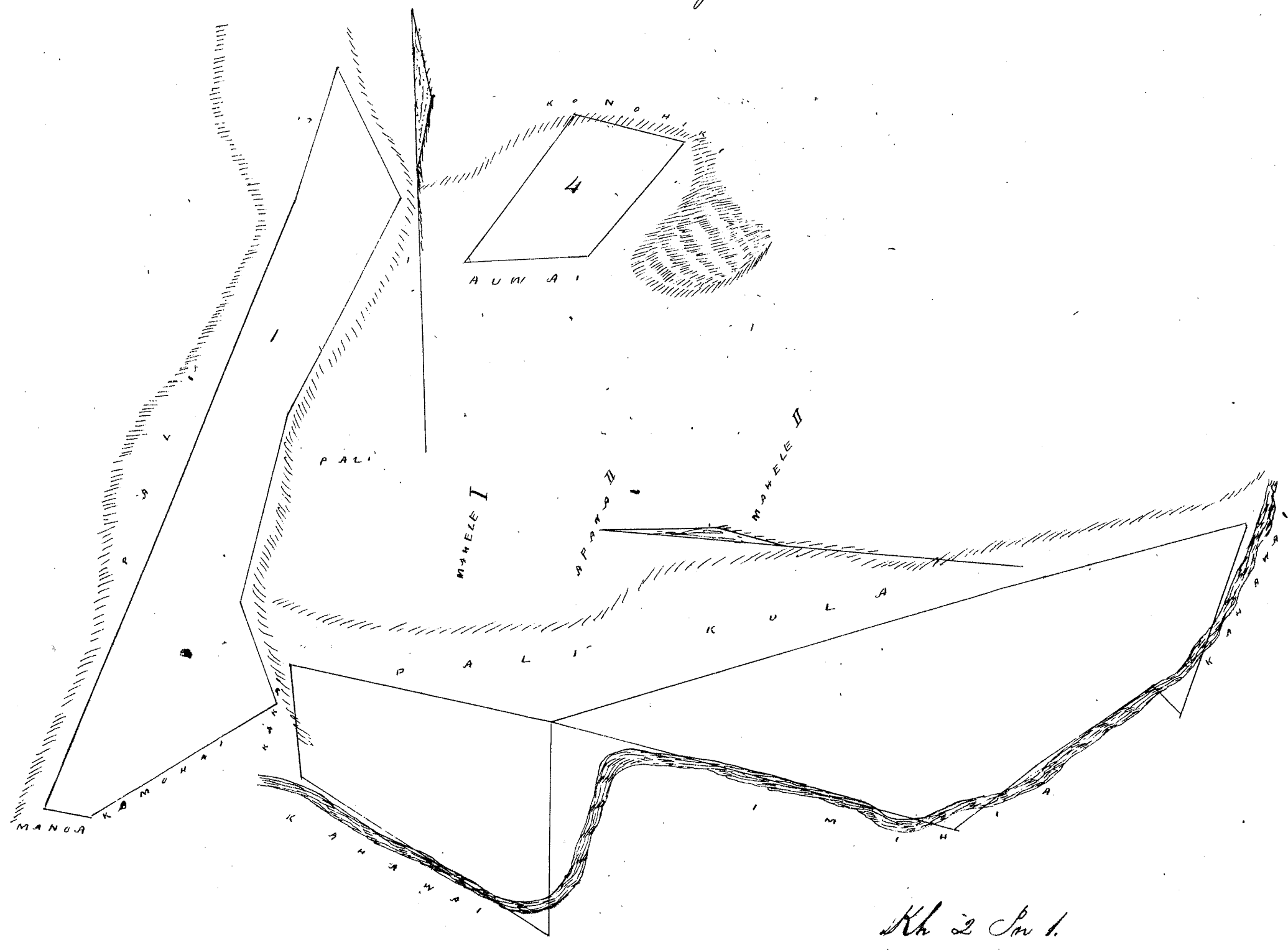

Kh 2 Pm 1.

Uku Pau Loa § 8
W. L. Lee
G. M. Robertson
O. Kaulahao
J. H. Smith

Honolulu 27 Oct. 1852

Hulu 5459 Imihia

Hamakua Maui

Apana I Ili Puniawa Honopou E hoomaka ke ana ma ke kiki Komohana Akau, o keia ke kiki Komohana Hema, Kealoha, Hem. 55° Kom. 613 Kh. ma ke Halehaku, Hem. 52° Kom. 254 Kh. ma ke Halehaku, Hema 41 Nih. 765 Kh. ma ke Pali Hem. 51 1/4 Nih. 85 Kh. ma ke Pali, Hema 12, Hihina 640 Kaulahao ma ke Pali, Ak. 12 Nih. 245 Kh. ma ke Pali, Ak. 40 1/2, Hihina 393 Kaulahao, a hiki maluna o ke Pali, Ak. 46 Kom. 252 Kh. ma ke Poalima, Ak. 38 1/4, Nih. 102 Kaulahao ma ke Poalima, Hem. 51 1/2, Nih. 70 Kh. ma ke Poalima Ak. 45 3/4, Nih. 66 Kaulahao, ma ke Kealoha, Ak. 35, Kom. 415 Kh. ma ke Kealoha, Ak. 14 3/4, Nih. 707 Kaulahao ma ke Kealoha, Ak. 89 Kom. 360 Kh. ma ke Kealoha, a hiki ma kahi i hoomaka i a ma loko oia anapuni, 9 1/4/100 Eka,

Apana II Ili Kaulakani Ahupuaa Honopou, E hoomaka ke ana ma ke kiki Akau o keia, Hem. 17 1/2, Nih. 242 Kh. ma ke Pali, Hem. 2 1/2 Kom. 376 Kh. ma ke Pali, Hem. 67° Komohana, 256 Kh. a hiki i Keia Awa, Ak. 14 1/2, Nih. 743 Kh. ma ke Kahawai, a hiki ma kahi i hoomaka i a maloko oia anapuni 67/100 Eka,

Apana III Mahale I Ili Papamuku, Honopou, E hoomaka ke ana ma ke kiki Hihina Akau o keia, e pili ana me Koopu, Hem. 18° Kom. 61 Kh. ma ke Pali, Ak. 83 1/4 Kom. 300 Kh. ma ke Nakaikuanana, Ak. 7° Nih. 110 Kh. ma ke Poalima, Hem. 74° Nih. 35 Kh. ma ke Koopu, a hiki ma kahi i hoomaka i a maloko oia anapuni,

Mahale 2 E hoomaka ke ana ma ke kiki Hihina Hema, o keia e pili ana me ke Poalima, Ak. 83 1/4 Kom. 49 Kh. ma ke Nakaikuanana, Ak. 7° Nih. 124 Kh. ma ke Kahawai, Hem. 74° Nih. 49 Kh. ma ke Koopu, Hem. 7 Kom. 115 Kh. ma ke Poalima, a hiki ma kahi i hoomaka i, a maloko oia maan Mahale 2, 34/100 Eka,

Apana III Aole loa oia,
Wailuku, Aug. 25. 1852

John S. Lower
Mea ama aima

9.44
69
34
10.47

one plan not
Copied Mapale 2

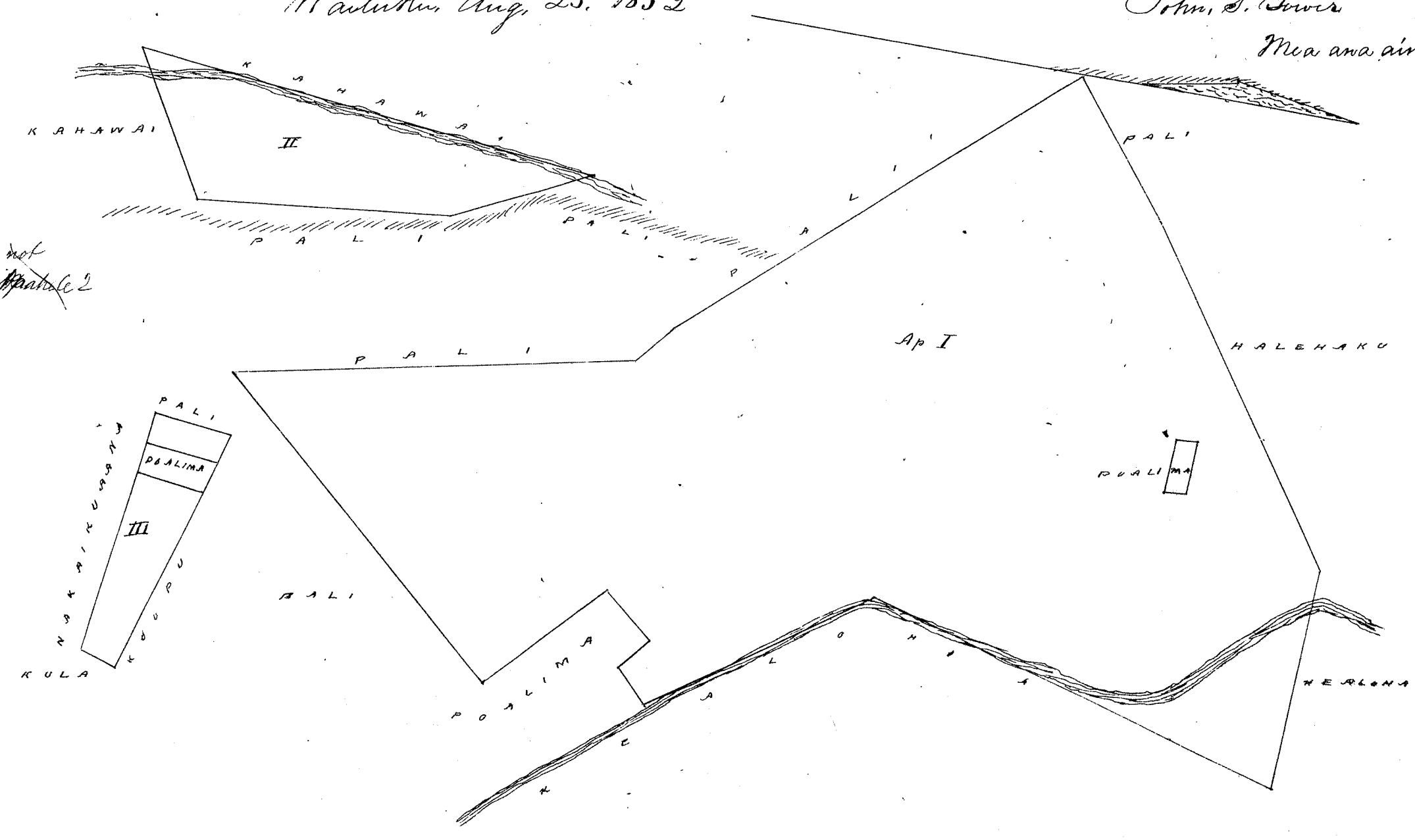

Uku Pau Loa # 10

W. L. Lee

G. W. Robertson

J. Kekaulahao

J. H. Smith

Honolulu 27 Oct 1852

Kolu 5511 Kamaha

Koamakahala Maui

Ili Kaluapooa Ahupuaa Keali; E hoomaka ke ana ma ke lili Akau - Keia,
 Aema 4 3/4; Hikina 830 Kaulahas ma Kahawai; Aema 8 1/2; Hikina 810 Kaulahas ma
 Kahawai; Aema 28; Komohana 383 Kaulahas ma Kahawai; Aema 5; Komohana 611
 Kaulahas ma Kahawai; Akau 33; Hikina 786 Kaulahas ma ka Pali; Akau 48 3/4;
 Hikina 390 Kaulahas ma ka Pali; Akau 4 1/2; Komohana 840 Kaulahas ma ka
 Pali; Akau 10 1/4; Komohana 309 Kaulahas ma ka Pali; Akau 7 3/4; Komohana 610
 Kaulahas ma ka Pali; a hiki ma ka hiki; hoomaka i a maloku oia anapuni; 9 95/100 Eka,

Wailuku Sept. 6, 1852

John S. Lewis

Ma ana aina

KAHAWAI

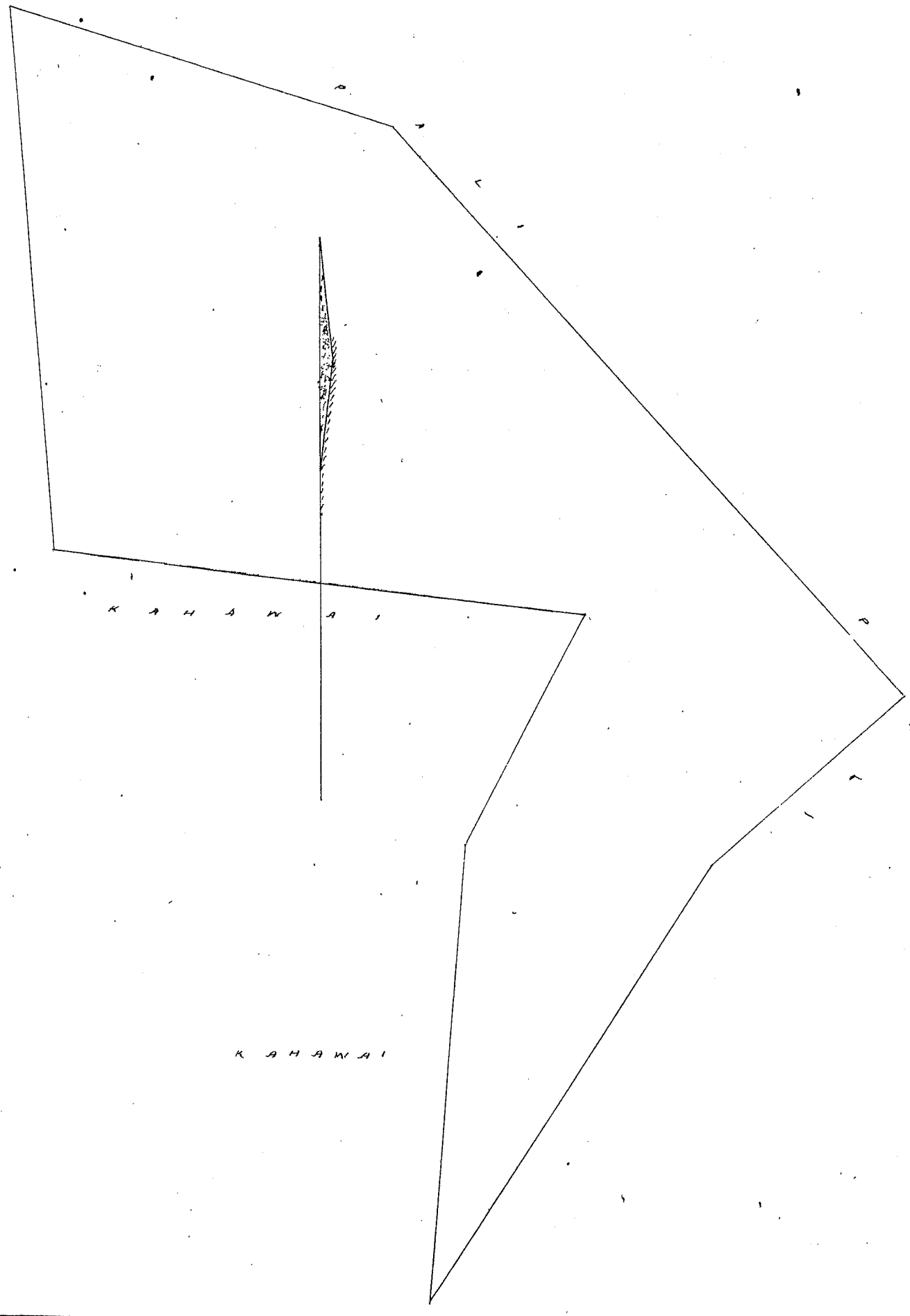

Kh 2 In 1

KAHAWAI

Uku Pau Loa # 9

W. L. Lee

G. W. Robertson

J. Kekaulahao

J. H. Smith

Honolulu 27 Oct 1852

Hele 4131 Kahoohanohano

Hamakua Maui

Mahale I Iki o Kawailoa, Kuaaha Komohana, Chomaka ke ana ma ke lili Komohana Akau o keia, Nema $77\frac{3}{4}$, Nih 357 Kaulahas, ma ka Pali; Nema $40\frac{3}{4}$, Komohana 262 Kaulahas ma ka Pali; Nema 5, Nih 12,90 Kk. ma ka Pali, Kula, Nema $69\frac{1}{2}$, Nih 315 Kk. ma ka Pali; Akau $9\frac{1}{2}$, Nih 278 Kk. ma ka Pali; Akau 30, Nihina 596 Kaulahas ma ka Pali; Akau 50, Komohana 636 Kaulahas ma ka Pali; Akau 20, Nihina 590 Kaulahas ma ka Pali; Akau $24\frac{1}{2}$, Komohana 324 Kaulahas ma ka Pali; Nema $56\frac{1}{2}$, Komohana 393 Kaulahas, ma ka Pali, a hiki ma kahi i hoomaka i a maloko ia Anapuni, 7, 23/100 Eka,

Mahale II Iki o Kawailoa, Chomaka ke ana ma ke lili Komohana Akau o keia, Nema 16, Nihina 310 Kaulahas, ma Kula, Nema 36, Komohana 498 Kaulahas ma ka Pali; Akau 63, Nihina 541 Kaulahas, ma ke Kekahuna, Akau 31, Komohana 534 Kaulahas, ma Kula me Poalima, a hiki ma kahi i hoomaka i a maloko ia Anapuni, 85/100 Eka,

John S. Gower
Ma ana aina

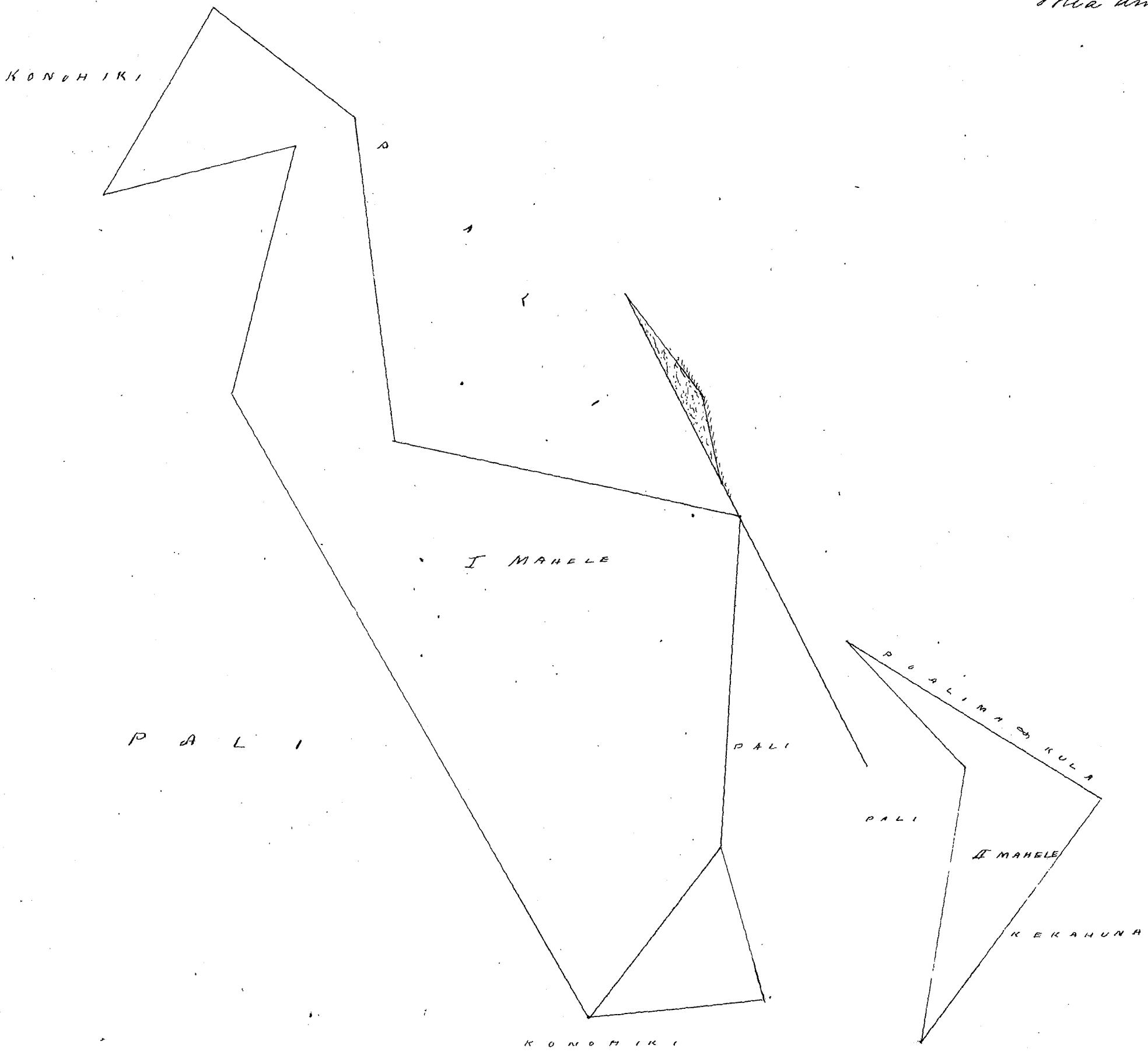

Uku Pau Loa # 9.

W. L. Lee

G. M. Robertson

J. Kekaulaha

J. H. Smith

Honolulu, 27, Oct. 1852

Apana I. Ihi Kahape Uava, E hoomaka Ke ana ma Ke Kiki Nihina Nema o Keia, Akau 12 1/4 Komohana 262 Kaulahas, ma Kula, Akau 85 1/4 Komohana 157 Kaulahas ma Kula, Akau 32 Nihina 664 Kaulahas ma Kula, Akau 26 Nihina 294 Kaulahas ma Kula, Akau 71 Komohana 317 Kaulahas, ma Kai o Keia, Nema 38 3/4 Kom. 11,00 Kaulahas ma Ka Pali, Nema 45 1/4 Nihina 332 Kaulahas, a hiki maluna, Nema 78 1/2 Nihina 476 Kaulahas, ma Kula, a hiki ma Kahi i hoomaka i, a maloko oia anapuni, 5 1/2 Eka,

Apana II Ihi o Kanui, Ahupuaa o Pauwela, E hoomaka Ke ana ma Ke Kiki Komohana, Akau o Keia, e pili ana me Ka Pali a me Pahua, Nema pouni, 455 Kaulahas ma Ka Pali, Nema 52 Nihina 211 Kaulahas, ma Ka Pali, Akau 27 Nihina 143 Kaulahas, ma Ke Holoka, Akau 22 Komohana 333 Kaulahas, ma Ka Pali, Akau 7 Nihina 143 Kaulahas ma Ka Pali, Akau 83 Komohana 104 Kaulahas ma Ke Pahua, a hiki ma Kahi i hoomaka i a maloko oia anapuni, 84 1/2 Eka,

Wailuku, Aug 13 1852

John S. Gurr
Mua ana aina

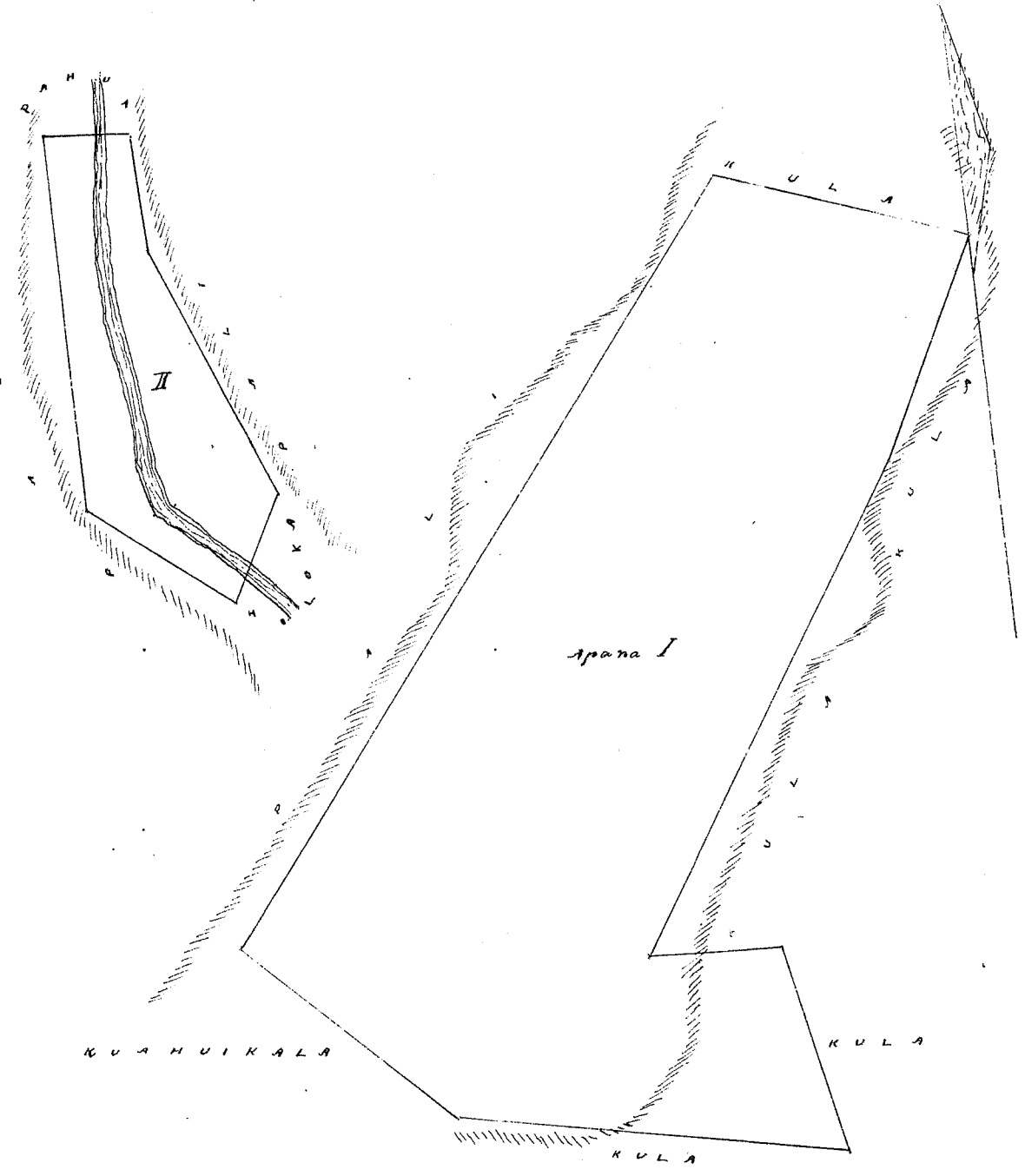

Wm Pau Loa / 7
W. L. Lee
G. M. Robertson
J. Kaulahas
J. H. Smith

Honolulu, 27 Oct 1852

Apana I Ili Kamania, Honopou. E hoomaka ke ana ma ke Pahi Nihina o Keia, e pili ana me Nakaikuana, Hema $4\frac{1}{2}$ Komohana 208 Kaulahas, ma ke Hilawe, Akau $43\frac{1}{2}$, Komohana 184 Kaulahas ma ke Hilawe, Akau 57 , Nihina 112 Kaulahas, ma ke Poalima Akau $53\frac{1}{2}$ Komohana 59 Kaulahas ma ke Poalima Akau 57 , Nihina 70 Kaulahas ma ke Mawa, Hema $53\frac{1}{2}$, Nihina 186 Kaulahas, ma ke Nakaikuana, a hiki ma Pahi i hoomaka i a malake oia anapuni, $31\frac{1}{100}$ Eka.

Apana II Ili. Uokali, o Uluku, Honopou. E hoomaka ke ana ma ke Pahi Akau o Keia, ma ka hae o Ka Pali, Hema $67\frac{3}{4}$, Nihina 100 Kaulahas, maluma pahi, Hema 79 , Nihina 31 Kaulahas, ma Kula, Hema $6\frac{1}{2}$, Nihina 100 Kaulahas, ma Kula, Hema 89 , Komohana 297 Kaulahas ma Kula, Hema $5\frac{1}{2}$, Komohana 263 Kaulahas, ma ke Kaawa, Hema $66\frac{1}{2}$, Komohana 338 Kaulahas, ma ke Kaawa, Hema 36 Komohana 234 Kaulahas, a hiki malalo, Akau 46 , Komohana 982 Kaulahas ma Kahawai, Akau $42\frac{1}{2}$, Nihina 1028 Kaulahas, ma Kahawai, Akau 37 , Nihina 437 Kaulahas ma Kula, a hiki ma Pahi i hoomaka, a malake oia anapuni, $11\frac{98}{100}$ Eka.

Apana IV & V Aole loa oia, "Wailuku, Aug 26, 1852."

John S. Gower
Ma ana aina

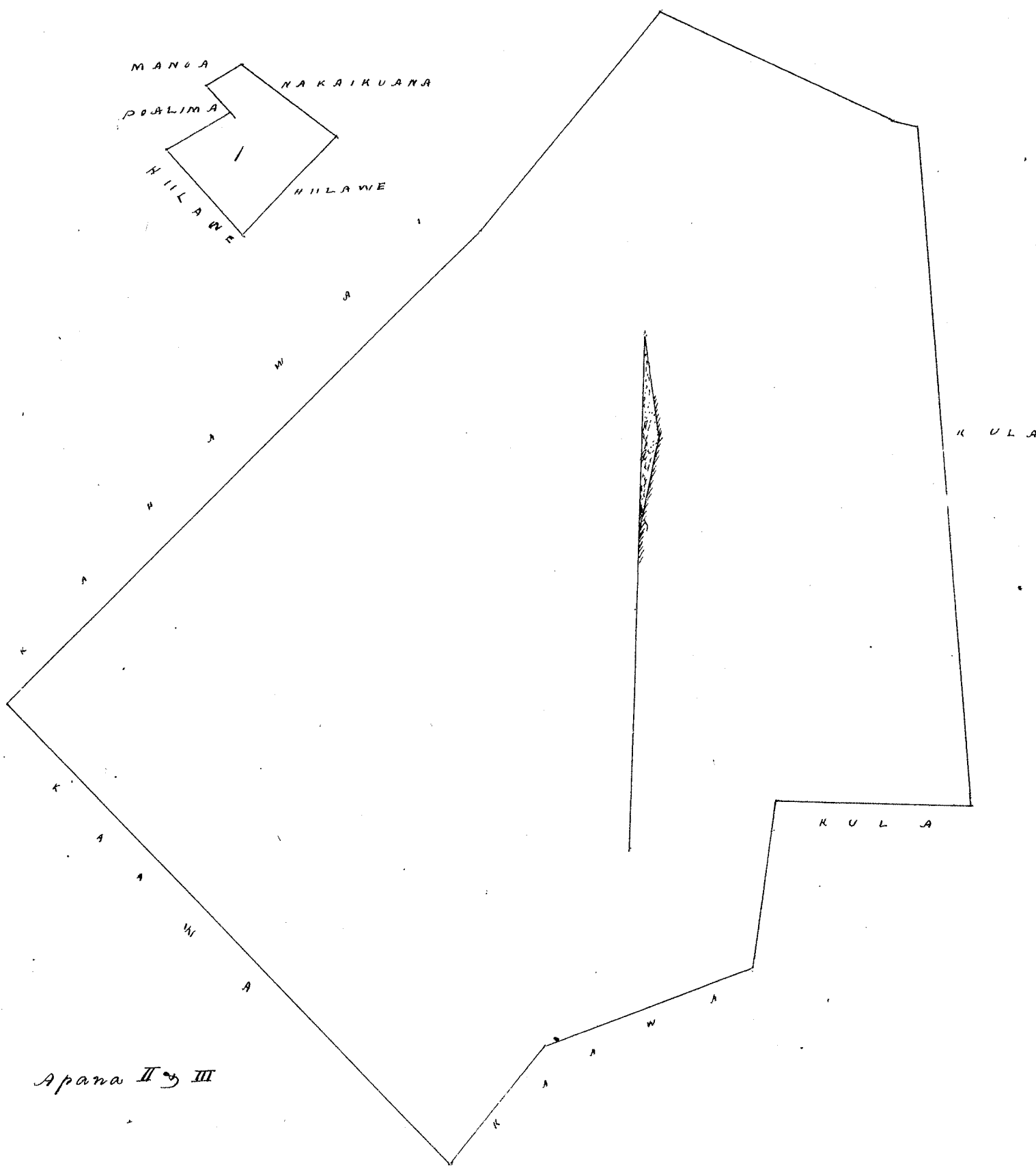

Wm. Pau Loa / 10
W. L. Lee
G. M. Robertson
J. Hekaulahao
J. H. Smith

Honolulu, 27 Oct 1852.

Helu 5250 Uheke^{B.} Hamakua Maui.

Aprana 1. Ili. Paomai, Honokala, Chomaka ke ana ma ke Pili Hibina, Akau 85 3/4, Komohana 168 Kaulahas, ma ke Konohiki, Nema 11. Hibina 119 Kaulahas ma ke Konohiki, Nema 88 3/4. Hibina 173 Kaulahas, ma Poalima, Akau 11 1/4 Komohana, ma ka Pali, a hiki ma kahi i hoomaka'i, a maloko oia anapuni 8 1/2 Eka,

Aprana 2 Ili. Keawula, Honokala, Chomaka ke ana ma ke Pili Akau e pili ana me ke Kai, Nema 61. Hibina 331 Kaulahas, ma ka Pali maluna, Nema 5 1/4 Hibina 329 Kaulahas, ma ka Pali maluna, Nema 3 1/4. Hibina 11 Kaulahas ma ka Pali maluna, Nema 6 1/2, Komohana 545 Kaulahas, ma ka Pali maluna, Komohana pona 538 Kaulahas, malalo e pili ana i ka Auwai, Akau 1 1/2, Komohana 389 Kaulahas ma ka Pali a me ka Auwai, Akau 16 1/2, Hibina 180 Kh. ma ka Pali auwai, Akau pona 52 Kaulahas, ma ka Pali auwai, Akau 40 1/4, Hibina 239 Kh. ma ke Kai, Akau 19, Hibina 304 Kaulahas ma ke Kai, a hiki ma kahi i hoomaka'i a maloko oia anapuni, 5 0 5/10 Eka,

Poalima Chomaka ma ka pahu e Kolu o Keia Kouhana, Akau 88 Komohana 565 Kaulahas, Nema pona 52 Kaulahas ma ka pali auwai, Nema 88 1/2, Hibina 567 Kaulahas, ma ka pali auwai, Akau 3 1/4, Komohana 11 Kaulahas ma ka pali maluna a hiki ma kahi i hoomaka'i, a maloko oia anapuni, 3 1/10 Eka,

Wailuku Aug 13, 1852

John S. Lewis
Mua ana aia

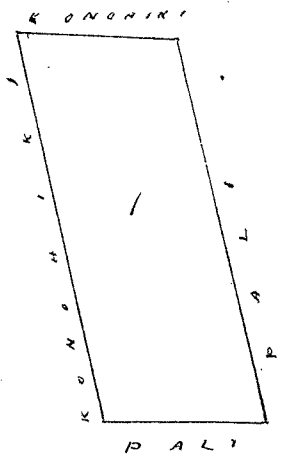
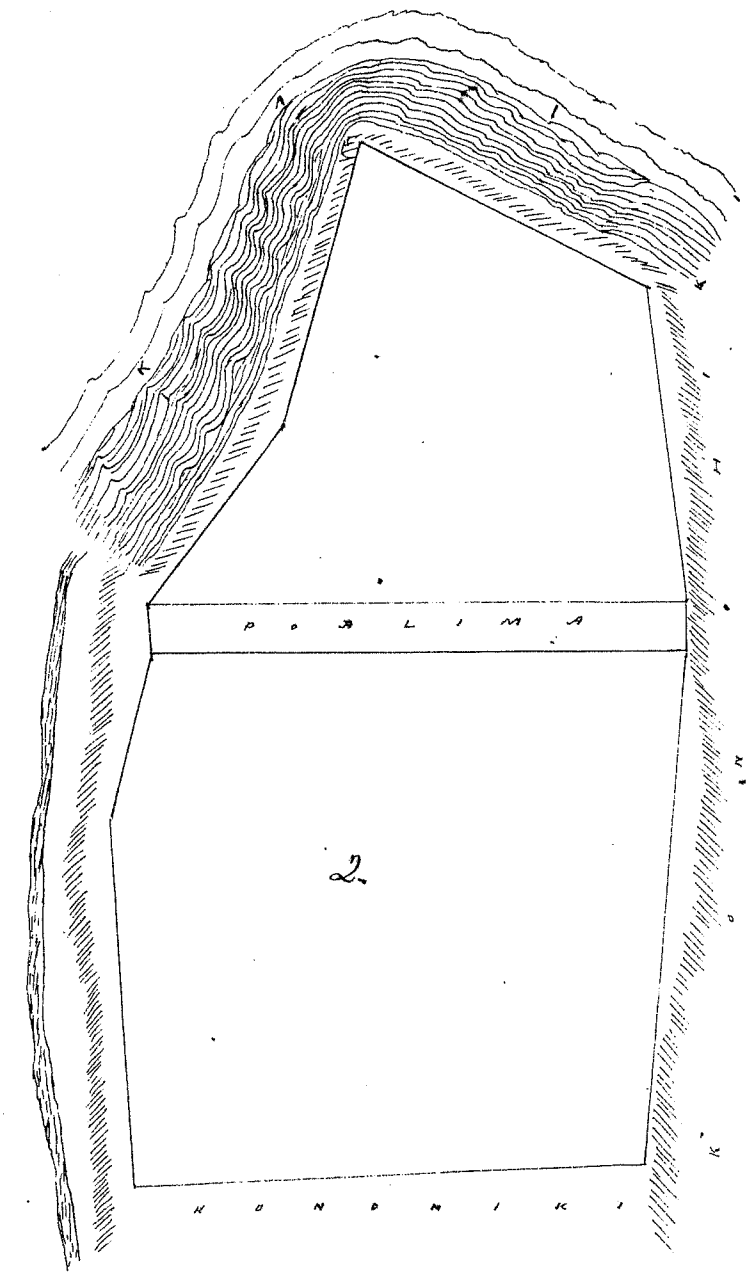

Kh. 2. In. 1

Page 5.79

Uku Pau Loa # 8
W. L. Lee
G. M. Robertson
J. Kaulahas
J. H. Smith

Honolulu, 27. Oct. 1852.

Heleu 8584 Heleu

Hamakua, Maui

Apana I. Mahi I. Ili. Kohauiki, Holawa, Chomaka ke ana ma ke Pahi Akau o Keia, Hema 40. Komohana 74 Kaulahas, ma ka Poalima, Hema 54 Hikiina 354 Kaulahas ma ka Pali; Hema 1. Komohana 356 Kaulahas, ma ka Pali; Ak. 63. Hiki 296 Kaulahas, a hiki ma kela awa, Akau 6 1/4. Komohana 360 Kaulahas ma ka Pali; Akau 74. Komohana 476 Kaulahas ma ka Pali; a hiki ma kahi i hoomaka i, a maloko ia anapuni; 1 48/100 Eka,

Mahi II Chomaka ke ana ma ke Pahi Komohana Akau o Keia, Hema 88. Hikiina 306 Kaulahas, ma ke Kohawai; Hema 32 1/2. Komohana 186 Kaulahas ma ka Pali; Akau 50 Komohana 264 Kaulahas ma ka Pali; a hiki ma kela awa, a hiki ma kahi i hoomaka i, a maloko ia anapuni 24/100 Eka,

Apana 2, Ili. Kohakono, Chomaka ke ana ma ke Pahi Akau o Hamauwaha, ke Pahi Hikiina o Keia, Hema 2 1/2. Komohana 336 Kaulahas, ma ka Auwai; Hema 69. Komohana 204 Kh. ma ka Auwai; Hema 79. Komohana 167 Kaulahas, ma ka Pali; Hema 31 1/4. Komohana 268 Kh. ma ka Poalima; Akau 69 1/2. Komohana 282 Kaulahas, ma ka Pali; Akau 11 3/4. Hikiina 334 Kaulahas ma ka Pali; Akau 86 3/4. Hikiina 435 Kaulahas ma ka Pali; Akau 41 1/4. Hikiina 330 Kaulahas, ma kela awa, a ma ka auwai; Hema 55 1/4. Hikiina 171 Kaulahas, maluna o ka pali; a hiki ma kahi i hoomaka i, a maloko ia anapuni; 2 7/10 Eka,

Apana, III, IV, & V. Ua loa ole Keia mau apana,

Wailuku, Aug. 13, 1852

John S. Gowr.
Mua ana aina,

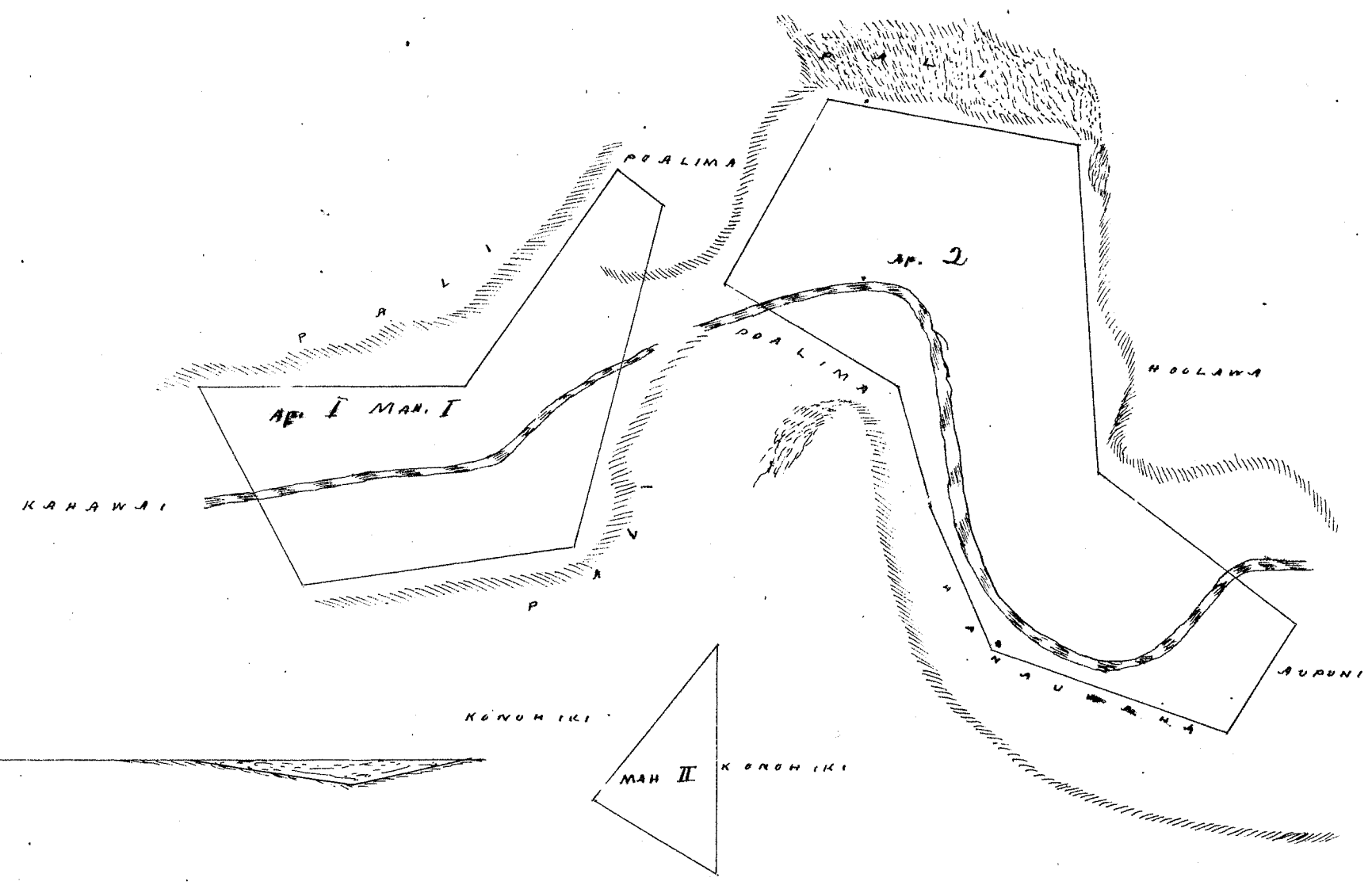

Uku Pau Loa # 7

M. L. Lee
G. M. Robertson
J. Kaulahas
J. H. Smith

Honolulu 27 Oct 1852

Apaua I. Ili Kahikiloa, Holawa, Chomaka ke ana ma ke kahi Nihina Akau o Keia, e pili ana me Moanoa, Hema 9° Kom. 569 Kaulahas ma Koula, Ak. 85 1/2° Kom. 204 Kaulahas maluna o ka Pali, Ak. 74 3/4° Kom. 154 Kaulahas ma ka Pali, Akau. 54 1/4° Komohana 374 Kaulahas ma ka Pali, Akau 66° Nihina 408 Kaulahas ma ka Pali laau, Akau 66 1/2° Nihina 345 Kaulahas malalo a hiki ma ke Moanoa, Hema 85 1/2° Nihina, 81 Kaulahas, ma ke Moanoa, a hiki ma kahi i homakai, a maloko oia anapuni 25 1/100 Eka,

Apaua 2 Ili Halepohaku, Holawa, Chomaka ke ana ma ke kahi Nihina o Keia, Akau 22° Kom. 324 Kaulahas, ma ka Auwai, Hema 75° Komohana 115 Akh, ma ke Koula, Hema. 19° Nihina 315 Kaulahas, ma Koula, Akau 77° Akh 126 Akh ma ke Kamohai, a hiki ma kahi i homakai, a maloko oia anapuni; 38/100 Eka

Apaua III Ili Kahauiki, Holawa, Chomaka ke ana ma ke kahi Komohana Akau, e pili ana me ka Pali, Hema 82 1/2° Nihina 270 Kaulahas, ma ka Pali, Hema 13 1/2° Komohana 487 Kaulahas ma ka Pali, Hema 21° Nihina 440 Kaulahas ma ka pali, Hema 63 1/2° Komohana 119 Kaulahas no ke la auao, Akau 34 3/4° Komohana 118 Akh ma ka Pali, Akau. 18 3/4° Nihina 489 Kaulahas, ma Kahawai, Akau 88 1/4° Komohana 162 Kaulahas, ma ka Pali, Akau. 63° Nihina 178 Kaulahas, ma Koula, a hiki ma kahi i homakai, a maloko oia anapuni; 1 9/100 Eka,

Apaua IIII & V Ua mahi ole ia Keia,
 Hailuku, Aug. 13, 1852.

John S. Gower
 Mea ana aima.

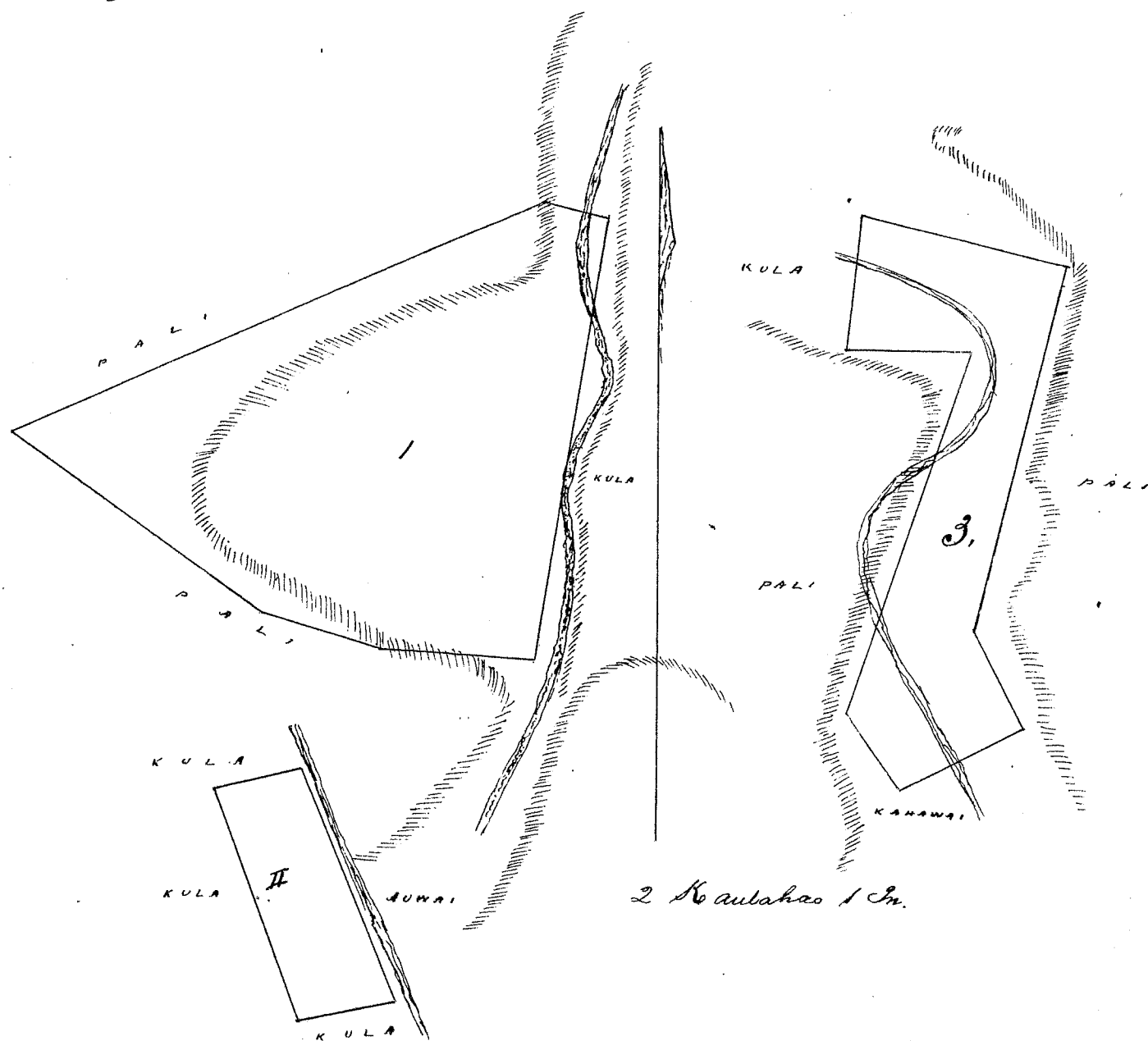

Uku Pau Loa # 7
 W. L. Lee
 G. M. Robertson
 J. Kekaulahas
 J. H. Smith

Honolulu Oct 1852

Kulu 5162 Kamohai Holawa Maui

Apana I Ili Haniapuaa, Holawa. Chormaka ke ana ma ke Pihiki Hikiina Akau... Kula, Hema 1. Hikiina 257 Kaulahao, ma Kula, Akau 79. Hikiina 126 Kaulahao, ma ka Poalima. Akau 1. Komohana 257 Kaulahao, ma Kula, a hiki ma kahi i hoomaka'i, a maloko oia Anapuni, 32/100 Eka.

Apana II Ua ai ma Kamohai, ke ana i loko, ke Kuleana, Kapahu.

Apana III Ili Kahakona, Holawa, Chormaka ke ana ma ke Pihiki Komohana Akau o keia, Hikiina pouni, 100 Kaulahao, ma Kula, Hema pouni, 253 Kaulahao ma Kula, Komohana pouni, 100 Kaulahao ma Kula, Akau pouni, 253 Kaulahao ma Kula, a hiki ma kahi i hoomaka'i, a maloko oia Anapuni, 26/100 Eka.

Apana V Ili Waikakulu, Holawa, Chormaka ke ana ma ke Pihiki Hikiina Hema o keia, E pili ana me Makua, Akau 80 3/4, Komohana 319 Kaulahao, ma ke Makua o Kula, Hema 84, Komohana 113 Kaulahao, ma Kula, Akau 3 1/4, Hikiina 53 Kaulahao ma Kula, Hema 8 3/2, Hikiina 113 Kaulahao, ma ke Manoa, Akau, 14, Hikiina 60 Kaulahao ma Manoa, Akau 57 1/2, Hikiina 371 Kaulahao, ma ke Kealoha, Hema 6, Hikiina 337 Kaulahao ma Kula, a hiki ma kahi i hoomaka'i, a maloko oia Anapuni, 3/4 Eka.

Apana VI Ua ai ke ana keia i loko, huihu ke Kuleana o Kapahu.

Apana III Ili Halulu, Chormaka ke ana ma ke Pihiki Maunaloa Hema, e pili ana me ke Naone, Akau 8 1/2, Hikiina 172 Kaulahao ma ka pali, Akau 45 3/4, Komohana 104 Kaulahao, ma ke Ala oia o ka Auwai, Hema 4 1/4, Hikiina 352 Kaulahao, ma ka Pali, Hema 68, Hikiina 263 Kaulahao, ma ka Auwai, a hiki ma kahi i hoomaka'i, a maloko oia Anapuni, 7/10 Eka.

Wailuku, Aug. 13, 1852

John S. Gower, Mua ana aia.

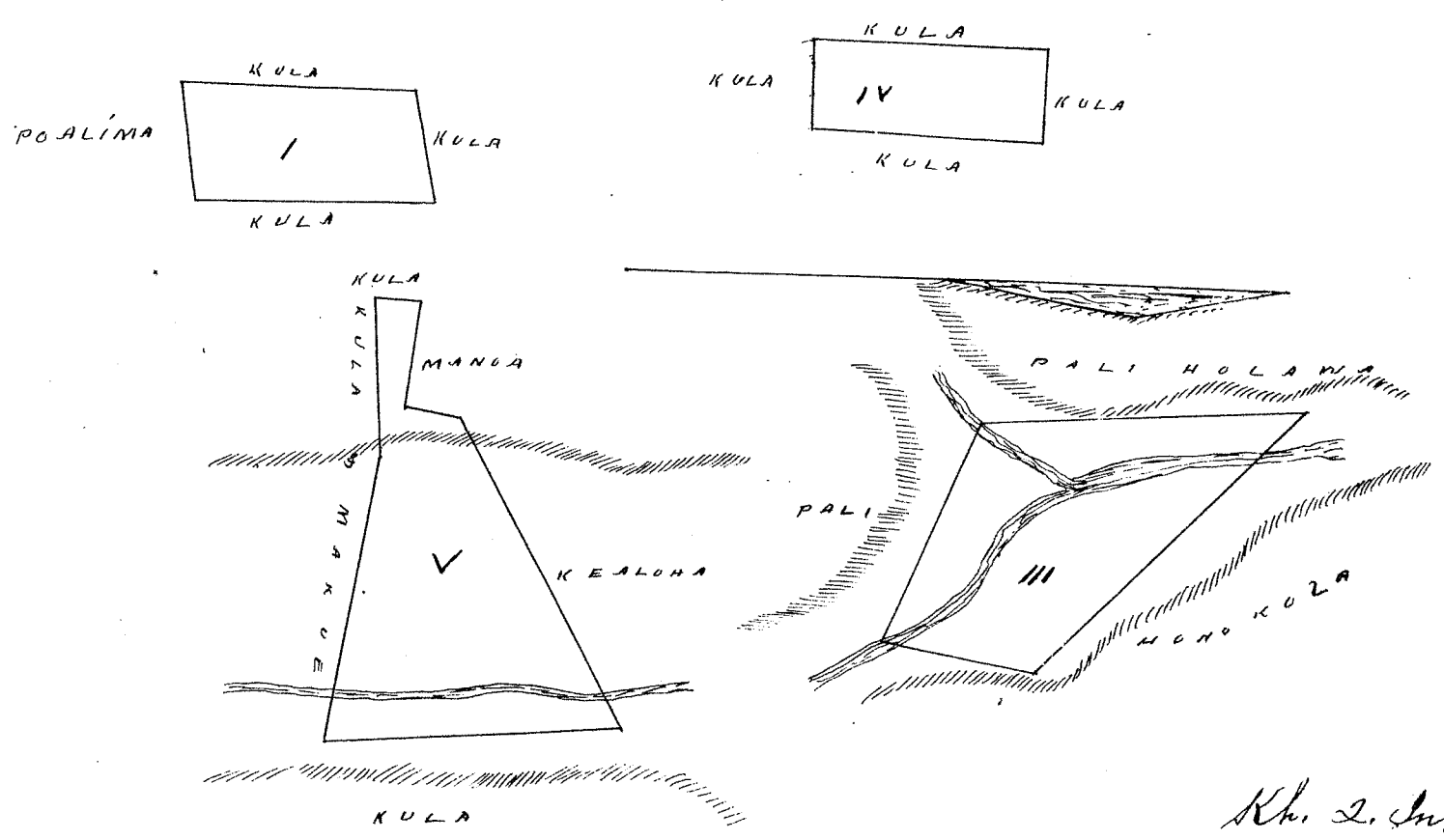

Kh. 2. In. 11

Wm Pau Low \$ 6.
M. L. Lee
G. M. Robertson
J. Kaulahao
J. H. Smith

Honolulu, 27. Oct. 1852.

Hulu 5392 Kanakakai (via Kanaokai) Hamakua Hawaii

Apana I Ua haalele via
Apana III Ua mahi ole keia
Apana V. Oona Mauka loa, aole ana,

Apana 2. Ili. Keopi-Puolua. E hoomaka ke ana ma ke Pihiki Nema. Kanaokai i loko via ili Ke Pihiki Akau o Keia, Nema 45. Komohana 423 Kaulahas ma ka Pali; Nema 7. Hihina 86 Kaulahas ma ka Pali; Akau 36 Hihina 217 Kaulahas ma ka Pali; Akau 50 3/4; Hihina 245 Kaulahas ma ka Pali; Akau 50 3/4; Komohana 65 Kaulahas; no kela aao, a hiki ma kahi i hoomaka; a maloko via anapuni; 23/100 Eka.

Apana III Ili. Ikaohia Hanohi. E hoomaka ke ana ma ke Pihiki Nema o Keia i pili ana me ka auwai; Akau 30 3/4; Komohana 809 Kaulahas ma ka Pali; Nema 32 1/2; Komohana 80 Kaulahas. no kela aao Heca, Akau 27 1/2; Komohana 456 Kaulahas ma ka auwai; Akau 32 1/2; Hihina 303 Kaulahas ma ka auwai; Nema 16; Hihina 200 Kaulahas maluna o ka pali; Nema 30; Hihina 176 Kaulahas ma ka pali maluna; Nema 37 1/2; Hihina 628 Kaulahas ma ka pali maluna; Nema 5 1/4; Hihina 176 Kaulahas maluna ma ka pali; Nema 8; Komohana 275 Kaulahas, maloko ka auwai, a hiki ma kahi i hoomaka; a maloko via anapuni; 27 1/2/100 Eka.

John S. Gove
Mea ana aina

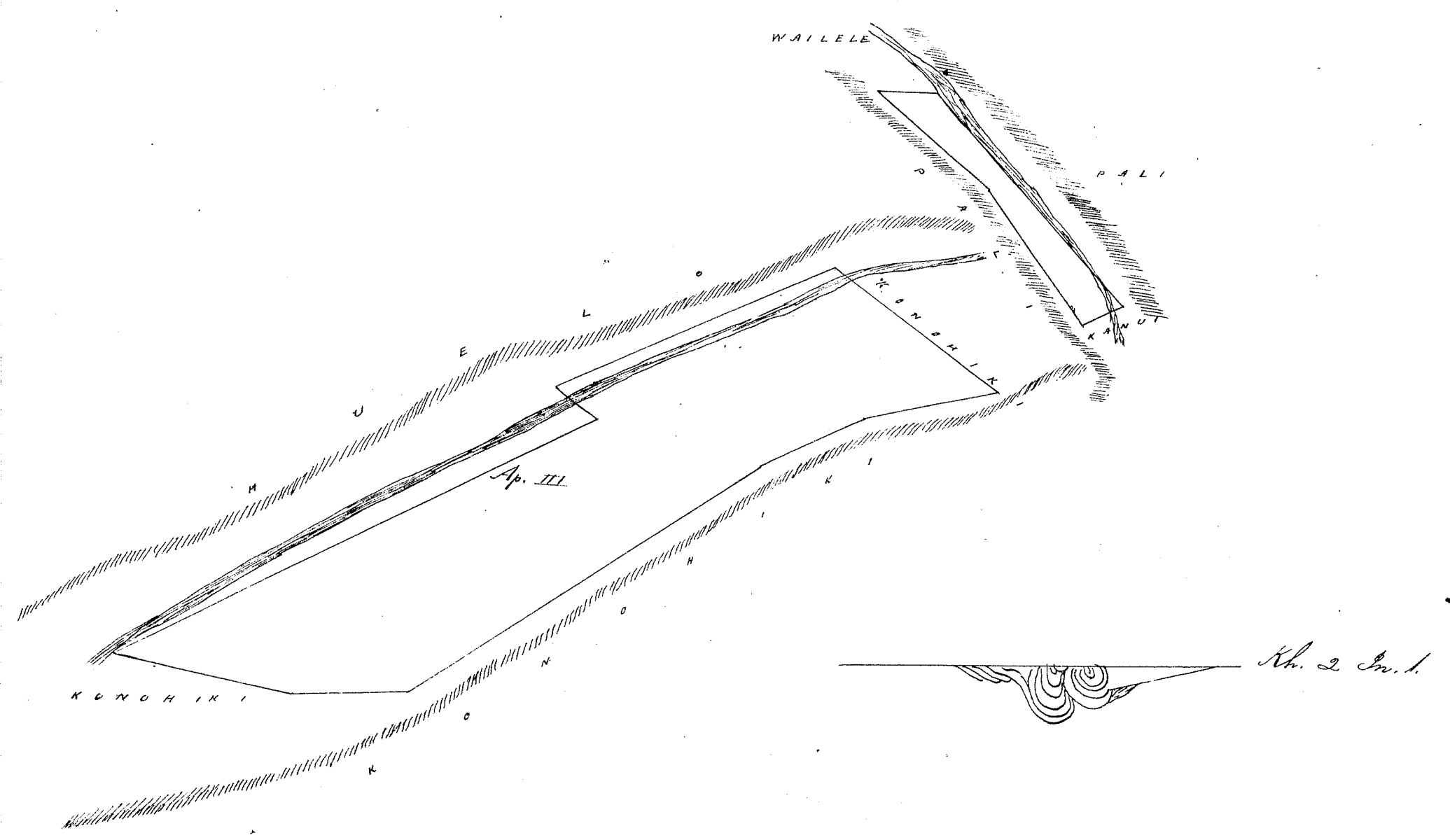

Wm Pau Loa / 6.
W. L. Lee
G. M. Robertson
J. Kaulahas
J. H. Smith

Honolulu, 27 Oct. 1852.

Hulu 5392^B Kawahine (via Makapuwahine)

Hamakua Maui

Apawa I. Ili. Pōpōpanui Puolua. E hoʻomaka ke ana ma ke Pihī ma kai, a waia ka ka
 hawaii, hiki ana e pili ana me ka pali, ma lalo, Hem. 85 1/4° Kom. 116 Kaul. ma kela aiaa, Hem. 21 1/2
 Kom. 259 Kh. ma ka Pali, Hem. 10° Kom. 71 Kaul. ma lalo o ka lae pali, Hem. 14 1/4° Kom. 322
 Kaul. ma ka pali, Hem. 82 3/4° Hiki 131 Kaul. ma ka pali a hiki i ka auwai, Hem. 13 1/4° Kom. 251
 Ke aulaha, Hem. 51 Hiki, 237 Kh. no kela auwai, Ak. 9. Hiki 145 Kh. ma lalo o ka
 pali, Hem. 7 1/2° Hiki 607 Kh. ma ka pali ma lalo, Hem. 88. Hiki 188 Kh. ma ko Kōnōhiki
 Ak. 24 1/2° Hiki 324 Kh. ma ko Kōnōhiki, Ak. 2° Ko. 186 Kh. ma Kōnōhiki, Hem. 53
 Kom. 299 Kh. ma ko Kōnōhiki Ak. 60; Kom. 174 Kh. ma lalo o ka auwai,
 A hiki ma kai i hoʻomaka i, a ma lalo oia anapuni, 4, 94/100 Eka.

Apawa II Ili. Kahawa Ahupuaa Wāipio E hoʻomaka ke ana ma ke Pihī
 Akau o keia, Hem. 7 Hiki 427. Kh. ma Kahawai, Ak. 24 1/4 Kom. 305 Kh. ma ka
 pali, Ak. 28 1/4° Hiki 166 Kh. ma ka pali, a hiki ma kai i hoʻomaka i, a ma lalo
 oia anapuni, 2/10 Eka. Wailuku Aug 13, 1852

John S. Gower,
 mea ana aina

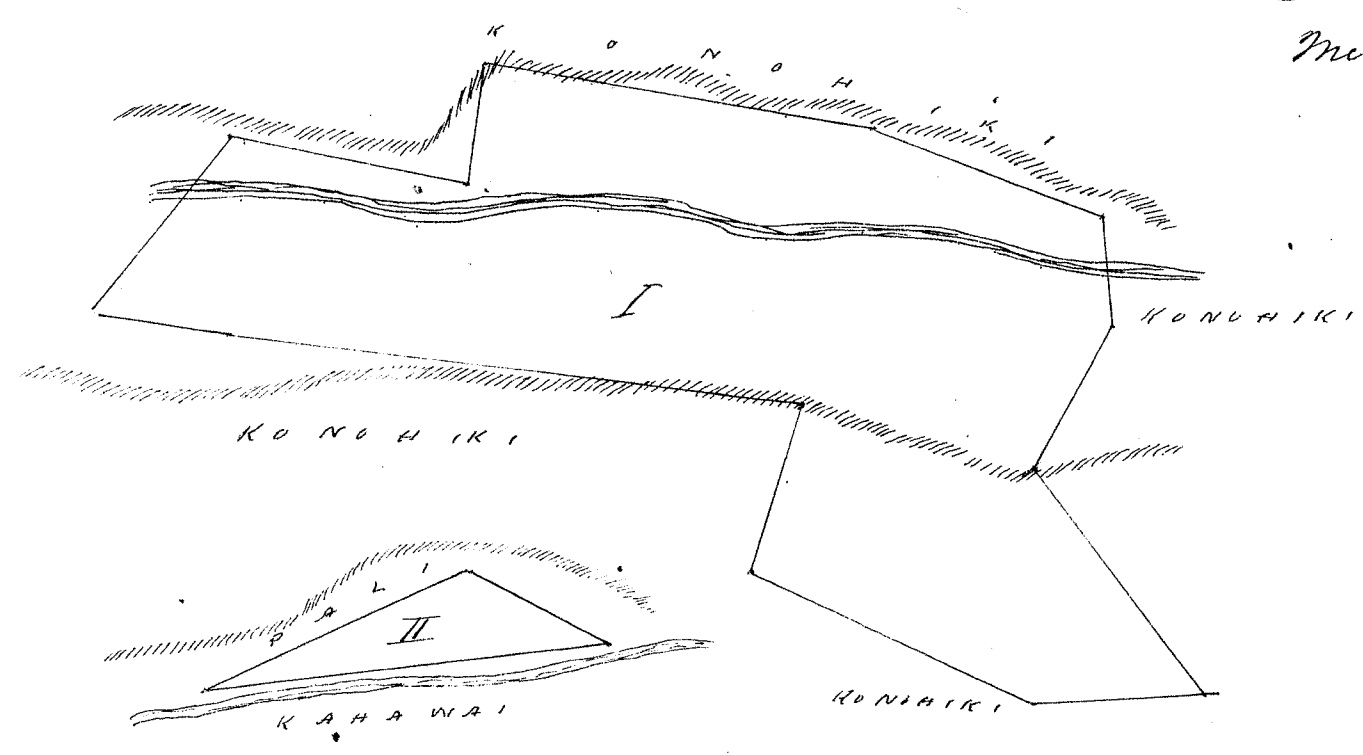

Wku Pau Loa § 7.
 W. L. Lee
 G. M. Robertson
 S. H. Smith

Honolulu 27 Oct 1852.

Hulu 5525 Kōkī.

Hamakua Maui

Ili. Ohulipōailua, Ahupuaa Wāia. E hoʻomaka ke ana ma ke Pihī hiki ana o keia, Hem. 82° Kom. 131 Kh. ma ka
 hawaii, Ak. 3 1/2° Hiki 155 Kh. ma Kahawai, Ak. 74° Hiki 190 Kh. ma Kahawai, Hem. 19° Kom. 195 Kh. ma ka
 pali a hiki ma kai i hoʻomaka i, a ma lalo oia anapuni 1/4 Eka

John S. Gower
 mea ana aina

Wailuku,
 Sept. 6, 1852

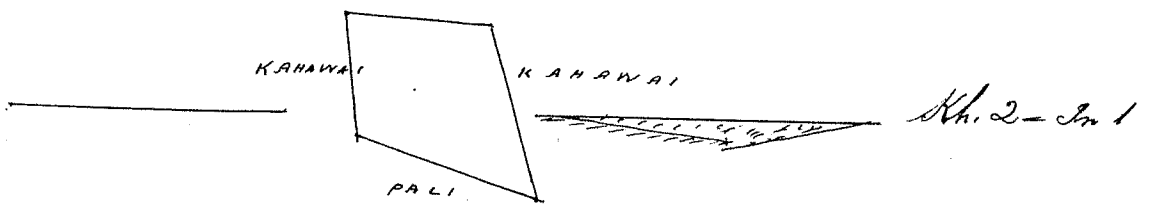

Wku Pau Loa § 4.
 W. L. Lee
 G. M. Robertson
 S. H. Smith

Honolulu 27 Oct 1852.

Helu 3704^B Uau

Hamakua Hawaii

Helu 3704^B Uau Kuleana ma Amama. Hamakua Hawaii, E hoomaka ana ma ke Pihik
Kormoh. o Keia Mauka iki o ka pa o I. a e holo ana, Hem. 84. Aik 945 Kaul. alaila Ak.
14. Hik. 16 Kaul. alaila, Ak. 82. Kom. 6 Kaul. a hiki i ke I. alaila ma ke I. Hem 31 1/2;
Kom. 1125 Kaul. a hiki i kahi e hoomaka i, Maloko o Keia, 7 3/10 Eka,

Nov. 19. 1851.

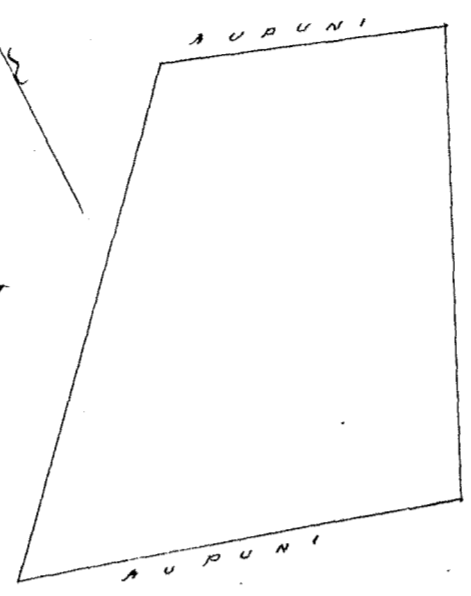

C. J. Lyons
Luna ana,

1/2 Kaulaao / Inika

Wku Pau Loa / 7
W. L. Lee
G. M. Robertson
J. Kukaulaao
J. H. Smith

Honolulu 1 Nov 1852

Helu 3700^B Keomahu

Hamakua Hawaii

Helu 3700^B Keomahu. Kuleana ma Amama. Hamakua Hawaii E hoomaka ana
ma kahi kumu o hua ai, ma ke Pihik Kema, ma Keahawai, a e holo ana, Ak. 77 1/2, Kom. 086
Kaul. o Ak. 17 1/2, Hik. 10. Kaul. a hiki i ke ala loa kahiko, alaila, Hem. 83 1/4, Hik. 683
Kaul. a hiki i kahi kumu Kukui, alaila ma Keahawai, ma ka palena o Kaohes, a
hiki i kahi e hoomaka i, maloko o Keia 7 Eka,

6.86
C. J.

Nov. 19. 1852

C. J. Lyons.
Luna ana,

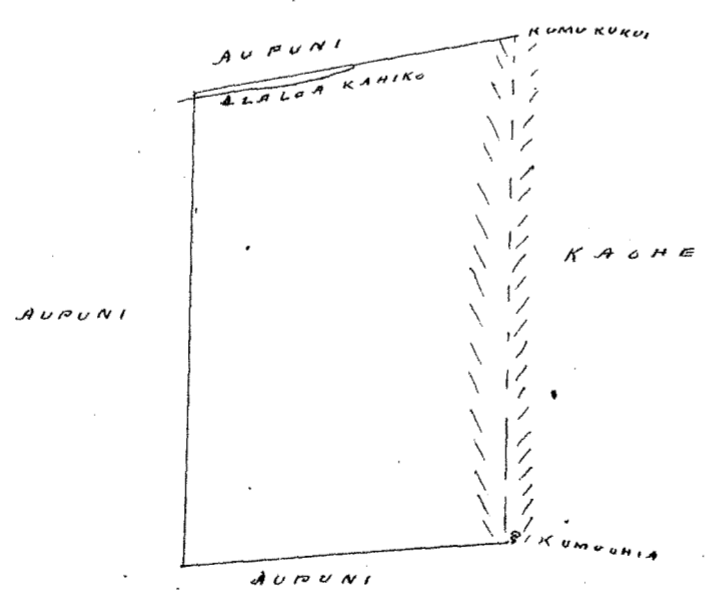

1/2 Kaul. / In.

Wku Pau Loa / 7
W. L. Lee
G. M. Robertson
J. Kukaulaao
J. H. Smith

Honolulu 1 Nov 1852.

Helu 3703^B Kauhāi Kouluana ma Ke ainihi Hamakua Hawaii E hoomaka ana ma
ke Pihī Komohana, ma Kae pali, a e holo ana. Hem. 78¹/₄° Hik 7 Kaul. a hiki: ke Kumu
Kūni, alaila holo ana i Kae, Ak. 9¹/₂° Hik 2.65 Kaul. alaila ma Ke Ke Aupuni, Ak. 85° Hem
Kaul. a hiki: Kae pali, alaila hī ana i uka ma Kae pali, a hiki: Kahi e hooma
Kae. Malaki. Heia 6¹/₂ Eka.

Nov 19, 1852.

C. J. Lyons,
Luna Ana,

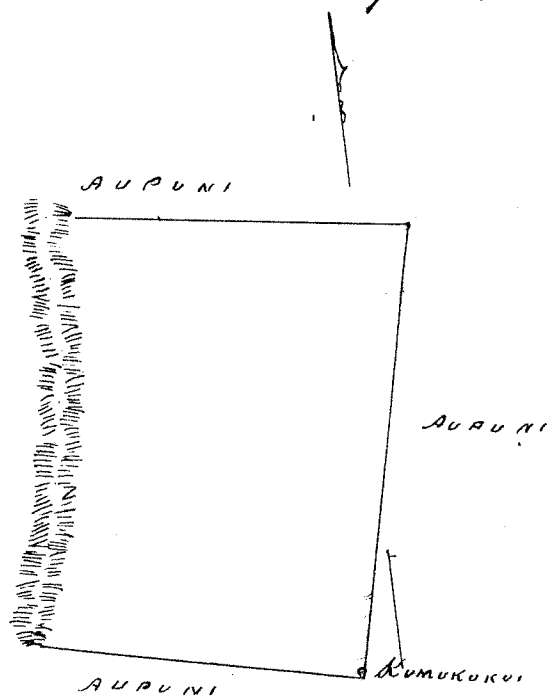

Uka Pau Ira /
W. L. Lee
G. M. Robertson
J. H. Kaulahao
J. H. Smith

Honolulu / Nov 1852.

Apana 1. Kona Pahale, ma ma Poi ai, hoomaka ma ke Pihī Kom Akau, i ke hōkūana
mi pahale, ma ke alanui, holo Hem. 72° Hem. 266 Kaula, ma ka pa aina, holo Hem. 80¹/₂°
Hik 319 Kaul. ma Ke Paie, holo Ak. 70¹/₂° Hik 1.72 Kaul. ma Kapule, holo 31¹/₂° Hik. 182
Kaul. ma Ke Kapule, holo Ak. 72° Hik 1.11 Kaul. ma Ke Kōauwahamana, holo Ak. 20° Hem. 190
Kaul. ma Kōhōhiki, holo Ak. 19¹/₂° Hem. 292 Kaul. ma Ke Kōhōhiki & hōkūana, i ke Pihī mua
Area, 1.07 Eka

Apana 2. He mau Poi ma Kawailoakai, hoomaka ma Ke Kahakai, Pihī Kom
Akau, holo Hem. 13° Hik. 148 Kaul. ma Kahakai, holo Hem. 5¹/₂° Hem. 256 Kaul. ma Ke
Luahiwa, holo Hem. 87° Hem. 0.89 Kaul. ma ka auwai Pēpi, Ak. 18° Hem. 433 Kaul. ma Ke
hōkūana, Ak. 58° Hik 130 Kaul. ma Ke Kapule, Ak. 75° Hik 127 Kaul. ma Ke Kōau-
wahamana, hema 45¹/₂° Hik 0.55 Kaul. ma Ke Kōauwahamana, Hem. 54¹/₂° Hem 0.60
Kaul. ma Ke Kapule apana 2, Hem 31° Hik 2.00 Kaul. ma Ke Kapule apana 2. I ke
Pihī mua, Area 1.14 Eka.

Waialua, Oct 12, 1852.

J. S. Emerson,
ma ana,

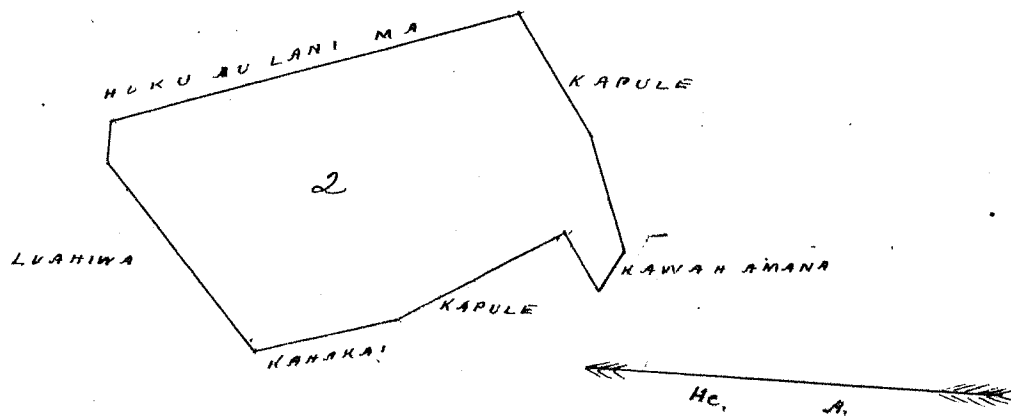
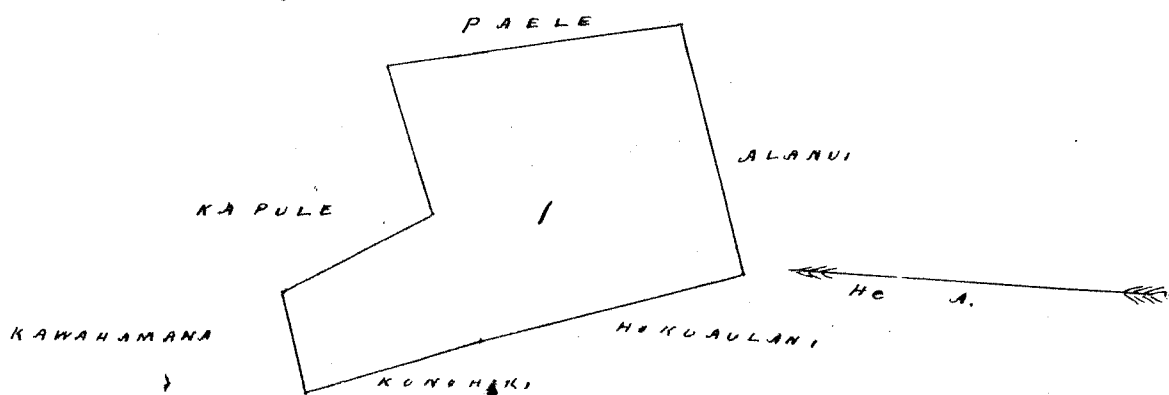

Uku Pau Loa # 6
W. L. Lee
G. M. Robertson
J. Kekaulahao
C. H. Smith

Honolulu 2 Nov 1852

Heleu 3702 ^{B.} Nawai Hamakua Hawaii

Kuliana ma Ika Hamakua Hawaii. E hoomaka ana ma ke Kihikihia, a pili ana me
ka pali, a e holo ana, Ak. 77 1/2, Kom. 4, 45 Kaul. a hiki i ka palena o Manowaikeha,
alaila ma ia palena Ak. 10, hiki 12 Kaul. alaila ma ke ke Aupuni, Kom. 8 1/2, hiki 9, 10
Kaul. a hiki i ka lili pali; alaila holo ana i uka, ma ka lili pali a hiki i kahi i hoo-
maka i Maloke i Keia, 9 1/10 eka,

Nov 20, 1852

C. J. Lyons.
Luna ana

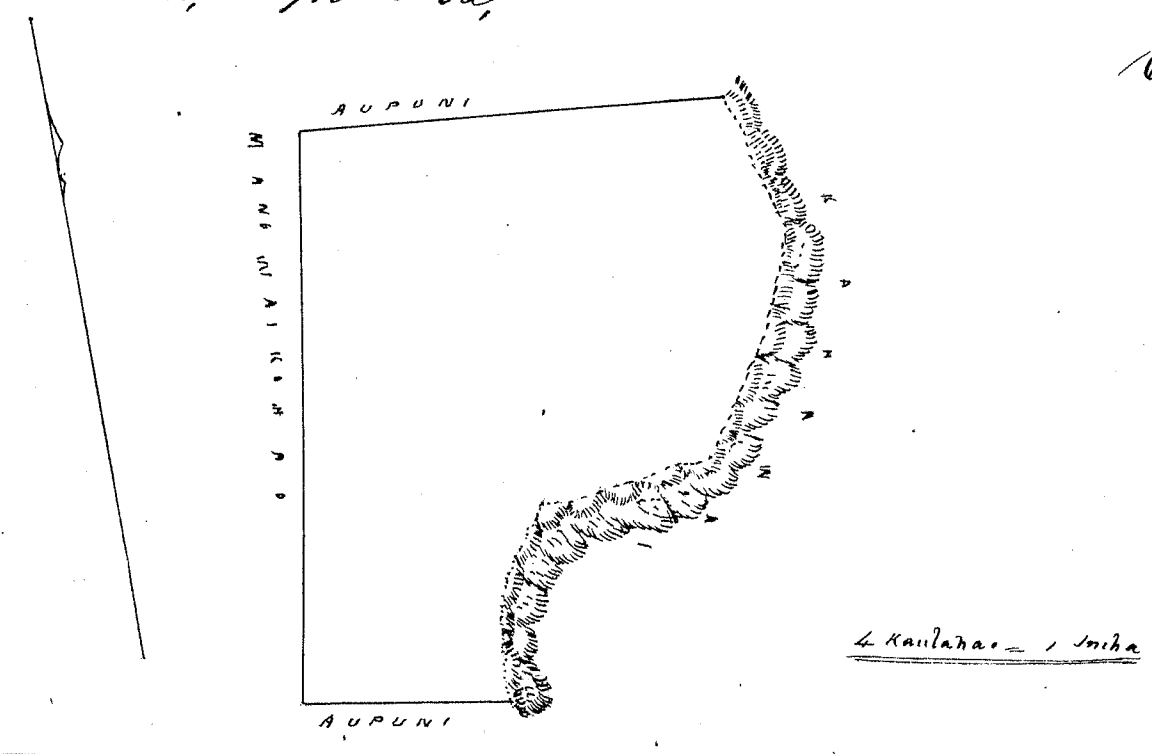

Uku Pau Loa # 8
W. L. Lee
G. M. Robertson
J. Kekaulahao
C. H. Smith

Honolulu 1 Nov 1852

Heleu 3701 ^{B.} Paakana Hamakua Hawaii

Kuliana ma Alacabita Hamakua Hawaii. E hoomaka ma ke Kumu Kuku, a ku
ana ma Kahawai, ma ke Kihikihia o Keia, ma kai o ke ala loa, a e holo ana, Ak. 68 Kom.
11, 60 Kaul. a hiki i ke Kahawai o Kaunooali, alaila iho ma ia Kahawai, 5, 55 Kaul. a hiki
i ke Papapa, alaila ma ke Papapa, Kom. 79, hiki 4 Kaul. a hiki i kahi Kumu ulu, alaila
Kom. 71, hiki 65, 2 Kaul. moku ana ke awawa kope, a hiki i ka palena o Kemau, ma
Kahawai, alaila pii ma ke awawa Kuku, a hiki i kahi i hoomaka i Maloke o Keia
6 5/10 eka.

Nov 15, 1852

C. J. Lyons. Sur.

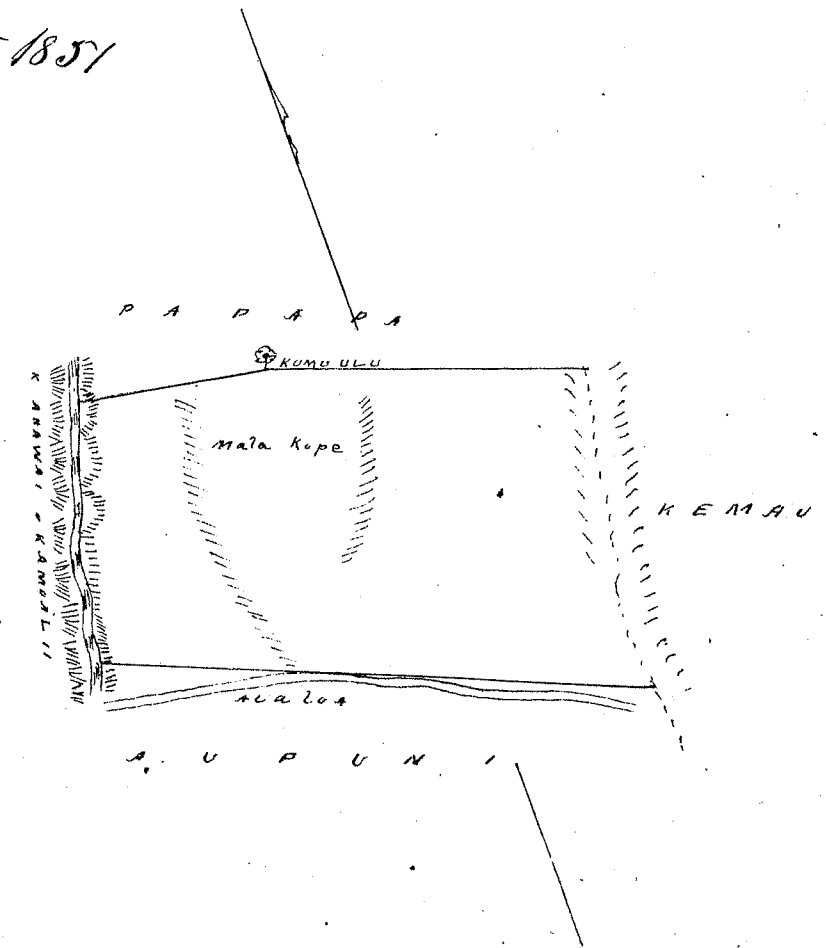

Uku Pan Loa # 7
W. L. Lee
G. M. Robertson
S. Kukaulakao
J. H. Smith

Honolulu 1 Nov 1852.

Heleu 10285. Makanana

Hamakua Hawaii

Koukua ma Keatakaha 2, Hamakua Hawaii, E hoomaka ana ma ka paku e Ku ana ma ke alanui, ma ke Pihia Hema, ma ke Komohana a. Kahi awawa, a e holo ana ma ke alanui Aupuni; Ak. 69 1/2, Kom. 736 Kaul. moku ana ke awawa, alaila holo aku i kai; Ak. 21, Hik. 8 Kaul. alaila ma ke ke Aupuni; Hem. 73 1/2, Hik. 7,60 Kaul. a hiki i ke Pumu ohia, ma ke Pihia Hikiina, alaila Hem. 22, Kom. 8,45 Kaul. ma kele Keatakaha, a hiki i Kahi hoomaka i Matalo, Keia, 6 15/100 eka.
Nov 20, 1851.

C. J. Lyons
Luna ana.

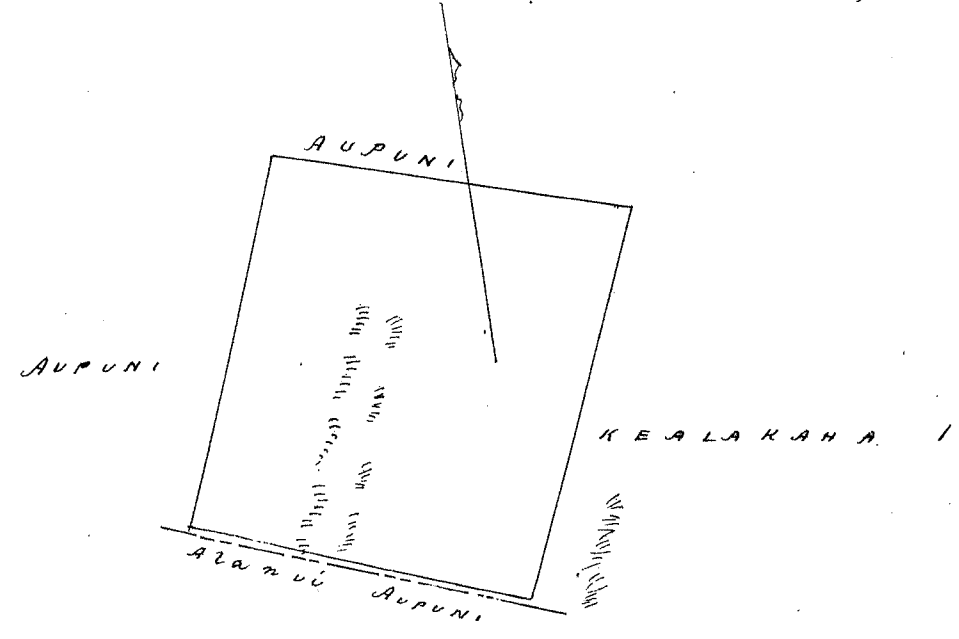

4 Kaulakao = 1 Incha

Uku Pan Loa # 7
W. L. Lee
G. M. Robertson
S. Kukaulakao
J. H. Smith

Honolulu 1 Nov 1852.

Heleu 3705 ^B Koolau

Hamakua Hawaii

Koukua ma Koolau, Hamakua Hawaii E hoomaka ana ma ka paku ma kai pali, ma ke Pihia Hema, a e holo ana, Ak. 75, Kom. 730 Kaul. alaila holo ana i kai, ma kaiaoo Komohana, ka auwai hiki Ak. 10, Hik 942 Kaul. alaila moku ana ma awawa nei, a holo ana, Hem. 78 1/4, Hik 710 Kaul. a hiki i kai pali, alaila ma ka hiki pali a hiki i Kahi hoomaka i Matalo, Keia } Eka.
Nov 19 1851

C. J. Lyons
Luna ana

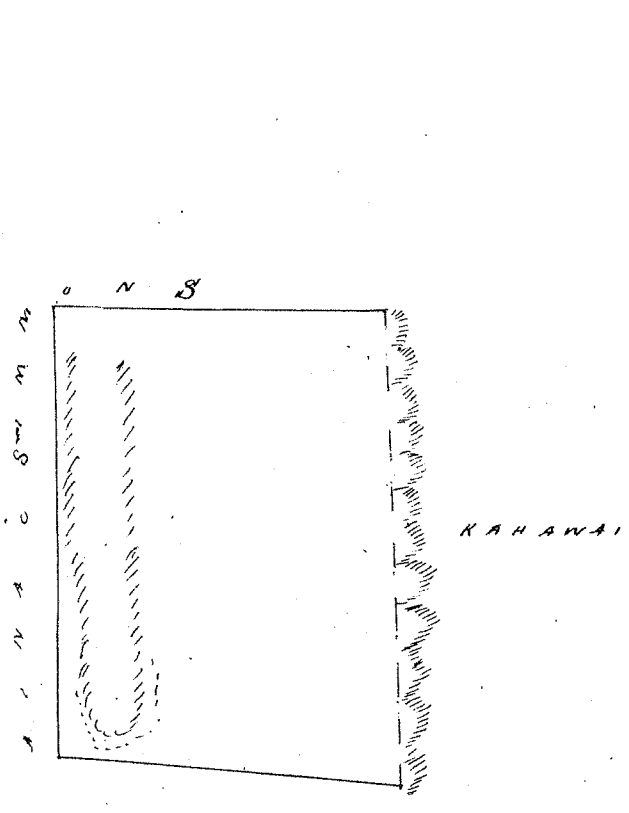

4 Kaulakao = 1 Incha

Uku Pau Loa 7
W. L. Lee
G. M. Robertson
J. Kekaulaha
J. H. Smith

Honolulu 1 Nov 1852

Kolu 5836 Kohawaiolaa

Kailua Koolau Oahu

Moo aina i loko o Waimaanuu Kailua Oahu.
E hoomaka ma ke Pihikina e hulu ana, Kum. 70. Hik. 3.30 Kh. ma Kohawai
Malaila aku, Ak. 61. Kom. 3.30 Kh. Malaila aku, Ak. 28. Hik. 268. Kh. ma
ka palena no Koha, Malaila aku, Kum. 51. Hik. 3.00 Kh. ma ka palena
no Kaea, Malaila aku, Ak. 45. Hik. 100 Kh. Malaila aku, Kum. 46.
Hik. 240 Kh. ma ko Kaea, a hiki i ka hoomaka ana
ke Eka 1. me 7¹/₁₀₀ Kh. huinaha.

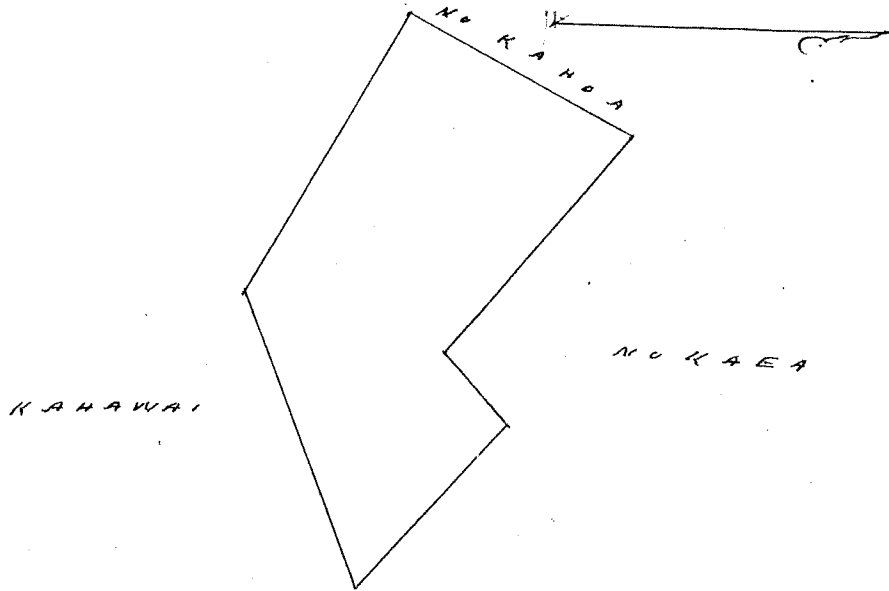

A Bishop
ma ana.

Uku Pau Loa 5
W. L. Lee
G. M. Robertson
J. Kekaulaha
J. H. Smith

Honolulu 2 Nov 1852

Kolu 3190 Kealina

Kailua Oahu

Mai 655 Vol. 6.
Apana 4 Elua Ii i loko o Kaula Kailua Oahu. E hoomaka ma ke Pihikina
e hulu ana, Akau 26. Komohana i 240 Kh. ma ka palena no Kealina Malaila aku,
Akau 62. Pihikina i 20 Kh. ma ka palena no "na la elua" Malaila aku, Akau 31.
Komohana 230 Kh. ma ko Komohiki Malaila aku, Akau 58 Pihikina i 0.90 Kh.
Malaila aku, Akau 36. Pihikina i 412 Kh. ma ko Komohiki, Malaila aku, Kum. 62.
Komohana 282 Kh. a hiki i ka hoomaka ana, 7²/₁₀₀ Kh. huinaha.

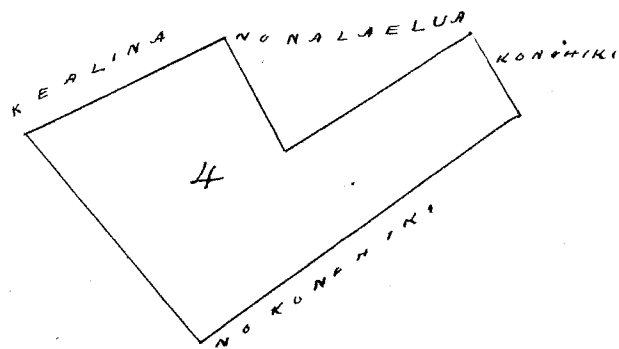

A Bishop.

from Page 655 v. 6.

Uku Pau Lou \$1.00

W. L. Lee
G. M. Robertson
J. Kekaulahao
J. H. Smith

Honolulu 3 Nov 1852

Kulu 3156 Meheua I

Kailua, Oahu

Apana 1. He moos aina i Panahau, Kailua Oahu. E hoomaka ma ke Pihik Akau, e hule
awa, Hem. 55; Kom. i 0,90 Kh. ma ka palena no Hwahewanui, Malaila aku, Hem. 32; Hik. i
0,90 Kh. ma ka palena Koele, Malaila aku, Hem. 52; Kom. i 2,00 Kh. Malaila aku, Akau
44, Kom. i 212 Kh. ma ka palena Koele, Malaila aku, Hem. 36; Kom. i 260 Kh. ma kula
no Konoehiki, Malaila aku, Hem. 40; Hik. i 1,20 Kh. Malaila aku, Hem. 45; Kom. i 556 Kh
ma ka palena kula o Konoehiki, Malaila aku, Hem. 38; Hik. i 140 Kh. Malaila aku, Akau
55 Kom. 3,50 Kh. a hiki i ka
hoomaka ana, 3 Eka 1. ³⁴/₁₀₀ Kh. huinaha Pau loa, 4 Eka 2 ⁵⁶/₁₀₀ Kh. huinaha

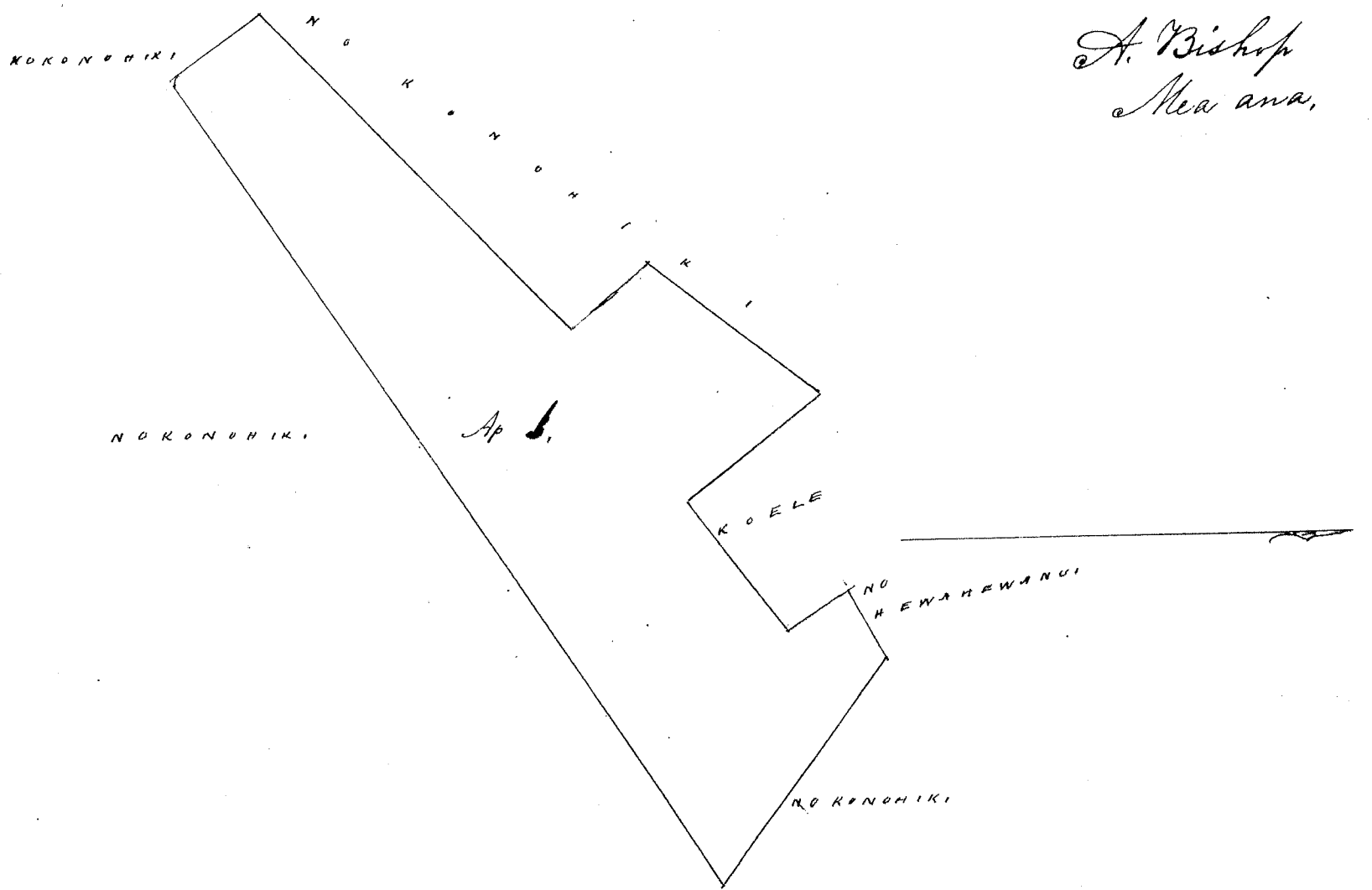

A. Bishop
Mea ana,

Ap ana 2. He Kahuahala maloto o Kaula, E hoomaka ma ke Pihik Hikina e hule
awa, Komohana 120 Kh. ma Kula o Konoehiki, Malaila aku, Ak. 20; Komohana: 3,00
Kh. Malaila aku, Hikina i 200 Kh. ma Kapahala o Kaula, Malaila aku, Hema
20; Hikina i 300 Kh. a hiki i ka hoomaka ana He 3 ³⁰/₁₀₀ Kh. huinaha

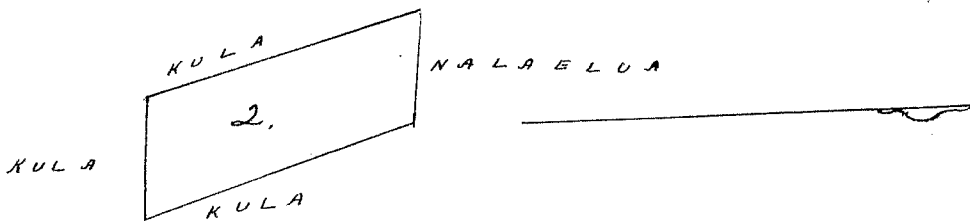

A Bishop

4, 2, 36
3, 30
6, 4, 5, 66

Uku Pau Lou \$ 7

W. L. Lee
G. M. Robertson
J. Kekaulahao
J. H. Smith

Honolulu 3 Nov 1852

^c
Nellu 3905. Koolia (Golia)

Kamahualea Maui.

Apana I Ihi Luwai - Pauwela - E hoomaka ke ana ma ke Pihī Komohana Akau, o keia, e pili ana me Ke aonohimaka, 1 Hema 6 1/2; Komohana 445 Kaulahao ma ka pali.
2. Hema 23; Hikiina 145 Kaulahao, ma Pali; 3. Hema 22 Komohana, 43 Kaulahao, ma ka pali
4. Hema 79; Hikiina 145 Kaulahao ma ke Pali; 5 Akau 6 1/2; Komohana 225 Kaulahao ma Pali;
6 Akau 4 1/2; Komohana 432, Kaulahao ma Pali; 7 Hema 16 1/2; Komohana, 67 Kaulahao ma Ke aonohimaka, a hiki ma kahi i hoomaka; 77/100 Eka,

Apana II Ihi Luwai, E hoomaka ke ana ma ke Pihī Hikiina Akau o keia e pili ana me Opunui, Akau 85; Kom. 346 Kh. ma Ke Opunui, Hema 6 1/2; Hiki 3,65, Kh. malalo. Kahawai, Hema 85; Hiki, 346 Kh. ma Ke onohiki, Akau, 6 1/2, Komohana 365 Kaulahao ma ke Konohiki, a hiki ma kahi i hoomaka; a maloko oia anapuni, 1 1/4 Eka,

Apana III Ihi Paukei; - Keuioha Komohana, E hoomaka ke ana ma ke Pihī Akau o keia, ma ka pali malalo, Akau 8 1/2; Hiki, 396 Kaulahao ma ka Pali; Hema 52; Hiki 263, Kaulahao, ma ka pali; Hema 20 1/2; Komohana 319 Kaulahao ma ka pali; Hema 36 3/4; Komohana 533 Kaulahao ma ka pali; Akau 5 2 1/4; Kom 474 a hiki malalo, Akau 17 1/2; Hikiina 691 Kaulahao ma Ke Oanahu, a hiki ma kahi i hoomaka; a maloko oia Anapuni, 4 6 1/4 Eka

Apana IIII Aole loa,
Wailuku Sept 10, 1852

John S. Gower
Mea ana aina

77
1.25
4.64
6.66

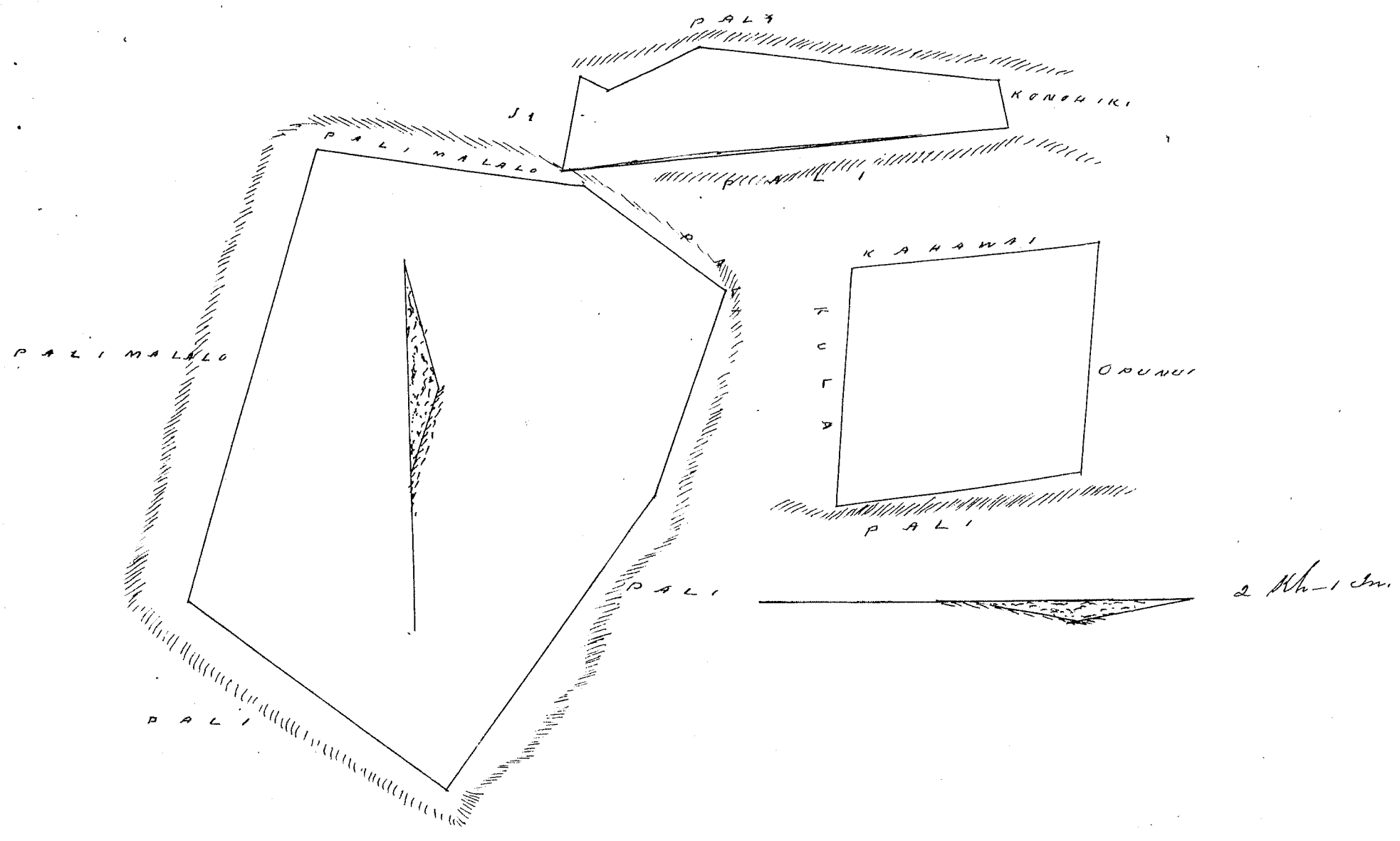

Uku Pau Loa # 8
W. L. Lee
G. M. Robertson
J. Kaulahao
J. H. Smith

Honolulu, 27 Oct 1852

Apana 1. Ihi Palau - Hulu. E hoomaka ke ana ma ke kiki Akau o Mahe, Ihi o Ohia, aao Hikiina o Keia, Hema 20 1/4; Komohana 247 Kaulahas, ma ka pali; Akau 8 1/4; Komohana 148 Kaulahas ma ka pali; Akau 56; Hikiina 180 Kaulahas, ma ka Auwai; Akau 13 3/4; Hikiina 612 Kaulahas, ma ka pali; Akau 31 Hikiina 293 Kaulahas ma ka pali; Akau 24; Komohana 313. Kaulahas, ma ka pali; Akau 84 3/4; Hikiina 290 Kaulahas, ma ka Pali, Hema 5 3/4; Hikiina 347 Kaulahas, ma ka pali; Hema 17 1/4; Komohana 447 Kaulahas, ma ka pali maluna. Hema 33 3/4; Komohana. 205 Kaulahas, ma ka pali maluna. Hema 36; Komohana 155 Kk. a hiki ma kahi i hoomaka i a maloko oia anapuni, 259/100 Eka.

Apana 2. Ihi o Ohia - Puolua. E hoomaka ke ana ma ke kiki Akau o Keia, Hema 24 1/2 Hikiina 172 Kaulahas, ma kela aao o ka auwai; Akau 82 1/2; Komohana 322 Kaulahas ma ka pali; Akau 71; Hikiina 224 Kaulahas no kela aao o ka auwai; Akau 16; Hikiina 54 Kaulahas a hiki ma kahi i hoomaka i a maloko oia anapuni, 21/100 Eka.

Apana II Olana mauka loa.

Apana III Ua mahi ole ia keia apana.

Wailuku, Aug. 11, 1852

John S. Lower
Mea ana aina

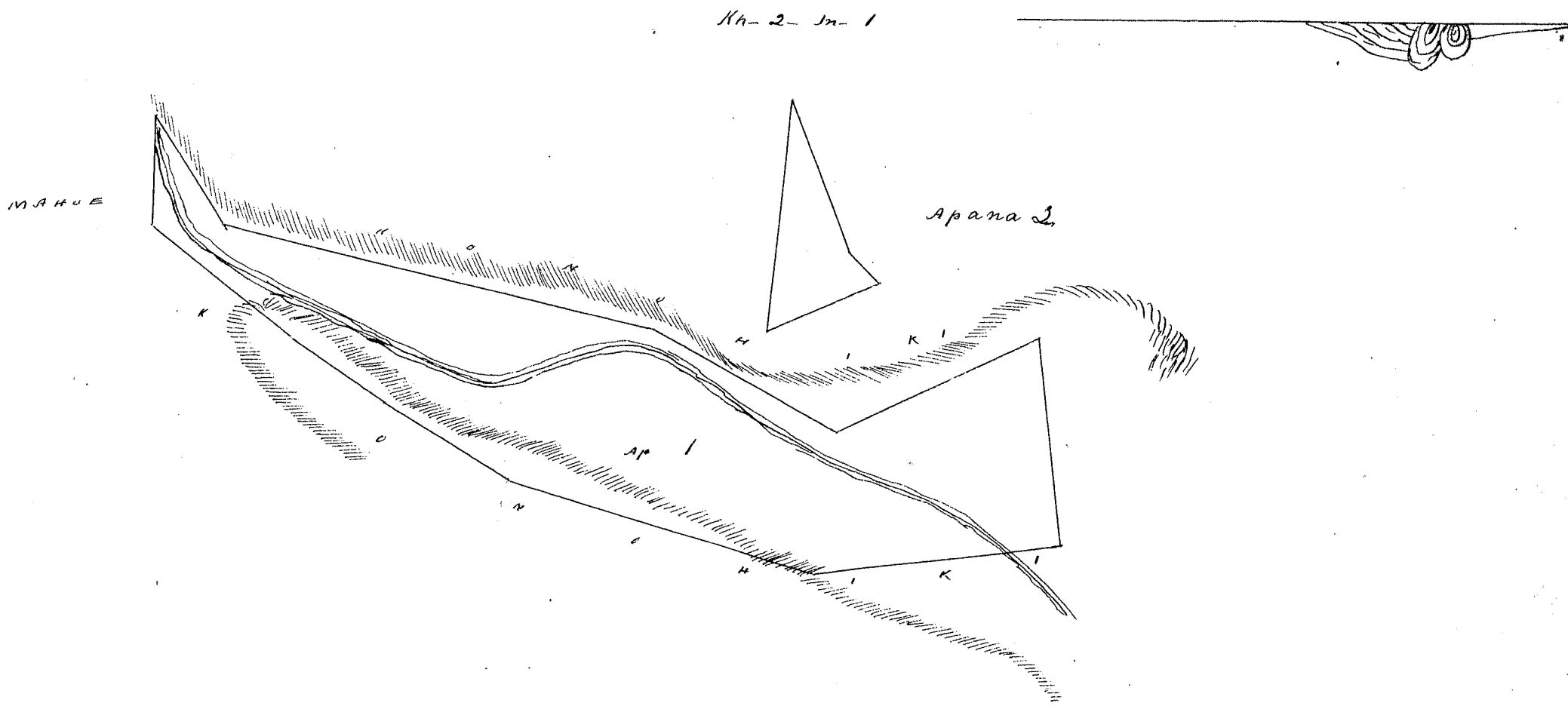

Uku Pau Loa p 6.
W. L. Lee
G. M. Robertson
J. Kaulahas
J. H. Smith

Honolulu, 27 Oct. 1852.

Hulu 5393 Komaiikai

Hamakualoa Maui.

Mahele I Iki Pohakuele-Halehaku. E hoomaka ke ana ma ke kahi Aema o Keia Akau 37 1/2; Hikiina 1.69 Kaulahas, ma Kula. Akau 26 1/2; Hikiina 400 Kaulahas ma Kula. Akau 60; Komohana 10.00 Kaulahas, ma Kula. Aema 47 Komohana 571 Kaulahas, ma Kula. Aema 57 1/2; Hikiina 11.65 Kaulahas ma ke Kohawai; a hiki ma kahi i hoomaka i, a maloko ia anapuni. 6 1/100 Eka.

Mahele II E hoomaka ke ana ma ke kahi Hikiina, Keia. Aema 74 1/2; Komohana 613 Kaulahas, ma ka pali. Akau, 52; Komohana 306 Kaulahas ma ka pali. Akau 74 1/2; Hikiina 613 Kaulahas a hiki i hula aua Aema 52. Hikiina 306 Kaulahas ma Kohawai; a hiki ma kahi i hoomaka i, a maloko ia anapuni 1 1/2 Eka.

John S. Howar.
Mea ana aina

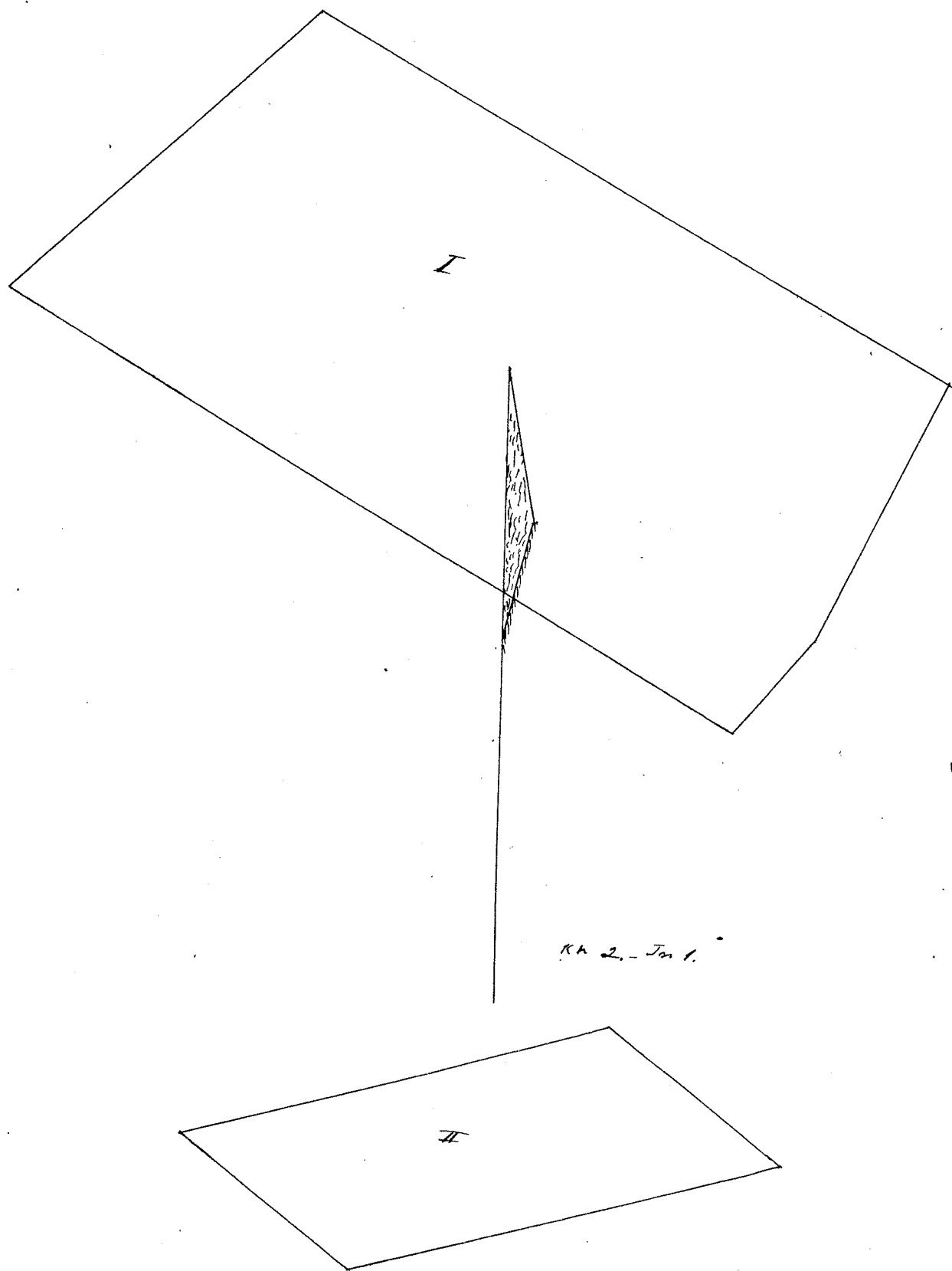

Uku Pai Loa # 8
W. L. Lee
S. M. Robertson
J. Kekaulahas
J. H. Smith

Honolulu, 27 Oct. 1852.

Hulu 5016 Kuapuu

Hamakua, Maui

3181

Apana 1. Ili Pohakaiole, Kiriha Komohana. E hoomaka ke ana ma ke kahi Hihina Akau, Keia, a pili ana me ka pali, Nema 25° Hihina 670 Kaulahao, ma ka pali, Nema 87° Komohana 217 Kaulahao, a hiki i kela aoao, Akau 33 1/2° Komohana 638 Kaulahao ma ka pali, Nema 69° Komohana 215 Kaulahao ma ka pali, Nema 24 1/2° Komohana 296 Kaulahao ma ka pali, Akau 3° Hihina 287 Kaulahao ma Kahawai, Akau 75 1/2° Hihina 360 Kaulahao ma Kahawai, Akau 68 1/2° Hihina 91 Kaulahao a hiki i kela aoao, Akau 82 1/2° Hihina 150 Kaulahao maluna o ka pali, a hiki ma kahi i hoomaka i a maloko oia anapuni 1.91/100 Eka.

Apana 2. Iloko o ka Kaai, Ua ae no Kuapuu

Apana 3 Ua mahi ole ia keia apana.

Wailuku, Aug. 25, 1852.

John S. Lewis

Ma ana aina

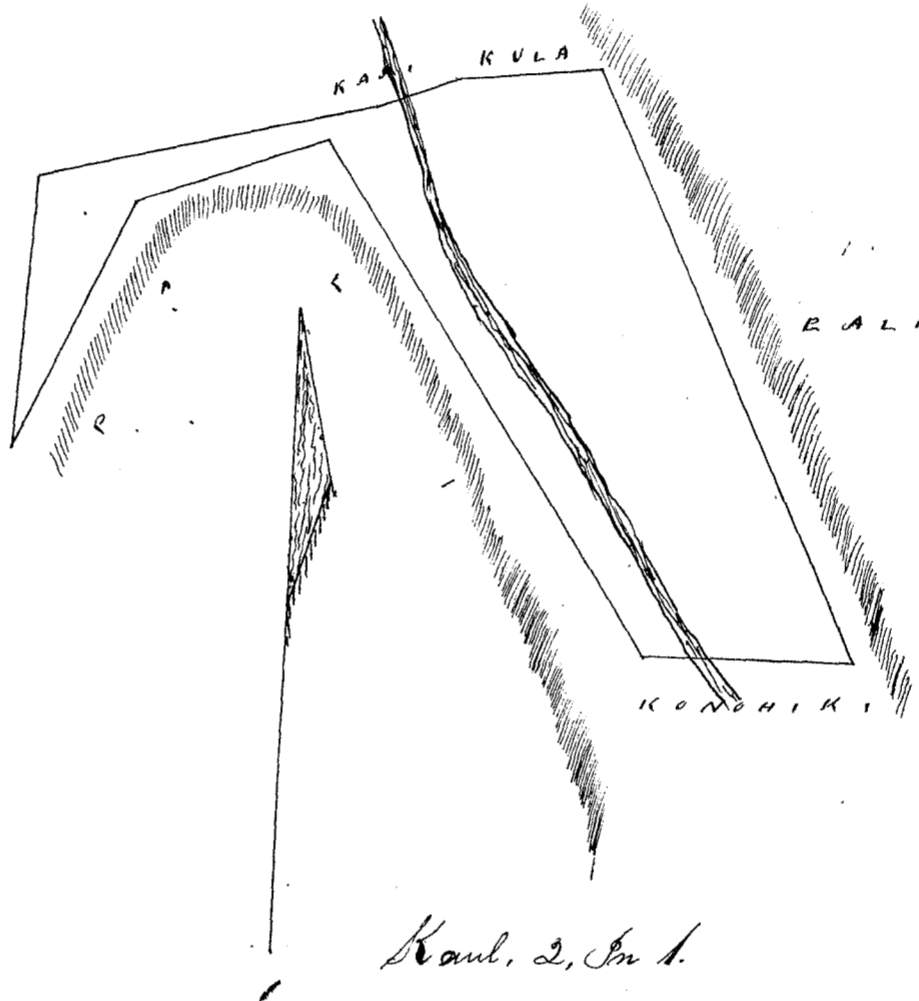

Uku Pau Loa p 5

W. L. Lee

G. M. Robertson

S. Kaulahao

J. H. Smith

Honolulu 27 Oct. 1852.

Hulu 5498 Kaunakawake

Hamakua, Maui

Ili Moialoa - Ahupuaa Uaoo, E hoomaka ke ana ma ke kahi Komohana o keia Ak 38 1/2° Hihina 167 Kh. ma ka pali, Nema 66 1/4° Hihina 251 Kh. ma ka pali, Ak 74 1/2° Hihina 286 Kh. ma ka pali, Ak 52° Hihina 405 Kh. ma ka pali, Ak 51° Nema 114 Kh. ma Komohiki, Nema 41° Nema 440 Kh. ma ka pali, Nema 88 1/4° Nema 196 Kh. ma ka pali, Ak 58° Nema 155 Kh. ma ka pali, Nema 71 1/4° Nema 252 Kh. ma ka pali a hiki i kahi i hoomaka i a maloko oia anapuni 94/100 Eka.

Wailuku, Sept. 6, 1852

John S. Lewis

Ma ana aina

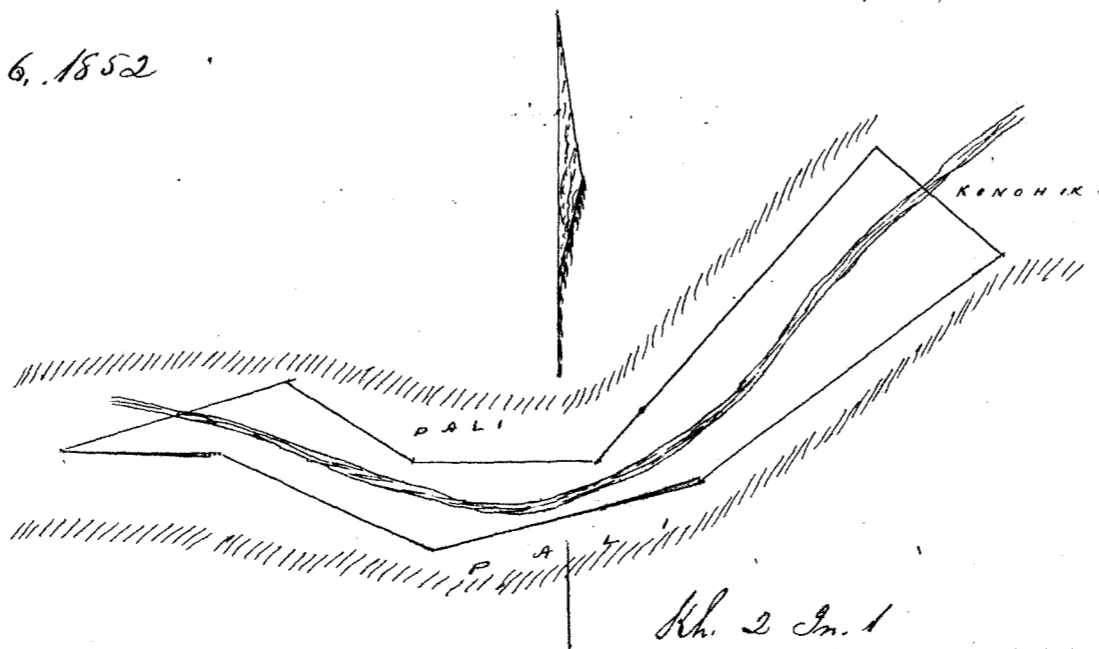

Uku Pau Loa / 4
W. L. Lee
G. M. Robertson
J. Kekaulaha
J. H. Smith

Honolulu 27 Oct 1852

Hulu 5595 Kepaa

Kamakualea Maui

Apawa I. Ili Unananiho Honopou. Chomaka ke ana ma ke hiki Akau o kua, e pili ana me Makahiki-puni; Hema 53; Komohana 430 Kaulahas, ma ke Makahiki-puni; Hema 4; Nihina 576 Kaulahas ma Kahawai; Ak. 22; Nihina 249 Kaulahas, ma ka pali; Akau 67 1/4; Nihina 411; Kaulahas ma ka pali; Akau 16; Komohana 332; Kaulahas ma ka pali; Akau 23 3/4; Komohana 313 Kaulahas ma ka hiki; ma kahi i hoomakai, a maloko oia ana-puni; 3 1/4 Eka.

Palima Chomaka ke ana ma ke hiki Nihina Akau o kua, mai ka pahu hope wa o kua Kaulahas Ak. 58 3/4; Komohana 245 Kaulahas Hema 76 1/2; Komohana 121 Kaulahas Hema 11 1/4; Nihina 44 Kaulahas, Hema 76 1/4; Nihina 38 Kaulahas Hema 30; Nihina 41 Kaulahas; Akau 71 3/4; Nihina 79 Kaulahas, Akau 15 3/4 Komohana 79 Kaulahas, a hiki ma kahi i hoomakai, a maloko oia ana-puni; 1100 Eka

Apawa II Ili o Unananiho Honopou Chomaka ke ana ma ke hiki Akau o kua, Hema 8; Nihina 848 Kaulahas ma Konoiki; Ak. 62; Kom. 474 Kh. ma Konoiki; Ak. 25 1/2; Ak. 680 Kh. ma Konoiki, a hiki; kahi i hoomakai; a maloko oia Ana-puni; 154 paa Eka.

John S. Gower
Mea ana aina

3.25
1.54

4.79 palima
0.7

4.09

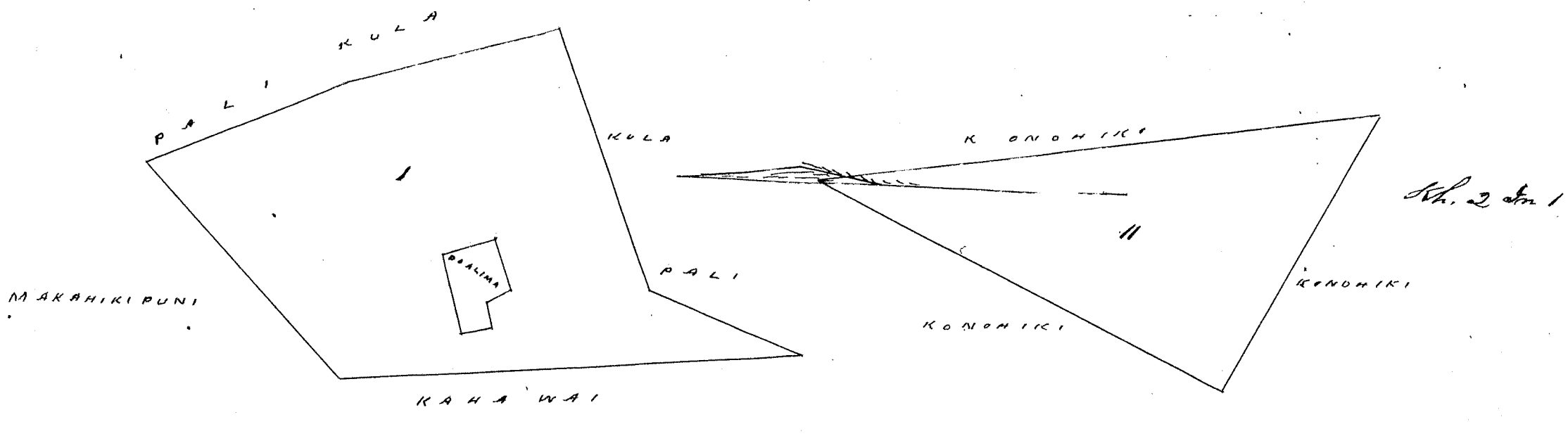

Uku Pau Loa / 1
W. L. Lee
G. M. Robertson
J. Kekaulaha
J. H. Smith

Honolulu 27 Oct 1852

Apona 3.

He Kuleana Kula Kona ma ke Ahupuaa o Ahinui, ma ka ili o Kanaha, e waiho ana ma ke awaawa o Kanaha, E ha mau mahi o keia Kula.

§ 1 He Puhala, E hoomaka ana ma ke Kihī Ak. Kom. a e holo ana, Kom. 53; Nīk 04 3. Kaul. e pili pu ana me Kōnehiki, Kom. 44 1/2; Kom. 0.62 Kaul. e pili pu ana me ke Kōnehiki Ak. 27 1/4; Kom. 0.22 Kaul. e pili pu ana me Kōnehiki, Kom. 61 Kom. 0.76 Kaul. e pili ana me ke pali: Kahi i hoomakai, Ka Ili 9/1000 Eka, = 3 mau Roda,

2/100 § 2 He Puhala ma kahi mōkupuni, ke Kōnehiki, o Aki, E hoomaka ana ma ke Kihī Ak. Nīk. a e holo ana, Kom. 15 3/4; Nīk 126 Kaul. e pili ana me Kōnehiki, Ak. 69; Kom. 189, Kaul. ma Kōnehiki, Ak. 67 1/4; Nīk 152 Kaul. e pili ana me ke Kōnehiki, i kahi i hoomakai Ka Ili 9/1000 Eka, 15 Roda,

§ 3. He Puhala E hoomaka ma ke Kihī Ak. Nīk. a e holo ana, Kom. 62 1/2; Kom. 193 Kaul. e pili ana me Kōnehiki, Kom. 81 1/4; Kom. 961 Kaul. ma ke Kōnehiki, Ak. 18, Kom. 0.54 Kaul. ma ke Kōnehiki, Ak. 61; Nīk 100 Kaul. a hiki i kela Kōnehiki, Kōnehiki, Ak. 87; Nīk 156 Kaul. e pili ana me ke pali a hiki i kahi i hoomakai Ka Ili 14/1000 Eka = 22 mau Roda

§ 5. He Wauki, e hoomaka ana ma ke Kihī Ak. Kōnehiki, a e holo ana, Kom. 6 1/2; Kom. 0.26 Kaul. e pili ana me Kōnehiki, Kom. 47 1/4; Nīk 0.94 Kaul. e pili ana me Kōnehiki, Kom. 80 1/2; Nīk 291 Kaul. e pili ana, me Kōnehiki Ak. 80, Nīk 225 Kaul. e pili ana me Kōnehiki, Ak. 20 1/4; Kom. 0.64 Kaul. e pili ana me Kōnehiki Ak. 86 1/2; Kom. 544 Kaul. e pili ana me ke pali, i kahi i hoomakai Ka Ili 45/1000 = 1 Roda D 32 mau Roda.

E 20 Roda
96 157
140
450.1. 32
708.2.10

W. H. Alexander,
Ma ana aina.

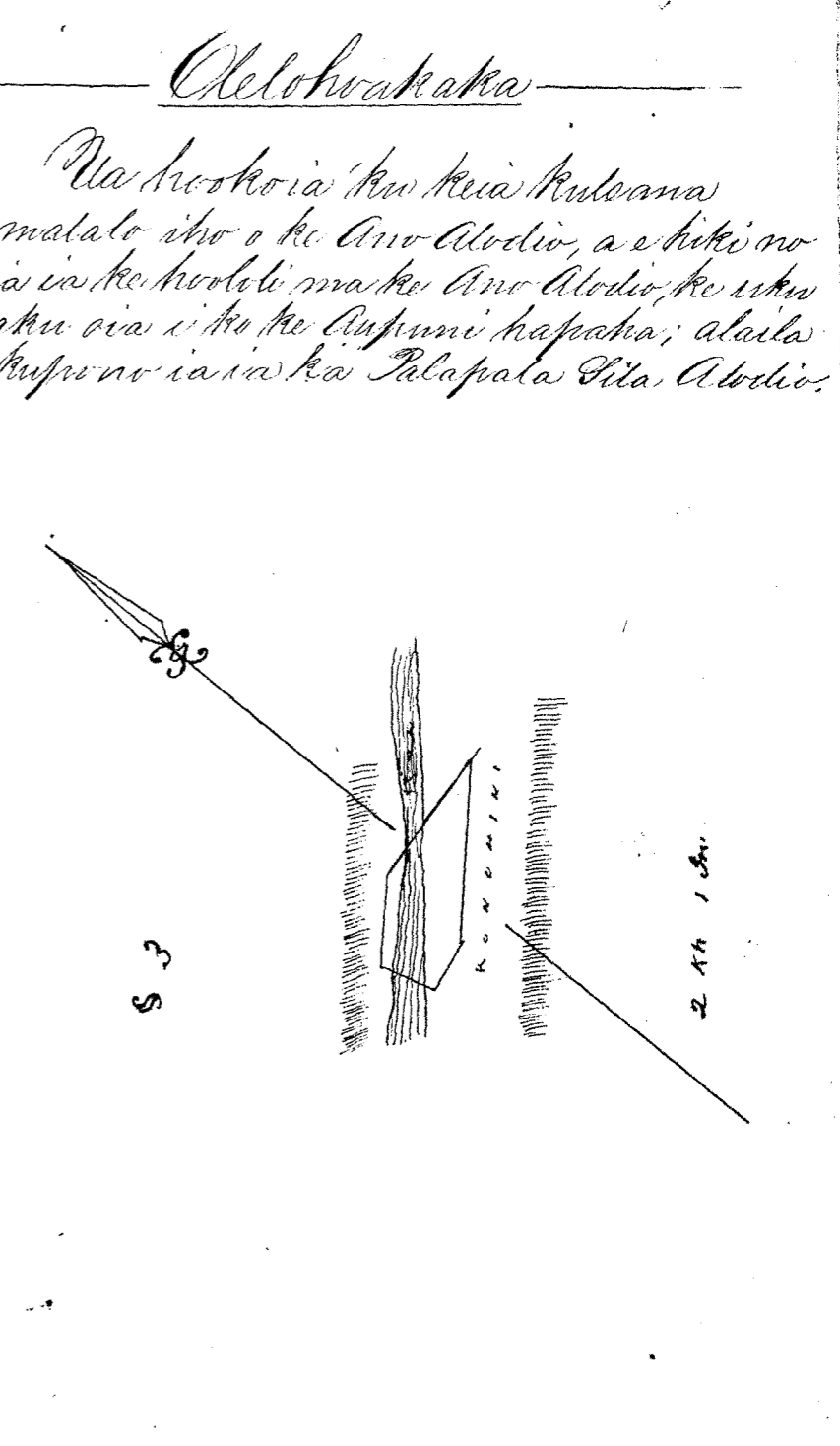
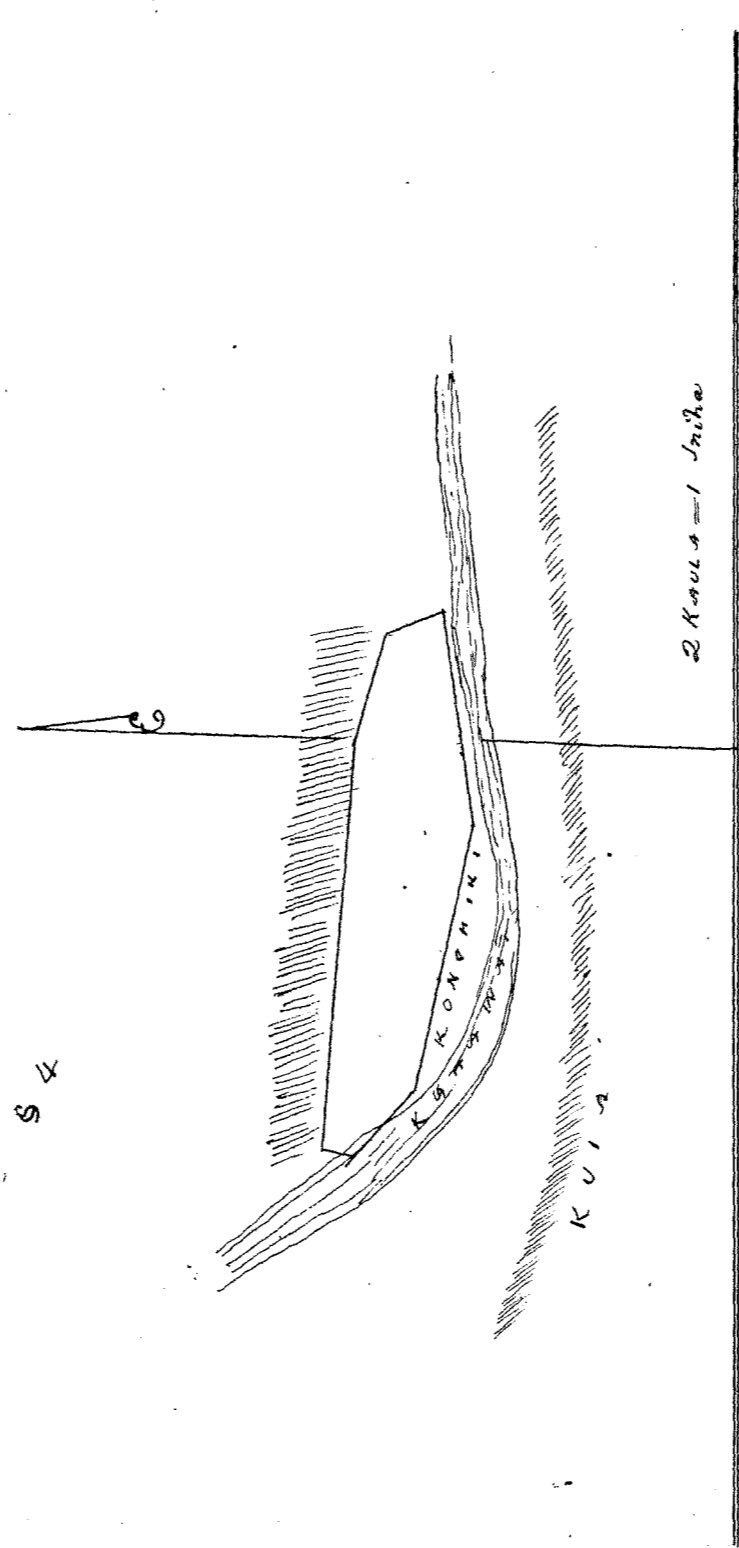
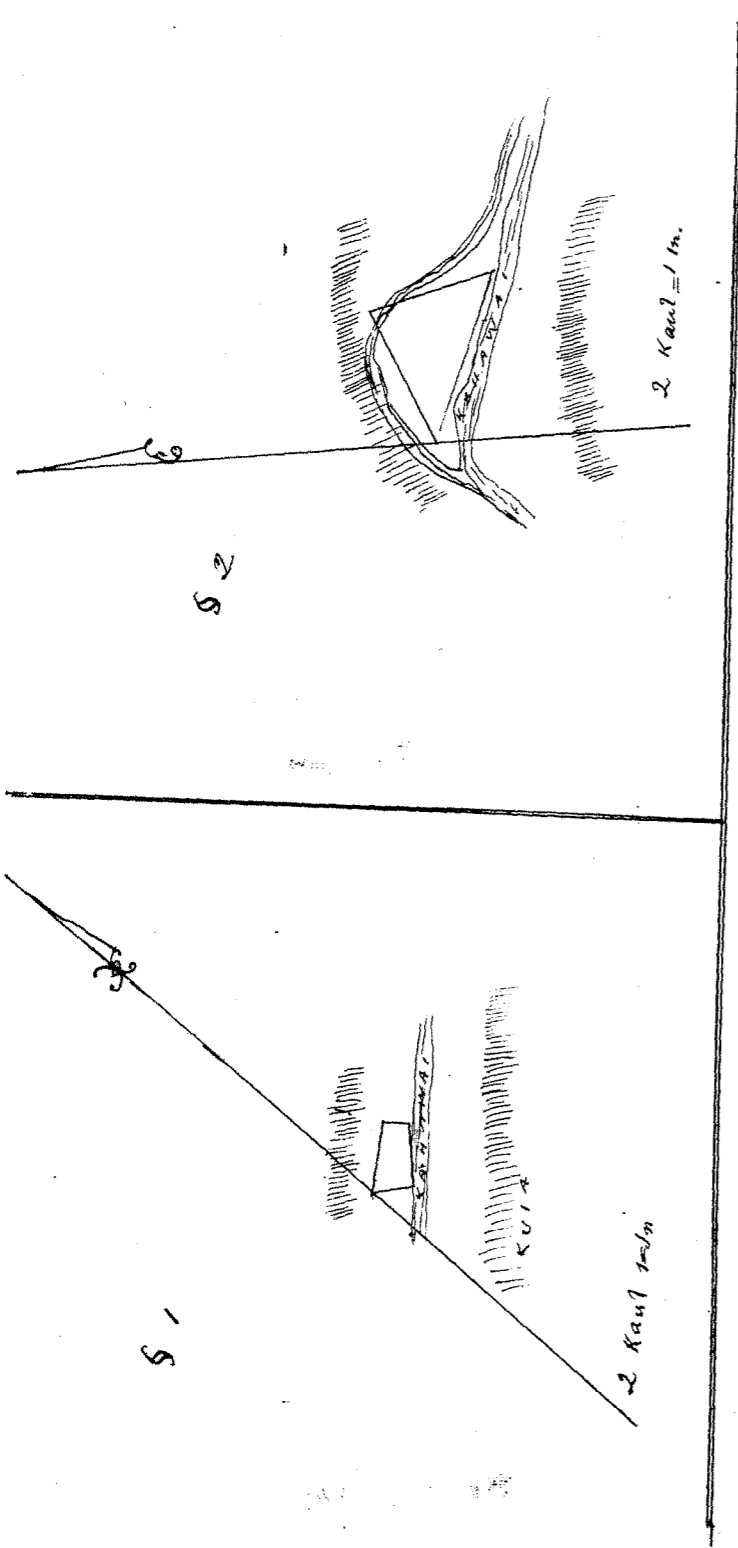

Uku Pau Loa # 2.

N. L. Lee
G. M. Robertson
J. Kekaulahas
J. H. Smith

Honolulu 4 Nov 1852

Hulu 5519 B. Napohaku

Hamakua Maui

Apuna II Iki Kapataataa, Halehaku, Chomaka ke ana ma ke Piki Akau
Keia e pili ana me ke alanui a me ke Kahawai, Hema 43° Nihina 5,43 Kaulahas
ma ka pali, Hema 45° Komohana 876 Kaulahas ma ka pali, Akau, 13 3/4° Nihina
10,40 Kaulahas ma Kahawai, a hiki ma kahi i hoomaka'i, a maloko oia
anapuni, 237/100 Eka.

Apuna I Iki ^{"Kaholo"} Halehaku, Chomaka ke ana ma ke Piki Nihina Hema
Keia, Akau 46° Komohana 448 Kaulahas, ma ka pali Akau, 52° Komohana
391 Kaulahas, ma ka pali, Hema 49° Komohana 72° Kaulahas ma Konohiki
Hema 55° Nihina, 373 Kaulahas ma Kahawai, Hema 53° Nihina 444 Kaulahas
ma Kahawai, a hiki ma kahi i hoomaka'i, a maloko oia anapuni, 39/100 Eka.

Waiuku Sept. 6, 1852

John S. Gower.
Mea ana aina.

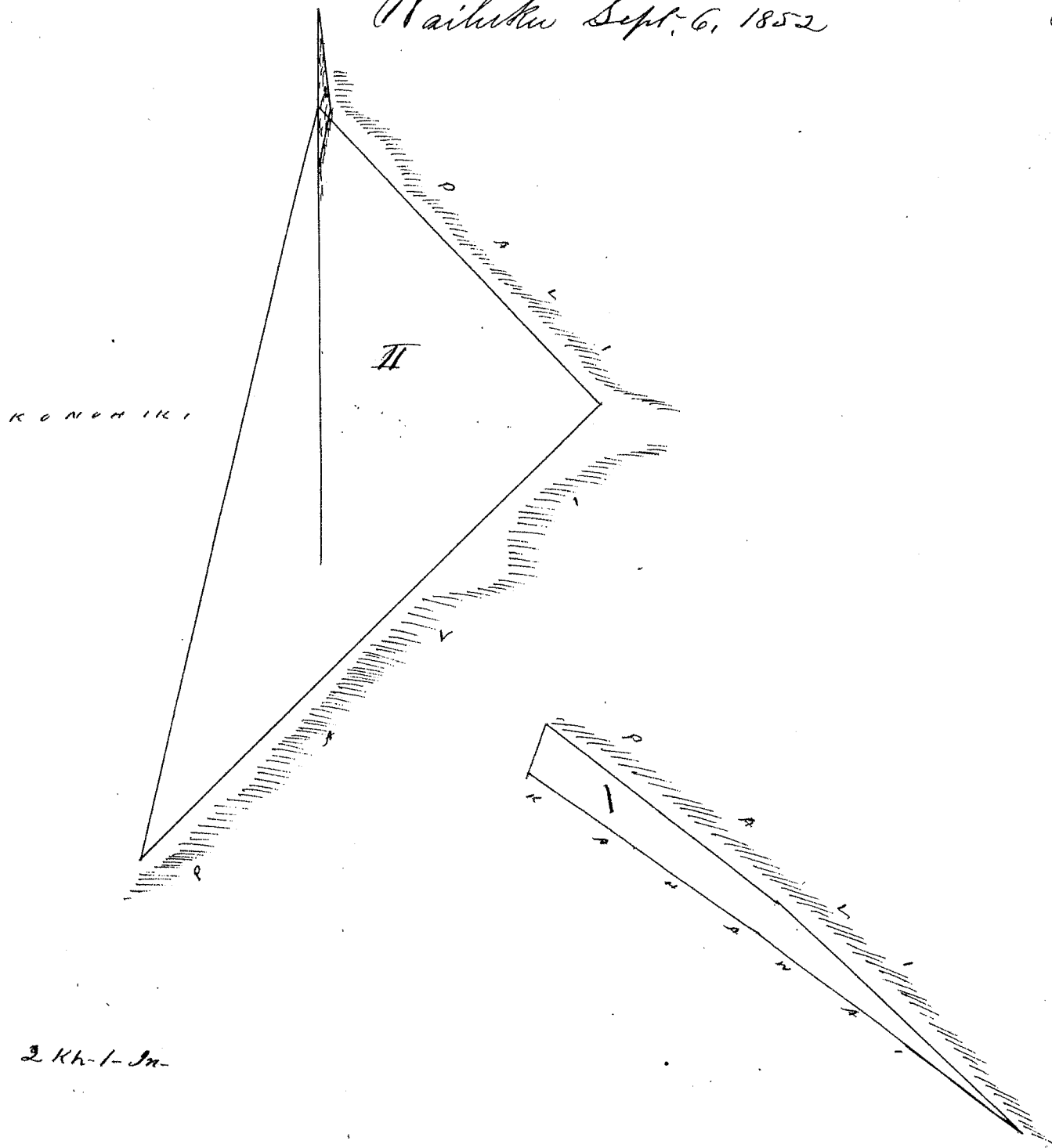

Uku Pau Loa # 6

N. L. Lee
G. M. Robertson
J. Kekaulahas
J. H. Smith

Honolulu 27 Oct 1852

Helu 5392ⁿ Makahikipuni Hamakualoa Maui

Oli Kapapanae, Honopou, E hoomaka ke ana ma ke kiki Akau o keia, Iema 76 3/4; Komohana 200 Kaulaha, ma Ke ahawai, Iema 22 Komohana 852 Kaulaha ma Ke onohiki, Akau 71; Hikina 676 Kaulaha, ma Ke onohiki, Akau 53; Hikina 430 Kaulaha, ma Ke Kepaa, Akau 52 1/4 Komohana 550 Kaulaha ma Ke ahawai, a hiki ma kahi i hoomaka'i, a maloko oia anapuni, 3 1/4 Eka.

Poalima, E hoomaka ke ana ma ke kiki^{Hikina} Akau o keia, ma ai ke kiki Hikina o ke Iema ma, Akau 56; Kom. 177 Kh. Ak. 86; Kom. 87 Kh. Iema 8; Kom. 68 Kh. Iema 86; Hik 87 Kh. Ak 8; Hik 68 Kh. a hiki ma kahi i hoomaka'i, a maloko oia anapuni, 7/100 Eka,

Waiuku Aug 25, 1852.

John S. Sower.
Mea ana aina

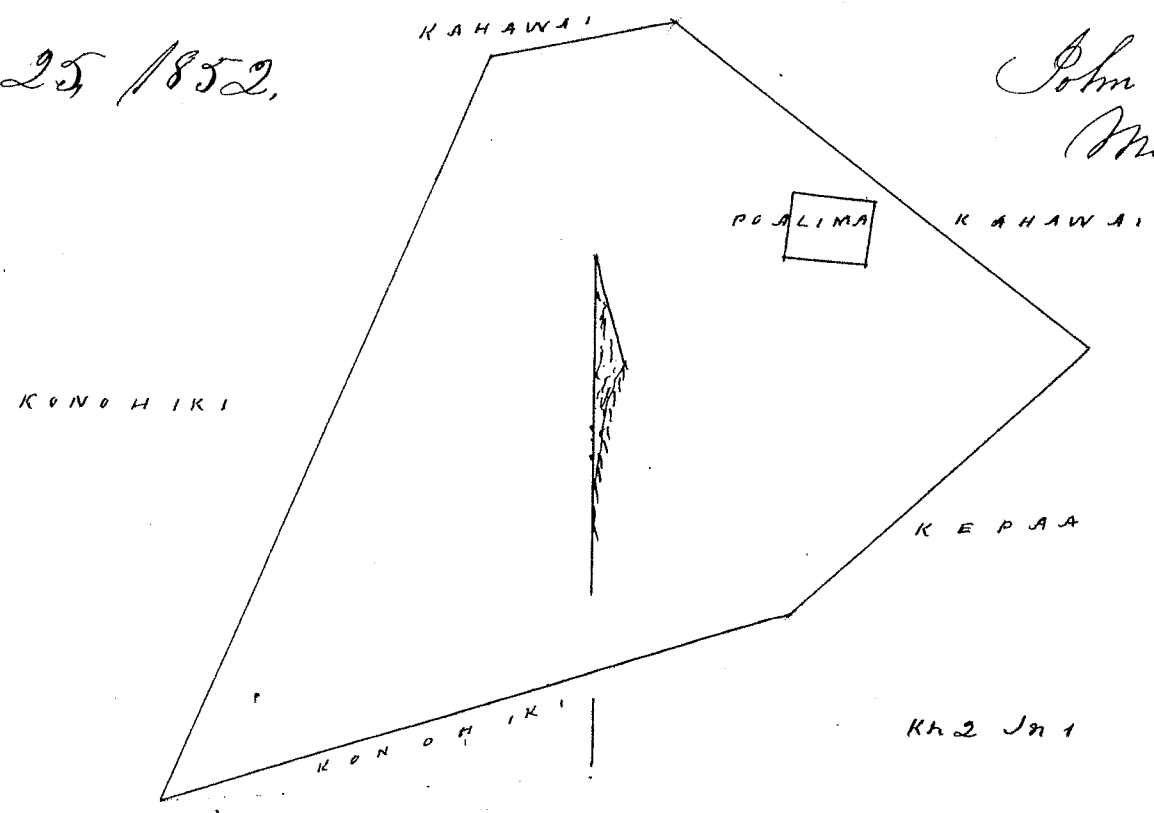

Waiuku Ima 7
W. L. Lee
G. M. Robertson
J. Kaulaha
J. H. Smith

Honolulu 27 Oct 1852

Helu 5423 Kaula Hamakualoa Maui

Apawa I. Oli Hukiho Ahupuaa Peahi E hoomaka ke ana ma ke kiki Iema o keia Akau 59, Kom. 318 Kh. ma Ke Pehupetu, Akau 46; Hikina 183 Kaula ma Ke Pehupetu, Iema 54; Hikina 328 Kh. ma Ke poalima, Iema 52; Kom. 157 Kh. ma Ke Poalima, a hiki ma kahi i hoomaka'i a maloko oia anapuni, 53/100 Eka

Apawa II Aole loa oia

Waiuku Sept. 6. 1852

John S. Sower.
Mea ana aina

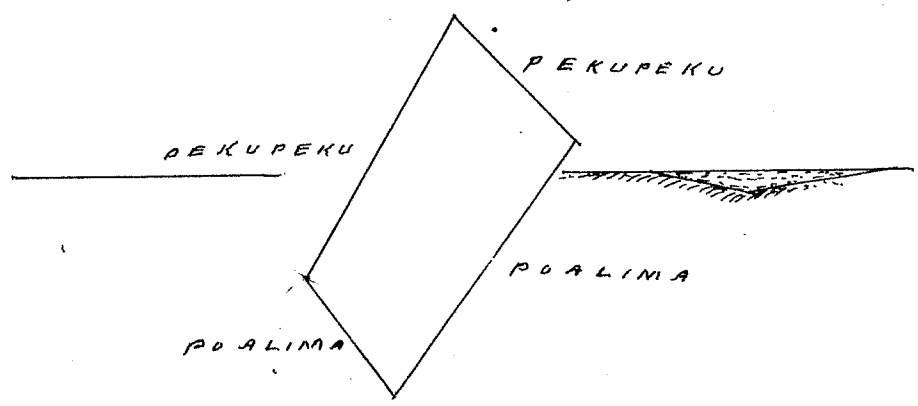

Waiuku Ima 4
W. L. Lee
G. M. Robertson
J. Kaulaha
J. H. Smith

Honolulu 27. Oct. 1852.

Hele 5459 Hewahewa (67 Pa.) Hamakua Nani

Hi o Pohaku Honouliuli, E hoomaka ke ana ma ke kiki Akau o keia Nema 4 1/2
Hikina 146 Kaulahas ma Kula, Akau 85 1/2; Hikina 30 Kaulahas ma Palima
Nema 4 1/2; Hikina 174 Kaulahas ma Palima Nema 85 1/2; Komohana, 30 Kaul.
ma Palima, Nema 4 1/2; Hikina 521 Kaulahas ma Kula, Akau 89 1/4; Kom. 425
Kaulahas ma Pali Nema 42 1/2 Komohana 326 Kaulahas, ma Konohiki; Nema
88 1/2; Hikina 737 Kaulahas ma Kahawai; Akau 51 Hikina 692 Kaulahas
ma Kula, Akau 54; Komohana 951 Kaulahas ma Kula, a hiki ma Kahi i
hoomakahi, a maloko oia anapuni; 499/100 Eka.

"Wailuku Nani Sep. 6 1852" John S. Gower
Ma ana aina

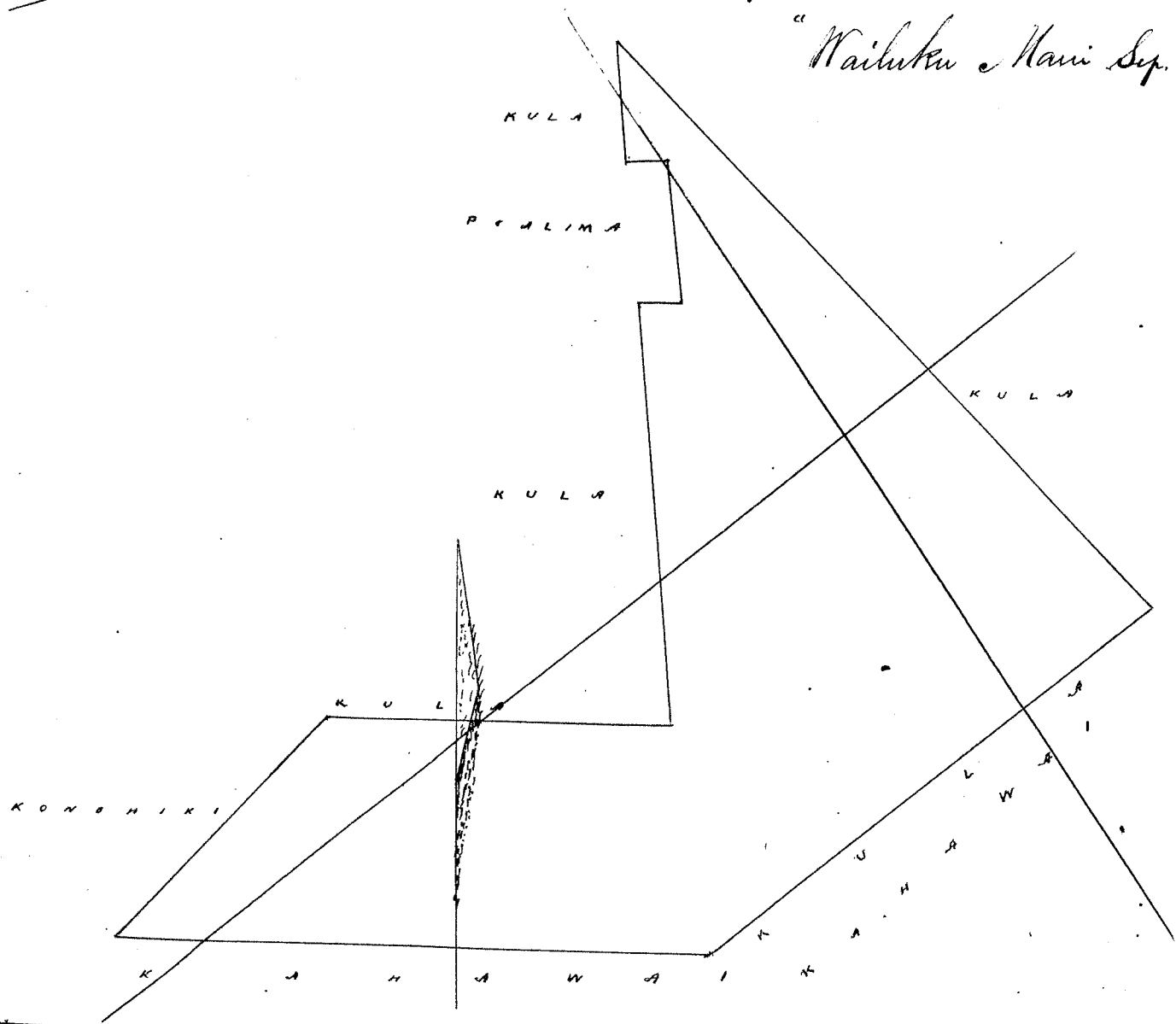

Olelo hoomakahi.
Ua hewa ke ana ana i keia kii Aina
o Hewahewa, a ua huna hou o John
S. Gower i kii hou, nolaila ua hooloia
keia kii a me ka moolelo pu, Aia
ka pono ma ka waa 67, o keia
Eka.
J. Kekaulaao-

Nana iwa 67 617

Uku Pau Loa 67

Honolulu 27 Oct. 1852

Hele 6455 Koaha Hamakua Nani

Apana I. Hi o Koahe, Pauwaha. E hoomaka ke ana ma ke kiki Hikina o keia,
Nema 83 1/4 Komohana 420 Kaulahas ma ka pali, Nema 53 1/4 Komohana 249 Kaulahas ma Pali,
Nema 37; Hikina 128 Kaulahas ma ka pali, Akau 30; Hikina 305 Kaulahas ma ka Kahawai
Akau 66 1/2; Hikina 340 Kaulahas ma ke Kahawai, a hiki ma Kahi i hoomakahi
a maloko oia anapuni; 38/100 Eka.

Apana II aole loa,
Wailuku, Sept. 10, 1852

John S. Gower
Ma ana aina

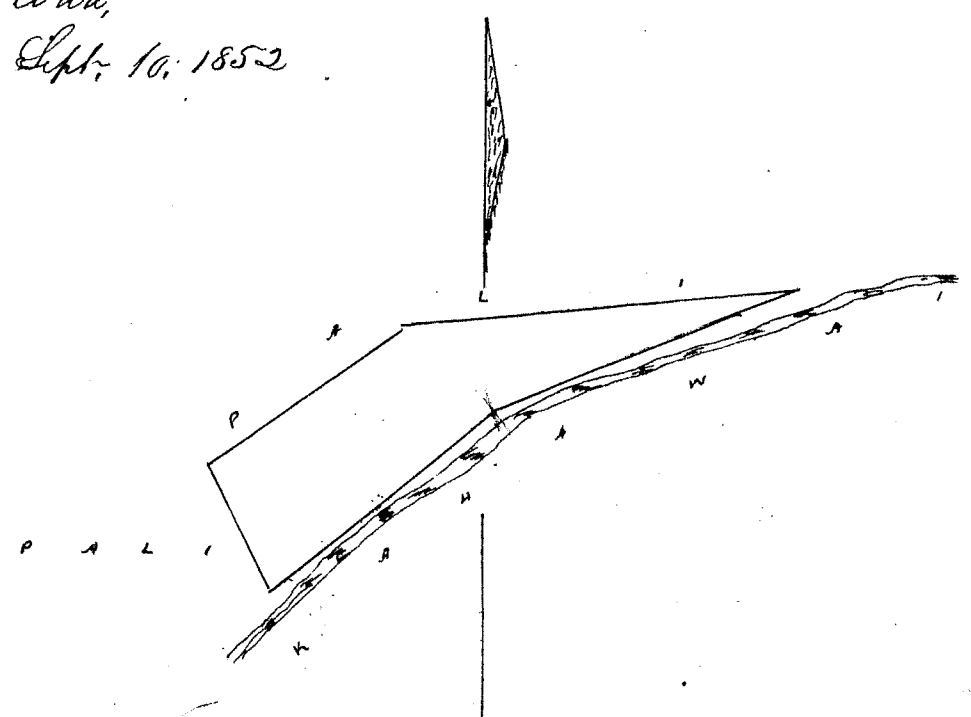

Uku Pau Loa # 4
W. L. Lee
G. M. Robertson
J. Kaulahao
J. H. Smith

Honolulu 27 Oct 1852

Hulu 5506 Kaaukai

Hamakua, Maui

Apana 1 Ili o Uluhaha, Halehaku E hoomaka ke ana ma ke Pahi a Kau o Keia
Hema 8 Komohana 354 Kaulahao ma ka Pali Hema 6 1/4 Hikiwa 227 Kaulahao ma Kula
Hema 16 Hikiwa 125 Kaulahao ma ka Pali Hema 65 Komohana 149 Kaulahao ma Kula
Hema 2 Hikiwa 583 Kaulahao ma ka Pali Hema 81 Hikiwa 56 Kaulahao ma ke Koonohiki
Akau 45 1/2 Hikiwa 400 Kaulahao ma ka Pali Akau 28 1/4 Hikiwa 384 Kaulahao ma
ka Pali Akau 1 Komohana 291 Kaulahao ma ka Pali Akau 50 1/4 Komohana 370 Kaulahao
ma ka Pali Akau 72 Komohana 353 Kaulahao ma ka Pali a hiki ma ka
hi i hoomaka i a maloko via anapuni 5 16/100 Eka

Apana 11 Ili o Puniawa Halehaku E hoomaka ke ana ma ke Pahi Komohana
o Keia Hema 13 1/2 Hikiwa 304 Kaulahao ma Pali Akau 77 Hikiwa 231 Kaulahao ma ke
Koonohiki Akau 4 Komohana 461 Kaulahao ma ka Pali Hema 46 Komohana 199
Kaulahao ma ke Koonohiki Hema 56 Komohana 137 Kaulahao ma ke Koonohiki
a hiki ma ka hi i hoomaka i a maloko via anapuni 9 1/100 Eka

Wailuku Aug 26 1852

John S. Lowes
Mea Ana aima

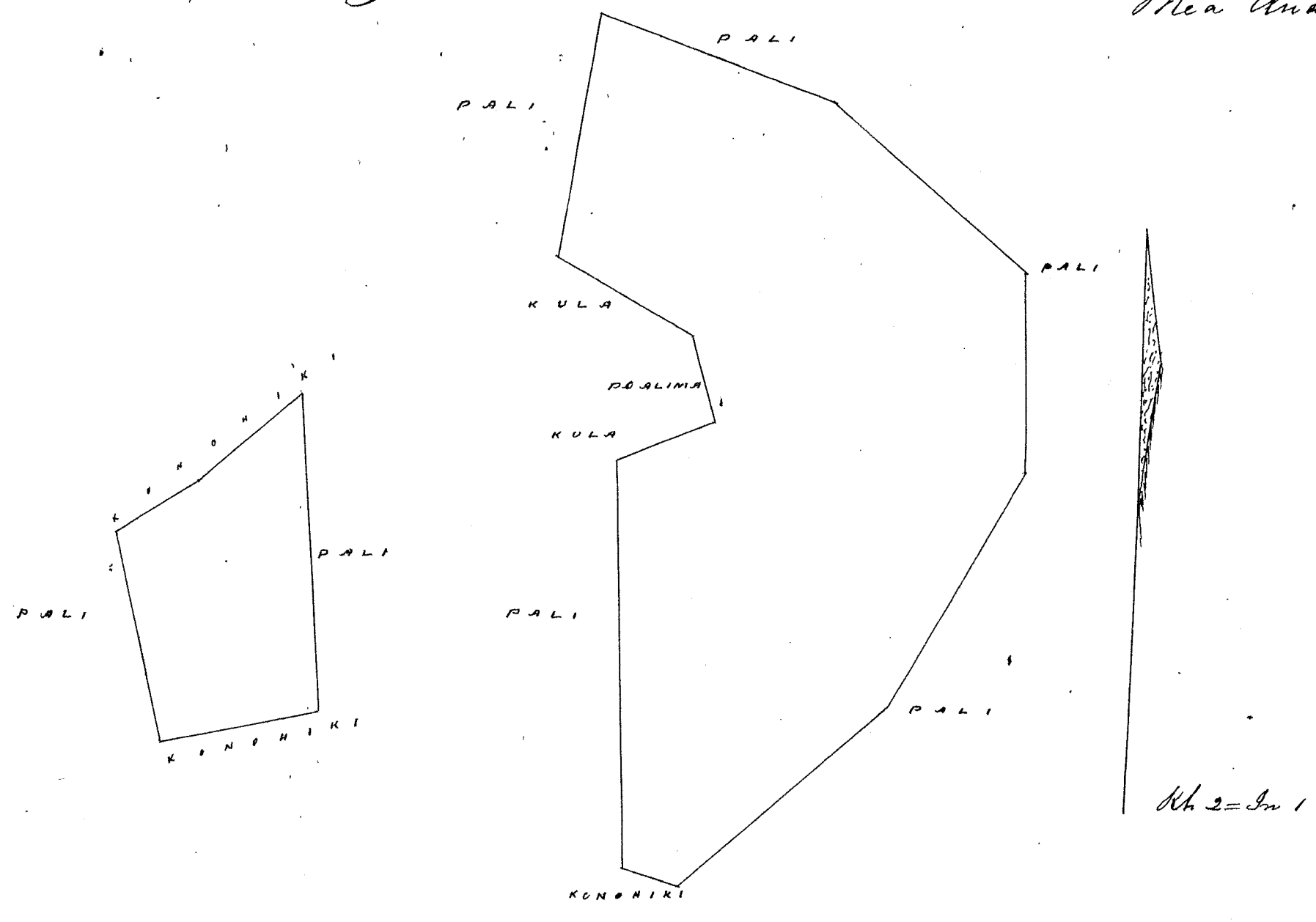

Uku Pau Loa # 8
W. L. Lee
G. M. Robertson
J. Kaulahao
J. H. Smith

Honolulu 27 Oct 1852

Heleu 3905 Kuuwa

Hamakualoa Maui

Apana I. Ili o Hukihiko Ahupuaa. Peahi, E hoomaka ke ana ana ma ke kiki Komohana Hema. heia, Akau 18 1/2 Komohana 231 Kaulahas ma ka Pali, Akau 85 1/2 Hihina 119 Kaulahas ma ke Kula, Akau 58 Hihina 405 Kaulahas ma ka Poalima Hema, 5 3/4 Komohana 460 Kaulahas ma ke Kahawai Akau 87 1/2 Komohana 353 Kaulahas ma ka Konohiki, a hiki i kahi i hoomaka'i, a maloko oia anapuni 1 27/100 Eka

Apana II Aole Looa oia

Wailuku Sept. 6, 1852

John S. Lower,
Mea ana aina

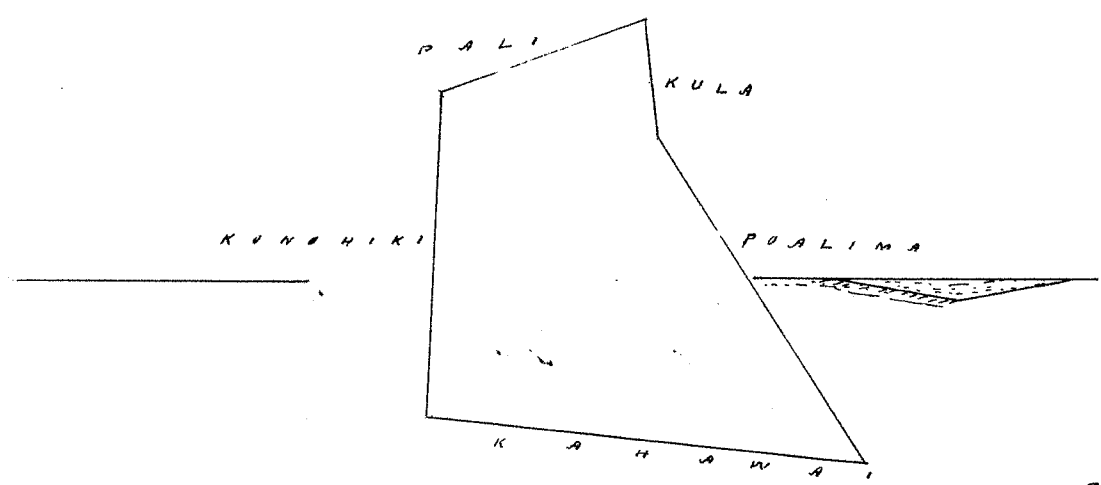

2 Kk. = 1 In.

Uku Pau Looa # 5.
W. L. Lee
G. M. Robertson
J. Kekaulahas
J. H. Smith

Honolulu 27 Oct 1852

Heleu 6411 Keilaua

Hamakualoa Maui

Ili o Keipapa Ahupuaa Keaaula. E hoomaka ke ana ana ma ke kiki Hihina Hema. heia i pili ana me Kapoka, Akau 15 Komohana 361 Kaulahas ma ka pali, Akau 86 3/4 Komohana 256 Kaulahas ma Konohiki, Hema 15 Hihina 361 Kaulahas ma Kahawai, Hema 86 3/4 Hihina 256 Kaulahas ma ke Kapela, a hiki ma kahi i hoomaka'i, a maloko oia anapuni 7/10 Eka.

Wailuku, Sept. 6, 1852

John S. Lower,
Mea ana aina,

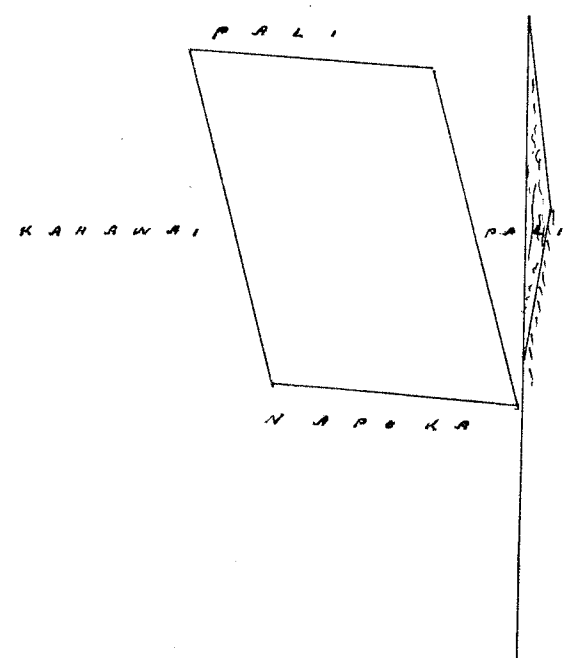

Uku Pau Looa # 4
W. L. Lee
G. M. Robertson
J. Kekaulahas
J. H. Smith

Honolulu 27 Oct 1852

Helu 7972 Kaluahinerui

Hamakualoa Maui

Ili o Kapua Ahupuaa Kealiiki Chomaka ke ana ma ke kiki Komohana Hema o keia Akau 8° Komohana 187 Kaulahas ma Kula. Akau 8 1/2° Hikiina 174 Kaulahas ma Kula, Hema 5° Hikiina 198 Kaulahas ma Kula. Hema 8 1/2° Komohana 162 Kaulahas ma Kula, a hiki ma kahi i hoomaka'i, a maloko oia anapuni 3 2/100 Eka.

Wailuku Sept. 6. 1852.

John. S. Gower
Mea ana aina

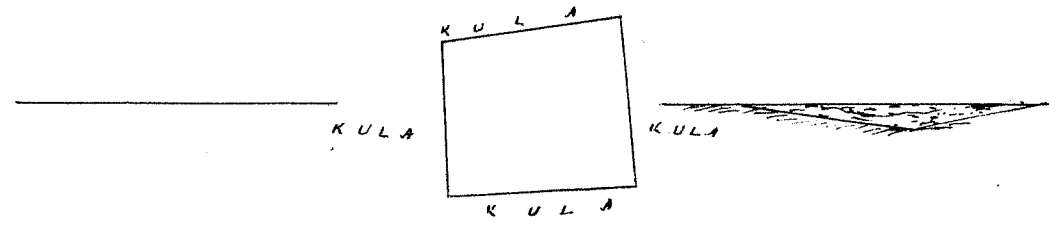

Uku Pau Loa # 4
W. L. Lee
G. M. Robertson
J. Kikaulahas
O. H. Smith

Honolulu 27 Oct 1852

Helu 3905 Keonohia

Hamakualoa Maui

Apana II Ili Pochiki Kaupakulua Komohana Chomaka ke ana ma ke kiki Komohana Hema o keia a fili ana me Keanehoalani Akau 80° Hikiina 59 Kaulahas ma ke Keanehoalani, Hema 6° Hikiina 40 Kaulahas ma ke Keanehoalani, Hema 8 1/2° Hikiina 78 Kaulahas ma ke Keanehoalani, Hema 1 1/4° Komohana 94 Kaulahas ma ke Kea Palima, Hema 3 1/2° Komohana 66 Kaulahas ma ke Keanehoalani, Hema 4 8/12° Hikiina 52 Kaulahas ma ke Keanehoalani, Hema 8 1/2° Hikiina 132 Kaulahas ma ke Keanehoalani, Akau 4 3/4° Komohana 222 Kaulahas ma Kahawai, Akau 6 1/2° Komohana 120 Kaulahas ma Kahawai, Akau 3 1/2° Hikiina 172 Kaulahas ma ka pali a hiki ma kahi i hoomaka'i a maloko oia anapuni 4 2/100 Eka.

Apana 1 & 2 Aole loa oia.
Wailuku, Sept. 6. 1852,

John. S. Gower,
Mea ana aina,

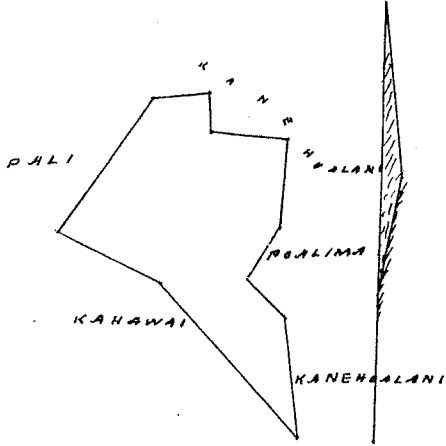

Kaulahas 2 Inika 1

Uku Pau Loa # 4
W. L. Lee
G. M. Robertson
J. Kikaulahas
O. H. Smith

Honolulu 27 Oct 1852

Helu 6234 Koleamoku

Hamakualoa Maui

Ili o Kaluahinerui Ahupuaa o Apana Chomaka ke ana ma ke kiki Komohana o keia, a fili ana me Keanakahi Akau 66° Hikiina 204 Kaulahas ma ke Keanakahi, Hema 17° Hikiina 256 Kaulahas ma ka pali maluna, Hema 66° Komohana 204 Kaulahas ma ke Keonohiki, Akau 17° Komohana 256 Kaulahas ma ka pali malala a hiki ma kahi i hoomaka'i, a maloko oia anapuni 5 3/100 Eka.

Wailuku Sept 6 1852.

John. S. Gower,
Mea ana aina

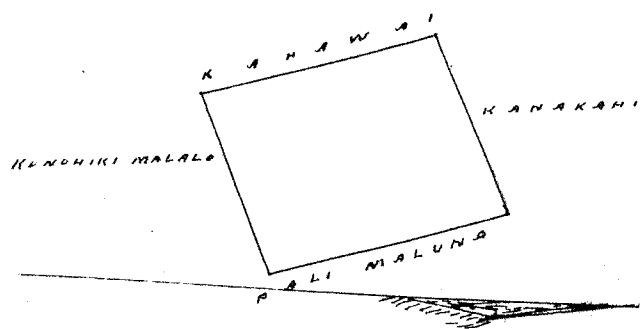

Kaulahas 2 Inika 1.

Uku Pau Loa / 4

W. L. Lee
G. M. Robertson
J. Kekaulahao
J. H. Smith

Honolulu 27 Oct 1852

Keleu 5521¹³ Kamewaa

Hamakua, Maui

Mi o Halaula Komopou Chomaka ke ana ma ke kahi Nema o keia, e pili ana me Nakaikua ana Akau 56 1/2; Nihina 313 Kaulahas ma ke Nakaikua ana Akau 30 1/2; Nihina 442 Kaulahas ma ke Pali Nema 76 3/4 Komohana 484 Kaulahas ma ke Komohiki, Nema 2 Komohana 442 Kaulahas ma ke Pali a hiki ma kahi i hirmaka i, a maloko oia anapuni. 1 33/100 Eka.

Wailuku, Augate, 26. 1852

John S. Sower.
Mea ana aina

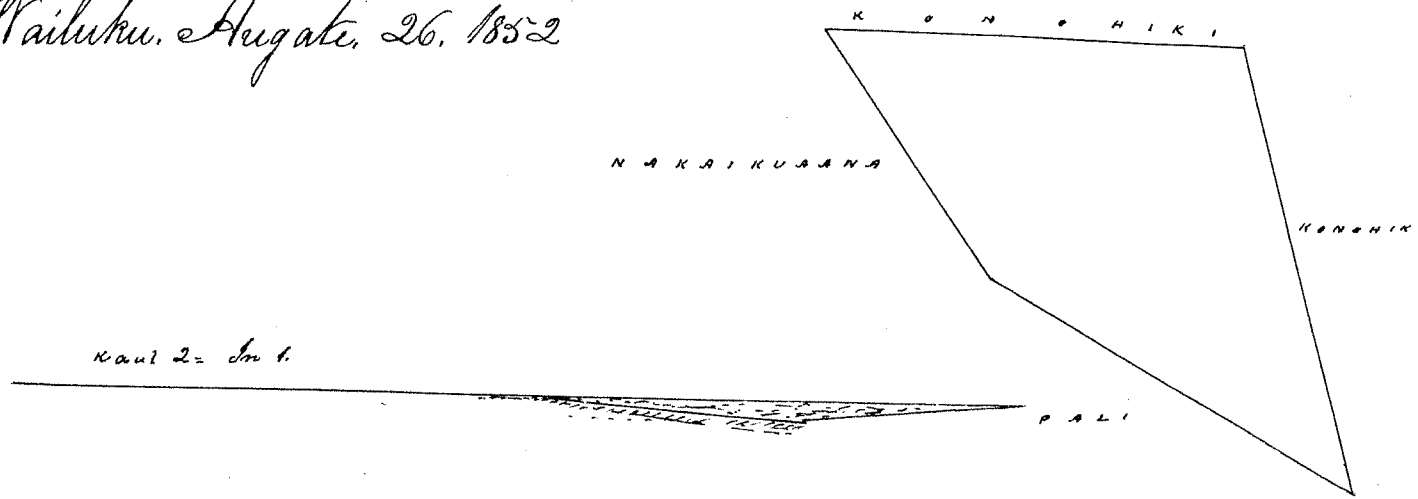

Uku Pau Loa / 5

W. L. Lee
G. M. Robertson
J. Kekaulahao
J. H. Smith

Honolulu 27 October 1852

Keleu 5499 J. Kauhi

Hamakua, Maui

Apana II Mi Puniawa Katakaki. Chomaka ke ana ma ke kahi Akau o keia Nema 67; Nihina 226 Kaulahas ma ke Komohiki, Nema 31; Nihina 130 Kaulahas ma ke Pali, Nema 34; Nihina 167 Kaulahas ma ke Pali, Akau 76 3/4; Komohana 288 Kaulahas ma ke Pali; Akau 19 1/4; Komohana 280 Kaulahas ma ke Pali, a hiki ma kahi i hirmaka i, a maloko oia anapuni 53/100 Eka

Apana I Ua mahi ole.

Wailuku, Sept. 10. 1852.

John S. Sower
Mea ana aina

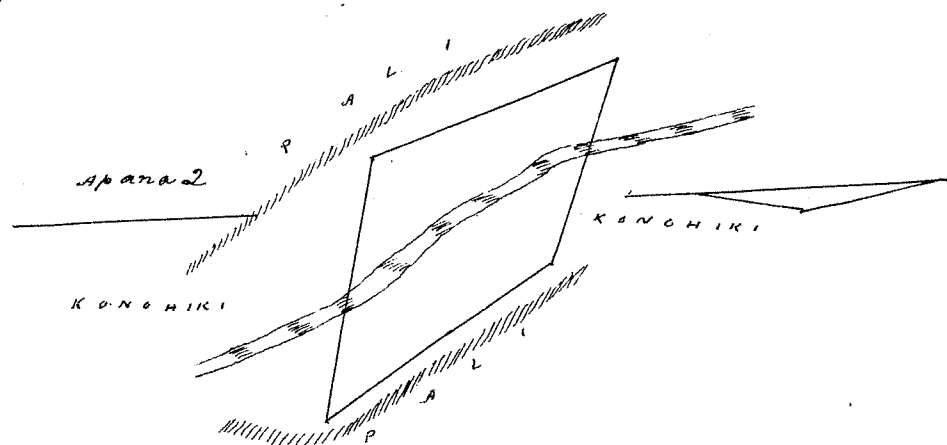

Uku Pau Loa / 4

W. L. Lee
G. M. Robertson
J. Kekaulahao
J. H. Smith

Honolulu 27 Oct 1852.

Hulu 3905 Piopia

Hamakua Maui

Ili Komohala Kalihaku, E hoomaka ke ana ma ke kahi Hema o kua Akau 38 3/4; Nihina 190 Kaulahas ma ka pali. Akau 13 Nihina 160 Kaulahas ma ka Pali. Akau 28 1/4; Komohana 207 Kaulahas ma ka pali Akau 42 1/2 Komohana 237 Kaulahas ma ka Pali. Akau 80 3/4; Nihina 434 Kaulahas a hiki i kela arao Hema 15 1/4; Komohana 635 Kaulahas ma Kahawai. Hema 54 Komohana 180 Kaulahas ma Kahawai a hiki ma kahi i hema ka ai, a maloko oia anapuni, 1 Eka.

Wailuku Sept 6 1852

John S. Tower
Mea ana aina

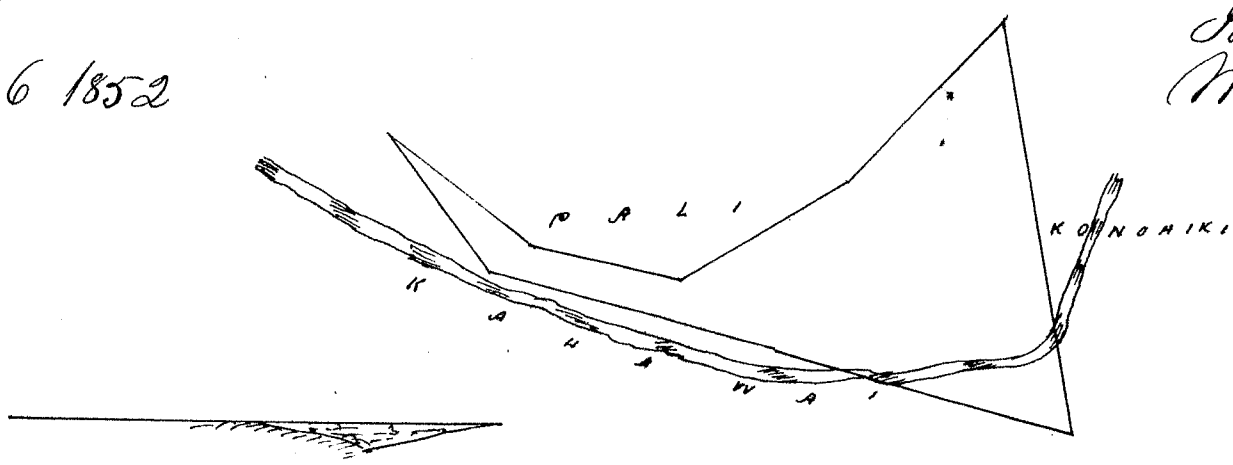

2 Kh 1 In.

Uku Pau Loa # 5.
W. L. Lee
G. M. Robertson
J. Kaulahas
J. H. Smith

Honolulu 27 Oct 1852

Hulu 5392 Kauihi

Hamakua Maui

Apana 1. Ili Kaluanui Ahupuaa Komohala. E hoomaka ke ana ma ke kahi Akau o kua e pili ana ma ka pali. Hema 23 1/2; Nihina 331 Kaulahas ma ka Pali. Hema 32 Komohana 282 Kaulahas ma ka pali Akau 83 1/2 Komohana 75 Kaulahas a hiki i kela arao Akau 21 Nihina 169 Kaulahas ma ka pali. Akau 5 1/4; Komohana 350 Kaulahas ma ka pali. Akau 57 1/2; Nihina 59 Kaulahas. a hiki i kela arao, a hiki ma kahi i hoomaka'i, a maloko oia anapuni, 56/100 Eka.

Apana 2. Aole loa. Nihiluhile paha

Wailuku Augate 24 1852.

John S. Tower
Mea ana aina

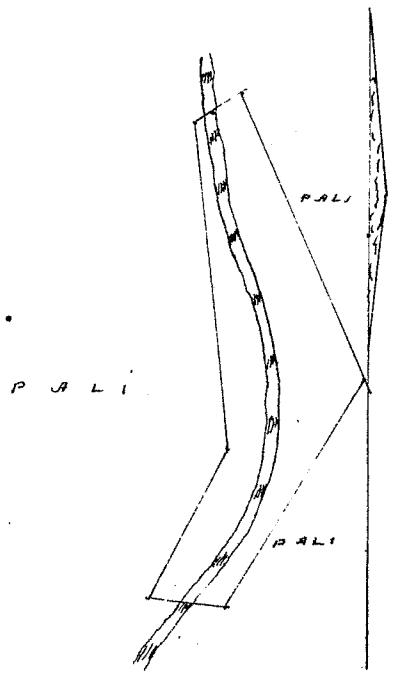

2 Kh. 1 In.

Uku Pau Loa # 4
W. L. Lee
G. M. Robertson
J. Kaulahas
J. H. Smith

Honolulu, 27 Oct 1852.

Kulu 5459 Iohina

Hamakualoa, Maui

Apana 1 Mahale 1. Ili Oha Ehomaka ke ana ma ke kiki Hikina o keia e pili ana me ke Puhala, Hema 29 1/2 Komohana 219 Kaulahas ma ka auwai, Akau 49 Komohana 193 Kaulahas ma ka Pali, Akau 35 Hikina 212 Kaulahas, ma ka Palalima, Hema 70 1/4 Hikina 169 Kaulahas ma Kula ma kahi i homaka'i, a maloko oia anapuni, 4 1/2 Eka.

Mahale 2. Ehomaka ke ana ma ka hala kiki Hikina Hema o keia, Akau 60 1/4 Hikina 198 Kaulahas ma ka auwai Hema 80 3/4 Komohana 200 Kaulahas ma Konoiki Hema 28 1/4 Komohana 246 Kaulahas ma ka pali, Akau 79 1/4 Hikina 297 Kaulahas ma ke Konoiki, ma kahi i homaka'i a ma loko oia anapuni 46 1/2 Eka

Apana 11 Aole loaa,
Wailuku August 11, 1852

John S. Lower
Mea ana aina

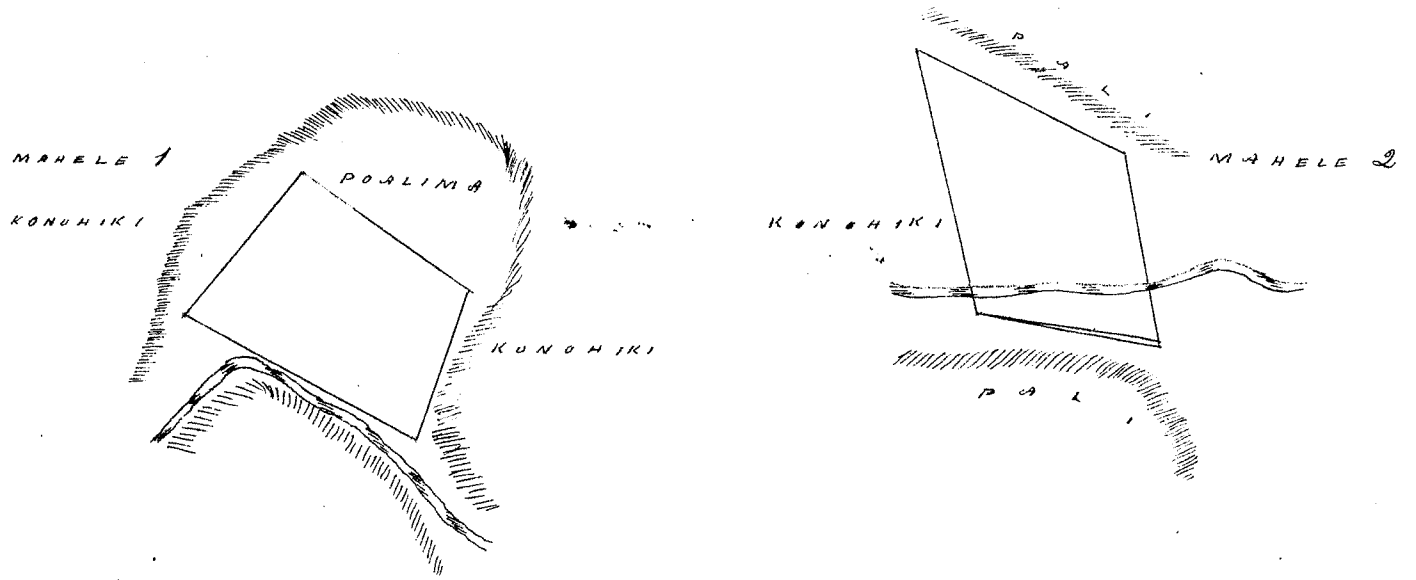

Uku Pau Loa # 4
W. L. Lee
G. M. Robertson
J. Kekaulahas
J. H. Smith

Honolulu 27 Oct 1852

Kulu 4753 Maiola

Hamakualoa, Maui.

Apana 1. Ili Kalauololo Halehaku. Ehomaka ke ana ma ke kiki Komohana Hema o keia Akau 4 1/2 Kom. 3.00 Kk. Peahi. Ak. 86 1/2, Tike 99 Kk Kula. Hema 7. Tike 297 Kk Pali. Hema 85 1/2 Kom. 104 Kk Kula. a hiki ma kahi i homaka'i, maloko oia anapuni, 3 1/2 Eka.

Apana 11 1/2 Ua mahi ole oia
Wailuku, Sept. 6, 1852

John S. Lower
Mea ana aina

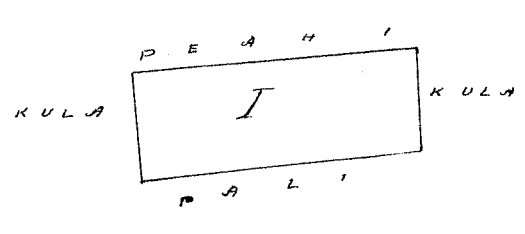

Kk. 2 In. 1

Uku Pau Loa # 4
W. L. Lee
G. M. Robertson
J. Kekaulahas
J. H. Smith

Honolulu 27 Oct 1852

Apana I. Ili Papalua Halihaku. Chomaka ke ana ma ke kahi Akau o keia, Hema 25° Komohana 169 Kaulahas, ma ke pali, Hema 21° Komohana 175 Kaulahas, ma ke Pali, Hema 67 Hikina 50 Kaulahas ke Mau Ii. Akau 62 Hikina 159 Kaulahas ma Kahawai, Akau 11° Hikina 60 Kaulahas ma ke Kahawai, Akau 80 Komohana 45 Kaulahas ma ke Poalima, Akau 11° Komohana 49 Kaulahas ma ke Poalima Hikina hono, 40° Kaulahas, ma ke Poalima, Akau 10° Komohana 127 Kaulahas, ma Kahawai, a hiki ma kahi i hoomaka'i, a maloko oia anapuni, 21/100 Eka,

Wailuku Aug. 26 1852.

John S. Lower
Mea ana aina

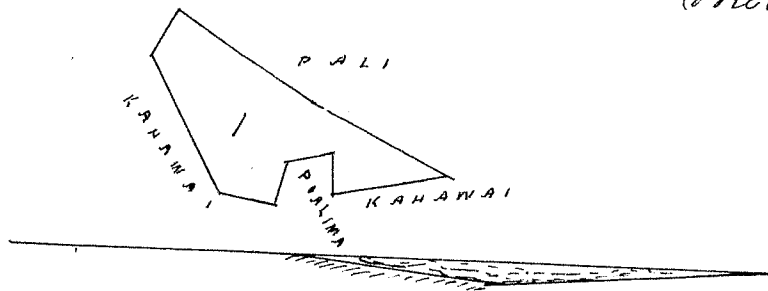

Uku Pau Ioa # 4
W. L. Lee
G. M. Robertson
J. Hekeaulahas
J. H. Smith

Honolulu 27 Oct 1852

Apana I Ili Puniwa Halihaku Chomaka ke ana ma ke kahi Hikina Akau o keia Hema 16° Komohana 281 Kaulahas ma Kula, Akau 33 1/2° Komohana 260 Kaulahas, ma ke pali Akau 77 Hikina 231 Kaulahas ma ke Komohiki a hiki ma kahi i hoomaka'i, a maloko oia anapuni, 28/100 Eka,

Apana II Mahale I Ili o Kawaiiki Halihaku. Chomaka ke ana ma ke kahi Komohana o keia Hema 58 1/2° Hikina 189 Kaulahas, ma Kula, Akau 36 1/4° Hikina 139 Kaulahas ma Komohiki, Hema 86 3/4° Komohana 244 Kaulahas, ma ke pali, a hiki i kahi i hoomaka'i, a maloko oia anapuni, 12/100 Eka

Mahale II Chomaka ke ana ma ke kahi Akau o keia Hema 4 1/2° Komohana 464 Kaulahas ma ke pali, Hema 76° Hikina 174 Kaulahas ma Komohiki Akau 17 Komohana 525 Kaulahas ma ke pali, a hiki ma kahi i hoomaka'i, a maloko oia anapuni, 44/100 Eka,

Wailuku, Aug. 26, 1852.

John S. Lower
Mea ana aina

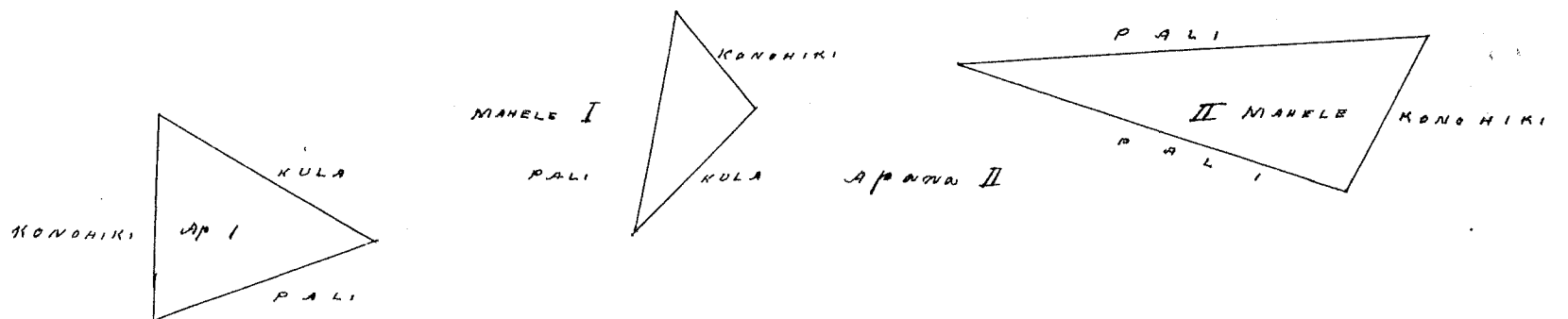
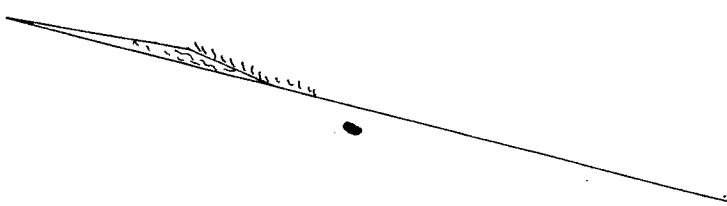

Uku Pau Ioa # 4
W. L. Lee
G. M. Robertson
J. Hekeaulahas
J. H. Smith

Honolulu 27 Oct 1852.

Kulu 5512 Kouani

Hamakuahoa Maui

Apana I. Mahale I Ili Papane, Ahupuaa Kalohaku, E hoomaka ana ma ke kahi Hikitina o keia Heema 49 1/2 Komohana 336 Kaulahas ma ke Komohiki, Akau 15 Komohana 428 Kaulahas ma ke Komohiki Heema 62 Hikitina 418 Kaulahas ma Kahawai, a hiki ma kahi i hoomaka i, maloko oia anapuni 6/10 Eka

Mahale II E hoomaka ke ana ma ke kahi Komohana Akau o keia, Heema 7 Komohana 278 Kaulahas ma Komohiki, Akau 80 Komohana 368 Kaulahas ma ka pali, Akau 6 1/2 Hikitina 448 Kaulahas ma Kahawai, a hiki ma kahi i hoomaka i, a maloko oia anapuni 5/10 Eka.

Apana II Aole mai oia

Hulu Sept 6 1852

John S. Gower.
Mea ana aia

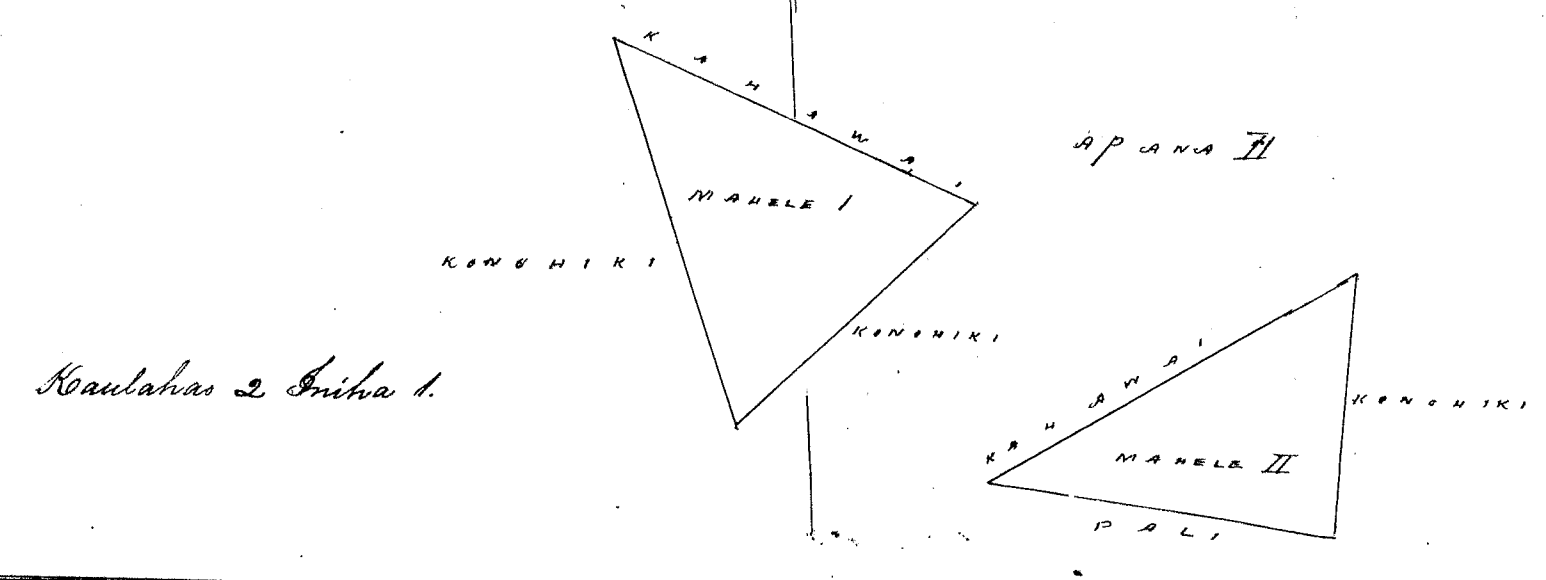

Kaulahas 2 Iuka 1.

W. L. Lee
G. M. Robertson
J. K. Kaulaha
J. H. Smith

Honolulu 27 Oct 1852

Kulu 5516 Kilaue

Hamakuahoa Maui

Apana I. Ili Kalohiki Ahupuaa Kalawa E hoomaka ke ana ma ke kahi Hikitina o keia Heema 22 Komohana 107 Kaulahas ma Kula, Akau 71 Komohana 338 Kaulahas ma ka pali Akau 19 1/2 Hikitina 148 Kaulahas ma ka pali, Heema 64 Hikitina 343 Kaulahas ma Kula, a hiki ma kahi i hoomaka i, a maloko oia anapuni 4 1/10 Eka.

Apana II Ili Kamaria Honopuu. E hoomaka ke ana ma ke kahi Komohana o keia a pili ana me Kapali a me Manoa. Heema 36 Hikitina 377 Kaulahas ma ka Pali, Akau 18 1/2 Hikitina 415 Kaulahas, ma ke Kaawa, Akau 5 Komohana 458 Kaulahas ma ke Nakaikuaana, Heema 4 1/2 Komohana 210 Kaulahas ma ke Pio Akau 4 3/4 Komohana 184 Kaulahas ma ke Pio Heema 59 Komohana 33 Kaulahas, ma ke Manoa, a hiki ma kahi i hoomaka i, a maloko oia anapuni 1 Eka.

John S. Gower
Mea ana aia

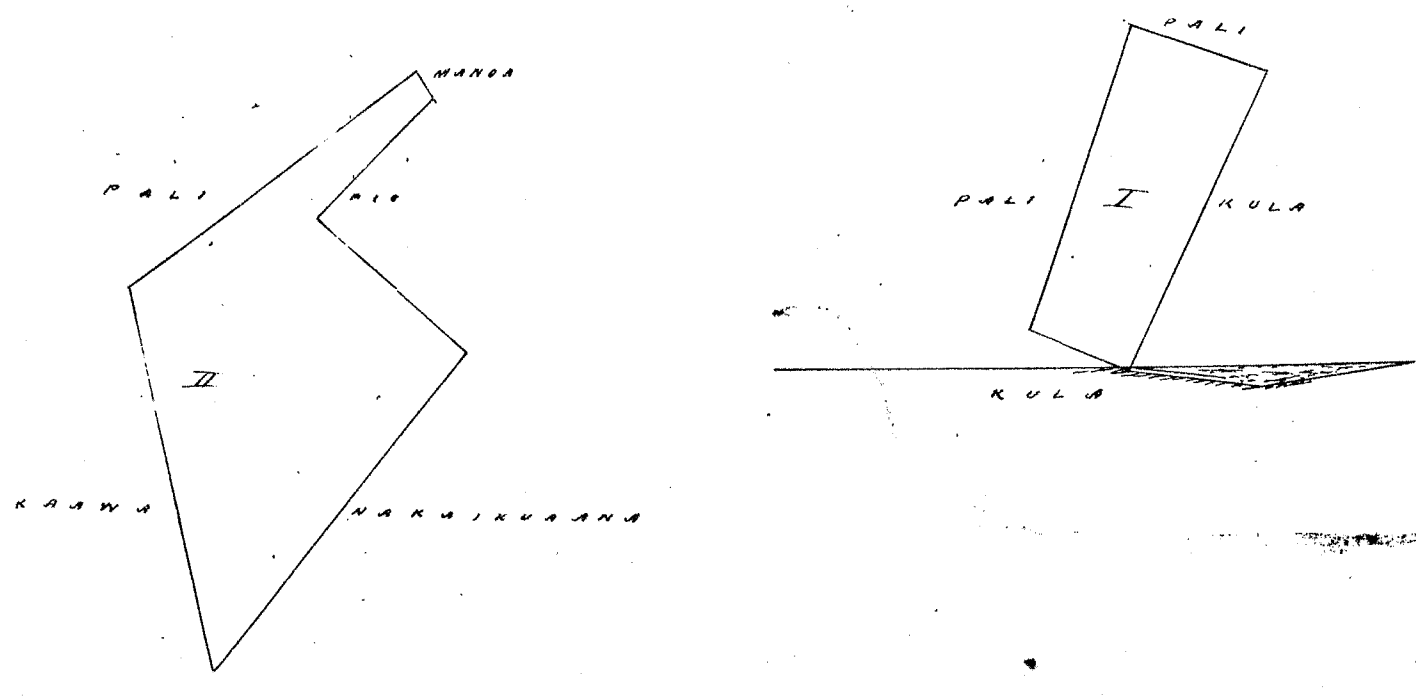

Kaulahas 2 Iuka 1.

Uku Pau Loa # 5
 W. L. Lee
 G. M. Robertson
 J. Kaulahao
 J. H. Smith

Honolulu 27 Oct 1852

Heleu 5491 Kookaia

Hamakua Maui

Apana I. Ili o Kaohi Kuaiaha Komohana. E hoomaka ana ma ke kahi Komohana o keia e pili ana me
 Hoas. Ak. 59 3/4. Hikina 149 Kaulahao ma ke Hoas. Hema 17. Hikina 319 Kaulahao ma ke Pali. Akau
 8 1/2. Komohana 170 Kaulahao ma ke Mahiai Akau 25 1/2. Komohana 57 Kaulahao ma ke Pali. Akau
 12 3/4. Komohana 158 Komohana. Kaulahao ma ke Pali, a hiki ma kahi i hoomaka i a maloko
 via anapuni, 31/100 Eka.

Apana II Aole loa oia,

John S. Gower
 Mea ana aia

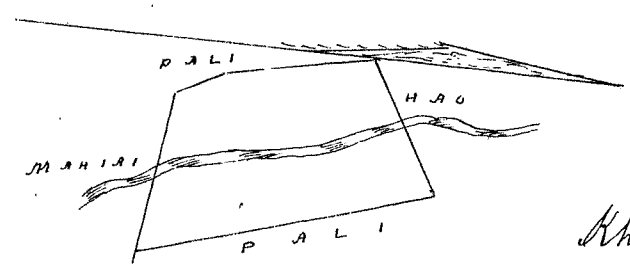

Pl 2 Ser 1.

Uku Pau Loa # 4

W. L. Lee
 G. M. Robertson
 J. Kaulahao
 J. H. Smith

Honolulu 27 Oct 1852

Heleu 3886 Napela

Waieae Maui

Apana I. Ili Kalepulepe. E hoomaka ke ana ma ke kahi Hikina o keia, e pili ana me Kaaamaku,
 a me Maikaaaloa, Hema 58. Komohana 195 Kaulahao, ma ke Maikaaaloa, Akau 34 1/2. Komohana 273
 Kaulahao, ma ke Kalua, Akau 68. Hikina 231 Kaulahao, ma ke Kaawa, Hema 43 1/2. Hikina 88 Kaulahao, ma ke
 Laupohaku, a Kaaamaku, Hema 50. Komohana 207 Kaulahao, ma ke Poalima, Hema 32. Hikina 61 Kaulahao
 ma ke Poalima, Akau 56 1/4. Hikina 184 Kaulahao, ma ke Poalima, Hema 26 Hikina 60 Kaulahao ma
 ke Kaaamaku, a hiki ma kahi i hoomaka i, a maloko via anapuni, 41/100 Eka,

Apana II Ili Kapoho. E hoomaka ke ana ma ke kahi Komohana Hema o keia, Akau 75 1/2. Hikina
 253 Kaulahao, ma Kula, Akau 9. Komohana 136 Kaulahao ma Kula, Hema 74. Komohana 254 Kaulahao, ma
 Kula, Hema 8 3/4. Hikina 130 Kaulahao ma Kula, Paapohaku, a hiki ma kahi i hoomaka i, a maloko via
 anapuni, 34/100 Eka,

Apana III Ili Kapoho E hoomaka ke ana ma ke kahi Hema o keia, Akau 59. Komohana 108 Kaulahao,
 ma Kula, Akau 21. Hikina 371 Kaulahao ma Paapohaku, Hema 56 Hikina 204 Kaulahao, ma ke Kahihihula
 Hema 36. Komohana 354 Kaulahao ma ke Komohiki, a hiki ma kahi i hoomaka i, a maloko via anapuni
 55/100 Eka,

John S. Gower
 Mea ana aia

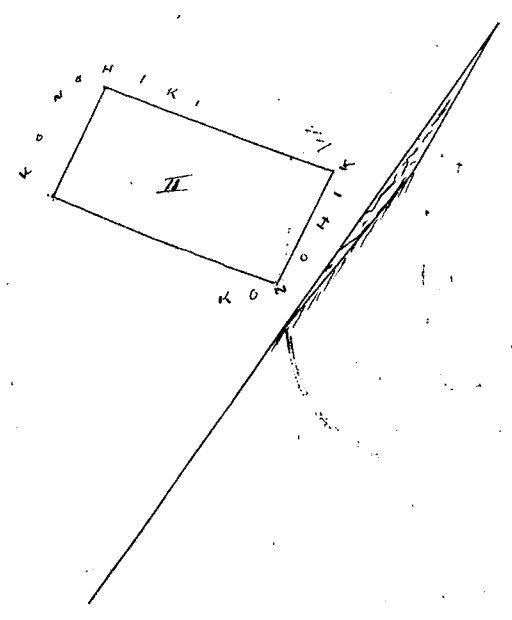
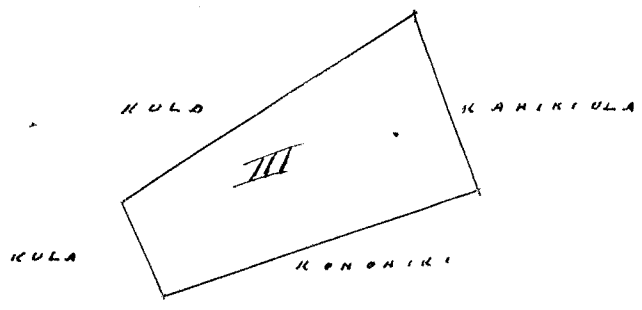

2 Kaul. 1 Iriha



Uku Pau Loa p 5

W. L. Lee
G. M. Robertson

J. Kekaulaha

J. H. Smith

Honolulu 27 Oct 1852

Heleu 5516^B Maua

Hamakua Maui

Apana I. Ili Kuahanahana, Chomaka ke ana ma ke kahi Hikina Aema o keia, Aema 6 1/4 Komohana 170 Kaulahas, ma ka Anapuni, Akau 11 Komohana 342 Kaulahas, ma ka pali, Aema 7 3/4 Hikina 136 Kaulahas, ma ke Anapuni, Aema 21 Hikina 238 Kaulahas, ma ka Auwai, a hiki ma kahi i hoomaka i a maloko oia anapuni, 41/100 Eka.

Apana II Ili Kuahanahana, Chomaka ke ana ma ke kahi Akau o keia, Aema 49 1/2 Komohana 123 Kaulahas ma Kula, Aema 35, Hikina 605 Kaulahas ma ka Pali, Akau 57 1/2 Hikina 90 Kaulahas, ma ke Manoa, Akau 32, Komohana 630 Kaulahas, ma ke Kula malalo, a hiki ma kahi i hoomaka i, a maloko oia anapuni 65/100 Eka.

Wailuku Aug 13, 1852

John S. Gower,
Aea ana aina.

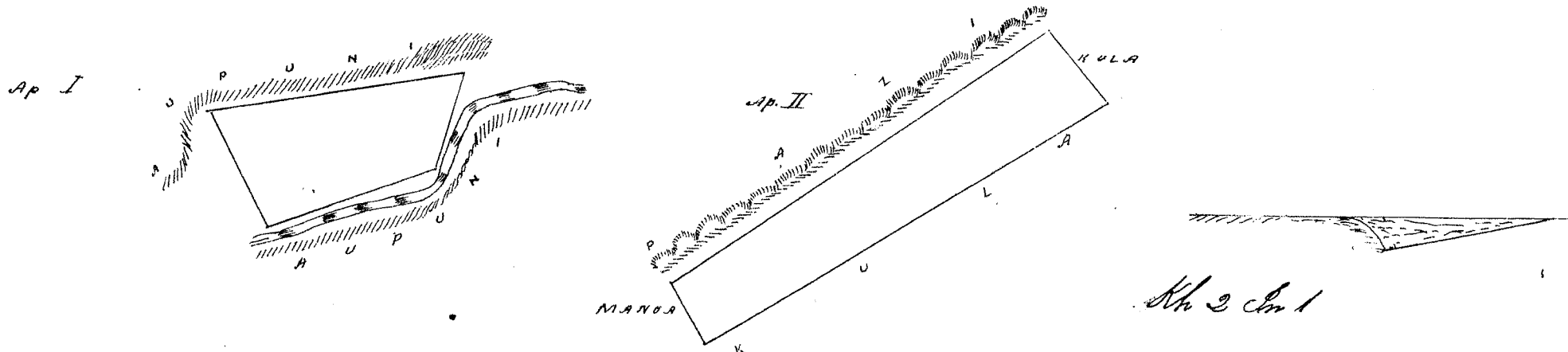

Uku Pau Loa p 5

W. L. Lee

G. M. Robertson

J. Kekaulaha

J. H. Smith

Honolulu 27 Oct 1852

Heleu 5516^C Kaio

Hamakua Maui

Mahle I Ili Halenoni, Hobawa, Chomaka ke ana ma ke kahi Aema o keia Akau 60, Hikina 110 Kaulahas, ma ke Nahelhele, Akau 16 3/4 Komohana 277 Kaulahas, ma Kula, Akau 49 1/4 Komohana 132 Kaulahas, ma ke Awa, Aema 11 1/4, Hikina 413 Kaulahas, ma ka pali, a hiki ma kahi i hoomaka i, a maloko oia anapuni 31/100 Eka.

Mahle II Ili Halenoni, Chomaka ke ana ma ke kahi Hikina o keia, Aema 39 1/2 Komohana 105 Kaulahas, ma Kula, Akau, 39 Komohana 330 Kaulahas ma ka pali, Akau 48 1/4 Hikina 74 Kaulahas, ma Kula, Aema 45 1/4, Hikina 312 Kaulahas ma Kula, a hiki ma kahi i hoomaka i, a maloko oia anapuni, 28/100 Eka.

Wailuku, Aug 13, 1852

John S. Gower,
Aea ana aina

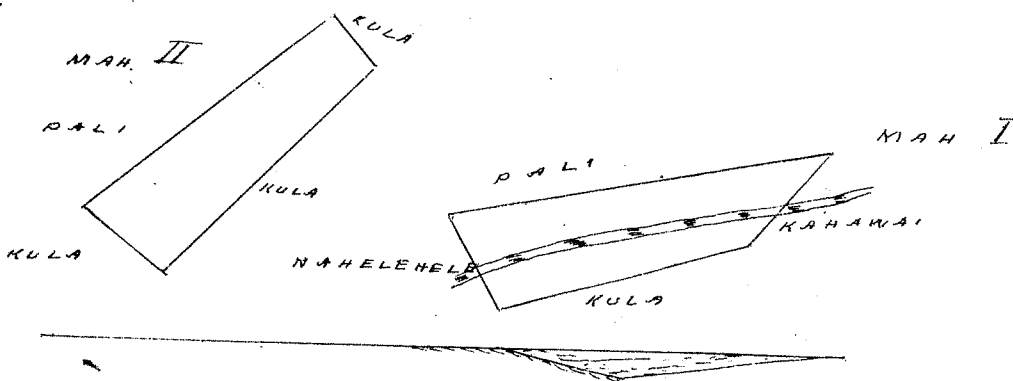

Sh. 2, In 1.

Uku Pau Loa / 4
W. L. Lee
G. M. Robertson
J. Kaulahas
J. H. Smith

Honolulu 27 Oct 1852.

Uku 5516 Naopu (via Opu) /

Kamakuaka Maui

Apana I. Iki Kauhamao, Ahupuaa Hobawa, Choomaka ke ana ma ke kiki Komohana
Akaui, keia, Hema 60 1/2, Hikina 532 Kaulahas, ma Kula, Hema 26, Komohana 89 Kaulahas ma
ko Manoa, Hema 46, Hikina 234 Kaulahas, ma ko Manoa, Hema 65 1/4, Hikina 224 Kaulahas
ma ko Manoa, Hema 10, Hikina 173 Kaulahas ma Kula, Hema, 53 1/2, Komohana 269 Kaulahas,
ma Kula, Akaui 37 1/2, Komohana 1137 Kaulahas ma Kula, Akaui 11, Hikina 97 Kaulahas ma Kaulahas
a hiki ma kahi i hoomaka'i, a maloko oia anapuni, 2 53/100 Eka.

Apana II Iki Halimaumau, Hobawa, Choomaka ke ana ma ke kiki Akaui, keia
Hema 46 1/2 Komohana 290 Kaulahas ma ka pali, Akaui 86, Komohana 291 Kaulahas ma ka pali
Hema 4, Hikina 880 Kaulahas ma ka pali, Akaui 62, Hikina 413 Kaulahas ma ko Manoa,
Akaui 34, Hikina 645 Kaulahas ma Kula Pali, Akaui 41, Komohana 437 Kaulahas ma hiki ma
Kula aas, a hiki ma kahi i hoomaka'i, a maloko oia anapuni 485/100 Eka,

Apana III & IV Ua maha ole oia.

Wailuku, Aug. 24, 1852

John S. Lower
Ma ana aiva

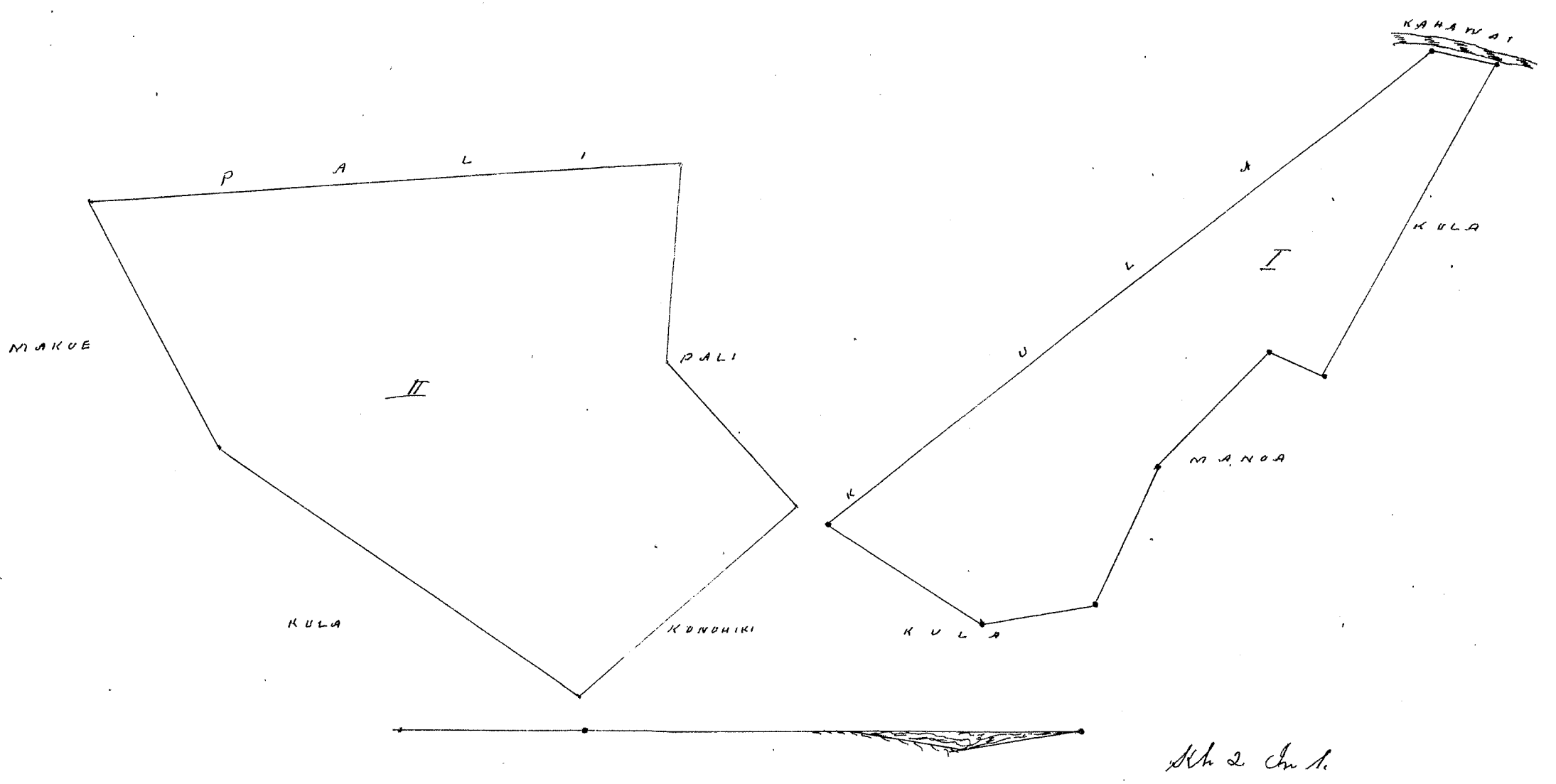

Uku Pau Loa / 8
W. L. Lee
G. M. Robertson
J. Kaulahas
J. H. Smith

Honolulu 27 Oct 1852.

Apana I. Ii Opiki Kuaaha Komohana Kalo Chomaka ke ana ma ke kiki Akau o keia maluna. ka pohaku, Hema $33\frac{1}{2}$ Hikiina 192 Kaulahas, ma ka Pali, Hema $27\frac{1}{2}$ Komohana 223 Kaulahas, ma ka Pali, Akau $35\frac{3}{4}$ Komohana 204 Kaulahas, ma ke Kikua, Akau 31 Hikiina 223 Kaulahas, ma ka Pali, a hiki ma kela arao, ma kahi i hoomaka'i, a maloko oia anapuni $4\frac{2}{100}$ Eka.

Apana II Ii Opiki Kula. Chomaka ke ana ma ke kiki Akau o keia, maluna ke pali arao Hikiina, Hema 62, Komohana, 13.00 Kaulahas, ma ke Komohiki, Hema 39° Hikiina 647 Kaulahas, ma ka Pali Komohiki, Akau $43\frac{1}{2}$ Hikiina 13.32 Kaulahas ma ke Komohiki, Akau $38\frac{1}{2}$ Komohana 247 Kaulahas, ma ka pali, maluna, a hiki ma kahi i hoomaka'i a maloko oia anapuni, $5.72\frac{1}{100}$ Eka.

Wailuku, Aug. 25, 1852

John S. Gower
Mea ana aina

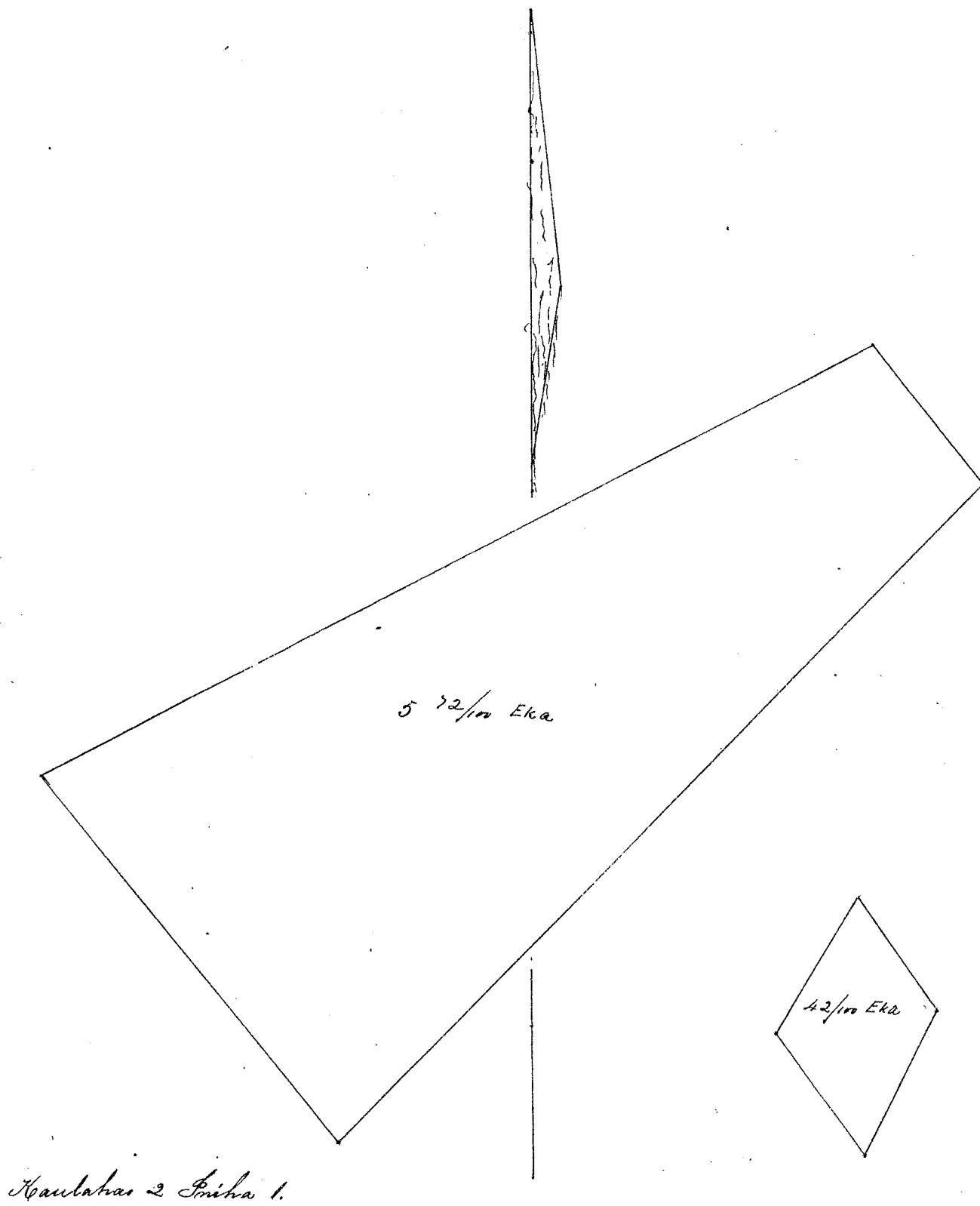

Kaulahas 2 Iiika 1.

Wm. T. Lee

M. L. Lee
G. W. Robertson
J. A. Kaulahas
J. H. Smith

Honolulu 27 October 1852

Apana I. Ili Kapalawa, Chomaka ke ana ma ke kiki Hikiina o keia, i pili ana me ke kiki Hikiina o Keohula. Akau $5\frac{3}{4}$ Komohana 258 Kaulahas ma ke Keohula. Hema $81\frac{3}{4}$ Komohana 74 Kaulahas ma ke Poalima. Akau 5 Komohana 84 Kaulahas ma ke Poalima. Hema $84\frac{3}{4}$ Komohana 120 Kaulahas ma ke Poalima. Hema 3 Komohana 165 Kaulahas ma ke Poalima. Hema $82\frac{1}{4}$ Hikiina 38 Kaulahas ma ke Poalima. Hema 4 Komohana 95 Kaulahas ma ke Poalima. Hema $89\frac{1}{2}$ Komohana 129 Kaulahas ma ke Poalima. Hema $1\frac{1}{2}$ Komohana 114 Kaulahas ma ke Poalima. Hema $84\frac{1}{2}$ Komohana 74 Kaulahas ma ke Poalima. Akau $6\frac{1}{2}$ Komohana 293 Kaulahas ma ke Poalima. Akau $74\frac{1}{2}$ Komohana 52 Kaulahas ma ke Poalima. Akau 2 Hikiina 87 Kaulahas ma ke Poalima. Hema 89 Komohana 53 Kaulahas ma ke Konoehiki. Hema $9\frac{1}{2}$ Komohana 332 Kaulahas ma ke Konoehiki. Hema 57 Hikiina 215 Kaulahas ma ke Konoehiki. Akau $73\frac{3}{4}$ Hikiina 132 Kaulahas ma ke Konoehiki. Akau 76 Hikiina 304 Kaulahas ma ke Konoehiki; a hiki ana kahi i hoomaka i, a maloko oia anapuni, $1\frac{3}{10}$ Eka,

Apana 2. Ili Ohia, Chomaka ke ana ma ke kiki Hikiina o keia, i pili ana me ke kiki Hikiina Akau o Kalomi. Akau $21\frac{1}{2}$ Komohana 374 Kaulahas ma ke Hula. Akau 58 Komohana 82 Kaulahas ma ke Apapau. Hema 25 Komohana 462 Kaulahas ma ke Konoehiki. Hema $43\frac{3}{4}$ Hikiina 172 Kaulahas ma ke Kalomi. Akau 35 Hikiina 135 Kaulahas ma ke Kalomi. Hema 55 Hikiina 64 Kaulahas ma ke Kalomi. Akau $62\frac{1}{2}$ Hikiina 174 Kaulahas ma ke Kalomi; a hiki ana kahi i hoomaka i a maloko oia anapuni, $1\frac{9}{10}$ Eka,

Apana III Ili Healawa, Chomaka ke ana ma ke kiki Hikiina o keia, i pili ana me ke kiki Hikiina o Kuali, Hema $53\frac{3}{4}$ Komohana 345 Kaulahas ma Kahawai. Akau 34 Komohana 120 Kaulahas ma ke Hane. Akau $39\frac{1}{2}$ Hikiina 284 Kaulahas ma ke Hane. Hema $67\frac{1}{4}$ Hikiina 85 Kaulahas ma ke Kuali. Hema 48 Hikiina 125 Kaulahas ma ke Kuali; a hiki ana kahi i hoomaka i, a maloko oia anapuni, $5\frac{1}{10}$ Eka,

Apana IIII Ili Kahakupia, Chomaka ke ana ma ke kiki Hikiina o keia, i pili ana me ke Kahawai. Hema 60 Komohana 202 Kaulahas ma Kahawai. Akau $85\frac{1}{4}$ Komohana 478 Kaulahas ma Kahawai. Akau 6 Hikiina 150 Kaulahas ma ke Poalima. Akau 85 Komohana 30 Kaulahas ma ke Poalima. Hema 6 Komohana 129 Kaulahas ma ke Poalima. Akau 60 Komohana 433 Kaulahas ma Kahawai. Akau 70 Hikiina 214 Kaulahas ma ke Pali. Hema 72 Hikiina 465 Kaulahas ma ke Pali. Akau 88 Hikiina 153 Kaulahas ma ke Pali. Akau $83\frac{1}{2}$ Hikiina 253 Kaulahas ma ke Pali. Hema 5 Hikiina 107 Kaulahas ma ke Pali; a hiki ana kahi i hoomaka i, a maloko oia anapuni, $2\frac{7}{10}$ Eka,

Kailuku Aug. 20, 1852

John S. Lewis
Mea ana aina

1.30
1.9
5
2.7
4.97

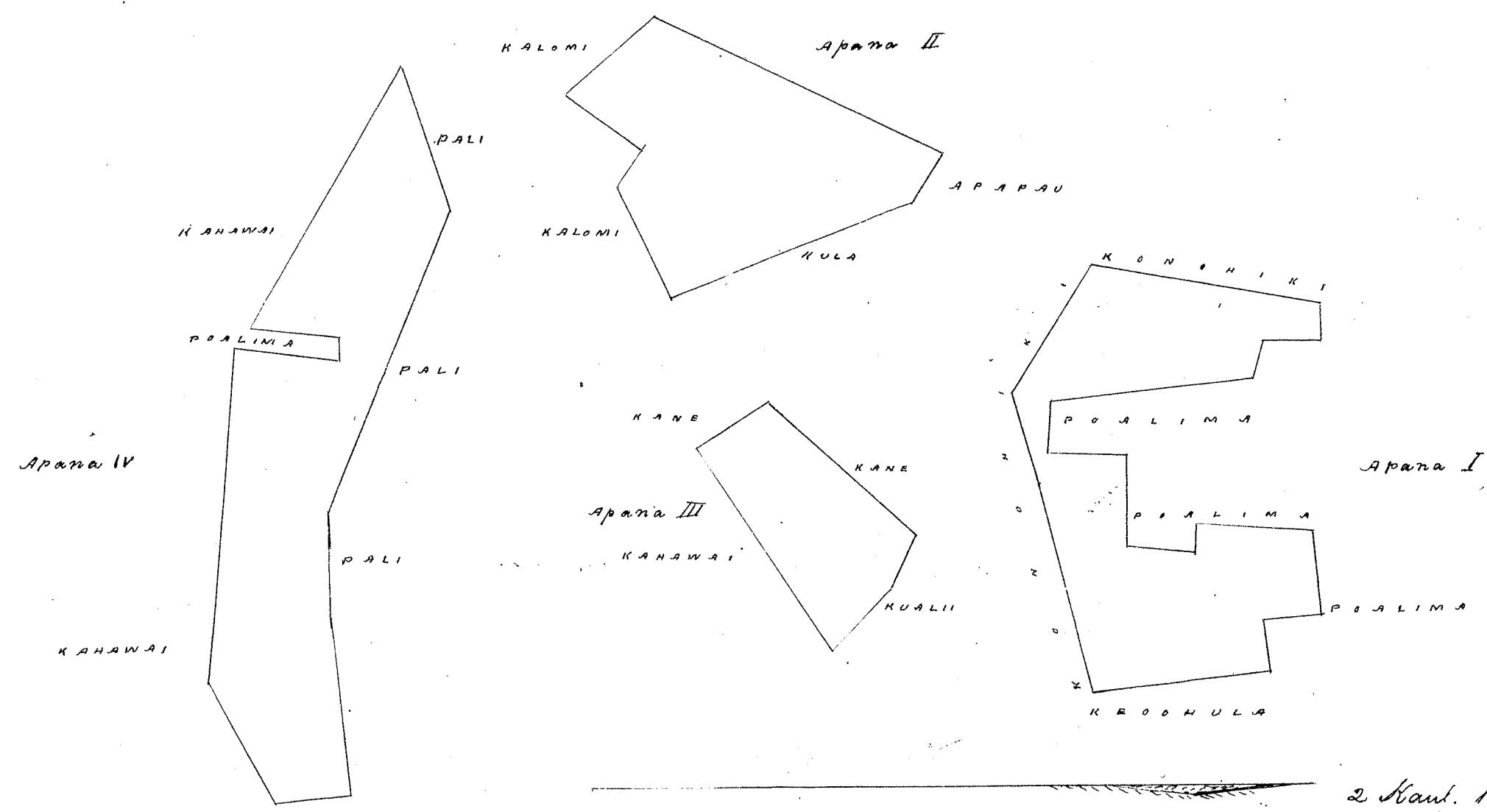

2 Kaul. 1 Inch

Uku Pau Loa # 7

W. L. Lee
G. W. Robertson
J. Kekaulahas
J. H. Smith

Honolulu October 27, 1852.

Keleu 2468 Keleu

Waiehu Maui

Apana I. Ili Ohianui, E hoomaka ke ana ana ke kahi Komohana Akau o keia, e pili ana me ke kahi Kema o Katinui, Hema 29 1/4; Komohana 3 1/4 Kaulahas ma Kula, Hema 87 1/2; Hikinua 359 Kaulahas ma ka Pali Akau 1; Hikinua 46 Kaulahas ma ka Poalima, Hema 67; Hikinua 127 Kaulahas ma ka Poalima, Hema 16, Komohana 47 Kaulahas ma ka Poalima, Hema 68 1/2; Hikinua 419 Kaulahas ma ka Pali, Akau 16 1/4; Hikinua 439 Kaulahas ma ke Kalo, Akau 85 3/4; Komohana 103 Kaulahas ma Kahawai, Akau 51; Komohana 176 Kaulahas ma Kahawai, Hema 33 1/2; Komohana 79 Kaulahas ma Kahawai, Hema 70; Hikinua 121 Kaulahas ma ka Poalima, Hema 11 3/4; Hikinua 105 Kaulahas ma ka Poalima, Hema 10; Komohana 74 Kaulahas ma ka Poalima, Akau 67 1/2; Komohana 455 Kaulahas ma ka Poalima, a hiki ma kahi i hoomaka i; a ma loko oia awapuni, 2 49/100 Eka.

Apana II Ili Akaka, E hoomaka ke ana ana ke kahi Komohana Hema o keia, e pili ana me ka Pali, Akau 22 1/4 Komohana 267 Kaulahas ma ke Komohiki, Akau 72 1/2; Hikinua 197 Kaulahas ma Kahawai, Hema 6 1/2; Hikinua 295 Kaulahas ma ke Kaia Hema 84 1/4; Komohana 125 Kaulahas ma ka Auwai, a hiki ma kahi i hoomaka i; a ma loko oia awapuni, 2 5/100 Eka.

Hailuku, Aug 12, 1852

John S. Gower
Ma ana ana

2,49
45
294

Apana I,

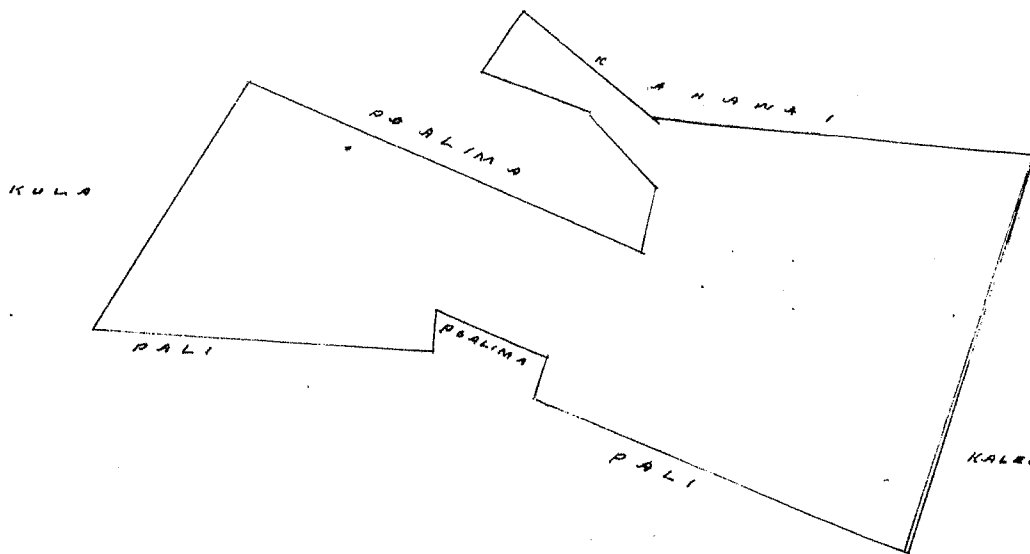

Apana II

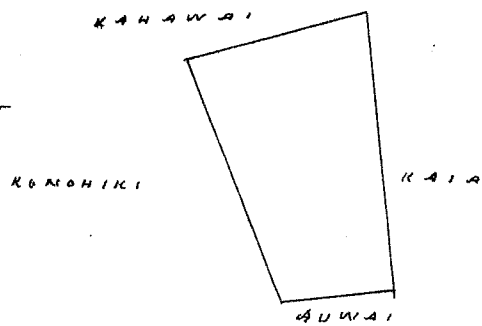

2 Hk 1 In.

Uku Pau Loa # 6

W. L. Lee
G. W. Robertson
J. Kekaulahas
J. H. Smith

Honolulu, 27, Oct, 1852.

Apāna I. Ili Kalamipali. Kūi aka Hīkina. E hōmaka ke ana ma ke kīhi Komohana Aka. Keia
 e pili ana me Kēkamaka. Aka 67. Hīkina 62 Kaulahas. ma Kēkamaka, Aka 74 1/2. Hīkina 387 Kaul
 ma ke Pali. Hema 8 1/2. Hīkina 134 Kaulahas ma ke pali. Hema 9 3/4. Hīkina 123 Kaulahas. ma ke pali
 Hema 34 Hīkina 442 Kaulahas. ma ke pali. Aka 15 1/2. Komohana 283 Kaulahas ma ke pali. Aka 5.
 Komohana 429 Kaulahas ma ke pali. Hema 81 Komohana 79 Kaulahas. ma ke pali. Hema 79 1/2
 Komohana 61 Kaulahas ma ke pali. Hema 62 1/2. Komohana 218 Kaulahas ma ke pali. Aka 27.
 Komohana 152 Kaulahas ma ke pali, a hiki ma kahi i hōmaka i, a maloko ia anapuni
 1. 12/100 Eka.

Apāna. III Ili Paiki Ahupuaa. Kāupakutua. Komohana. E hōmaka ke ana ma
 ke kīhi Hīkina Hema. Keia, Aka 11 Komohana 241 Kaulahas ma ke pali. Aka 3 3/4. Hīk
 ina 313 Kaulahas ma ke pali Hema 74 3/4. Komohana 347 Kaulahas ma ke pali. Hema 26 1/4
 Komohana 520. Kaulahas. ma ke pali. Aka 87 1/2. Hīkina 546 Kaulahas ma ke kīhi a hiki
 i kahi i hōmaka i, a maloko ia anapuni. 2. 14/100 Eka.

Paalima. E hōmaka ke ana ma ke kīhi Hema. Keia Mai ke pahu hope. Keia Kuluana. Aka
 59 1/2. Hīkina 234 Kaulahas. Aka 37. Komohana 169 Kaulahas. Aka 37 1/4. Hīkina 388 Kaulahas
 Hema 37 Hīkina 169 Kaulahas. Hema 37 1/4. Komohana 38 Kaulahas, a hiki ma kahi i hōmaka i
 a maloko ia anapuni. 6/100 Eka.

Wailuku Sept 6. 1852.

John S. Low
Ma ana ana

1.12
2.14
3.26

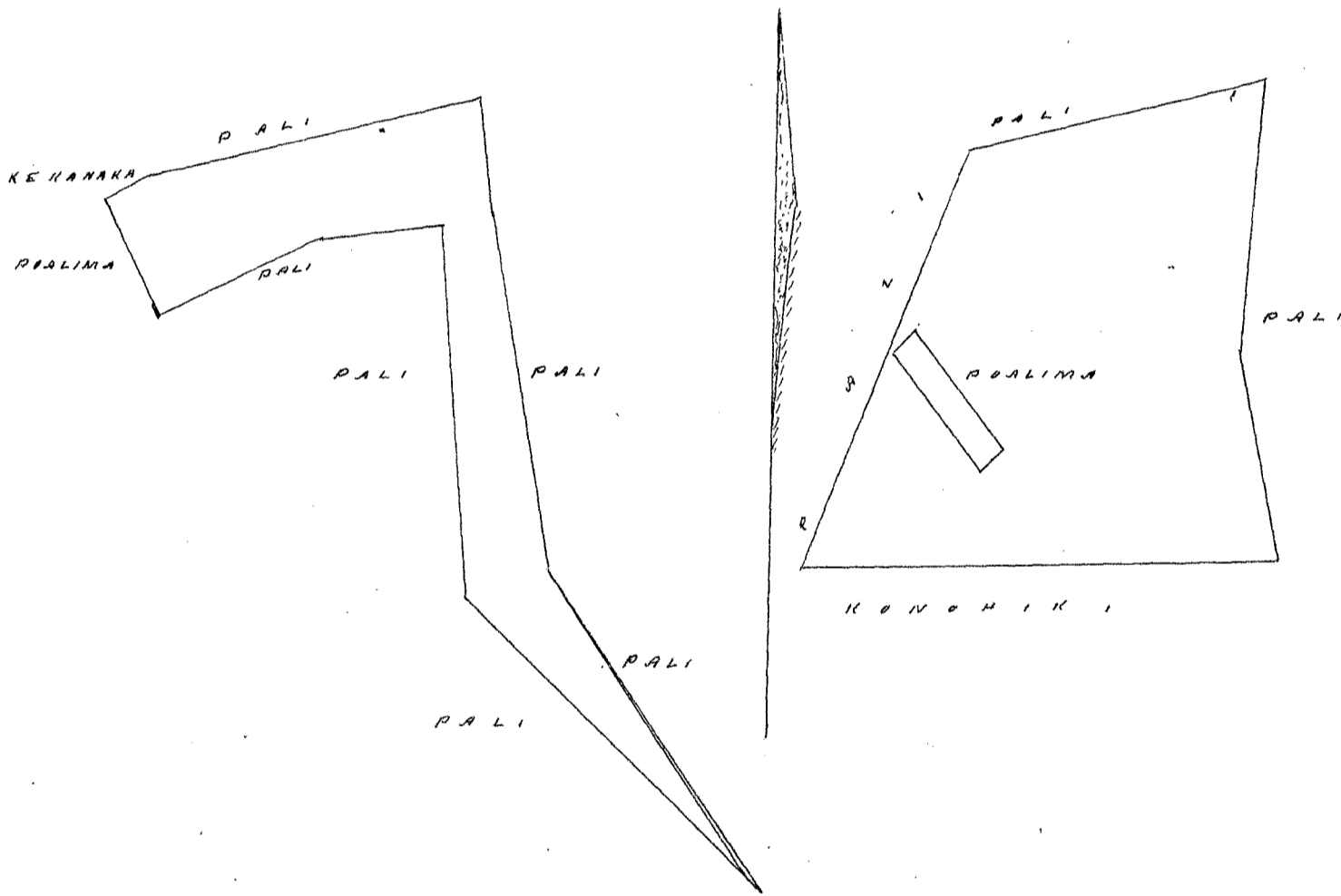

- Apāna II Aole loa ia
- Apāna III Iloke Kānehoalani
- Apāna V Ua māhi ole oia

Ulu Pau Loa 7
 W. L. Lee
 G. M. Robertson
 J. K. Kaulahao
 S. H. Smith

Honolulu 27. Oct. 1852

Apana I Iki Kahaloa, Kūiwa Komohana. E hoomaka ke ana ma ke kīhi Komohana, keia e pili ana ma ke alanui, Akau 87 Hikiina 167 Kaulahao ma ke alanui, Hema 15° Hikiina 389 Kaulahao ma ke Kahawai, Hema 51/4° Hikiina 250 Kaulahao ma ke pali, Akau 84/4° Hikiina 271 Kaulahao ma ke pali, Hema 48° Hikiina 90 Kaulahao ma Kahawai, Hema 77/2 Komohana, 355 Kaulahao ma ke Poalima, Hema 16° Komohana 35 Kaulahao ma ke Poalima Akau 77/2 Hikiina 355 Kaulahao ma ke Poalima, Hema 16 Komohana 268 Kaulahao ma Kahawai, Akau 54 Komohana 145 Kaulahao ma ke Pali, Akau 72° Komohana 336 Kaulahao ma ke Pali, Akau 19/4° Komohana 290 Kaulahao ma ke Pali, Akau 16/2° Komohana 626 Kaulahao ma ke Pali a hiki ma kahi i hoomaka i a maloke oia anapuni, 191/100 Eka,

Apana II Iki Kahaloa, Kūiwa E hoomaka ana ma ke kīhi Komohana Akau keia, e pili ana ma ke Alanui, Hema 75/2° Hikiina 444 Kaulahao ma ke pali maluma, Hema 15 Hikiina 708 Kaulahao ma ke pali maluma, Akau 81° Komohana 677 Kaulahao, a hiki malalo, Akau 25/2° Komohana 284 Kaulahao, ma ke pali malalo, Akau 45° Hikiina 364 Kaulahao a hiki maluma, a hiki ma kahi i hoomaka i, a maloke oia anapuni 458/100 Eka,

Apana III Iki Kapiki Kūiwa Komohana. E hoomaka ke ana ma ke kīhi Kūiwa keia, Akau 52, Komohana 30 Kaulahao, ma ke Kēkēhuna, Akau 51 Hikiina 150 Kaulahao ma ke Pali, Hema 52 Hikiina 30 Kaulahao ma ke Mahiai, Hema 51° Komohana 150 Kaulahao ma ke Mahiai a hiki ma kahi i hoomaka i a maloke oia anapuni, 4/100 Eka,

Apana 3. Iki. Kahawai.
Wailuku, Aug 25, 1852.

John S. Tower.
Ma ana aina.

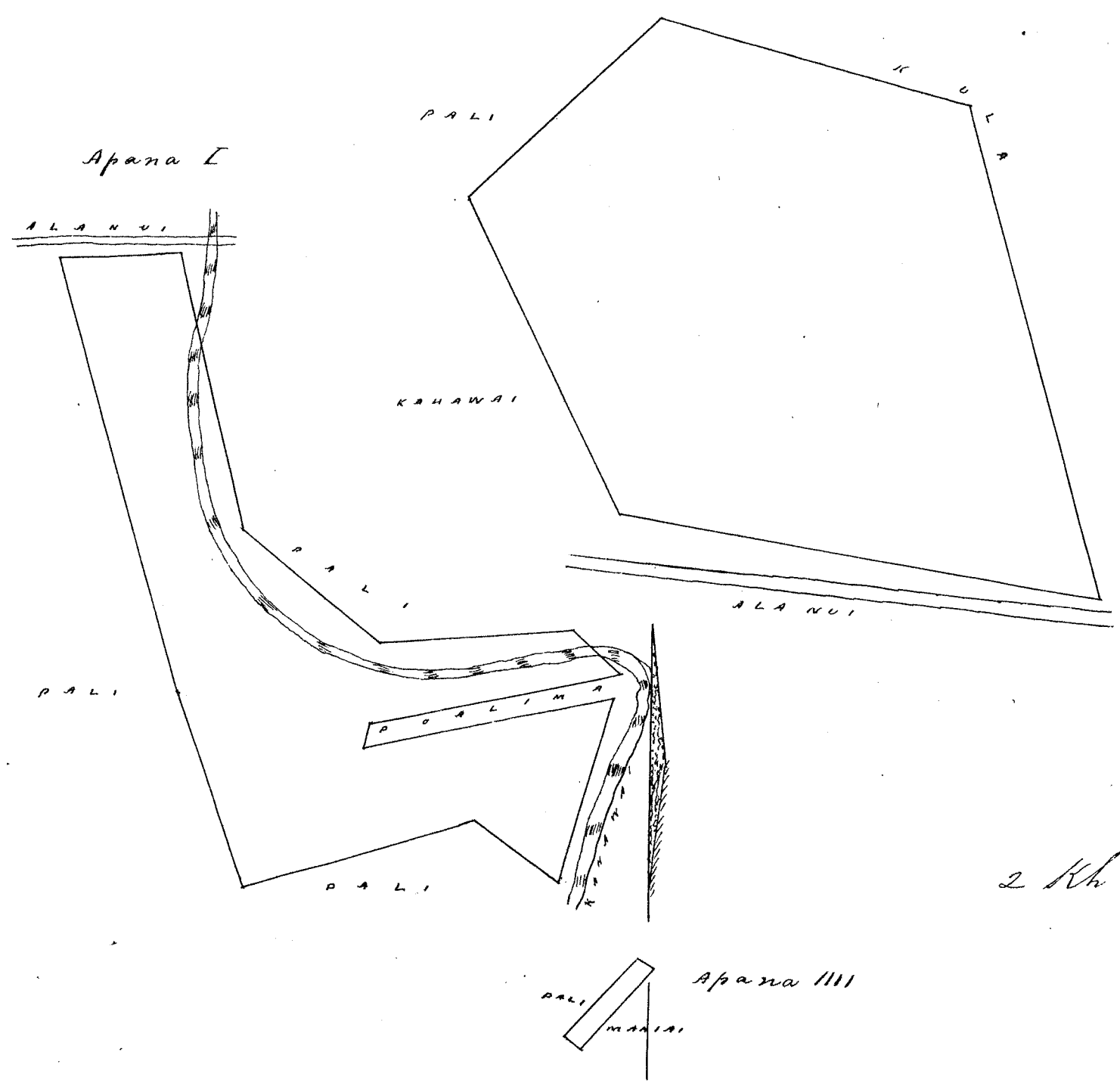

W. L. Lee
G. M. Robertson
J. Kaulahao
J. H. Smith

Honolulu 27 Oct 1852
Hulu 3213 Lohu

Waiau Maui

Apana I. Iki Kaulahao. E hoomaka ke aua ma ke kiki Hikiina hema o keia, Niki Akau o Kapulu
 Akau 11. Komohana 52 Kaulahao ma Komohiki, Hema 76 1/4. Komohana 146 Kaulahao ma Komohiki, Hema 24.
 Hikiina 63 Kaulahao ma Poalima, Hema 56. Komohana 57 Kaulahao ma Poalima, Akau 29 1/2, Komohana
 70 Kaulahao ma ka Poalima, Hema 56 1/4. Komohana 154 Kaulahao ma ke Kepaa, Hema 76 1/4
 Komohana 376 Kaulahao ma ke Kepaa, Akau 24. Hikiina 52 Kaulahao ma ke Kepaa, Akau 28.
 Komohana 35 Kaulahao ma ke Kepaa, Akau 83. Komohana 119 Kaulahao ma ka Poalima Akau 14 3/4,
 Komohana 171 Kaulahao ma ka Poalima, Akau 68. Hikiina 709 Kaulahao ma ke Kepaa, Akau 23 1/2
 Komohana 296 Kaulahao ma ke Kula, Hema 83 1/2. Kom. 472 Kaulahao Pa pohaku, Hema 73 1/4
 Komohana 268 Kaulahao ma Pa pohaku, Hema 23. Hikiina 113 Kaulahao ma Poalima Hema 57 1/2
 Komohana 135 Kaulahao ma Poalima Akau 22 1/4 Kom. 161 Kaulahao ma Poalima, Hema 77
 Komohana 177 Kaulahao ma Komohiki, Hema 17 Hikiina 378 Kaulahao ma ke Kula, Hema 9 1/2
 Hikiina 263. Kaulahao ma ka Poalima Akau 78 1/4 Kom. 69 Kaulahao ma ka Poalima Hema 12
 Komohana 186 Kaulahao ma ke Komohiki, Akau 86 1/2. Hikiina 91 Kaulahao ma ka Poalima, Akau
 3 1/4. Hikiina 78. Kaulahao ma ka auwai Hema 86 3/4 Hikiina 100 Kaulahao ma Auwai Hema 55.
 Hikiina 131 Kaulahao ma ka auwai Akau 64 1/2. Hikiina 246 Kaulahao ma Kapulu, Ak. 74
 Hikiina 74 Kaulahao ma ke Kapulu, Akau 67 1/2. Hikiina 718 Kaulahao ma ke Kapulu, a
 hiki ma kahi i hoomaka i, a maloko ia anapuni, 6 36/100 Eka.

Apana II Ua haalele ia
Waiau, Aug. 12, 1852.

John S. Tower.
(Ma ana aina)

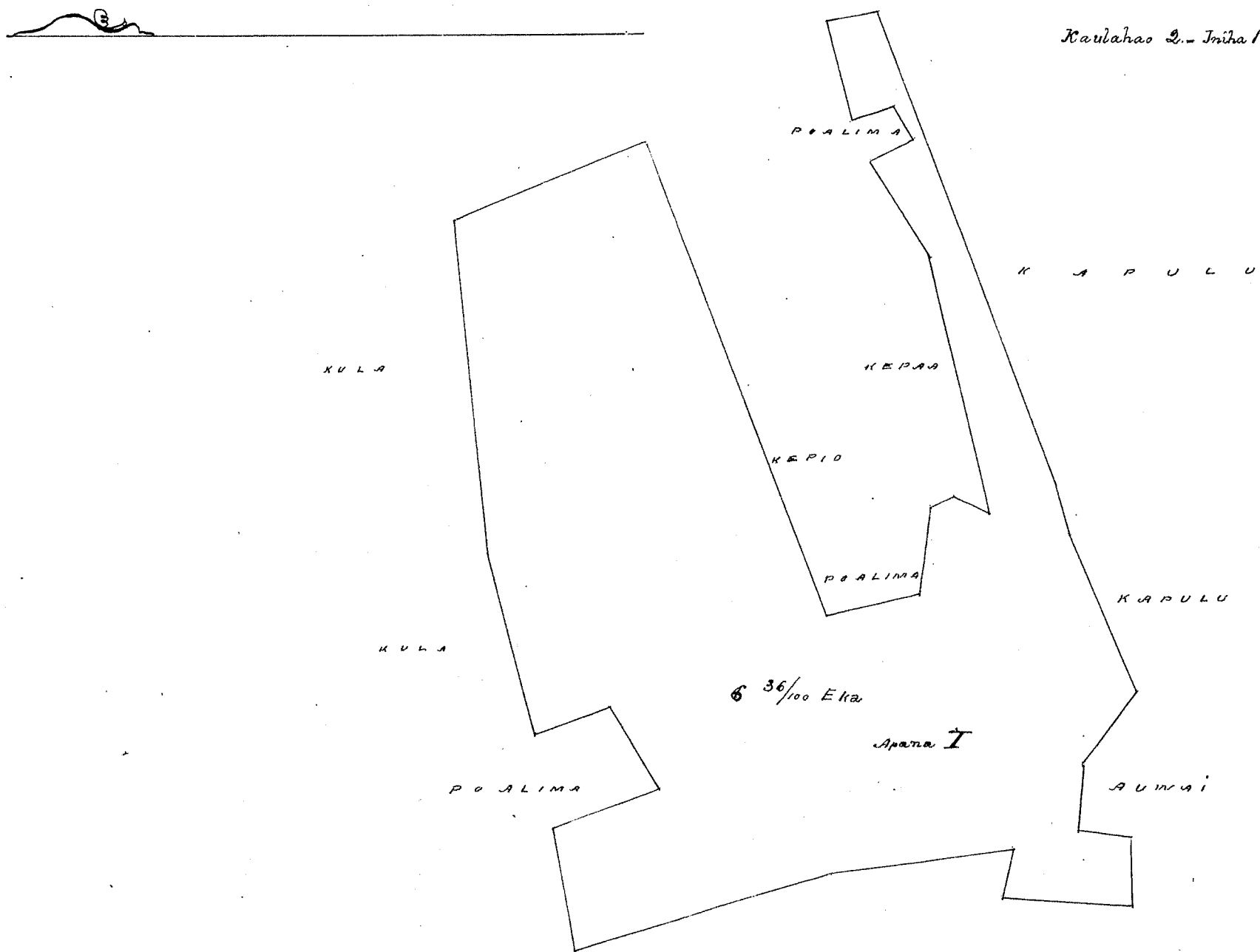

Uku Pau Loa #8
W. L. Lee
G. M. Robertson
J. Kekaulaha
J. H. Smith

Honolulu 27 Oct 1852

Hulu 4432 Kahikiula

Waiau Maui

Apana I. Ili Paulani. Chomaka ke ana ma ke kiki hema o Ahihewa, Hema 77 1/2°
Komohana 191 Kaulahas ma ka auwai; Akau 12 1/2° Komohana 49 Kaulahas ma ka Poalima,
Hema 81 1/2° Komohana 104 Kaulahas ma ka Poalima, Hema 6 1/4° Hikina 46 Kaulahas ma ka Poalima
Hema 83 1/2° Komohana 327 Kaulahas ma ka Auwai; Akau 4 1/2° Komoh. 45 Kaulahas ma ka Poalima
Hema 82 1/2° Komohana 85 Kaulahas ma ka Poalima Hema 10 1/4° Hikina 37 Kaulahas ma ka Poalima,
Hema 85 3/4° Komohana 86 Kaulahas ma ka auwai; Akau 1 Komohana 40 Kaulahas ma ka Poalima
Hema 86 3/4° Komohana 86 Kaulahas ma ka Poalima, Hema 6° Hikina 37 Kaulahas ma ka Poalima
Hema 86 1/2° Komohana 265 Kaulahas ma ka Auwai; Akau 6 1/2° Komohana 68 Kaulahas ma ka Kahinu
Akau 79 1/2° Hikina 10.12 Kaulahas ma ka Pali; Hema 81° Hikina 165 Kaulahas ma ka Pali;
Hema 22 1/2° Hikina 91 Kaulahas ma ke Ahihewa, a hiki ma kahi i hoomaka'i a maloko ia
anapuni 13 1/2/100 Eka.

Apana II Aole nona.

Apana III Ili Kapoho. Chomaka ke ana ma ke kiki Komohana o Napela.
Hema 56° Hikina 204 Kaulahas ma ke Napela, Hema 56° Akau 28° Hikina 218 Kaulahas ma
Komohiki; Akau 77° Komohana 226 Kaulahas ma Kula; Hema 22° Komohana 140 Kaulahas
ma ke Paapohaku, a hiki ma kahi i hoomaka'i a maloko ia anapuni; 38/100 Eka,

Wailuku July 7, 1852

John S. Gows.
Ma ana aina

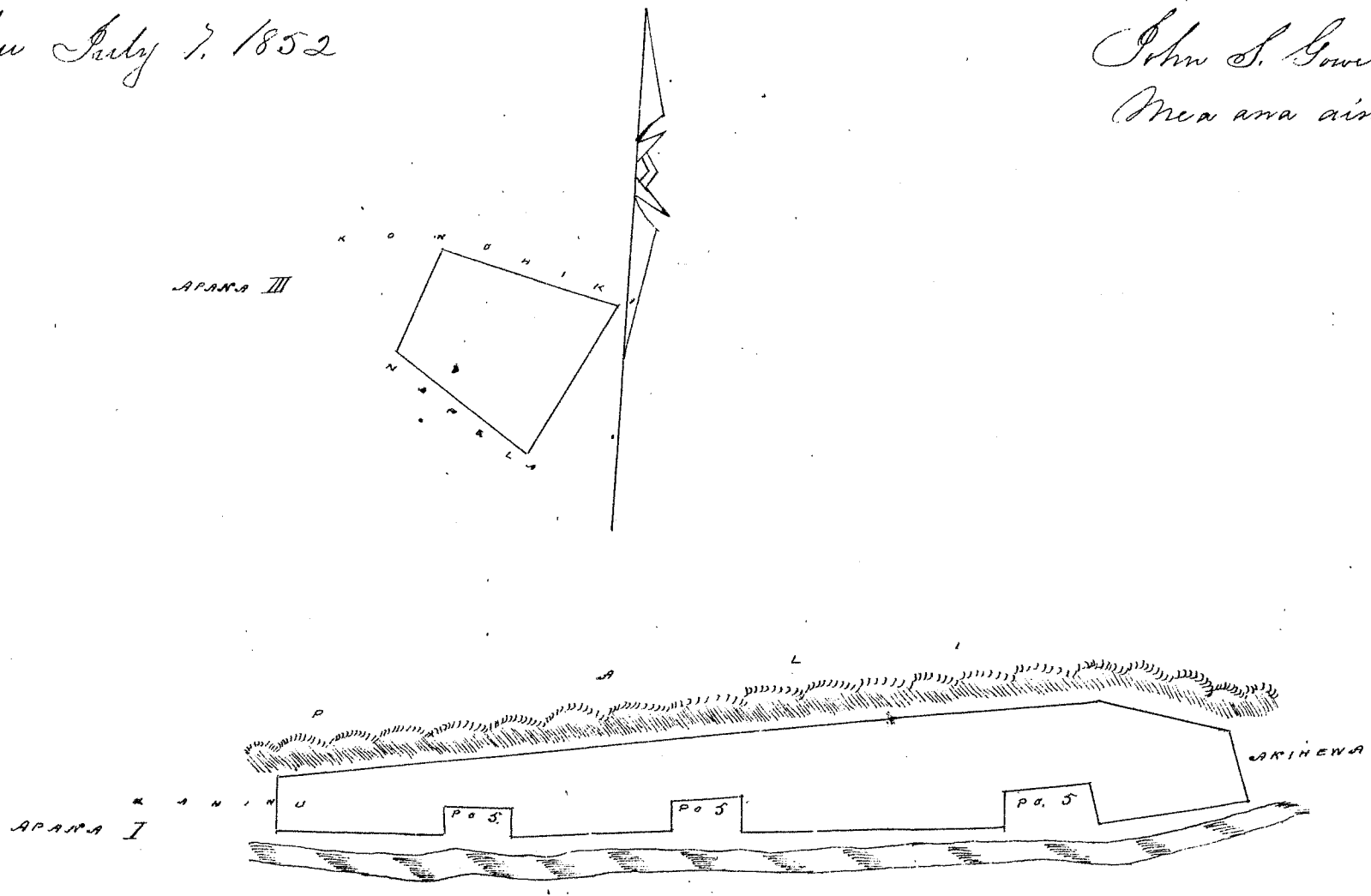

Uku Pau Loa #5
W. L. Lee
G. M. Robertson
J. Kekaulaha

Honolulu 27 Oct 1852

Ili Kapahua. E hoomaka ke ana ma ke kiki Komohana o keia, e pili ana me ke kiki Komohana ma Hema o Kamaka I Hema $13\frac{1}{2}$ Heke 234 Kaulahao, ma ka Poalima, Akau $68\frac{1}{2}$ Heke 41 Kh ma ke Kalamaiia, Akau $82\frac{1}{4}$ Heke 725 Kh. ma ke Kalamaiia, Ak. 2, Heke, 63 Kh. ma ke Poalima, Akau $7\frac{3}{4}$ Kom. 61 Kh. ma ke Kamaka, Hema $86\frac{1}{4}$ Kom. 182 Kh. ma ke Kamaka Hema 78 Kom. 535 Kh. ma ke Kamaka o Poalima Ak. $15\frac{1}{2}$ Kom. 134 Kh. ma ke Kamaka o Poalima, Hema $75\frac{1}{4}$ Kom. 63 Kh. ma ke Kamaka o Poalima, a hiki ma kahi i hooma ka'i, a maatoku via anapuni 1 Eka.

Wailuku Aug 12, 1852

John S. Lower
Mea ana aina

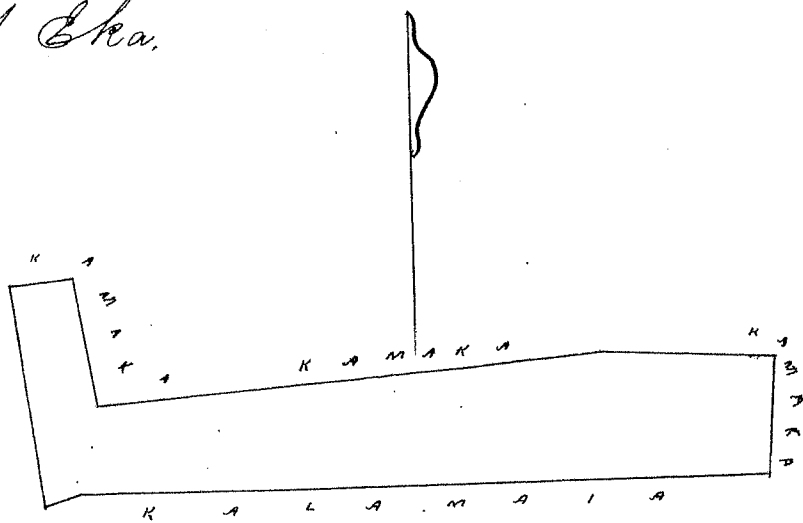

Nh. 2. Im 1.

Wku Pau Loa / 5
 W. L. Lee
 G. M. Robertson
 J. Kaulahao
 J. H. Smith

Honolulu 27 Oct 1852

Ili Kuumakahi. E hoomaka ke ana ma ke kiki Komohana o keia, e pili ana me ke kiki Kikumua o Kapaku, Ak. 80, Heke, 552 Kaulahao ma ke Kukulauakea o Luaku, Hema $20\frac{1}{2}$ Kom. 382 Kh. ma ke Pali, Hema $67\frac{1}{2}$ Kom. 284 Kh. ma kapahi Ak. 20 Kom. 411 Kh. ma ke Kapaku, a hiki ma kahi i hoomaka'i a maatoku via anapuni $15\frac{3}{4}$ Eka

Wailuku Aug 18 1852

John S. Lower
Mea ana aina

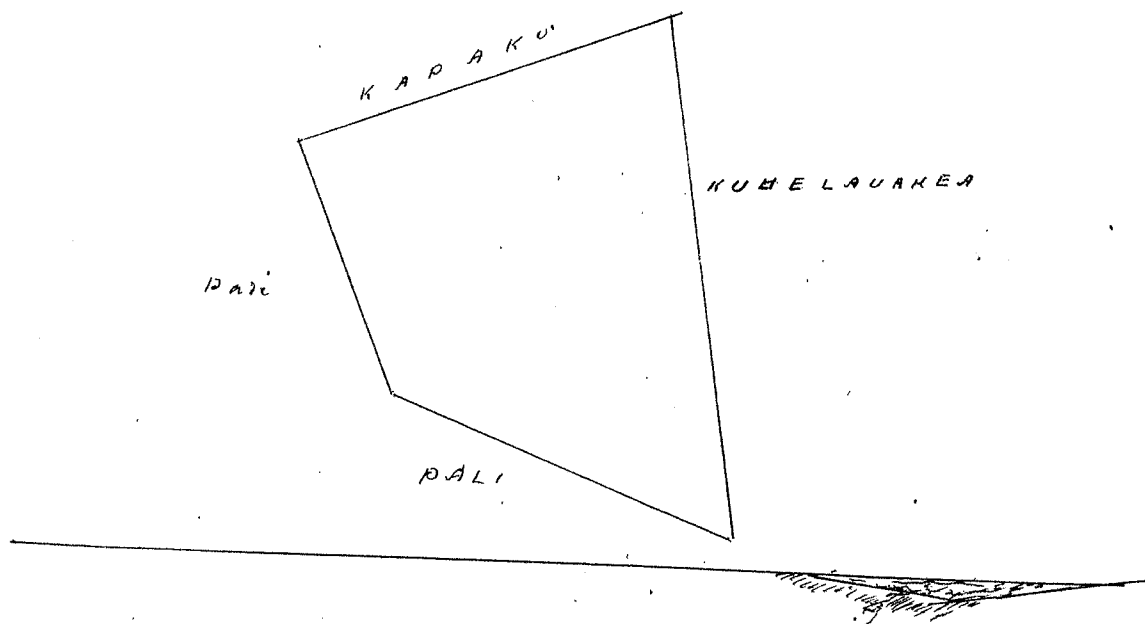

Wku Pau Loa / 6
 W. L. Lee
 G. M. Robertson
 J. Kaulahao
 J. H. Smith

Honolulu 27 Oct 1852.

344

Helu 6405 Kapahau

Hamakua Maui

Apana I. Ili Poolele. Kimita Komohana, Ehoomaka ke ana ma ke kiki Hikina o Keia,
 Akau $23\frac{1}{2}$ Komohana 20 Kaulahas ma Kahawai; Akau 60° Komohana 226 Kaulahas ma Kahawai
 Hema $63\frac{1}{2}$ Komohana 95 Kaulahas ma Kahawai; Hema 69° Komohana 81 Kaulahas ma Poalima
 Hema $14\frac{1}{2}$ Hikina 100 Kaulahas ma Kekahuna; Hema 79° Komohana 31 Kaulahas ma Kekahuna
 Hema $45\frac{1}{2}$ Komohana 75 Kaul. a hiki i Kela aiao, Hema $87\frac{1}{2}$ Hikina 130 Kaulahas ma Kahale
 Hema $74\frac{1}{2}$ Hikina 137 Kaulahas ma ka Pali, Akau 48 Hikina 186 Kaul. ma ka Pali
 a hiki ma Kahi i hoomaka i, a maloko ia anapuni; $65/100$ Eka.

Apana II. Aole hooa oia

John S. Gower
Ma ana aima

Wailuku, Aug. 25, 1852

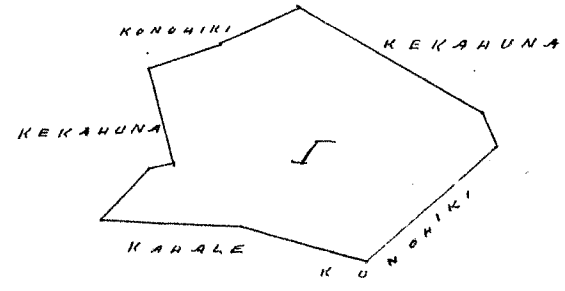

Sh. 2. In 1

Wku Pau Loa / L
 W. L. Lee
 G. M. Robertson
 J. Kekaulaha
 J. H. Smith

Honolulu 27 Oct. 1852

Helu 5514 Pohaiile

Hamakua Maui

Ili Kauhahikua. — Peahi Ehoomaka ke ana ma ke kiki Komohana o Keia,
 Akau 37° Hik. 268 Kaulahas ma Kahawai; Akau $71\frac{1}{2}$ Hik 112 Kaul. ma Kahawai
 Hema 30 Hikina 117 Kaulahas ma Poalima Hema 71° Kom. 177 Kaulahas ma Pali
 Hema 6 Kom. 186 Kaulahas ma Pali a hiki ma Kahi i hoomaka i, a maloko
 ia anapuni $27/100$ Eka.

Wailuku Sept. 6, 1852

John S. Gower
Ma ana aima

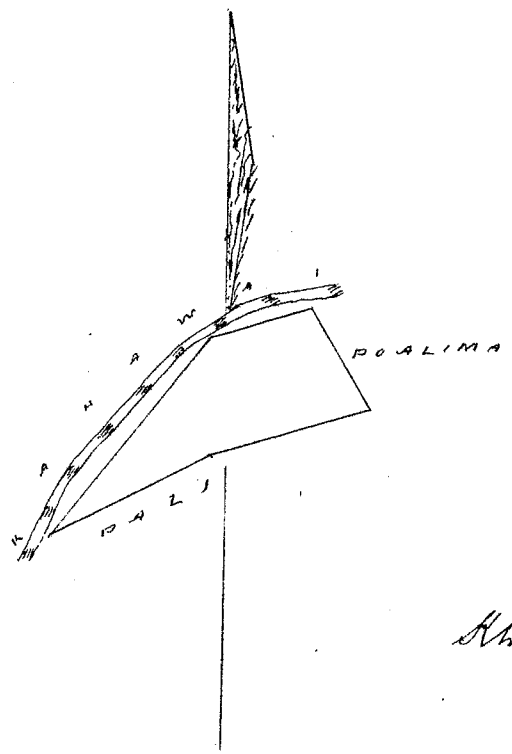

Sh. 2 In 1

Wku Pau ana off 4
 W. L. Lee
 G. M. Robertson
 J. Kekaulaha
 J. H. Smith

Honolulu, 27 Oct. 1852.

Mi Kalepule III E hoomaka ke ana ma ke kahi Komohana o keia e pili ana me ke kahi o ka Poalima Keia. Akau 65 1/4. Hikiina 355 Kaulahao ma Maikawaia. Akau 39 1/2 Kom. 237 Kaulahao ma ke Kuu. Hem 55 Komoh. 82 Kaul. ma Kounohiki. Akau 32 1/2. Kom. 56. Kaul. ma Kounohiki. Hem. 55 Kom 350 Kaul. ma Keiili Hema 45 3/4. Hiki 148 Kaul. ma ka auwai. Akau 64 1/2. Hikiin 71 Kaul ma ka Poalima Hem. 33 1/2 Hikiina 65 Kaul ma ka Poalima a hiki ma ka pahu mua a maloko oia anapuni, 85/100 Eka,

Wailuku, July. 7. 1852

John S. Lewis
Mea ana aina

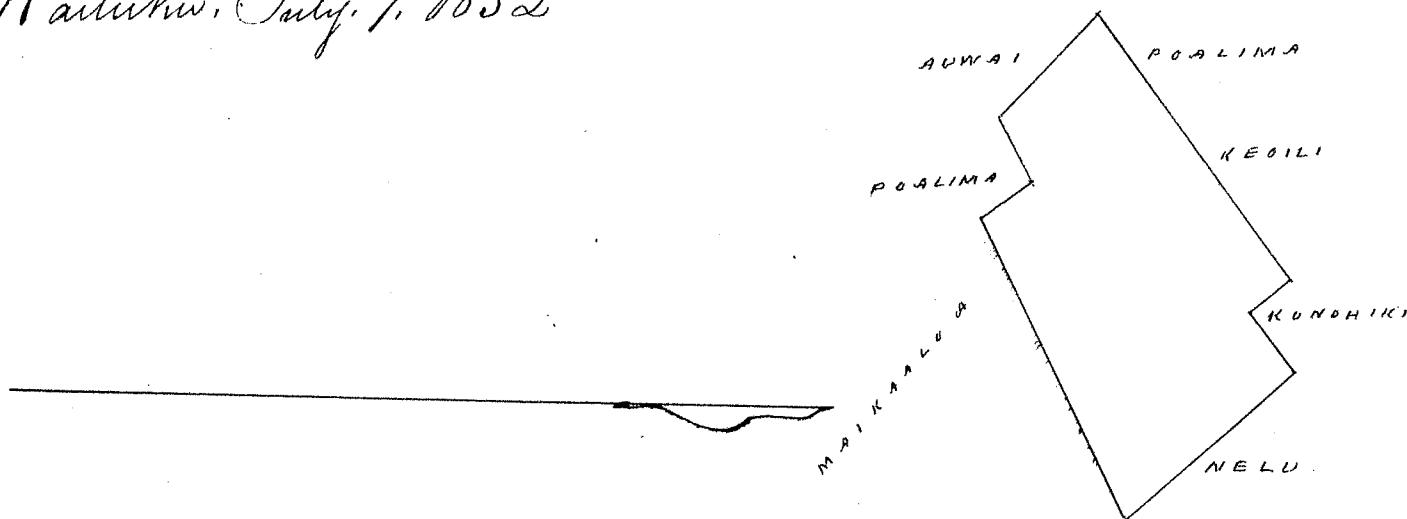

Uku Pau Loa \$4
W. L. Lee
G. M. Robertson
J. H. Smith

Honolulu 27 Oct 1852

Mi Kalelaw. E hoomaka ke ana ana ma ke kahi Komohana Hema o keia, e pili ana ma Ehu, Hema 82 1/2. Hikiina 119 Kaulahao ma Ehu. Akau 15. Hikiina 44 Kaulahao ma Kepaa. Akau 71. Hikiina 412. Kaulahao ma Kepaa. Akau 46 1/2. Hikiina 122 Kaulahao ma Kepaa. Poalima, Hema 25 1/2. Hikiina 144 Kaulahao ma Poalima Akau 76 1/4. Hikiina 146 Kaulahao ma Ehu. Akau 35 1/4. Komohana 193 Kaulahao ma Kula. Hema 71 Komohana 691 Kaulahao ma Kepaa. Hema 13 3/4. Hikiina 245 Kaulahao ma ka Poalima. Hema 86 3/4. Komohana 60 Kaulahao ma Poalima Hema 13 1/4. Hikiina 54 Kaulahao ma Ehu, a hiki ma kahi i hoomaka'i, a maloko oia anapuni 76/100 Eka,

Wailuku, Aug. 12, 1852,

John S. Lewis
Mea ana aina

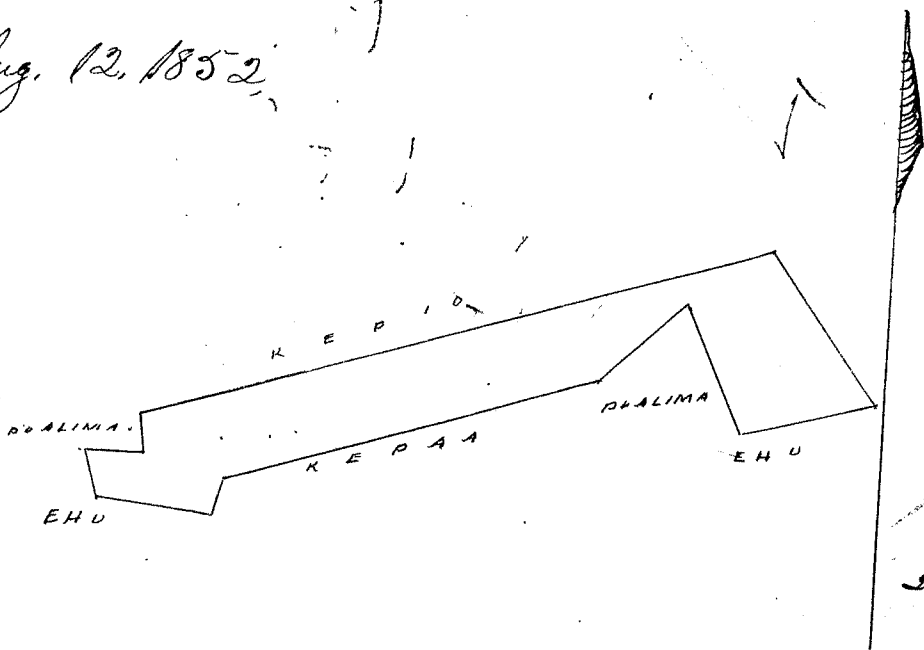

J. H. Smith

Uku Pau Loa \$4
W. L. Lee
G. M. Robertson
J. H. Smith

Honolulu 27. Oct. 1852

Helu 440 Keino

Waihee Maui.

Ili Paulani Choomaka ke ana ma ke hiki Hikiina. Iona, Akau $4\frac{3}{4}$ Komohana 198 Kaulahao
 ma ko Iona, Akau 76 Hikiina 505 Kaulahao ma ka auwai, Hema $5\frac{5}{4}$ Hikiina 85 Kaulahao
 ma ka auwai, Hema $3\frac{3}{4}$ Komohana 219 Kaulahao ma ka Poalima, Akau 65 Komohana 77
 Kaulahao ma ko Wahalua, Hema $1\frac{1}{2}$ Komohana 83 Kaulahao ma ko Wahalua, Hema 59
 Hikiina 59 Kaulahao ma ko Wahalua, Hema $2\frac{8}{4}$ Komohana 38 Kaulahao ma Konohiki
 Akau 84 Kom. 380 Kaulahao ma ka auwai, a hiki ma ka hiki i hoomaka i
 a maloku oia anapuni, $\frac{4}{100}$ Eka,

Wailuku, July, 10, 1852.

John S. Gower
Ma ana aina

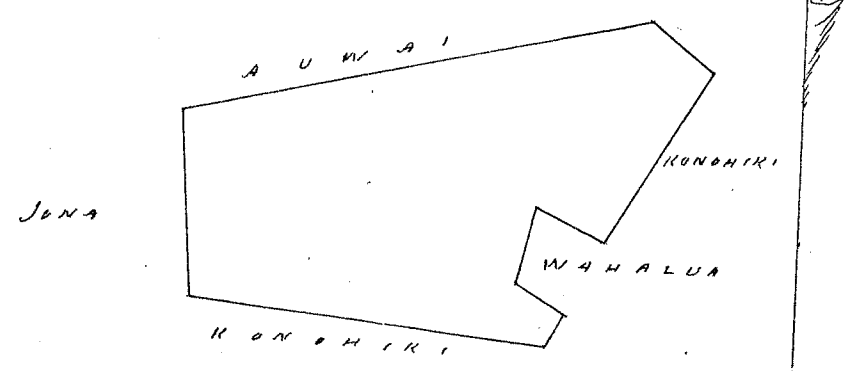

Nh 2 In 1.

Wm Pau Loa / 5
 W. L. Lee
 G. M. Robertson
 J. Kikaulahao
 C. H. Smith

Honolulu 27 Oct 1852

Helu 444 Keapu

Waihee Maui

Ili Papaina Choomaka ke ana ma ke hiki Komohana. Laupahulu, II Apama
 Akau 67 Hikiina 75 Nh. Laupahulu II
 Akau $2\frac{1}{2}$ Kom. 55 Nh. Kawahu
 Hema $6\frac{3}{2}$ Kom. 145 " Poalima
 Hema $5\frac{6}{2}$ Kom. 125 " Laupahulu Apama III
 Hema $6\frac{4}{4}$ Hiki 55 " Konohiki
 Akau 60 Hikiina 162 " Kaula, a hiki ma ka pahu mua, a maloku oia
 anapuni, $\frac{14}{100}$ Eka,

Wailuku, July, 7, 1852

John S. Gower
Ma ana aina

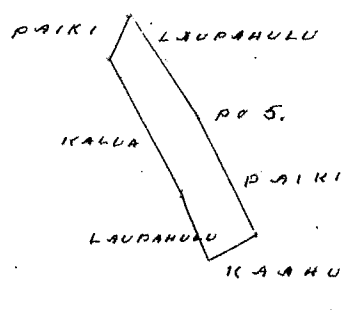

Nh 2 In 1

Wm Pau Loa / 4

W. L. Lee
 G. M. Robertson
 J. Kikaulahao
 C. H. Smith

Honolulu 27 Oct 1852

Keleu 499 Auwae

Waikuu Maui 347

Ili Halelau. E hoomaka ke ana ma ke kahi Komohana Heema o keia, e pili ana me kea Poalima
 Heema, 78° Hikina. 152 Mh. ma Poalima
 Akau, 64° Hikina. 77" Kapulu.
 Akau, 54 1/4° Komoh. 130" Ehu.
 Akau, 86 3/4° Komoh. 98" "
 Heema, 4 1/4° Komoh. 78" " a hiki ma kahi i hoomaka'i, a malokeo via anapuni
 ni 13/100 Eka.

Waikuu, Aug 12, 1852

John S. Gower
Moa ana aina

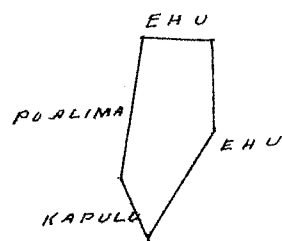

Mh 2 In 1

Wku Pau Loa # 5
 W. L. Lee
 G. W. Robertson
 J. Kaulahao
 J. H. Smith

Honolulu 27 Oct 1852

Keleu 3447 Keleu

Waikuu Maui

Apana I Ili Halelau. E hoomaka ke ana ma ke pahu 12. Ehu, ke kahi Akau o keia.
 Heema 68° Komohana 652 Kaulahao. Ehu
 Heema 8° Hikina 68 " Poalima
 Akau 71° Hikina 692 " Waiwaiole
 Akau 34 1/4° Komohana 118 " Kula, a hiki ma kahi i hoomaka'i, a malokeo via
 anapuni, 64/100 Eka,

Apana II. Ua haalele oia

John S. Gower.
Moa ana aina

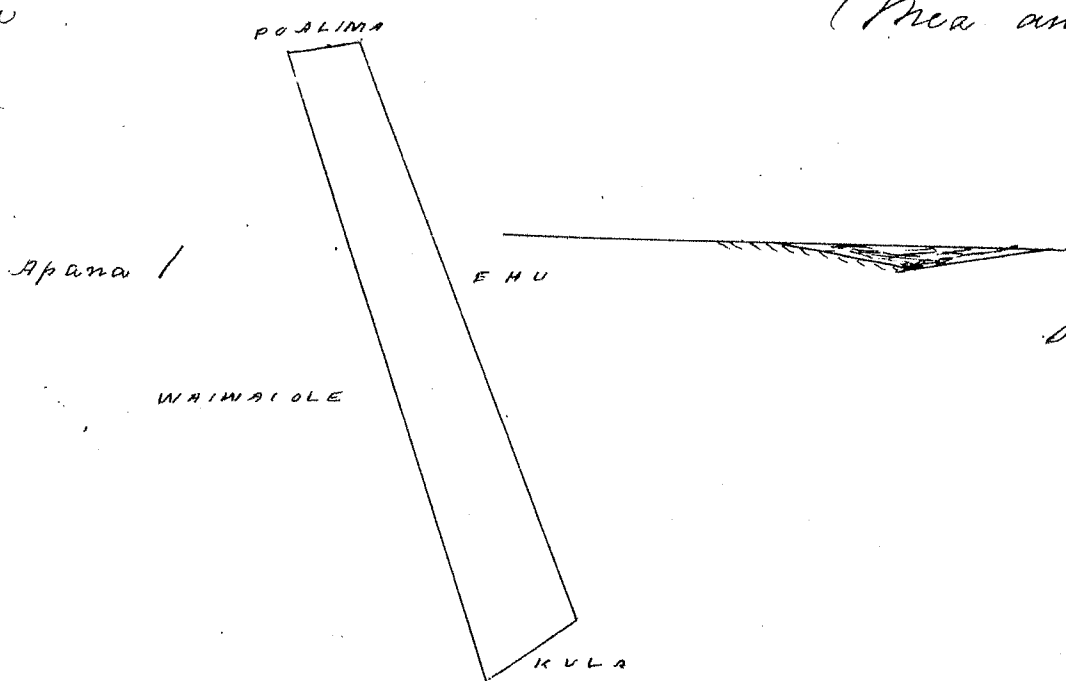

Mh 2 In 1

Wku Pau Loa # 4
 W. L. Lee
 G. W. Robertson
 J. Kaulahao
 J. H. Smith

Honolulu, 27 Oct. 1852

Kele 3429 Koupe

Waiehu Maui

Ili Kapalaua, Chomaka ke ana ma ke kiki Komohana o Kamaka I ke kiki Komohana Kona keia
 Akau 10° Komohana 126 Kaulahas ma Kula,
 Akau 61° Hikina 153 " Birch.
 Akau 66 1/4° Hikina 185 " "
 Hema 19 1/4° Hikina 64 " Poalima
 Hema 63° Komoh. 99 " "
 Hema 25° Hikina 73 " "
 Akau 58 1/2° Hikina 109 " "
 Akau 33 1/4° Komoh. 64 " "
 Akau 72 1/4° Hik. 364 Alanui,
 Hema 32 1/2° Hike 175 Kula,
 Hema 60 3/4° Komoha. 145 Kamaka,
 Akau 29° Kom. 54 " Poalima
 Hema 70° Kom. 194 " "
 Hema 86 1/2° Kom. 279 " Kamaka,
 Hema 62 1/2° Kom 140 Kh. Kamaka, a hiki ma kahi i hoomaka'i
 a maloke ia anapuni, 1 1/100 Eka

Wailuku Aug. 12, 1852.

John S. Gower.
Mea ana aina

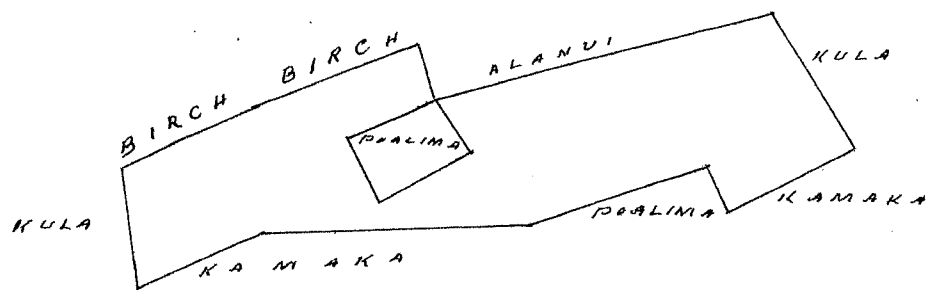

2 Kh 1 En.

Uku Pau Loa # 6

W. L. Lee
G. M. Robertson
J. Kekaulahas
D. H. Smith

Honolulu 27 Oct 1852

Kele 3431 or 3437 Kalamoia

Waiehu Maui

Ili Kapalaua, Chomaka ke ana ma ke kiki Kona keia.
 Akau, 13° Komohana, 1.45 Kaulahas, Kula,
 Akau, 76 3/4° Hikina, 2.45 " "
 Akau, 14 3/4° Komohana, 1.31 " "
 Akau, 71° Hikina, 1.20 " "
 Hema, 24 1/2° Hikina, 1.28 " Poalima
 Akau, 71 1/4° Hikina, 1.39 " "
 Akau, 82 1/2° Hikina, 7.23 " Kamahana,
 Hema, 13° Hikina, 2.33 " Kono hiki
 Hema, 68 1/2° Komohana, 1.17 " "
 Hema, 86 1/2° Komohana, 7.94 " "
 Hema, 77 1/2° Komohana, 3.51 " a hiki i kahi
 i hoomaka'i a maloke ia, anapuni 2 7/100 Eka.

Wailuku, Aug 12, 1852

John S. Gower.
Mea ana aina

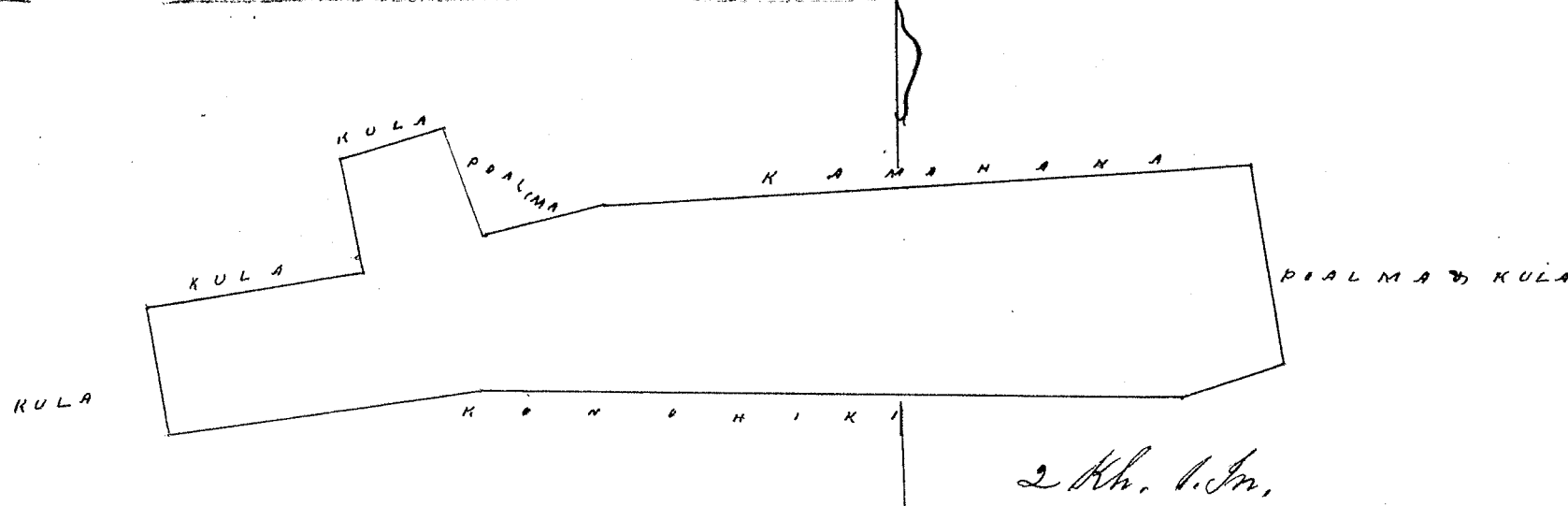

Wku Pau Leaf 6
 W. L. Lee
 G. M. Robertson
 J. Hekaulahao
 J. H. Smith

Honolulu 27 Oct 1852

Hulu 3457 Kamaka

Waiehu Maui

Ili Kapalawa. E huomaka ke ana ma ke kahi Komohana o keia, i pili ana me ke kahi Komohana Heema o Kaupē.

Akau.	6 2/2.	Hikina,	140.	Kaulahao,	Anwai,
Akau.	8 6/2.	Hikina,	279.	"	Kaupē,
Heema.	2 1/4.	Hikina,	87.	"	Poalima,
Akau.	60 3/4.	Hikina,	354.	"	Poalima, & Kaupē,
Heema.	20 3/4.	Hikina,	165.	"	Kula, & Poalima,
Akau.	7 4/2.	Hikina,	99.	"	Poalima,
Heema.	7.	Hikina,	163.	"	Kula,
Heema.	8 4/2.	Komohana,	86.	"	Konohiki,
Akau.	7 3/4.	Komohana,	61.	"	"
Heema.	8 6/4.	Komohana,	182.	"	"
Akau.	13.	Komohana,	101.	"	Poalima,
Heema.	8 3/4.	Komohana,	76.	"	"
Heema.	16.	Hikina,	106.	"	"
Heema.	78.	Komohana,	462.	"	Konohiki,
Akau.	15 1/2.	Komohana,	134.	"	Poalima,
Heema.	75 1/4.	Komohana,	63.	"	Poalima,
Akau.	18.	Komohana,	70.	"	"

a kahi ma kahi i huomaka i, a onaloka oia awapuni, 15 2/100 Eka.

Waiehu, Aug 12, 1852.

John S. Lowry,
 Mea ana ana.

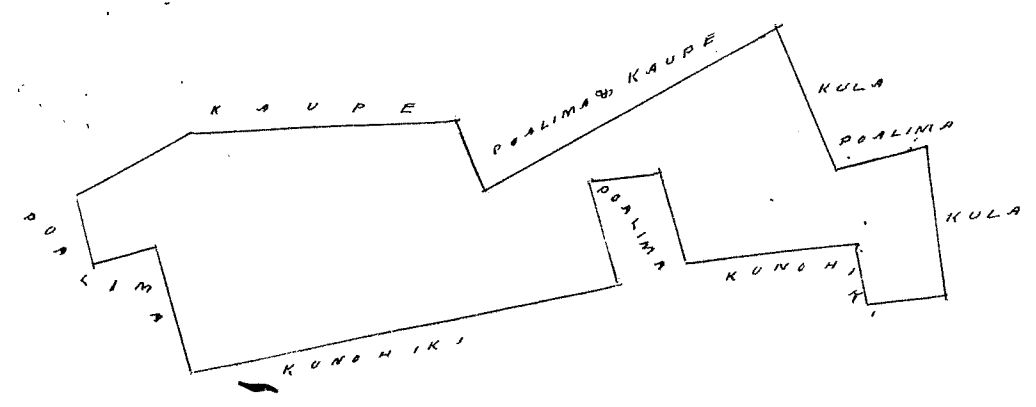

Wku Pau Leaf 6
 W. L. Lee
 G. M. Robertson
 J. Hekaulahao
 J. H. Smith

Honolulu 27 October 1852

Hulu 5497 Kawahilakole

Hamakua, Maui.

Hi Kahoumuka, Ahupuaa Pahi. E hoomaka ke ana ma ke kahi Hema o Keia

Apana I	Akau.	151°	Hikina.	3,17.	Kaulahas.	a hiki i kela ana
	Akau.	42°	Komohana.	3,93.	"	Pali
	Hema.	72°	Komohana.	3,33.	"	"
	Akau.	30°	Komohana.	1,19.	"	"
	Akau.	25°	Komohana.	1,54.	"	"
	Akau.	17°	Komohana.	1,32.	"	"
	Hema.	16 1/2°	Komohana.	2,03.	"	Hakawai
	Hikina.	Pono.	"	67.	"	Poalima
	Hema.	14°	Hikina.	58.	"	"
	Hema.	81 3/4°	Komohana.	1,65.	"	"
	Hema.	55 1/2°	Hikina.	5,62.	"	Hakawai
	Hema.	41°	Hikina.	2,41.	"	Pali.

a hiki ma kahi i hoomaka i a maloko via anapuni, 2 Eka,

Apana II Aole Loa via
Wailuku, Sept. 6, 1852

John S. Gower
Mea ana aina

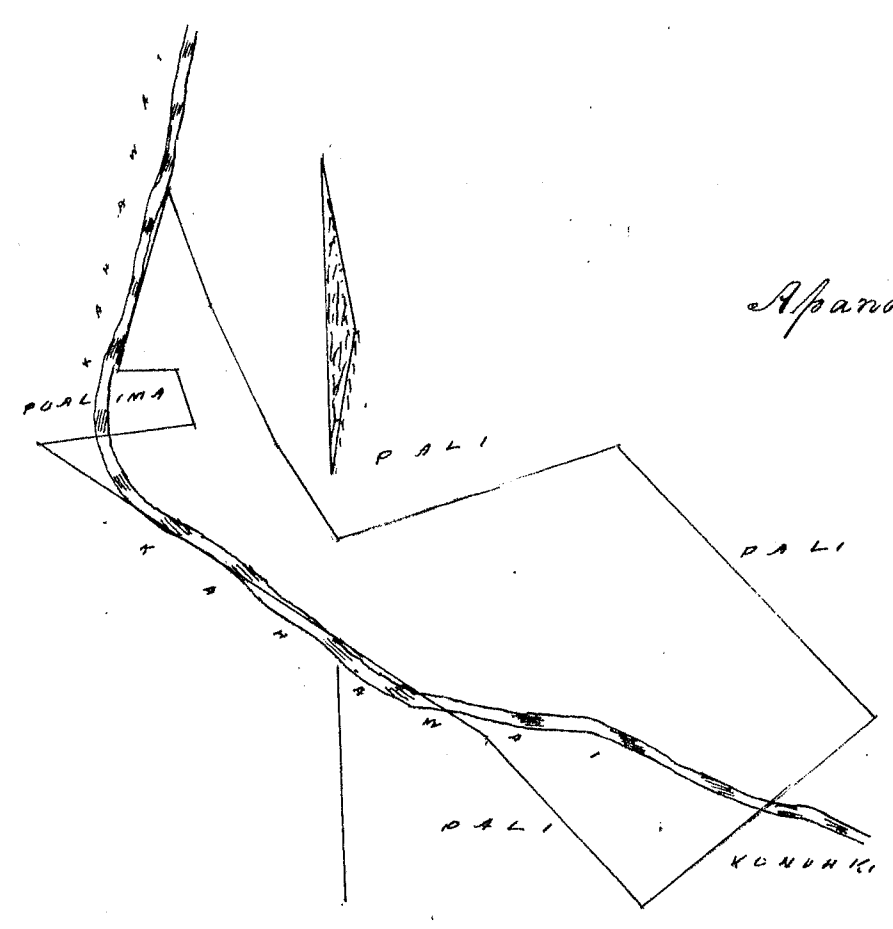

Uku Pau Loa # 6
W. L. Lee
S. M. Robertson
J. Kaulahas
J. H. Smith

Honolulu 27 Oct 1852

Hulu 4562 Namokuelua

Hamakua, Maui

Hi Pahaa Haitu. E hoomaka ke ana ma ke kahi Komohana Hema o Keia mai
ke kahi Akau o Kaai, Apana II Akau 80 Hike 288 Kaulahas, Akau 80° Hikina
121 Kaulahas ma ka Pali, Akau 37 Hikina 104 Kh. ma ka pali, Akau 81° Komohana
324 Kh. ma ka pali, Akau 15 3/4° Komohana 683 Kh. ma ka pali, Hema 65 1/2° Hikina
184 Kh. ma ka pali, Hema 16° Hikina 259 Kh. ma ka pali, Hema 69 1/4° Hikina
335 Kh. ma ka pali, Hema 18 3/4° Hikina 316 Kh. ma ka pali, Hema 56 Komohana
255 Kh. ma ka pali, Akau 36 1/2° Komohana 140 Kh. ma ka Poalima, a hiki ma ka
hi i hoomaka i, a maloko via anapuni, 2 1/10 Eka,

Wailuku Aug 13, 1852

John S. Gower
Mea ana aina

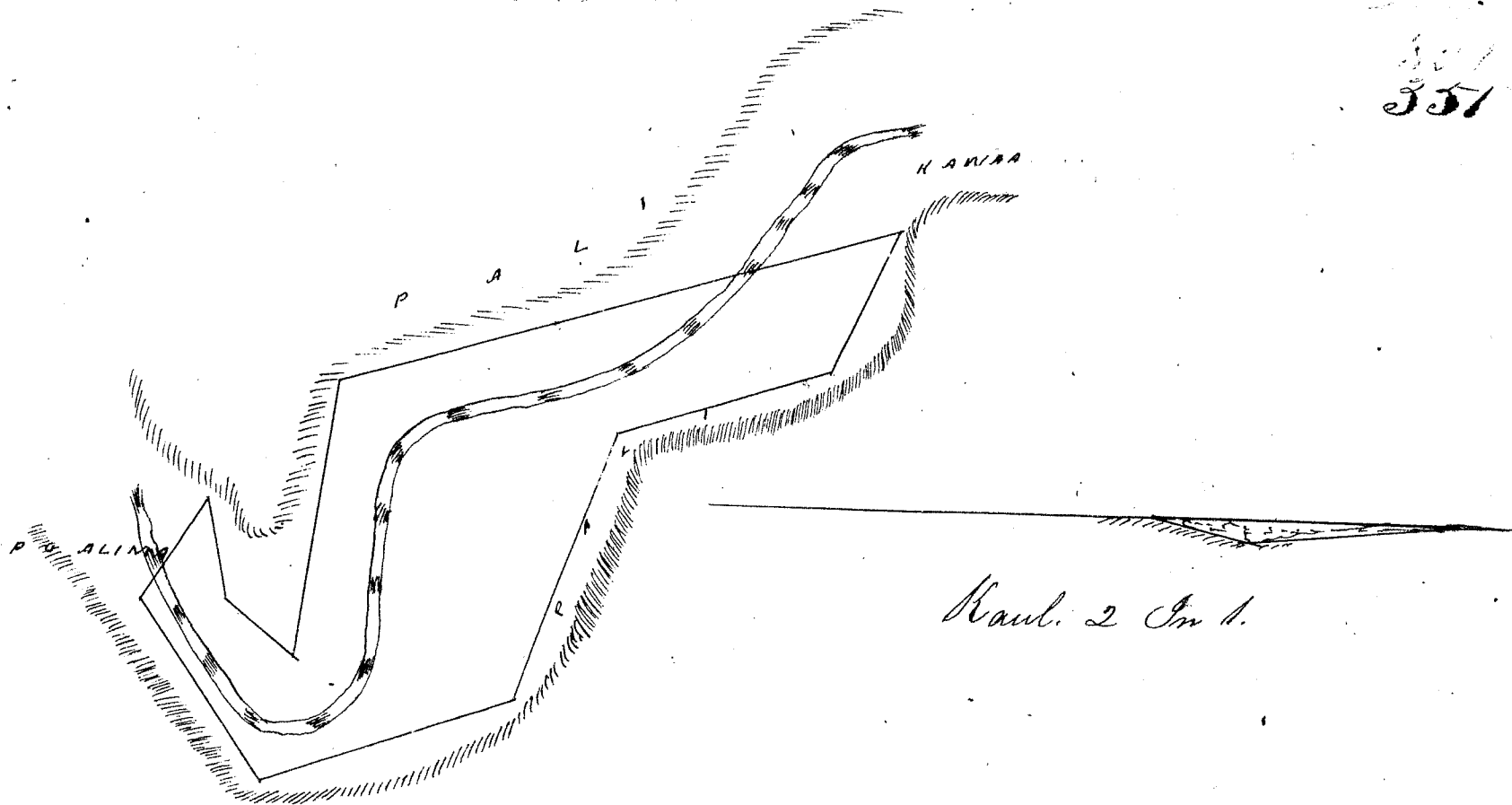

Uku Pau Loa / 6

W. L. Lee
G. M. Robertson
J. H. Smith

Honolulu 27 Oct 1852

Hulu 7686 Hawaii

Waiheo Maui

Apana I Ili Papaina. E hoomaka ke ana ma ke kiki. Hikiina o Laupahulu Apana I.
 Akae 29 3/4. Komohana 125 Kaulahas. ma Laupahulu. Hem. 58 1/2 Kom. 148 Kaul. ma Laupahulu
 Hema 35. Hike 72 Kaul. ma Laupahulu. Hem. 68 Kom. 190 Kaul. ma Napela. Ake. 23. Kom. 95
 Kaul. ma Poalima. Hem. 61 Kom. 47 Kaul. ma Poalima. Ake. 25 1/2. Kom. 39 Kaul. Laupahulu Apana
 II Ake. 65 1/2. Hikiina 130 Kaul. ma Kaahu. Ake. 16. Kom. 97 Kaul. ma Kaahu. Ake. 60 1/2. Hike 80 Kh
 ma Auwai. Hema 21 3/4. Hike. 88 Kh. ma Poalima. Ake. 70. Hike. 122 Kaul. ma ke Poalima. Hem. 42 1/2
 Hike 22 Kh. ma Poalima. Ake. 60. Hike 38 Kh. ma Kaahu. Ake. 60. Hike 38 Kh. ma Kaahu. Ake. 21
 Kom. 42. Kh. ma Kaahu. Ake. 61 1/2. Hike 75 Kh. ma Kaahu. Hem. 35 1/4. Ake 220 Kh. ma Ake
 Hema. 68. Komohana 119 Kh. ma ke Kawamaku, a hiki ma Mahi i hoomaka i, a maloko via
 awapuni, 66/100 Eka.

Apana II Komohana. — Ua ana mo o A. F. Turner.

Wailuku, July 7. 1852

John S. Gower
Mea ana aia

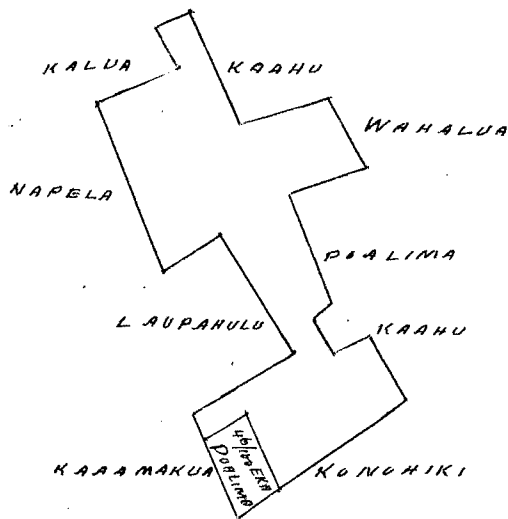

Kaulahas 2 Incha 1.

Uku Pau Loa / 4

W. L. Lee
G. M. Robertson
J. H. Smith

Honolulu, 27 October, 1852.

Kulu 3433 Kouana

Waiau Maui

Ahupuaa Pohakunui, E hoomaka ke ana ma ke kahi Kouhana o keia, a ipiti ana me
 ka Paa. Akaun 48° Hikina 302 Kaulahas ma Paa, Aema 12° Hikina 122 Kaulahas
 ma Poalima Aema 58 1/2 Kouhana 105 Kaulahas ma Poalima, Aema 30 Hikina 59 Kaul.
 ma Poalima, Akaun 55 3/4° Hikina 243 Kaulahas ma Poalima, Aema pona, 363 Kaul.
 ma Paa, Akaun 39 3/4° Hikina 108 Kaulahas ma Poalima Aema 53 3/4° Hikina 128
 Kaulahas ma Poalima, Aema 34 1/2, Kouhana 99 Kaulahas, ma Poalima Akaun
 72 3/4, Kouhana 111 Kaulahas ma Poalima, Aema 6 3/4, Kouhana 226 Kaulahas
 ma Kula, Aema 43 Kouhana 240 Kaulahas ma Auwai, Akaun 56 1/2, Kouha-
 ma 42 Kaulahas, ma Kula, Akaun 10 3/4, Hikina 167 Kaulahas, ma Kula, Akaun
 20 3/4, Kouhana 179 Kaulahas ma Kula, Akaun 25 3/4, Kouhana 176 Kaulahas
 ma Kekai, Akaun 22 3/4 Kouhana 185 Kaulahas ma ka Poalima, a hiki
 ma kahi i hoomaka'i, a maloko via anapuni 2 1/10 Eka,

Kailuku Aug 12, 1852

John S. Low
Mea ana aina

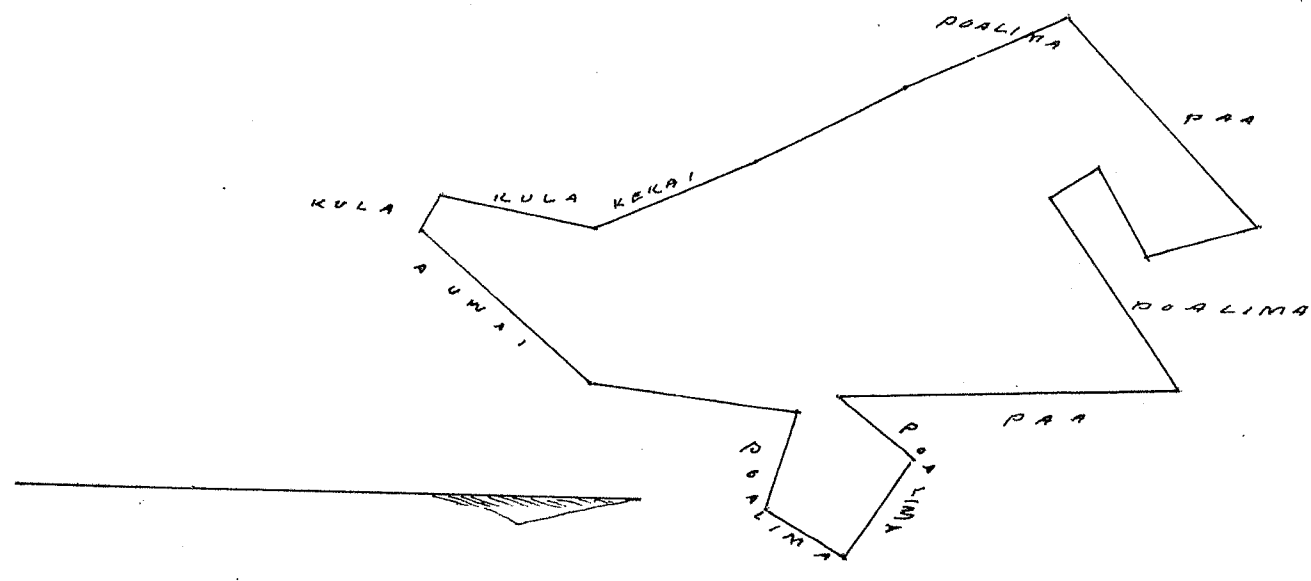

Uku Pau Loa # 6

W. L. Lee
 G. M. Robertson
 J. Akaulahas
 J. H. Smith

Honolulu 27 October 1852

Kulu 3458 Kikaha

Waiau Maui

Ili Pakuanui, E hoomaka ke ana ma ke kahi Aema o keia, Akaun 54 3/4, Hike 407 Kh.
 ma Makahiki, Akaun 41° Kom. 67 Kaul. ma Poalima, Akaun 59 1/2, Hike 76 Kaulahas,
 ma Poalima, Aema 37 1/4, Hike 54 Kaul. ma Poalima, Akaun 41 3/4, Hike 88 Kaulahas
 ma Makahiki, Akaun 37 1/2, Kom. 45 Kh. ma Kouhiki, Akaun 52, Hike 130 Kaulahas
 ma Kouhiki, Akaun 18, Kom 139 Kh. ma Kouhiki, Aema 80 3/4 Kom. 353 Kaulahas
 ma Kouhiki, Akaun 22 1/4 Kom. 99 Kh. ma Kouhiki, Aema 6 1/2, Kom. 100 Kaulahas
 ma Kouhiki, Aema 23, Hike 276 Kh. ma Poalima, Aema 58 1/2, Kom 74 Kaulahas
 ma Poalima, Akaun Akaun 46 1/4, Kom. 87 Kh. ma Poalima, Aema 20 1/2, Kom. 139 Kh.
 ma Pa, Aema 16 Hike 220 Kh. ma Pa a hiki ma kahi i hoomaka'i,
 a maloko via anapuni, 18 7/100 Eka

Kailuku Aug 12, 1852

John S. Low
Mea ana aina

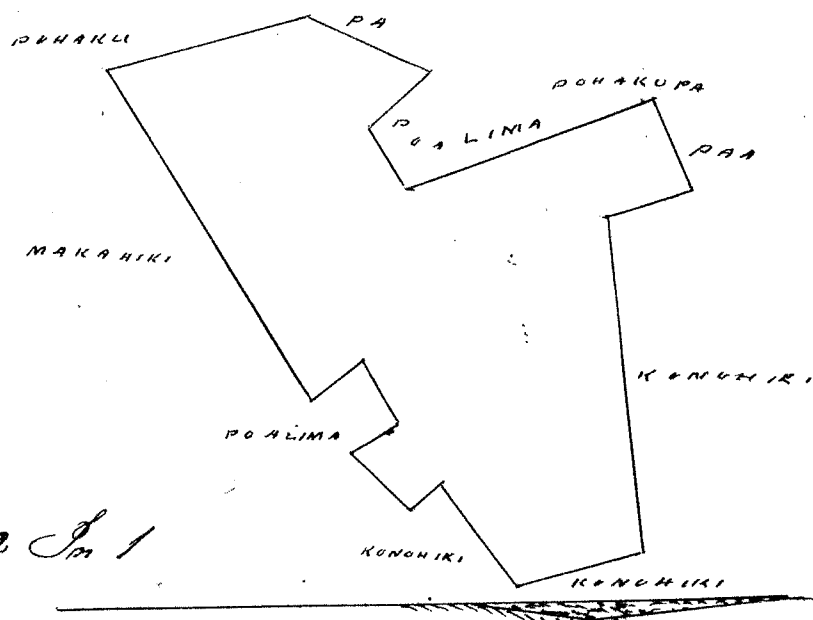

Kh 2 Im 1

Uku Pau Loa / 6

353

W. L. Lee

G. M. Robertson

J. Kekaulahao

J. H. Smith

Honolulu 27 Oct. 1852

Hele 5490 & 3970 Hoas

Hamakualoa, Maui

Apana I. Kalua Kaholua. - Kale Kuiuaha, Komohana, E hoomaka ke ana ma ke kahi Akaui o keia, e pili ana me ka Poalima Hema 75 1/2. Komohana 119 Kaulahas, ma Komohiki Hema 19 1/2. Hikitina 356 Kaulahas ma ka Pali, Akaui 59 3/4. Hikitina 149 Kaulahas ma ka Hookeaa, Akaui 9 1/2. Kom. 290 Kaulahas ma ka Pali, Akaui 8 1/4. Komohana 82 Kaulahas ma ka Poalima, a hiki ma kahi i hoomaka i, a maloko via anapuni, 57/100 Eka.

Apana II Ili Kalua Kaholua, Kula. E hoomaka ke ana ma ke kahi Hikitina Akaui o keia. Akaui 89 Komohana 400 Kaulahas, a hiki malalo, Hema 77 1/2. Komohana 180 Kaul. ma Kahawai, Hema 73 Hikitina 579 Kaulahas a hiki malua, Akaui 6. Hikitina 200 K. a hiki ma kahi i hoomaka i a maloko via anapuni 67/100 Eka

Maui Apana Kue na hua ole,
Wailuku, Sept. 6, 1852

John S. Lower
Ma ana aina

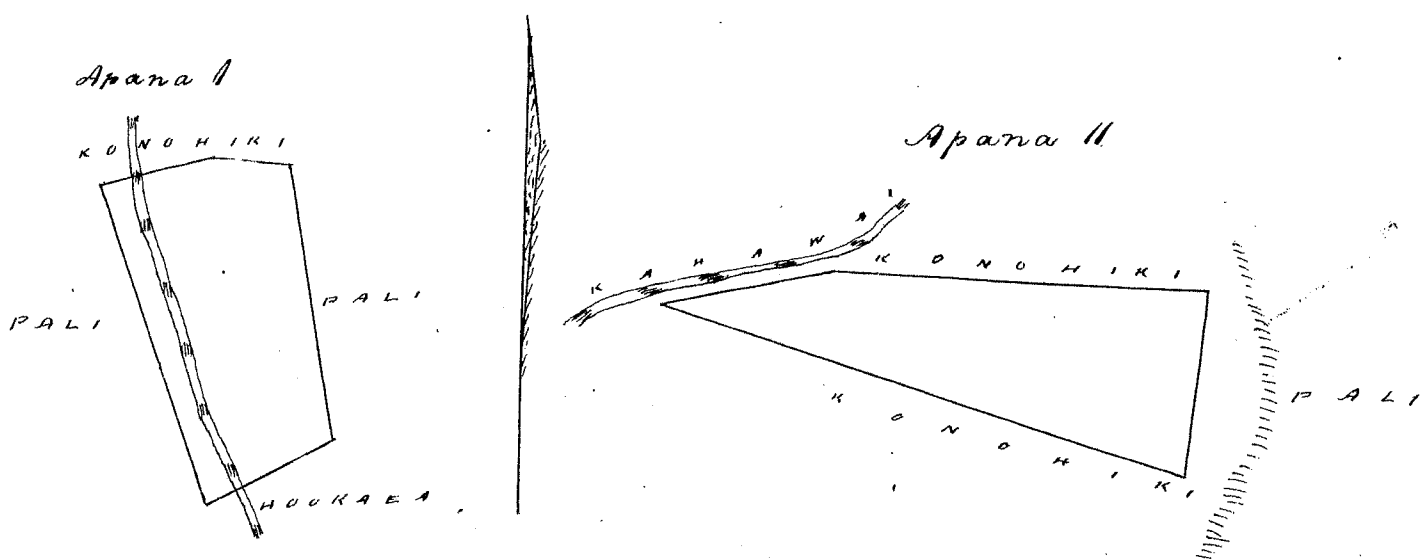

Uku Pau Loa / 5

W. L. Lee

G. M. Robertson

J. Kekaulahao

J. H. Smith

Honolulu 27 Oct. 1852

Hele 3718 Iona Maitualoa

Waieae, Maui

Ili Paulani E hoomaka ke ana ma ke kahi Hikitina o Kahinu Apana III Hema 87 1/4. Hikitina 180 Kaulahas ma ka Auwai, Akaui 1 1/2. Komohana 46 Kaulahas ma Poalima Akaui 88. Hikitina 146 Kaulahas, ma Poalima, Hema 6 1/2. Hikitina 27 Kaulahas ma ka Poalima Akaui 88 1/4. Hikitina 480 Kaulahas ma ka Auwai, Akaui 4 1/2 Komohana 55 Kaulahas, ma ka Poalima. Hema 84. Hikitina 152 Kaulahas, ma ka Poalima, Hema 10 1/2. Hikitina 54 Kaula ma ka Poalima, Hema 84 1/2. Hikitina, 160 Kaulahas, ma ka Auwai, Akaui 4 3/4. Komohana 195. Kaulahas, ma ka Keino, Hema 77 Kom. 64 Kh ma ka Kahikiula, Kom. 83 1/2 Kom. 420 Kh, ma ka Kahikiula, Hema 87 Kom. 80 Kh ma ka Poalima, Hema 81 Kom. 2,000 Kh ma ka Kahikiula Hema 87 Kom. 293 Kh, ma Kahikiula Hema 24 Komohana 79 Kh, ma ka Kahinu, a hiki ma kahi mua, a maloko via apuni 1.13 Eka

Wailuku July 7, 1852

John S. Lower
Ma ana aina

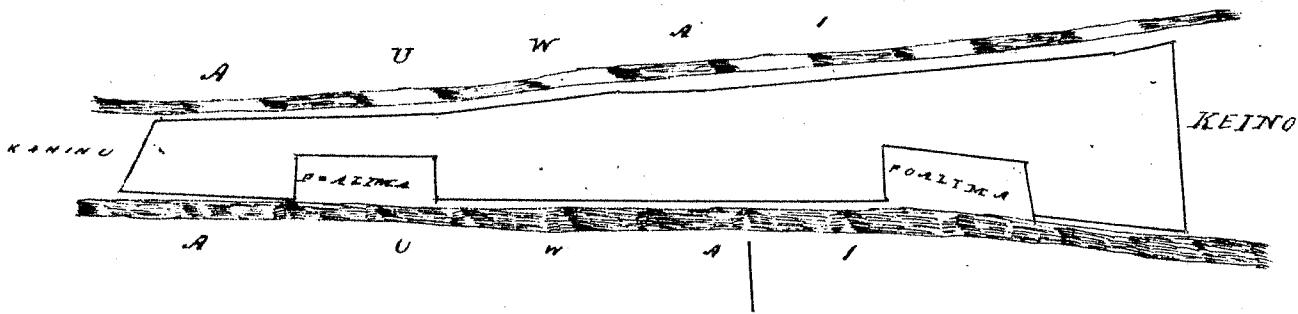

Uku Pau Loa # 5

W. L. Lee
 G. M. Robertson
 J. Hekeaulahas
 J. H. Smith

Honolulu 27 Oct 1852

Heleu 3428 Kikai

Waiuku Maui

Ili Pohakunui. E hoomaka ke ana ma ke kahi Komohana Nema o Keia. Akaun 61' Hikiina 720
 Kaulahas ma Komohiki. Akaun 25 3/4' Komohana 176 Kaulahas ma ke Kuaana, Nema 60 1/2' Komohana 58
 Kaulahas ma Poalima. Akaun 28' Komohana 154 Kaulahas ma ke Poalima, Akaun 55 1/4' Komohana 249
 Kaulahas ma Pa, Nema 28 1/2' Hikiina 168 Kaulahas ma ke Poalima Nema 53 Komohana 60
 Kaulahas ma Poalima, Akaun 27 1/2' Komohana 154 Kaulahas ma ke Poalima, Nema 65 1/4' Komohana 328
 Kaulahas ma Pa, Nema 20 3/4' Hikiina 307 Kaulahas ma ke Komohiki, a hiki ma kahi i hoomaka i
 a maloko oia anapuni 2 Eka,

Waiuku Aug 12, 1852

John S. Lower,
 Uea ana aia

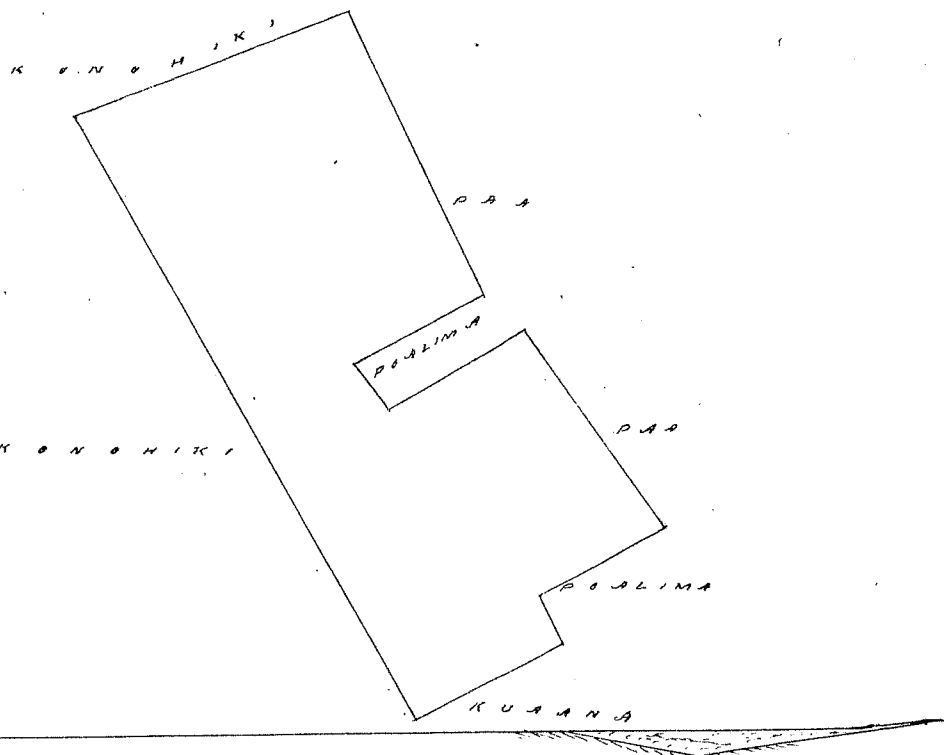

Kh. 2. Cu. 1.

Uku Pau Loa # 6

W. L. Lee
 G. M. Robertson
 J. Hekeaulahas
 J. H. Smith

Honolulu 27 Oct 1852

Heleu 3373 Pu

Waiuku Maui

Wahale 1 Ili Pono. E hoomaka ke ana ma ke kahi Nema o Keia a pili ana ma ke Poalima
 Akaun 36' Kom. 143 Kaulahas ma ke Poalima, Nema 36 3/4' Kom. 58 Kaulahas ma Poalima. Akaun 47 1/4'
 Komohana 79 Kaulahas ma ke Pilipowahine o Lane Akaun 74 1/4' Komohana 116 Kaulahas ma ke
 Pilipowahine o Lane, Akaun 24 3/4' Hikiina 240 Kaulahas ma ke Poalima, Nema 60 1/4' Hikiina
 381 Kh. ma ke Napae o Poalima, Nema 37 1/2' Komohana 242 Kaulahas ma Kula,
 a hiki ma kahi i hoomaka i a maloko oia anapuni 77/100 Eka,

Mahele 11. E hoomatika ke ana ma ke kiki Akaui e keia, e pili ana one ke kiki Komohana
o Napae, Hema 62 1/4; Hikina 364 Kaulahas ma ke Napae, Hema 54 1/2; Hikina 53 Kaulahas ma Poalima
Hema 33 3/4 Komohana 130 Kaulahas ma Poalima, Akaui 73 1/2; Komohana 58 Kaulahas ma Poalima
Hema 13 1/2; Komohana 127 Kaulahas ma Poalima, Akaui 65 1/2; Komohana 430 Kaulahas ma ke Pilipe
wahine D Lane, Akaui 36 1/2; Hikina 305 Kaulahas ma Para, a hiki ma kahi i hoomatika'i a
onalohe ia anapuni, 1 1/100 Eka,

Wailuku, Aug. 20, 1852.

John S. Lower,
Mea ana aina

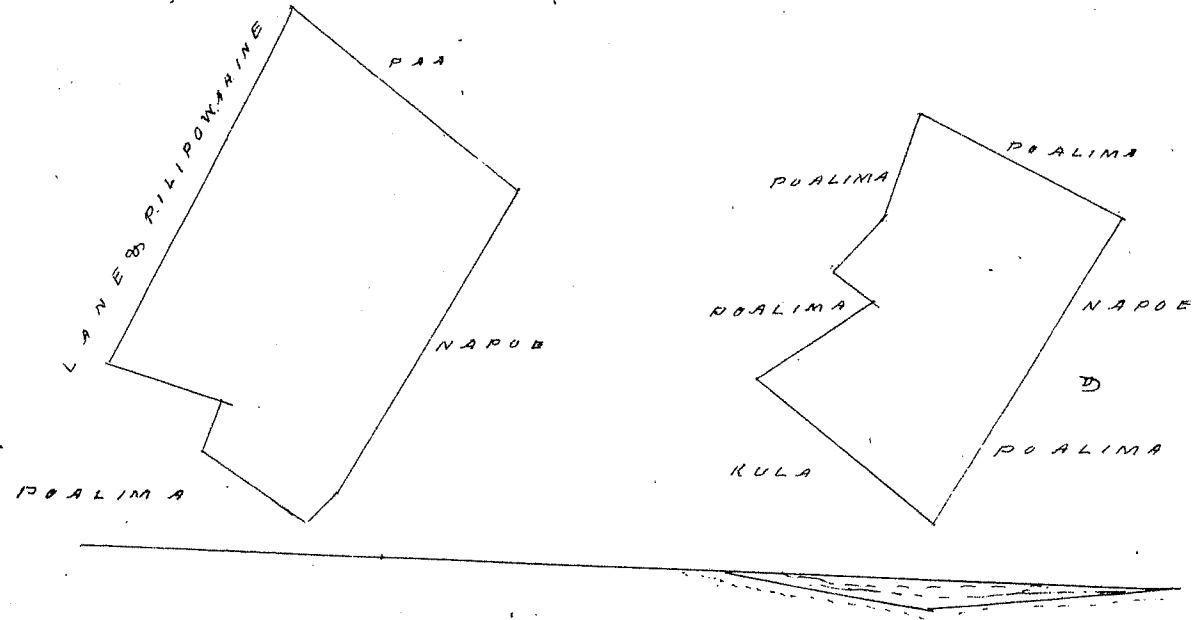

Uku Pau Loa # 6
W. L. Lee
G. M. Robertson
J. H. Kaulahas
J. H. Smith

Honolulu 27 Oct 1852

Hele 10469 Napae

Wailuku Maui

Mahele 1. Ahupuaa Poinonii, E hoomatika ke ana ma ke kiki Komohana e keia e pili ana one ke kiki
Akaui o Pu, Akaui 24 3/4; Hikina 157 Kaulahas ma ke Poalima, Hema 67 1/4; Hikina 190 Kaulahas ma
ke Kamahiai, Hema 19 1/4; Komohana 182 Kaulahas ma ke Poalima, Akaui 60 1/4; Komohana 210 Kaula
has ma ke Pu, a hiki ma kahi i hoomatika'i, a onalohe ia anapuni 33/100 Eka,

Mahele 11 Ahupuaa Poinonii, E hoomatika ke ana ma ke kiki Hikina, e pili ana one ke Poalima
Komohana poroi 35 Kaulahas, Hema 73 Komohana 61 Kaulahas ma ke Kamahiai, Akaui 79 1/4 Komohana 288
Kaulahas ma ke Kamahiai, Hema 39 Komohana 22 Kaulahas ma ke Paa, Hema 62 1/4; Hikina 366 Kaulahas
ma ke Pu, Akaui 22 1/4; Hikina 165 Kaulahas ma ke Poalima, a hiki ma kahi i hoomatika'i, a onalohe
ia anapuni, 3/10 Eka,

Wailuku, Aug 20, 1852.

John S. Lower
Mea ana aina

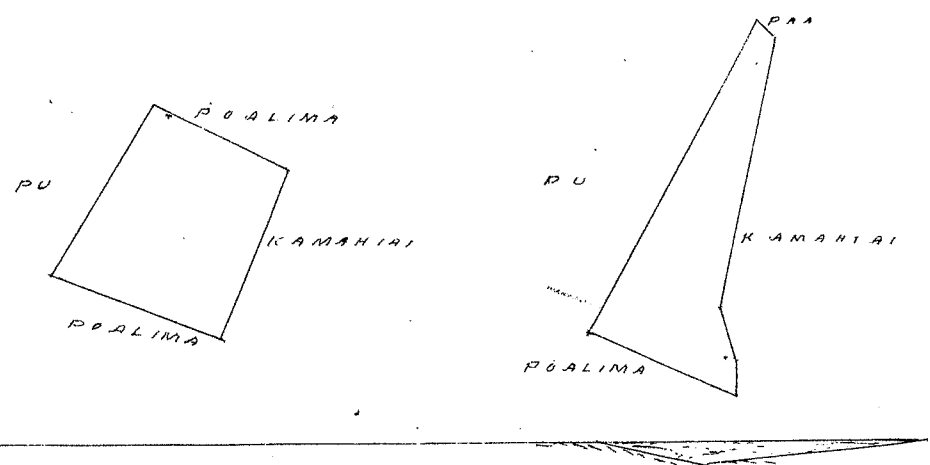

Uku Pau Loa # 4
W. L. Lee
G. M. Robertson
J. H. Kaulahas
J. H. Smith

Honolulu 27 October 1852

Heleu 2429 Kooliki 5459 V.

Hamakualoa Maui

Mahele 1. Ili Kuamoohua Honopuu E hoomaka ke ana ma ke kahi Hikiina o Keia
Akaui 13 1/2 Komohana 367 Kaulahas ma ke Kaulaha. Nema 35 Komohana 430 Kaulahas ma Kula,
Nema 13 1/2 Hikiina 367 Kaulahas ma Kula, Akaui 35 Hikiina 430 Kaulahas ma Kula, a hiki ma
Kahi i hoomaka'i, a maloko via anapuni 12/100 Eka.

Mahele 2 E hoomaka ke ana ma ke kahi Akaui o Keia, e pili ana me ke kahi
Nema 49 1/2 Komohana 335 Kaulahas ma Kula, Nema 35 1/4 Hikiina 425 Kaulahas ma Kula
Nema 79 1/4 Hikiina 359 Kaulahas ma Kula, Akaui 15 Komohana 364 Kaulahas ma Kula
Akaui 46 Komohana 370 Kaulahas ma Kula, a hiki ma Kahi i hoomaka'i, a maloko via
anapuni 14 1/100 Eka.

Wailuku Aug. 26, 1852.

John S. Cowie
Mea ana aina

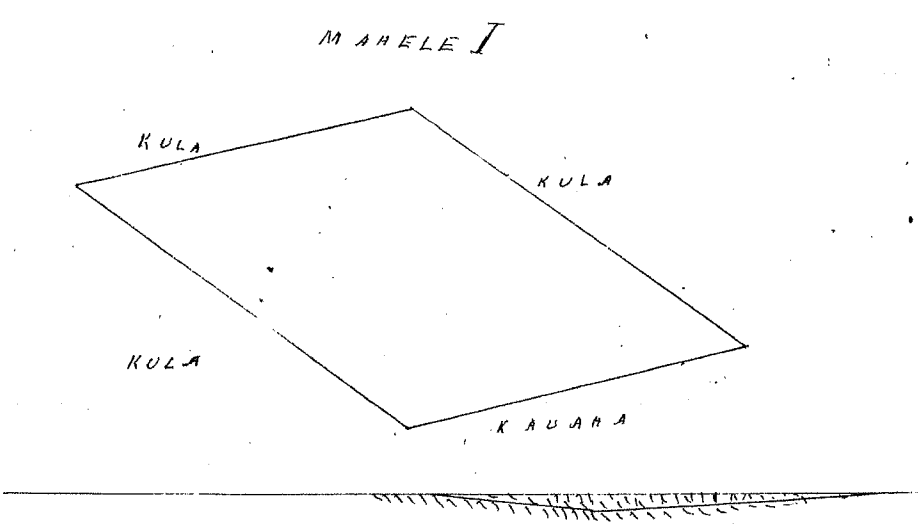
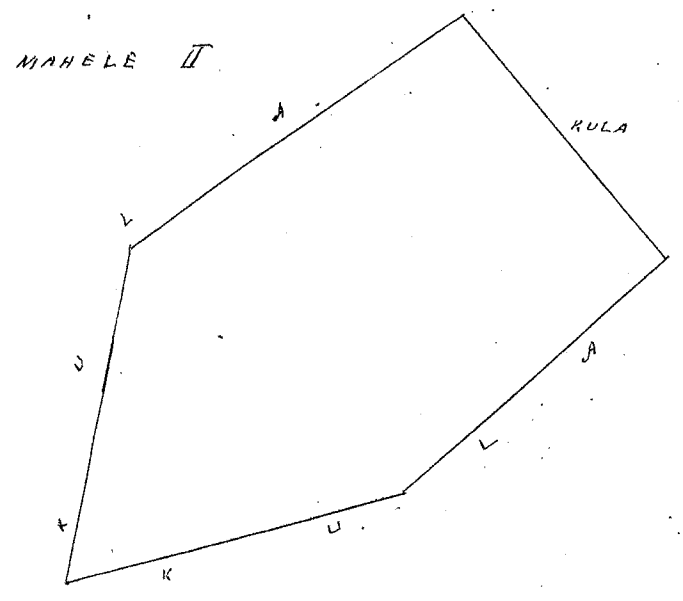

Uku Pau Loa #6
W. L. Lee
G. M. Robertson
J. Kaulahas
C. H. Smith

Honolulu 27 Oct 1852.

Heleu 3462 Kooloni

Waikuu Maui

Apapa 1. Ili Chianii, E hoomaka ke ana ma ke kahi Hikiina o Keia, e pili ana me ke kahi Nema o
Maui, Akaui 54 1/4 Komohana 853 Kaulahas ma ke Maui o Kula, Nema 62 1/2 Komohana 174 Kaulahas
ma ke Apapaui, Akaui 55 Komohana 64 Kaulahas ma ke Apapaui, Nema 35 Komohana 135 Kaulahas
ma ke Apapaui, Akaui 43 1/4 Komohana 173 Kaulahas ma ke Apapaui, Nema 59 1/4 Komohana 151
Kaulahas ma ke Keia, Nema 46 Hikiina 303 Kaulahas ma ke Kuaui, Nema 49 Hikiina 110 Kaulahas
ma ke Kuaui, Nema 50 Hikiina 512 Kaulahas ma ke Kuaui, Akaui 42 3/4 Hikiina 61 Kaulahas
ma ke Poalima Nema 41 3/4 Hikiina 168 Kaulahas ma ke Poalima, Akaui 51 1/2 Hikiina 479 Kk.
ma Kahawai, a hiki ma Kahi i hoomaka'i, a maloko via anapuni 13 1/100 Eka.

Poalima, E hoomaka ma ke kahi Hikiina o Keia, ma ke kahi Hikiina o Keia Kuleana,
Akaui 76 Kom. 450 Kaulahas, Nema 29 Kom 244 Kk. Akaui 44 Kom 93 Kk Akaui 38 1/2 Hiki 145
Kk, Nema 60 Hiki 23 Kk Akaui 44 1/4 Hiki 85 Kk, Nema 49 Hikiina 85 Kk a hiki ma
Kahi i hoomaka'i, a maloko via Poalima 12/100 Eka.

Apapa 11 Ua haele via
Wailuku, Aug. 12, 1852

John S. Cowie
Mea ana aina

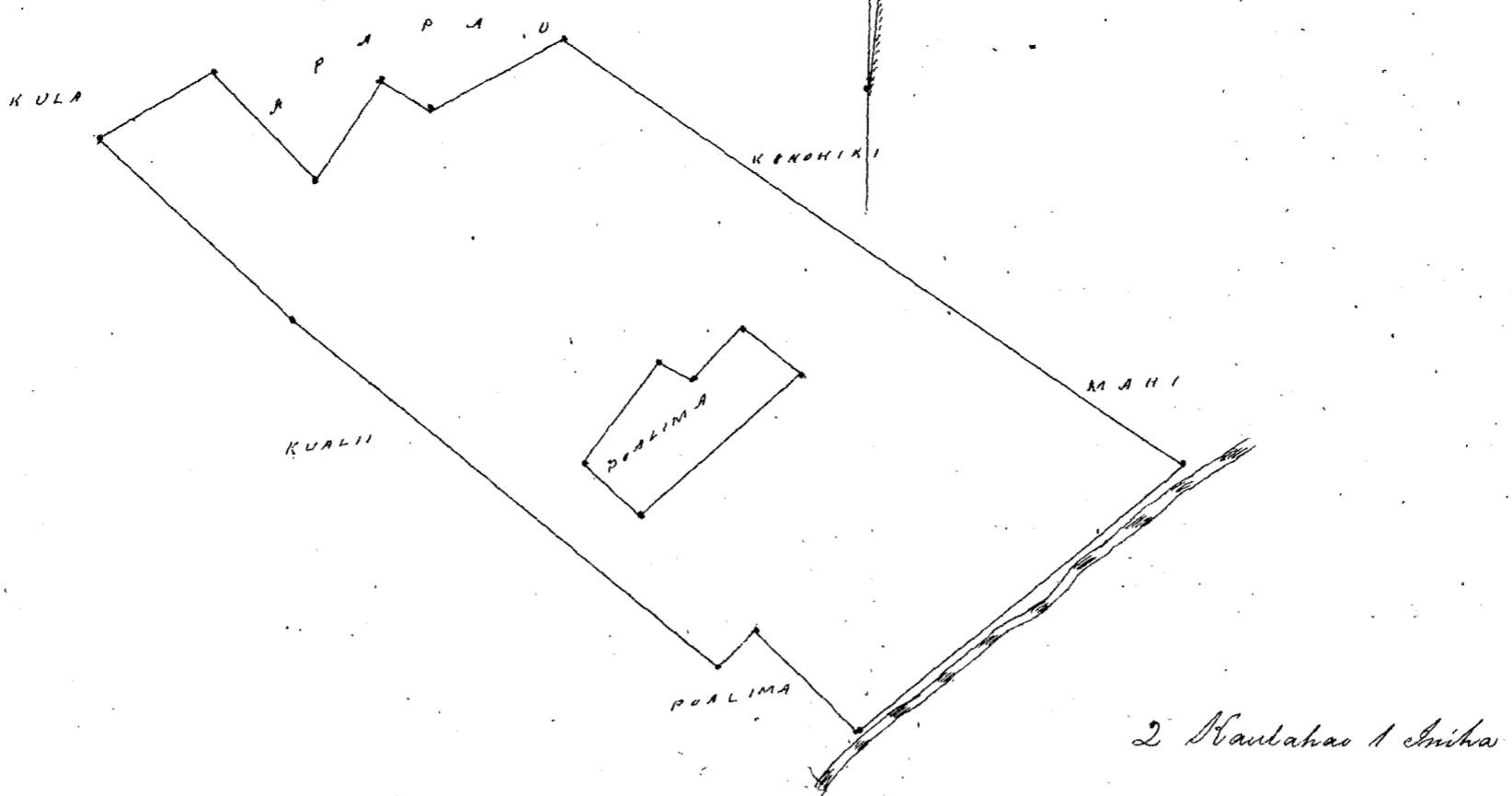

Whee Pau Loa / 7
 W. L. Lee
 G. M. Robertson
 J. H. Kaulahaos
 J. H. Smith

Honolulu 27 Oct 1852.

Heleu 2749. Nakaiahale / Kawailoa, Waialua Oahu

Mai 107 mwa, eases

Ke Nakaiahale Kuleana Kaimakole, ma Kawailoa kai, Waialua Oahu.
 E hoomaka ma ke kiki Nema o ke Hokuwaulani aima, a e holo i ka Akau 19° Komohana 2²⁵/₁₀₀ Haulahaos
 ma ke Hokuwaulani - a i ka Nema 71³/₄ Komohana 1¹⁵/₁₀₀ Haulahaos, ma ke Kealainanea, a hiki i ke ke
 Konoiki - alaila Nema 68° 30' Komohana 3³⁹/₁₀₀ Haulahaos, a one Nema, 11° Nihina 5⁴⁵/₁₀₀ Haulahaos ma ke
 aima o ke Konoiki, a hiki i ke Puwa, - a i ka Akau 64° 30' Nihina 1¹/₁₀₀ Haulahaos, ma ke Puwa, a hiki
 hou i ke kahi aima o ke Konoiki, - a i ka Akau 60° 30' Nihina 3¹³/₁₀₀ Haulahaos ma ke ke Konoiki, a
 hiki i ke Nahuwala, a i ka Akau 51° 30' Nihina 4⁵⁶/₁₀₀ Haulahaos ma ke Nahuwala, a hiki i ka Loke
 . Laanui lona me Gulick, - a i ka Akau 31° Komohana 1⁴⁰/₁₀₀ Haulahaos ma ia Loke, a hiki i ke Hoku-
 waulani kiki Akau kela aima, - alaila Nema 70° Komohana 1⁵/₁₀₀ Haulahaos ma ke Hokuwaulani, a hiki
 i ke Nahuwala, - a i ka Nema 19° Nihina 26 pautu, a one Nema 70° Komohana, ma ke
 Nahuwala, a one ke Hokuwaulani, a hiki ma kahi i hoomaka i

Maalo i keia Kuleana 3 Eka,

Waialua, 9. Iulai, 1852.

J. S. Emerson,
 Iana,
 Hooponoponi hou ia e S. P. Halama,
 ma ke Kaulahaos o ma Lona.

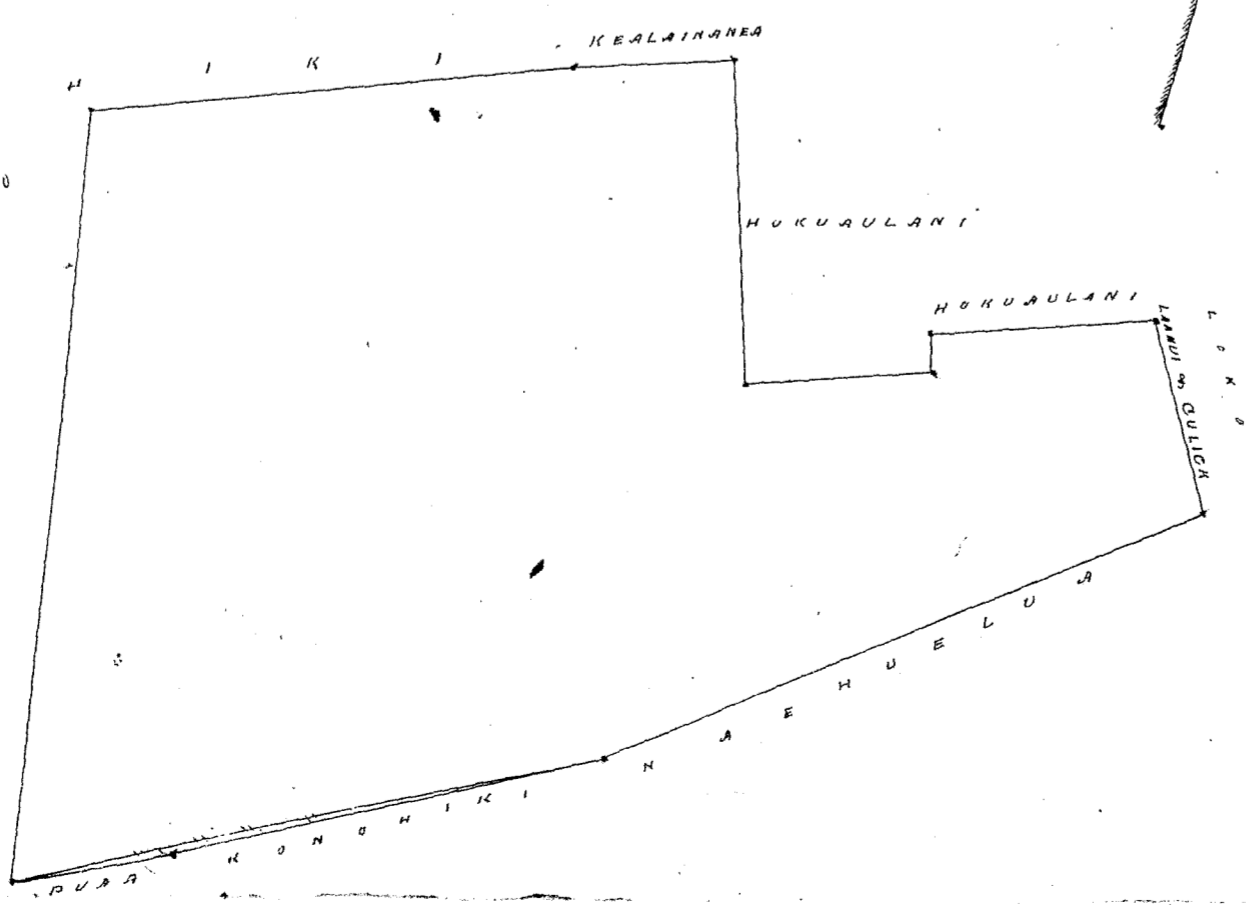

3/4 Iniba Haulahaos.

Uku Pau Loa / 5. 60

W. L. Lee
G. M. Robertson
J. Kakaiahia
J. H. Smith

Honolulu 20. Novemaba 1852.

Hulu 3435 Keaohula, Kaiehu Maui

Apana I D II Ili Kapalawa. E hirmaka ke ana ma ke kiki Akau o keia, e pili ana me ke kiki
Hikina o Kaili. Nema 46 1/2 Hikina 145 Kaulahao ma ke Poalima, Nema 48 Komohana 449 Kaula
hao ma ke Kanaina, Nema 24 Komohana 218 Kaulahao ma ke Kanaina, Nema 42 1/2 Komohana
303 Kaulahao ma ke Kanaina, Nema 53 Komohana 420 Kaulahao ma Kula, Akau 25 1/2 Kom
ohana 148 Kaulahao ma ke Poalima, Nema 69 Komohana 63 Kaulahao ma ke Poalima, Nema 25
Hikina 156 Kaulahao ma ke Poalima, Nema 59 Komohana 303 Kaulahao ma Kula,
Akau 5 3/4 Komohana 395 Kaulahao ma ke Apapau, Akau 59 1/2 Hikina 618 Kaulahao
ma ke Kaili, Nema 29 1/2 Hikina 126 Kaulahao ma ke Poalima, Akau 68 Hikina 46
Kaulahao ma Poalima, Nema 24 1/2 Hikina 75 Kaulahao ma ke Poalima, Akau 66 3/4 Hikina
65 Kaulahao ma ke Poalima, Akau 18 Komohana 207 Kaulahao ma ke Poalima, Akau 4 3/2
Hikina 254 Kaulahao ma ke Kaili Akau 50 1/2 Hikina 467 Kaulahao ma ke Kaili a kiki ma
Kahi i hirmaka'i a maloku via anapuni 3 8/10 Eka

Poalima E hirmaka ke ana ma ke kiki Komohana o keia mai ke kiki Komohana o keia
Kulama, Ak. 75 Hike 212 Kaulahao, Nema 35 3/4 Hike 94 Kaulahao, Ak. 63 1/4 Hike 80 Ak.
Ak. 24 Kom. 100 Kaulahao, Nema 58 Kom. 102 a kiki ma kahi i hirmaka'i a maloku via
Poalima 8/100 Eka

Apana III Ua hualala keia apana,
Wailuku July 25. 1852.

John S. Cowie
(Ma ana aina)

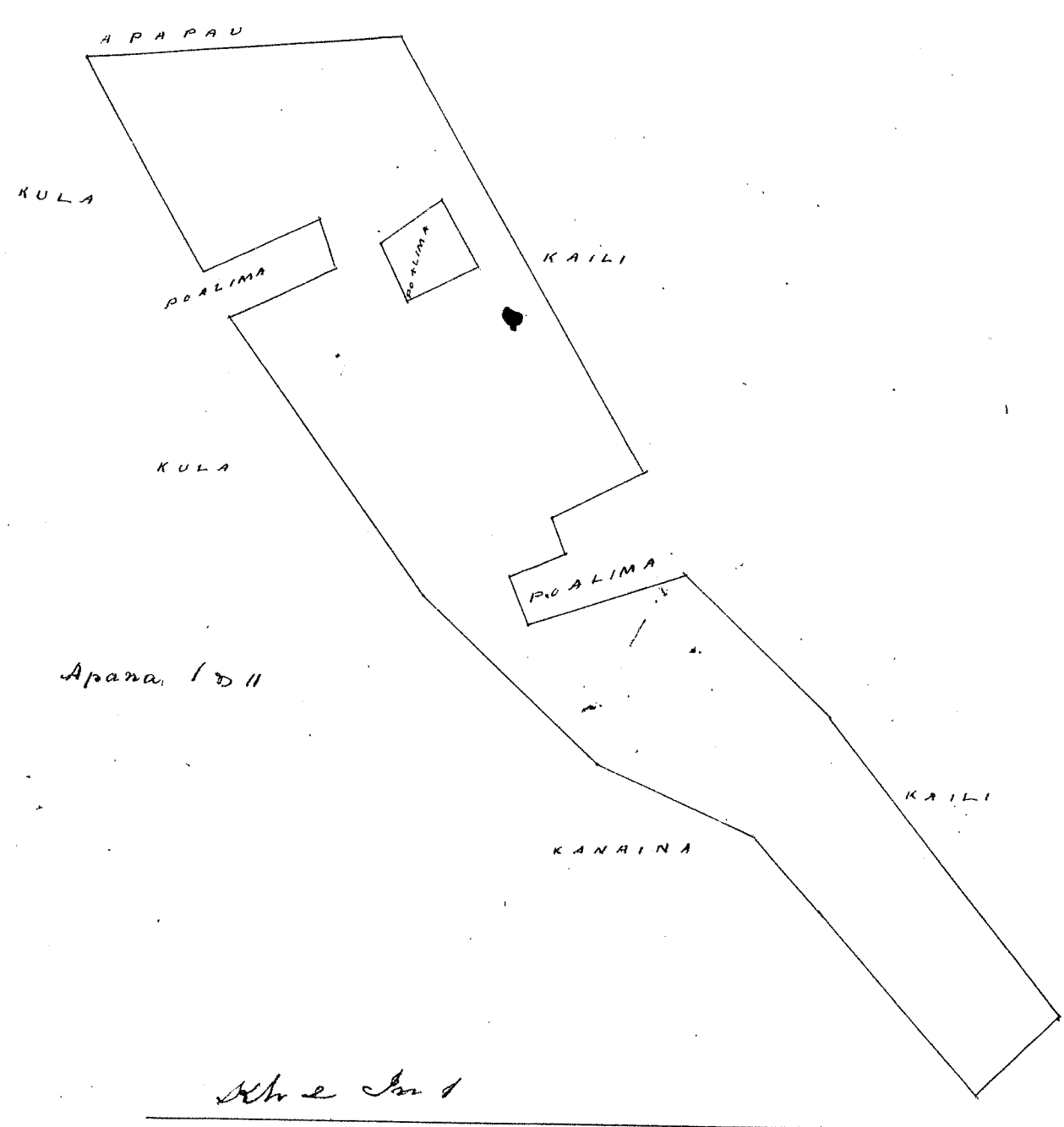

Uka Pau Loa \$ 7.

W. L. Lee
G. M. Robertson
S. Kekaulaha
J. H. Smith

Honolulu 27 Oct 1852.

Kulu 5515 Pihupiku

Hamakua Maui

Apana 1^o 11 Ili Kaloko & Kahalo - Peahi. E hoomaka ke ana ma ke kahi Komohana Akau o Keia. Nema 1^o Hikiina 161 Kaulahas ma ka Poalima, Nema 46 1/2 Komohana 141 Kaulahas ma ka Poalima Nema 1^o Hikiina 503 Kaulahas ma ka Pali, Akau 86 1/4 Hikiina 440 Kaulahas, ma ka Pali, Akau 59 Komohana 325 Kaulahas ma Keiwa, Akau 46 Hikiina 183 Kaulahas ma ka Kawahi, Akau 4 3/4 Komohana 150 Kaulahas ma ke kahi kela aas, Akau 23 3/4 Hikiina 338 Kaulahas ma ka Pali, Nema 86 1/2 Komohana 321 Kaulahas ma Kahawai, a hiki ma kahi i hoomaka i, a maloko via anapuni, 188/100 Eka

Poalima, E hoomaka ke ana ma ke kahi Nema o Keia, (Ma ke pahu e ono o Keia Kuleana, Akau 27 Komohana 78 Kaulahas, Akau 40 1/2 Komohana 85 Kaulahas, Akau 40 3/4 Hikiina 58 Kaulahas, Akau 40 1/2 Hikiina 85 Kaulahas, Nema 40 3/4 Komohana 58 Kaulahas Kaulahas a hiki ma kahi i hoomaka i, a maloko via anapuni, 5/100 Eka.

Apana III & IIII Aole Loa via

Wailuku, Sept. 6, 1852.

John S. Lowers,
Ma ana aina

APANA I & II

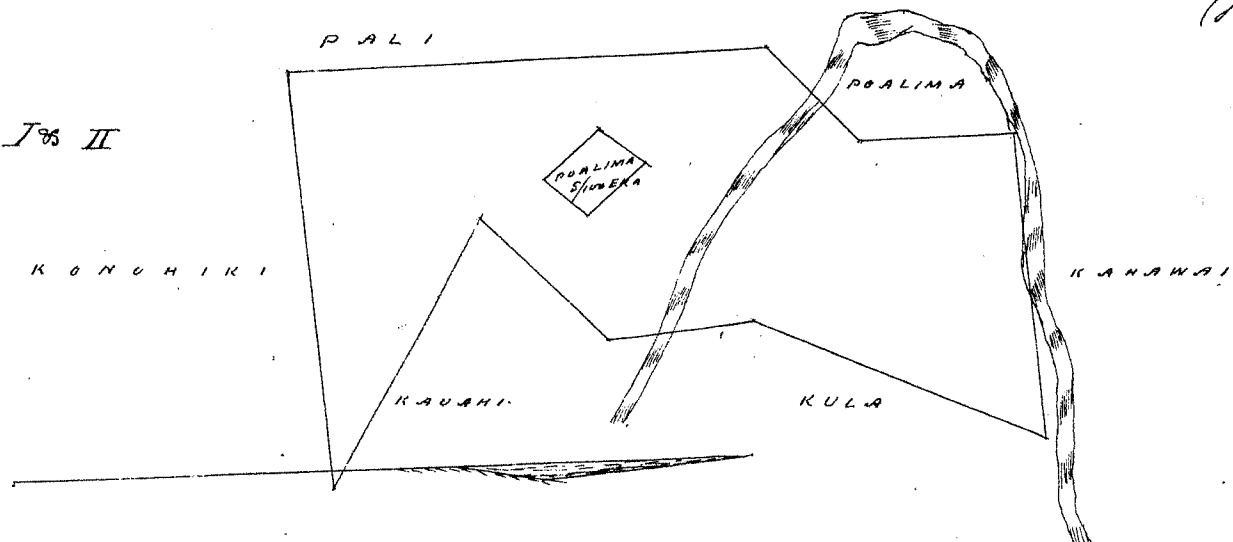

Uka Pau Loa \$ 6

W. L. Lee
G. M. Robertson
S. Kekaulaha
J. H. Smith

Honolulu 27 Oct 1852

Kulu 5459 Kamauu

Hamakua Maui

Apana 1. Ili Pohakuloa, Waipio, E hoomaka ke ana ma ke kahi Komohana Akau o Keia, Nema 82 1/2 Hikiina 346 Kaulahas ma ka pali, Nema 25 Komohana 430 Kaulahas ma ka pali, Nema 27 1/4 Komohana 223 Kaulahas ma ka pali, Akau 13 Hikiina 477 Kaulahas ma ka Pali, Akau 44 Komohana 244 Kaulahas ma ka Auwai, a hiki ma kahi i hoomaka i, a maloko via anapuni 6/100 Eka.

Apana 2. Waipio, E hoomaka ke ana ma ke kahi Nema o Keia e pili ana ma ka Poalima, Akau 3 1/2 Komohana 372 Kaulahas ma ka Auwai, Akau 49 Komohana 147 Kaulahas ma kela aas o ka auwai, Nema 13 1/2 Hikiina 478 Kaulahas ma ka pali & Poalima, a hiki ma kahi i hoomaka i, a maloko via anapuni, 2/100 Eka.

Apana 3. Ua mati ole, aole ana
Apana 4. Olana i uka loa, aole ana.

Wailuku, Aug. 13, 1852

John S. Lowers,
Ma ana aina

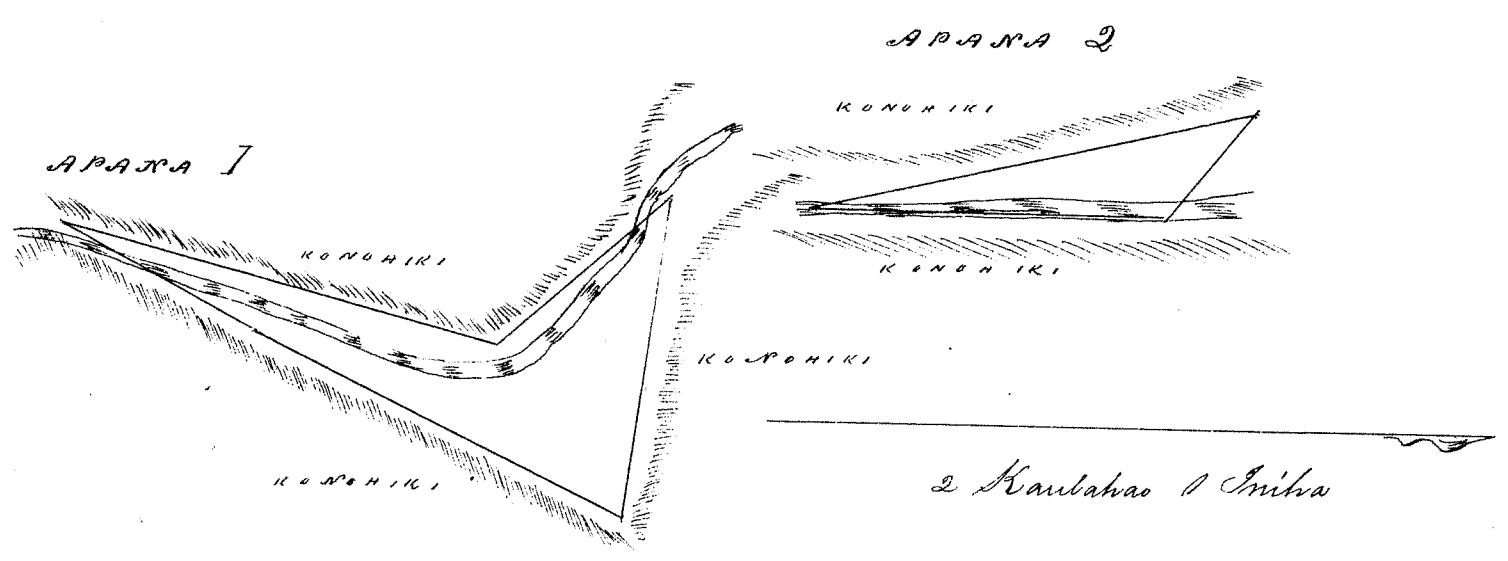

Uku Pau Loa p. 4
 W. L. Lee
 G. M. Robertson
 J. K. Kaulahao
 J. N. Smith

Honolulu 27 Oct 1852

Kulu 2542 ~~3542~~ Ulaula

belonging to Ahikini (belonging to)
 Kaulahao Maui

Mahele I Ili Kuumatwale. E hoomaka ke ana ma ke kiki Iikina. keia, Akau $34\frac{3}{4}$ Komohana 180 Kaulahao ma ke Poalima, Heima $62\frac{3}{4}$ Komohana 70 Kaulahao ma ke Poalima, Akau $32\frac{1}{2}$ Komohana 57 Kaulahao ma ke Poalima, Heima 56, Komohana 87 Kaulahao ma ke Konohiki, Heima $27\frac{1}{4}$ Heikina 77 Kaulahao ma ke Konohiki, Akau $65\frac{3}{4}$ Heikina 84 Kaulahao ma ke Poalima, Heima $38\frac{1}{4}$ Heikina 145 Kaulahao ma ke Poalima, Akau $62\frac{1}{2}$ Heikina 76 Kaulahao ma ke Poalima, a hiki ma kahi i hoomaka i a maloko via anapuni, 22/100 Eka,

Mahele II Ili Kuumatwale. E hoomaka ke ana mai ke kiki Heima. Mahele I Heima $66\frac{1}{2}$ Komohana 293 Kaulahao. Ahiki ma ke kiki Iikina. keia, Akau 25 Komohana 78 Kaulahao ma ke Poalima, Heima $61\frac{1}{2}$ Komohana 265 Kaulahao ma ke Poalima, Akau 25 Komohana 160 Kaulahao ma ke Poalima, Heima $62\frac{3}{4}$ Komohana 240 Kaulahao ma ke Konohiki, Heima $31\frac{1}{4}$ Heikina 80 Kaulahao ma ke Konohiki, Akau 64 Heikina 118 Kaulahao ma ke Poalima, Heima $49\frac{1}{4}$ Heikina 99 Kaulahao ma ke Poalima, Akau $61\frac{1}{4}$ Heikina 351 Kaulahao ma ke Poalima, a hiki ma kahi i hoomaka i a maloko via anapuni, 5/100 Eka,

Wailuku, Aug. 12, 1852

John S. Low
 (Maui ana aia)

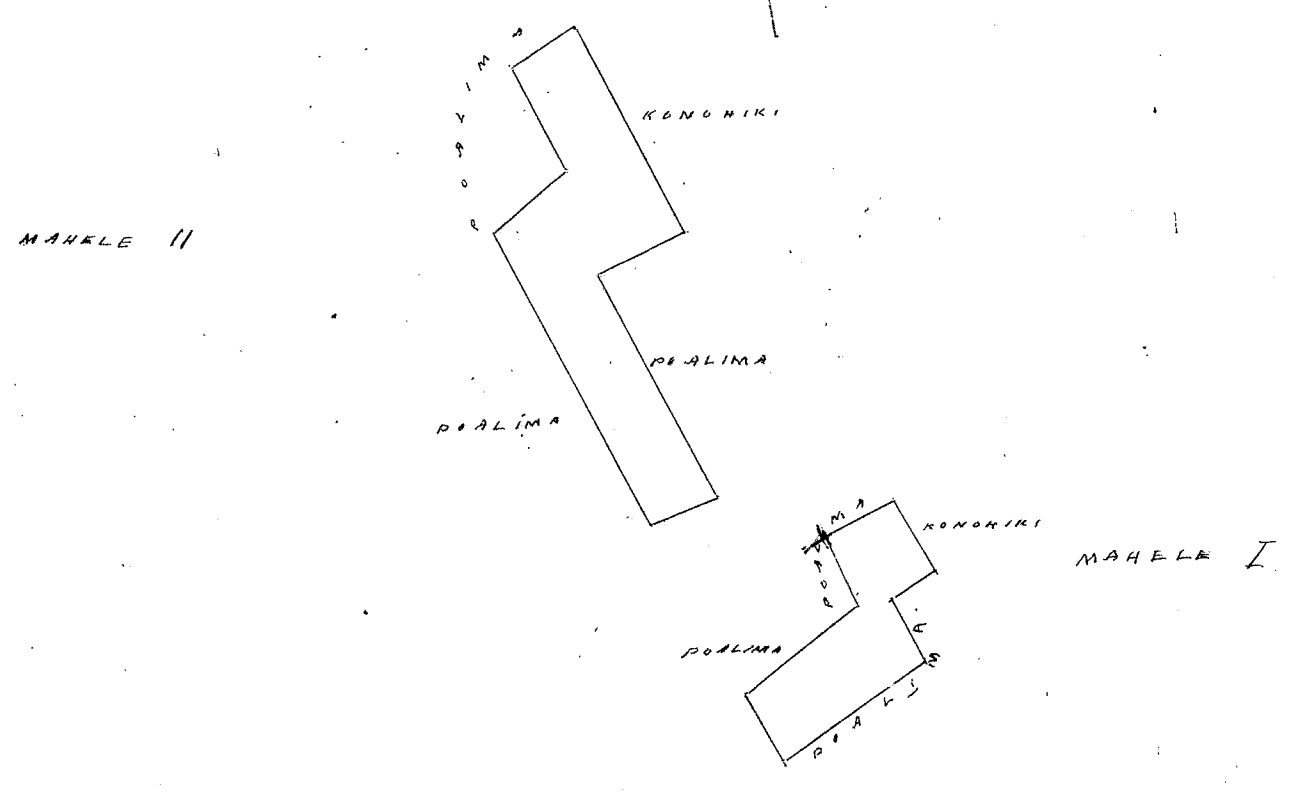

Uku Pau Loa # 4
W. L. Lee
G. M. Robertson
J. Kaulahao
J. H. Smith

Honolulu 27 Oct 1852

Hulu 24 33 Kahikapa

Waiau Maui

Aprana 1. Ili Kuhuana. Chomaka ke ana ma ke kiki Komohana o keia. Epili ana me Birch.
Aka 38. Hikiina 164 Kaulahao ma ke Birch, Hema 16 1/2. Hikiina 98 Kaulahao ma ka Poalima
Aka 43 Hikiina 34 Kaulahao ma ka Poalima, Aka 47 1/2. Komohana 1.00 Kaulahao ma ka Poalima
Aka 39 Hikiina 132 Kaulahao ma Kauhawai & Miner ke Birch, Aka 8 1/2. Hikiina 387 Kaulahao
ma Kauhawai & Miner, Hema. 66. Hikiina 244 Kaulahao ma Kauhawai & Miner, Hema 16 1/2 Komoha
na 186 Kaulahao ma Kauhawai & Miner, Hema 7. Komohana 166 Kaulahao ma ke Kauhawai & Miner,
Hema 55 Komohana 146 Kaulahao ma Kauhawai & Miner, Aka 55. Komohana 233 Kaulahao ma
ke Pauanihi, Aka 7 1/2. Hikiina 211 Kaulahao ma Kuba, Aka 65 Komohana 410 Kaulahao ma
Kuba, a hiki ma kahi i hoomaka i, a maloko via ana puni 4.5/100 Eka,

Poalima. Chomaka ke ana ma ke kiki Hikiina o keia, ma ke kiki Hikiina o keia Kuluana,
Hema 23 1/2. Komohana 154 Kaulahao Aka 53. Komohana 145 Kaulahao, Hema 19. Komohana 224
Kaulahao Hema 53. Hikiina 145 Kaulahao Aka 19. Hikiina 224 Kaulahao a hiki ma kahi i
hoomaka i, a maloko via Poalima, 31/100 Eka,

Aprana 11 Iloko o ke Kuluana o Pepeiao, Wa ae o Kahikapa
Aprana 111 Iloko o ke Kuluana o Maakamui, Wa ae o Kahikapa

Wailuku Aug 12, 1852

John S. Lowes
Mea ana aima

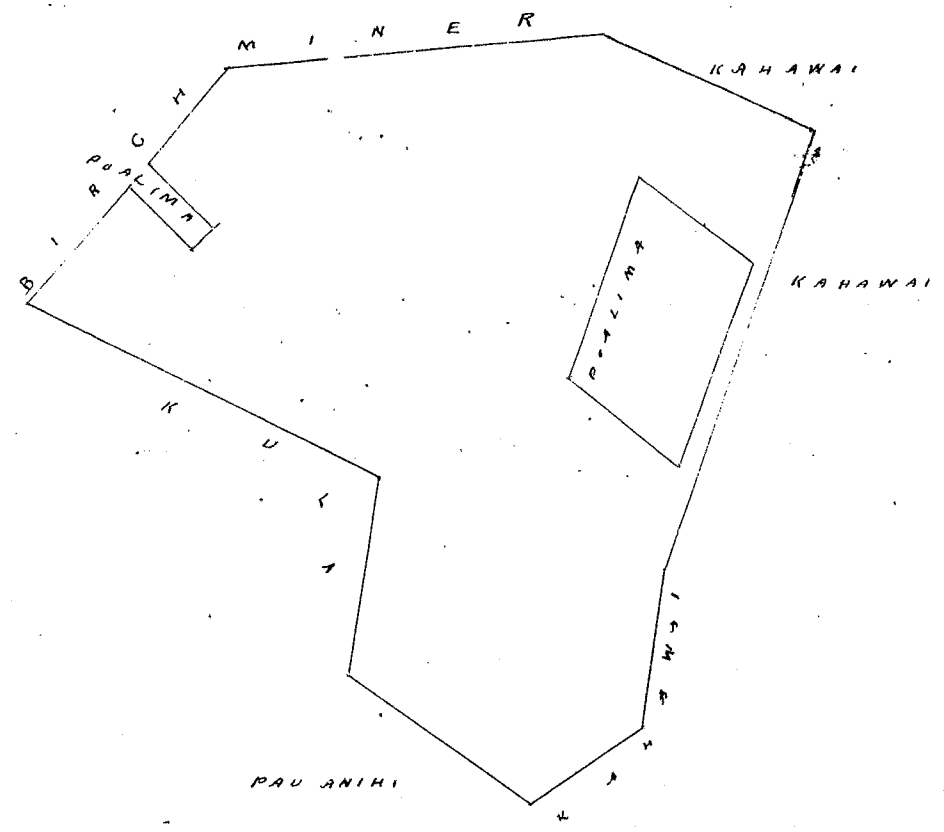

Uku Pau Loa # 7

W. L. Lee
G. M. Robertson
J. H. Smith

Honolulu 27 October 1852

Kele 3460 Kaia

Kaiahu Maui

Apana I. Ili Kapuho E hoomaka ke ana ona ke kiki Hikina o Keia, e pili ana me ke kiki Niwa o Puulau, Akau 21 3/4 Komohana 110 Kaulahas ma ke Puulau, Akau 76 Komohana 71 Kaulahas ma ke Poalima a Akau 21 3/4 Komohana 100 Kaulahas ma ke Poalima Niwa 76 Komohana 71 Kaulahas ma ke Poalima, Akau 21 3/4 Komohana 188 Kaulahas ma ke Puulau, Akau 45 Komohana 271 Kaulahas ma ke Puulau, Akau 67 Komohana 143 Kaulahas ma Puulau, Niwa 45 Komohana 60 Kaulahas ma ke Poalima Akau 64 Komohana 45 Kaulahas ma ke Poalima, Akau 45 Komohana 60 Kaulahas ma ke Poalima Akau 64 Komohana 87 Kaulahas ma Puulau, Niwa 45 1/2 Komohana 100 Kaulahas ma ke Puulau, Niwa 44 3/4 Komohana 203 Kaulahas ma ke Naopu, Niwa 26 Komohana 416 Kaulahas ma ke Naopu, Niwa 76 Komohana 98 Kaulahas ma Kahawai, Akau 5 Komohana 125 Kaulahas ma ke Poalima Niwa 76 Komohana 43 Kaulahas ma ke Poalima, Niwa 5 Komohana 125 Kaulahas ma ke Poalima Niwa 76 Komohana 206 Kaulahas ma Kahawai, a hiki ma kahi i hoomaka i, a maloke via anepuni 164/100 Eka.

Apana II Ili Kaulaitiki, e hoomaka ke ana ona ke kiki Hikina o Keia, e pili ana me ke kiki Niwa o Kuli, Akau 7 Komohana 9 Kaulahas ma ke Kuli, Niwa 85 Komohana 100 Kaulahas ma ke Poalima, Akau 7 Komohana 70 Kaulahas ma ke Poalima, Akau 85 Komohana 100 Kaulahas ma ke Poalima, Akau 7 Komohana 82 Kaulahas ma ke Kuli, Niwa 52 Komohana 156 Kk. ma ke Naopu, Akau 85 Kom 290 Kk. ma ke Naopu, Niwa 38 1/4 Kom 116 Kk. ma ke Naopu, Niwa 2 1/2 Kom 155 Kk. ma ke Naopu, Ak. 83 Hiki 5.27 Kk. ma ke Naopu a hiki ma kahi i hoomaka i, a maloke via anepuni, 94/100 Eka.

Wailuku, Aug. 23, 1852

John S. Cowie
Oma ana aina

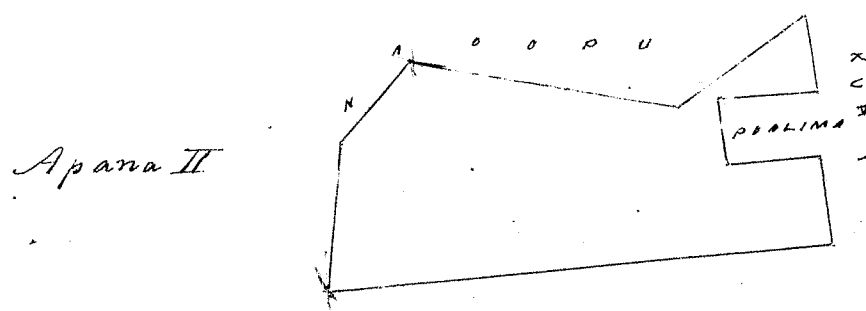
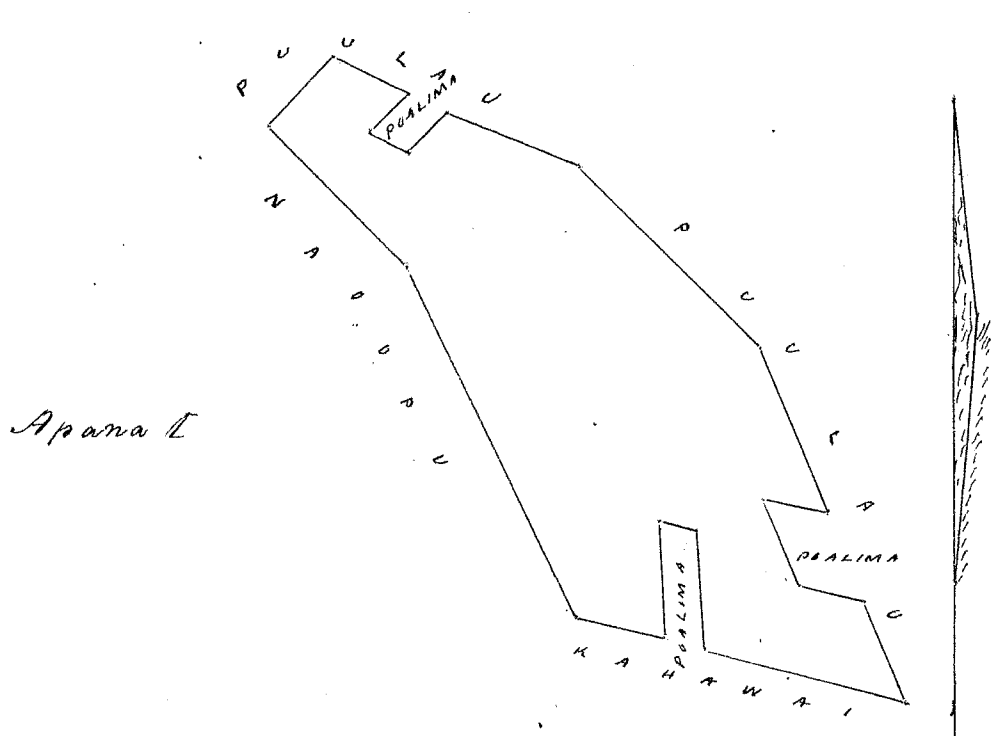

2 Kaul. 1 In.

Wku Pau Lea # 6
 W. L. Lee
 G. M. Robertson
 J. Kekaulahas
 J. H. Smith

Honolulu, 27, Oct. 1852

Hulu 2554 Wawa. ✓

Waiehu Maui

Apana I. Ili Hanohano. E hoomaka ke ana ma ke kiki Kuma o Keia, e pili ana me na Kaleo
 Akau $16\frac{3}{4}$ °. Heikina 5,88 Kaulahas ma ka Pali, Kuma $82\frac{1}{2}$ °. Komohana 101 Kaulahas ma ka Kamahiau
 Akau $11\frac{1}{2}$ °. Heikina 36 Kaulahas ma ke Kamahiau, Kuma $82\frac{3}{4}$ °. Komohana 79 Kaulahas ma ke Kamahiau
 Kuma $1\frac{3}{4}$ °. Heikina 5,64 Kaulahas ma ke Kaleo, a hiki ma kaahi i hoomaka'i, a maatki oia anapuni
 $\frac{1}{2}$ Eka.

Apana II & III Ili Hanohano. E hoomaka ke ana ma ke kiki Komohana o Keia, e pili ana me
 ke kiki Akau o Kamahiau, Akau 41 Heikina 114 Kaulahas ma Kahawai, Kuma 67 Heikina 32 Kaulahas
 ma ka Poalima, Kuma $18\frac{3}{4}$ °. Kom 55 Ak. ma ka Poalima, Kuma $68\frac{3}{4}$ °. Heik 87 Kaul. ma ka Poalima,
 Akau $22\frac{1}{4}$ °. Heik 50 Kaul. ma ka Poalima, Kuma $60\frac{3}{4}$ °. Heik. 69 Kaul. Ak. $32\frac{1}{2}$ Heikina 1,38 Ak.
 Ak 6: Heik 64 Kaul. ma Makalawelawe, Ak 28 Heik 128 Kaul ma ke Keawe, Ak. $66\frac{3}{4}$ °. Kom. 74
 Kaul. ma ke Keawe, Kuma 33 Kom 121 Kaul. ma ke Keawe, Ak. 61 Kom. 147 Kaul. ma Makalawelawe
 Kuma 37° Kom 76 Kaul. ma ke Makalawelawe, Ak. $16\frac{1}{4}$ °. Heik 89 Kaul. ma Kahawai, Ak $60\frac{3}{4}$ °.
 Heik 465 Kaul. ma Kahawai, Kuma 7° Heik 83 Kaul. ma ka Pali, Kuma $13\frac{3}{4}$ Kom, 628 Kaul. ma ka
 Pali, Ak. $67\frac{1}{4}$ Kom 466 Kaul. ma ka Kamahiau, a hiki ma kaahi i hoomaka'i, a maatki oia
 anapuni, $1,38\frac{1}{100}$ Eka.

John S. Lower,
 Mea ana aina

Kailuku, Aug 20, 1852.

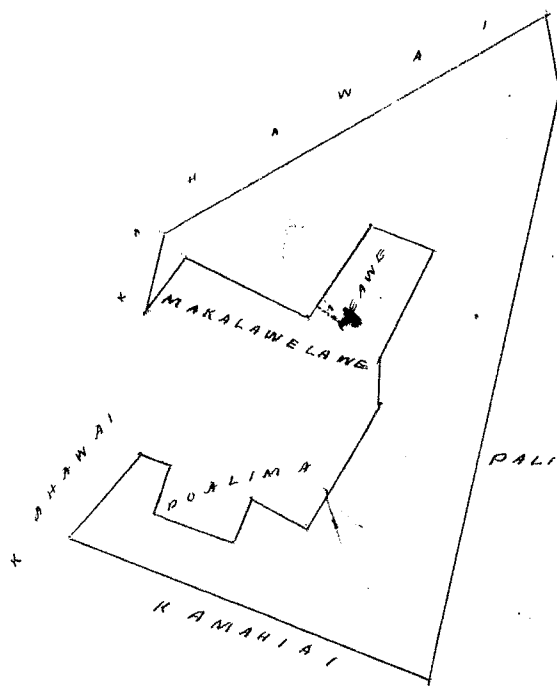

Apana II & III

Apana I

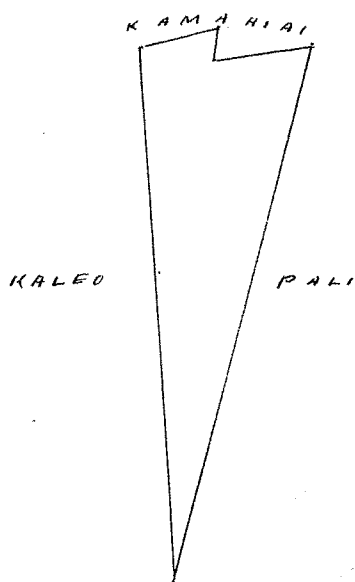

Sh 2. In 1.

Uku Pau Loa / 6

- W. L. Lee
- G. M. Robertson
- S. Kekaulahas
- J. H. Smith

Honolulu, 27. Oct. 1852.

Keolu 3452 Kaula

Waikuu Maui

Mahale I. Ili Kaula. E hoomaka ke ana ma ke kahi Hikiina o Kaulapahi. o ke kahi Akau o keia, Hema 47 Komohana 275 Kaul. ma ke Kaulapahi; Hema 56 Kom 286 Akh, Hema 54 Kom. 160 Kaul. ma ke Kaulapahi; Hema 33 Hiki 141 Kaul. ma Poalima Akh. 43 1/2 Hiki, 254 Kaul ma ke Kioohula, Akh. 50 1/2 Hiki, 467 Kaul. ma Kioohula, Akh. 25 Kom. 89 Kaul. ma Kahaikaha, a hiki ma kahi i hoomaka i

Mahale II Ili Kaula. E hoomaka ke ana ma ke kahi Komohana o keia, e pili ana ma ke kahi Komohana Hema o Kaulapahi, Hema 14 Hikiina 183 Kaulahas ma ke Poalima, Akau 59 1/2 Hikiina 668 Kaulahas, ma ke Kioohula, Akau 43 Komohana 127 Kaulahas ma ke Poalima, Hema 59 3/4 Komohana 568 Kaulahas ma ke Kaulapahi, Akau 84 1/2 Komohana 80 Kaulahas ma ke Kaulapahi, a hiki ma kahi i hoomaka i a maloko oia ma anapuni eua 1. 46/100 Eka,

Wailuku, Aug. 12, 1852

John S. Cowie
Mea ana aina.

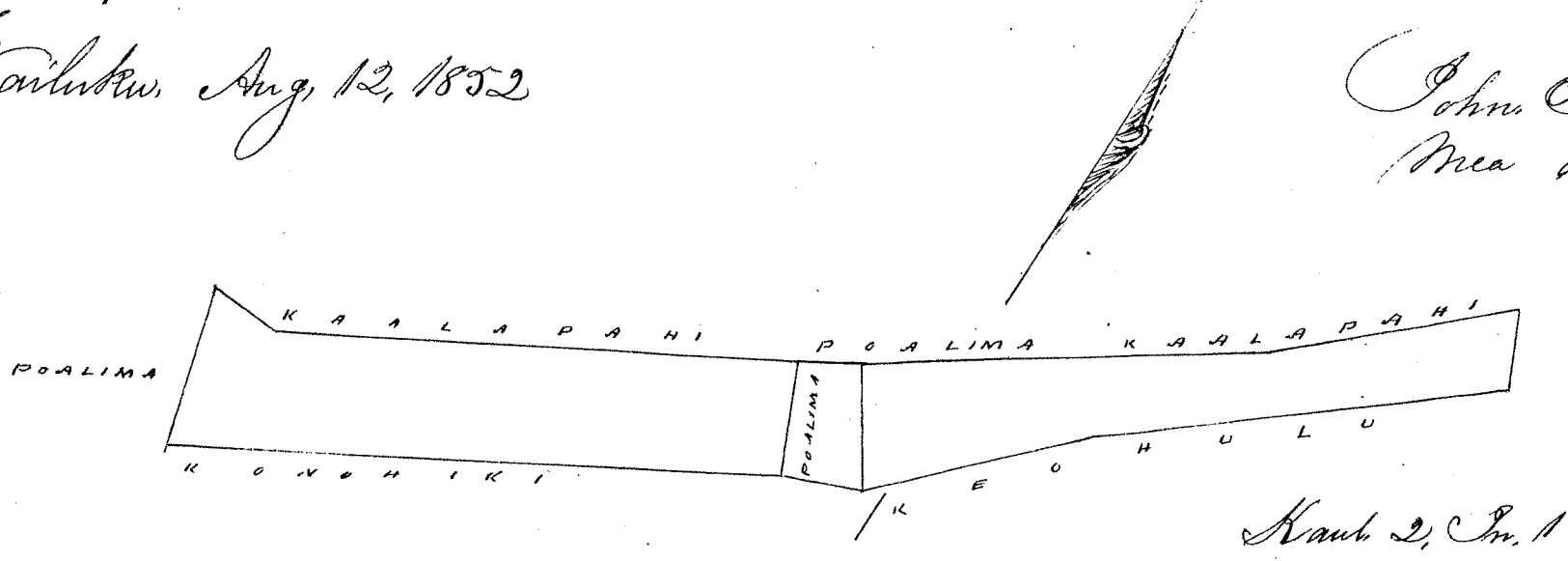

- Wm. Pau Lee
- W. L. Lee
- G. M. Robertson
- J. Kaulahas
- J. H. Smith

Konohiki 27 Oct 1852

Keolu 8365 Kaula

See 6157 Waiee Maui

Apana V Ili o Papaina. E hoomaka ke ana ma ke kahi Hema o Lupaahulu, Apana II Akau 25 1/2 Kom. 10 Kaul. Lupaahulu, Hema 60 3/4 Kom. 203 Kaul. Keapu, Hema 32 Hiki 195 Kaul. Keoli o Poalima, Akh. 51 1/2 Hiki, 217 Kaul. Konohiki, Akh. 39 Kom 113 Kaul. ma Konohiki, a hiki ma kahi i hoomaka i, a maloko oia anapuni; 36/100 Eka.

Apana III Ili Kapoho. E hoomaka ke ana ma ke kahi Hema o Kawainui, Akh 78 3/4 Hiki 243 Kh. Kawainui, Akh. 76 1/2 Hiki, 419 Kh. Konohiki Hema 15 Hiki, 97 Kh Hema 76 1/2 Kom. 419 Kh. Konohiki o Kekaala, Hema 16 Hiki 177 Kh. Konohiki o Kekaala, Akh. 88 Kom. 283 Kh. Konohiki, Akh. 4 3/4 Kom. 212 Kh. ma Konohiki, a hiki ma kahi i hoomaka i, a maloko oia anapuni; 15/100 Eka.

Wailuku, July 10, 1852

John S. Cowie
Mea ana aina

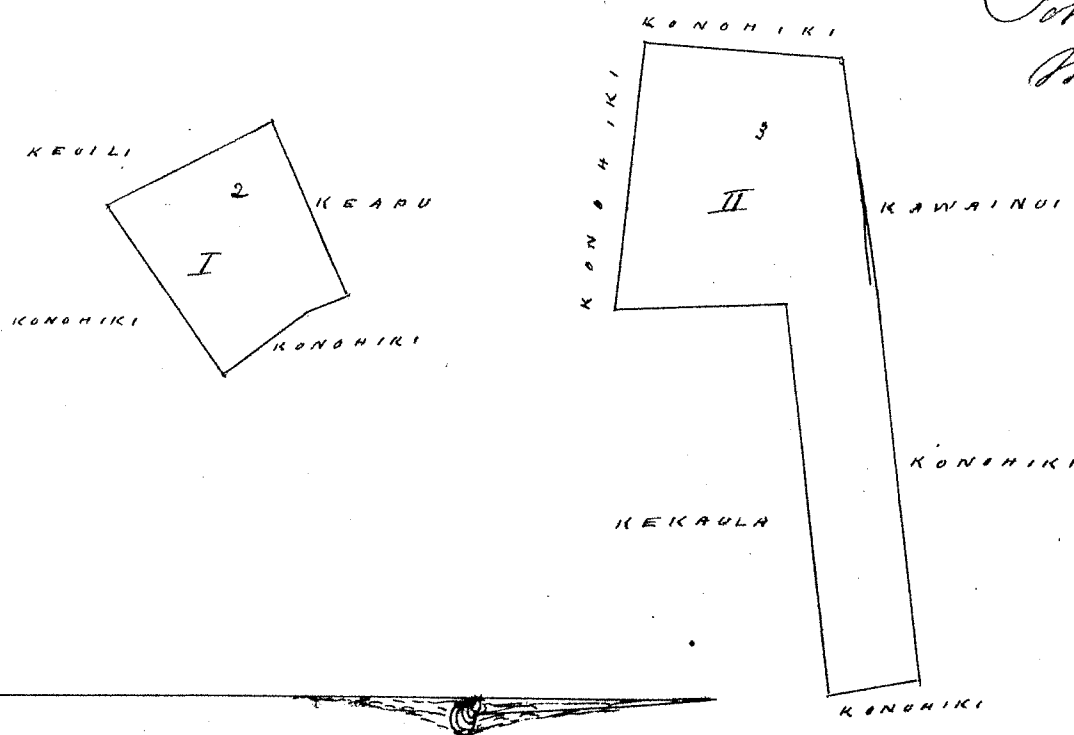

Uku Pau Lea \$5.

W. L. Lee
G. M. Robertson
W. Smith
J. Kekaulaha

Honolulu 27. Oct. 1852

Kelu 3492 & 5495 Kopea

Kaiehu Maui.

Apawa I. Ili Katalau. E hoomaka ke ana ma ke kiki Komohana o keia, e pili ana me Ehu. Hem 26 3/4; Hiki 35 Kh. Ehu. Hem. 22 1/2 Kom. 52 Kh. Ehu. Ak. 76; Hiki. 380 Kh. Ehu. Akau 56 1/4. Hiki. 109 Kh. ma Ehu. Ak. 27 1/4. Kom. 116 Kh. Poalima, Hem. 71. Kom 412 Kh. Waiwai. Hem. 15. Kom. 44 Kh. Waiwai, a hiki ma kahi i hoomaka'i, a maloko oia anapuni, 55/100 Eka.

Apawa II & III Oia Aalele oia.

Apawa III Ili Kapatana E hoomaka ke ana ma ke kiki Komohana o keia, e pili ana me ka auwai, Hem. 62 1/4. Hiki, 273 Kh. Auwai, Ak. 52 1/2, Hiki, 314 Kh. Auwai, Ak. 62 1/4, Hiki 273 Kh. ma Kula, Hem. 52 1/2. Kom. 314 Kh. ma Kula, a hiki ma kahi i hoomaka'i, a maloko oia anapuni 79/100 Eka.

Wailuku, Aug 13, 1852

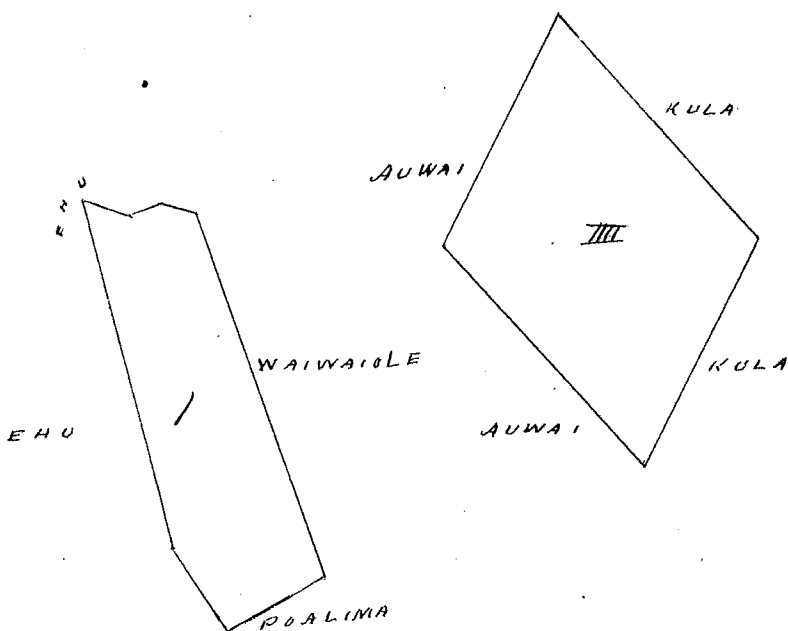

John S. Gurr
Mea ana aina

2 Kaul 1 Iiha

Uku Pau Lea \$6

W. L. Lee
G. M. Robertson
J. Kekaulaha
W. Smith

Honolulu 27 Oct 1852

Kelu 3510 Kaakina

Waihee Maui

Apawa I. Ili Papaina. E hoomaka ke ana ma ke kiki Akau o keia, e pili ana me ke kiki Komohana o Kwahu, Hem 34 1/2. Hiki 99 Kaul. ma Kwahu, Hem. 49 1/2. Hiki 135 Kaul. ma Konohiki, Ak. 48 1/4. Hiki 28 Kaul. ma Konohiki, Akau 58 1/2. Hiki 70 Kaul. ma Konohiki, Hem 36 1/4. Hiki, 308 Kaul. ma Poalima. Ak. 76 1/2. Kom. 148 Kaul. ma Auwai, Akau 41. Hiki 44 Kaul. ma Poalima, Ak. 39. Kom. 75 Kaul. ma Poalima, Hem. 50 Kom. 88 Kaul. ma Poalima. Ak. 66 1/4. Kom. 214 Kaulaha ma Auwai, Ak. 42 Hiki, 76 Kaul. ma Poalima, Ak. 53 Kom. 96 Kaul. ma Poalima, Hem. 28 1/4. Hiki 90 Kaul. ma Ka Auwai, a hiki ma ka pahu ma, a maloko oia anapuni, 48/100 Eka.

Apawa II Ili Papaina. E hoomaka ke ana ma ke kiki Komohana o Wahalua, Hem 72. Hiki 166 Kaul. ma Wahalua, Ak. 24 1/4. Kom. 59 Kaul. ma Wahalua, Hem. 72 Kom. 166 Kaul. ma Pali, Hem. 24 1/2. Hiki. 59. Kaul. ma Akihua a hiki ma ka pahu ma, a maloko oia anapuni, 7/10 Eka.

Apawa III Ili Ohia. Wa ai no Kaakina, hoomaka keia i loko o ke Kuluana o Hale.
Apawa III Ili Ohia Wa onahi ole.

Wailuku, July 7, 1852

John S. Gurr
Mea ana aina

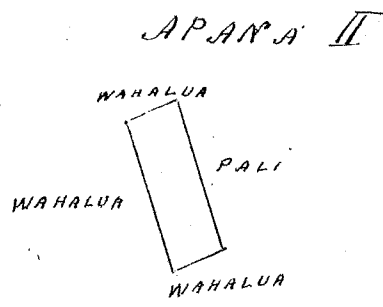
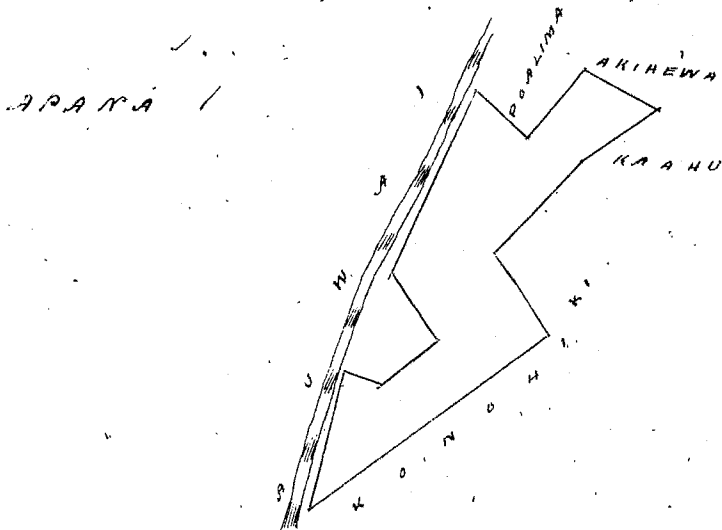

Hand 2 In. 1.

Wm. Pau Lea \$4
 W. L. Lee
 S. M. Robertson
 J. M. Smith
 J. Kekaulaao

Honolulu 27 Oct 1852.

Heleu 3434 Kawaamakua

Waieae Maui.

Apana I. Ili Kaulapulepe I E hoomaka ana ke ana ma ke kahi Komohana o Kekumoku. Aka 64 1/4
 Heikina 67 Kaulahas, a hiki ana ke kahi o Kiwa (Nema) Aka 35 1/4. Heikina 140 Kaulahas ma ke
 Poalima, Aka 60. Heikina 318 Kaulahas ma ke Kanahiki o Kapiku. Nema 3 1/4. Komohana 159
 Kaulahas ma ke Loko. Nema. 64 1/4. Komohana 2,20 Kaulahas, ma ke Kekumoku, a hiki ana kahi i
 hoomaka'i, a maloko via awapuni 35/100 Eka.

Apana II. Ili Kaulapulepe II E hoomaka ke ana ma ke kahi Komohana o Kekahuna
 Nema 20 1/2 Heikina 89 Kaul. ma Kekahuna; Nema 66. Kom. 125 Kaul. ma ke Poalima Aka. 18.
 Kom. 61 Kaul. ma ke Poalima, Nema. 49 1/2. Kom. 95 Kaul. ma ke Poalima, Nema. 36 1/4. Heik 44
 Kaul. ma ke Poalima Aka. 57 1/4. Heikina 67 Kaul. ma ke Poalima Nema. 19 Heik 95 Kaul.
 Kom. 65 1/2. Kom. 331 Kaul. ma ke Maikaloa, Aka. 26 Kom. 60 Kaul. ma ke Napela.
 Aka. 41 1/2. Heik 40 Kaul. ma ke Poalima Aka. 40 1/4. Kom. 132 Kaul. ma ke Poalima,
 Aka. 68. Heik 140 Kaul. ma ke Laupahulu, Aka. 68 Heik 348 Kaul. ma ke Kawaa o Aki
 a hiki ana kahi i hoomaka'i, a maloko via awapuni 72/100 Eka.

Apana III Ua ae no Kawaamakua Ke ana kiwa apana iloko ke Kuluana o
 Kekahuna.

Waikuku, July 20, 1852.

John S. Lowry.
 Mea ana aina

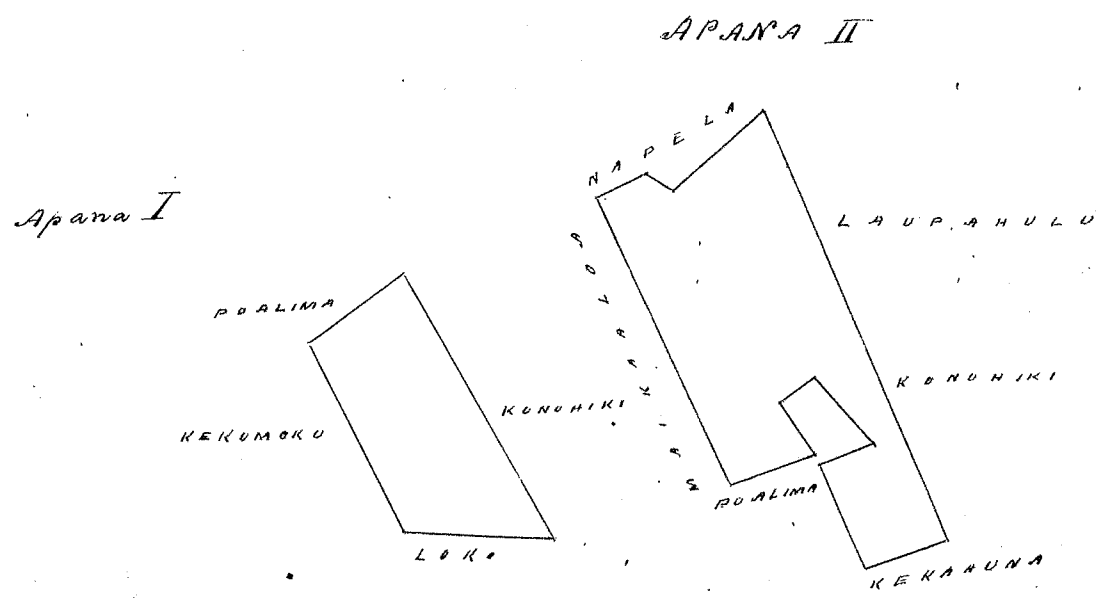

Uku Pau Loa # 5.
 W. L. Lee
 G. M. Robertson
 J. H. Smith
 J. Nekaualakao

Honolulu 27 Oct 1852.

Kellu 3721 Makale

Waikuu Maui

Apawa I. Ili Waikamaawa. E hoomaka ke ana ma ke kahi mua o Kuahewa, Apawa I. Nema 86 3/4° Kom. 58 Kaul. ma Kuahewa, Nem. 21° Kom. 153 Kaul. ma Kuahewa, Nema 51° Kom. 175 Kaul. ma Kuahewa, Nem. 52 1/2° Hike 182 Kaul. ma Poalima, Ak. 80° Hike, 80 Kaul. ma Poalima, Ak. 60° Hike 89 Kaul. ma ka Poalima, Ak. 70 1/4° Hike 70 Kaul. ma ka Pila, Akau 14 3/4° Komohana 57 Kaul. ma ka Poalima, Akau 80 1/2° Hike 73 Kaul. ma Poalima, Akau 10 1/2° Komohana 172 Kaulakaa ma Papohaku, Ak. 74 1/2° Kom. 152 Kaul. ma Poalima, a hiki ma kahi i hoomaka'i, a maatke via anapuni 96/100 Eka.

Apawa II Ili Waikamaawa E hoomaka ke ana ma ka paha Kulu. Kahunu, Apawa III Nem. 71 3/4° Hike 109 Kaul. ma Kulu, Nem. 5 1/2° Kom. 19 Kaul. ma Kulu, Ak. 82 3/4° Kom. 99 Kaul. ma ka Anuainui, Ak. 56° Kom. 87 Kaul. ma ka Anuainui, Ak. 43 1/2° Hike, 41 Kaul. ma Konoiki, Nem. 53 Hike 55 Kaul. ma Kahunu, a hiki ma kahi i hoomaka'i, a maatke via anapuni 9/100 Eka.

Wailuku July 7 1852

John S. Gove,
 Mea ana aina

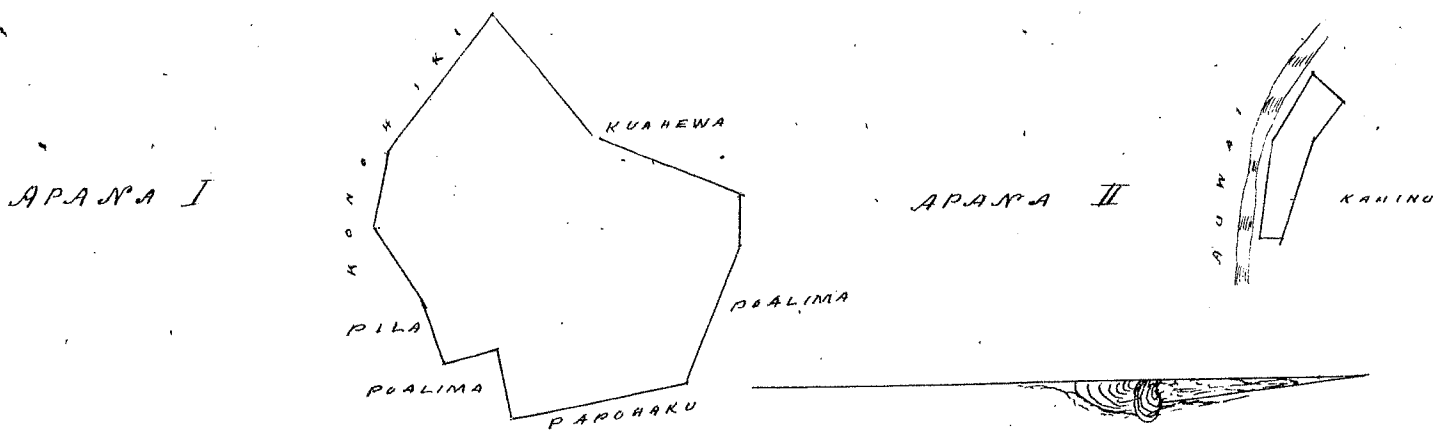

Kaul. 2 An. 1.

Uku Pau Loa # 5.
 W. L. Lee
 G. M. Robertson
 J. H. Smith
 J. Nekaualakao

Honolulu 27 October 1852.

Kellu 4303 & 4304 Kekahuna

Waikuu Maui

Apawa I. Ili Kalepulepe, E hoomaka ke ana ma ke kahi Komohana o Pimaiwaa Nem. 64 1/2° Kom. 103 Kaul. ma Konoiki, Nem. 28 1/2° Hike 153 Kaul. ma Konoiki, Nem. 20 1/2° Hike 148 Kaul. ma Pimaiwaa, Ak. 81 3/4° Hike 189 Kaul. ma Pila, Ak. 10° Kom. 220 Kaul. ma Pimaiwaa Nem. 65° Kom. 60 Kaul. ma Pimaiwaa, Ak. 50 1/2° Kom. 173 Kaul. ma Pimaiwaa, a hiki ma kahi i hoomaka'i, a maatke via anapuni 59/100 Eka.

Apawa II & III Ili Kalepulepe, E hoomaka ke ana ma ke kahi Akau o Maikaaia, Nem. 66° Kom. 86 Kaul. ma ka Maikaaia, Akau 20 1/2° Kom. 185 Kaul. Poalima & Kawamaku, Ak. 52 3/4° Hike 212 Kaul. Poalima & Kawamaku, Nem. 12 1/2° Hike 241 Kaul. ma Poalima, Nem. 70 1/2° Kom. 83 Kaul. ma Kikaula, a hiki ma kahi i hoomaka'i, a maatke via anapuni 4/100 Eka.

Wailuku, Aug. 20, 1852.

John S. Gove,
 Mea ana aina

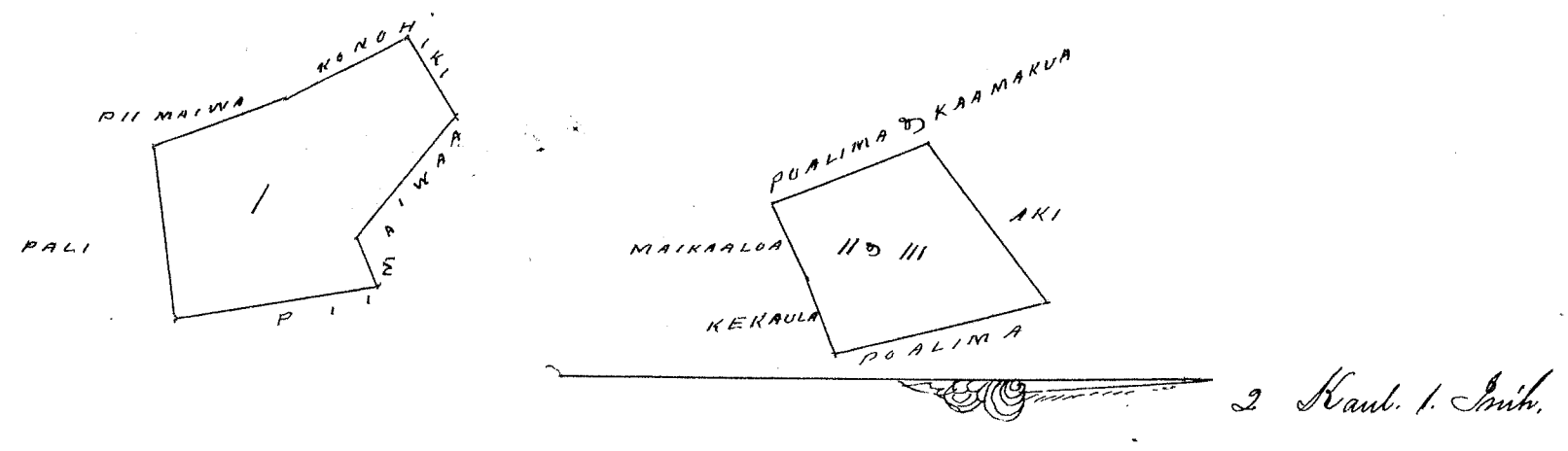

Uku Pau Loo
 W. L. Lee
 G. M. Robertson
 M. Smith
 J. Kikaulaha

Honolulu 27 Octobr. 1852

Hulu 4063 Kanehekili / Waikaeae Manu

Ili Waikaeae. E hoomaka ke ana ma ke kiki Kikina Hema + Keia, e pili ana me ke alanui, Hema 75 1/2 Komohana, 60 Kaulahas ma ka Poalima o Pila, Akau 7 Komohana 62 Kaulahas ma ka Poalima, o Pila, Hema 68 Komohana 35 1/2 Kaulahas ma ka Papohaku, Akau 16 1/2 Komohana 80 Kaulahas ma ka Poalima, Hema 70 Komohana 67 Kaulahas ma ka Poalima, Hema 16 1/2 Kikina 82 Kaulahas ma ka Poalima, Hema 68 Komohana 106 Kaulahas ma ka Papohaku, Akau 21 Komohana 142 Kaulahas ma Poalima Hema 70 Komohana 83 Kaulahas ma ka Poalima, Hema 21 Kikina 144 Kaulahas ma ka Poalima, Hema 68 Komohana, 155 Kaulahas ma ka Papohaku, Akau, 21 1/4 Komohana, 53 Kaulahas ma ka Kuahuwa, Hema 77 Komohana 23 Kaulahas ma ka Kuahuwa, Akau, 15 Komohana 163 Kaulahas ma ka Poalima, Akau 69 1/2 Kikina 92 Kaulahas ma ka Kawiloheli, Hema 24 1/2 Kikina 60 Kaulahas ma ka Poalima, Akau 81 Kikina 67 Kaulahas Poalima, Akau 22 1/2 Komohana 75 Kaul. ma Poalima, Akau 67 Kikina 143 Kaul. Kawiloheli, Hema 18 1/2 Hiki 185 Kaul. ma Poalima, Akau 70 Hiki, 82 Kaul. ma Poalima, Ak. 18 1/2 Kom. 187 Kaul. ma Poalima, Ak. 67 Hiki 90 Kaul. Kawiloheli Hema 22 Hiki 195 Kaul. ma Poalima, Ak. 76 3/4 Hiki 63 Kaul. Poalima, Hema 9 Hiki, 100 Ak. ma ke alanui, a hiki ma ka i hoomaka i, a maloke via anapuni, 1 4/10 Eka,

Poalima E hoomaka ke ana ma ke kiki Hema + Keia Kikina Ak. 5 1/2 Kom. 50 Ak. a hiki ma ke kiki o Keia Poalima, Ak. 15 Kom. 100 Kaul. Ak. 72 1/2 Hiki, 61 Kaul. Kom. 15 Hiki 100 Kaul. Kom. 72 1/2 Kom. 61 Kaul. a hiki ma ka pahu ma, a maloke via anapuni, 6/100 Eka.

Waikaeae, July 7, 1852

John S. Lewis,
 Mea ana aina.

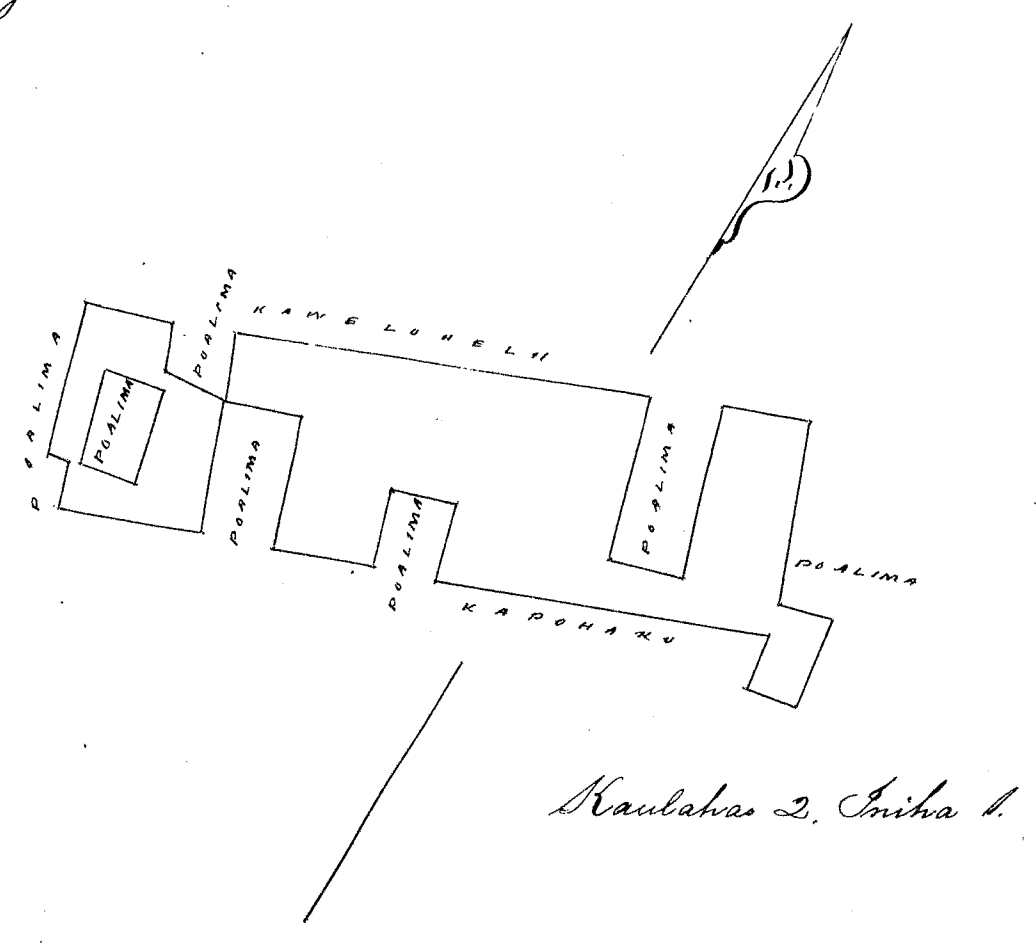

Uku Pan Loa / 5
 W. L. Lee
 G. M. Robertson
 J. H. Smith
 J. Kekaulaha

Honolulu 27 Oct 1852.

Hele 6389 Kahalelole ✓

Matalo ke ano Alodio

Pauwāi Lahaina

Ki ana ana i kekahi mau apama aina o Kahalelole ma ke Ahupuaa o Pauwāi ma Lahaina Maui. E Botua mau. Apama.

Apama 1. Pahale. E hoomaka ke ana ma ke kiki Hikina. Keia pu, ma kahi i pili ai ia Hāiki a me ke ala Anupuni a holo aku. Ak. $39\frac{1}{4}$. Kom. 145 Kaulahao ma ke Hāiki Kom. $18\frac{1}{2}$. Kom. 384 Kaulahao ma ke S. Baluina, Kom. $55\frac{1}{2}$. Heiki: 0.48 Kaulahao ma ke S. Baluina, Akau. $32\frac{1}{4}$. Heiki 327 Kaulahao ma ke Ala Anupuni, a hiki i kahi i hoomaka i. Ka ili 1 Ruda, 9 Ruda.

Apama 2. Pauku aina Kalo. E hoomaka i ke Kahula kama. Konoheki a holo aku. Heema $12\frac{1}{2}$. Heiki. 256 Kaulahao ma Kahula. Akau $75\frac{1}{2}$ Heiki 0.78 Kaulahao ma Nakaikuaana Akau 6 Kom. 277 Kaulahao ma ke auwai hou, Kom. 65 Kom. 1.10 Kaulahao ma Konoheki, a hiki i kahi i hoomaka i. Ka ili oia Apama aina 1 Ruda.

Ua hooheia aku keia Kuleana matalo iho, ke Ano Alodio.

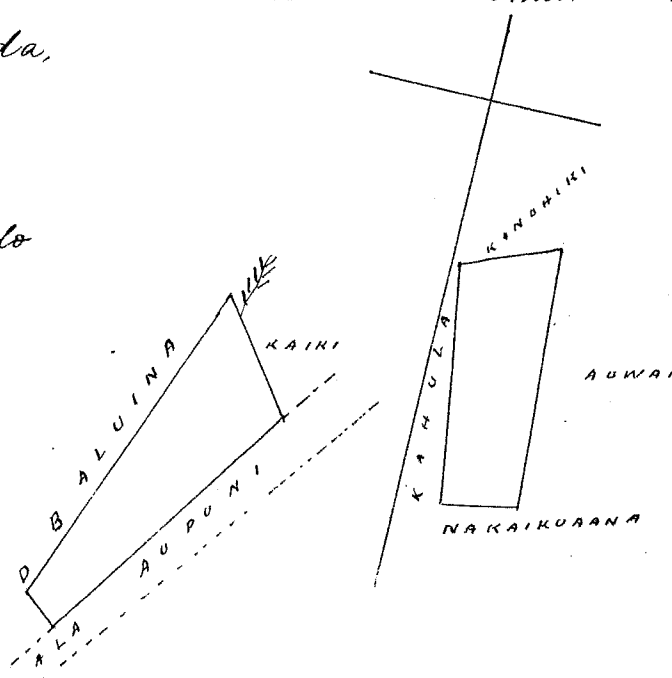

L. S. Ua
 Mea ana aina

Uku Pan Loa / 6

W. L. Lee
 G. M. Robertson
 J. Kekaulaha
 J. H. Smith

Honolulu 25 Nov. 1852

Hele 5207 B. Kalaipaihala ✓

Maamao Olowalu Maui

Ke ana ana i kekahi mau apama aina. Kalaipaihala, ma ka ili "Maamao" a me "Kahuaokahu". ma ke Ahupuaa Olowalu, Mokuapuni o Maui.

Apama 1. Pauku aina Kalo ma Maamao. E hoomaka ana ma ke kiki Komoana. Keia aina ma kahi i pili ai i Kahawai, a me ka pali, a e holo ana, Kom. $79\frac{1}{2}$. Heiki, 600 Kaulahao ma Kahawai, Akau 38 Heiki 164 Kaul. ma Kahawai, Akau. 215 Kaul. ma Kahawai, Kom. 53, Kom. 215 Kaul. ma Pali, Kom. $78\frac{1}{2}$. Kom. 5,28 Kaul. ma ka pali, a hiki i kahi i hoomaka i. Ka ili 3 Ruda 30 Ruda.

Aprila 4 1852
 Lahaina

L. S. Ua
 Mea ana aina

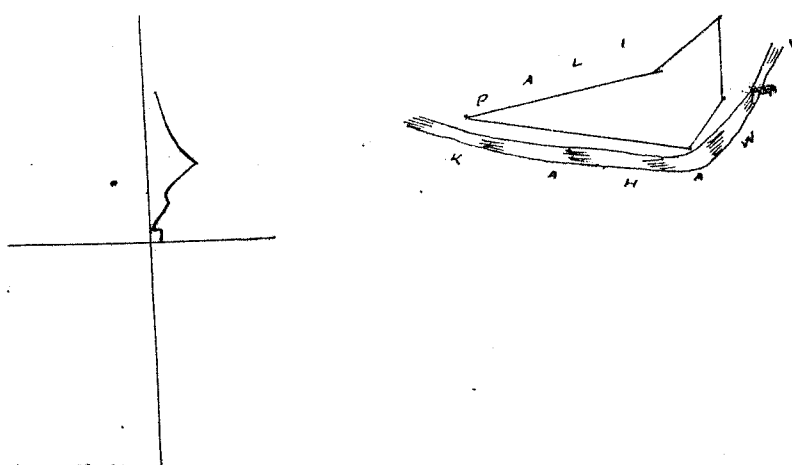

Uku Pau Lea p 4

W. L. Lee
G. M. Robertson
S. Kekaulahao
J. H. Smith

Honolulu 25 Nov 1852

Hulu 5904 Pola Ap 2

Kaanapali
Honokowai Maui

Ke ana ana i kekahi Apawa aina o Pola, ma ka ili o Naunauahawele Ahupuaa o Honokowai, i ka Motupuni o Maui.

Apawa aina kalo. E hoomaka ana ma ke kahi Nema o keia aina, ma kahi i pili ai i Kahawai, a me ke S. Kalaitini, a e holo ana, Ak. 8; Hike 216 Kaul. ma ke S. Kalaitini, Ak. 85 1/4; Kom. 0.43 Kaul. ma ke S. Kalaitini, Ak. 4; Hike 347 Kaul. ma ke Kula a hiki i ke ana, Nema; 85 3/4; Hike 5.43 Kaulahao ma ka pali; Kom. 5; Kom. 3.00 Kaulahao, ma ke Kula a hiki i Kahawai; Kom. 54 Kom. 2.40 Kaulahao ma Kahawai; Kom. 75 3/4; Kom. 3.37 Kaulahao ma Kahawai, a hiki i kahi i hoomaka i. O kona ili 2 Eka 1 Ruda 32 Ruda.

L. S. Ua,
Mea ana aima

Lahaina 23 Maraki 1852.

Patented
March 18 1854

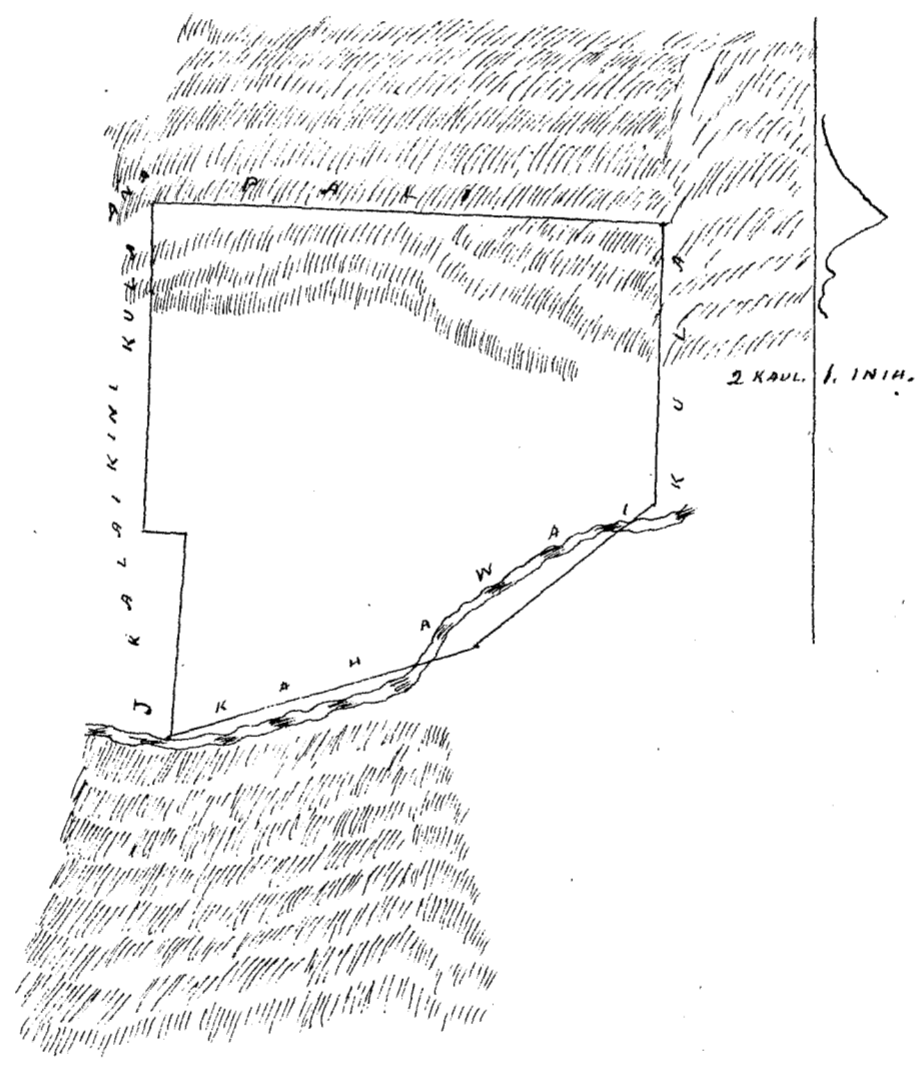

Uku Pau Lea p 4

W. L. Lee
G. M. Robertson
S. Kekaulahao
J. H. Smith

Honolulu 25 Nov 1852

Hulu 4878 Sheole

Puunau Lahaina Maui

Aia Nema Kuleana ma ke Ahupuaa o Puunau, ma ke awaawa o Kawaula, ma Lahaina i Maui.

E hoomaka ana ma ke kahi Nema Nihina A holo aku, Akau 1; Hike 0.79 Kaulahao, a pili ana me ke Puulima o Kalaohina, Kom. 88 1/4; Kom. 2.27 Kaulahao i pili ana me ka pali o Puunau, Kom. 25; Hike 101 Kaul. a pili ana i ke aina o S. Ak. 82 1/4 Hike 186 Kaul.

e pili ana me ke Kahawai, a hiki hui aku i kahi i hoomaka'i
Ka elli Iwakalua kumamawa Roda.

Mr. P. Alexander
mea ana aina

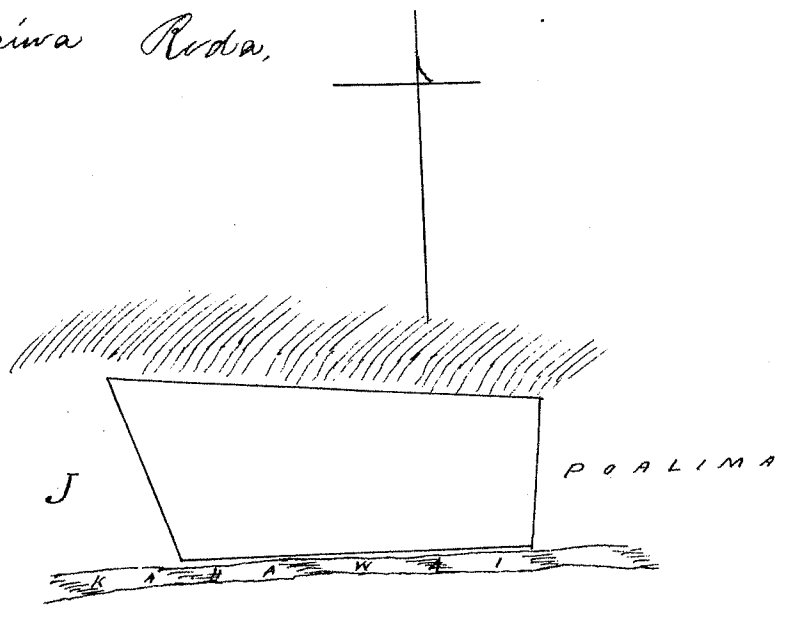

Uku Pau Loa # 3.

W. L. Lee
G. M. Robertson
S. Kekaulaha
D. H. Smith

Honolulu 25 Nov 1852.

Helu 5387 Hinau

Ukumehame Maui

Ke ana ana i kekahi mau Aprana aina. Hinau ma ka Ahupuaa. Ukumehame ma ka Moku-puni
o Maui.

Aprana I. He Loi hookeahi ma ka ili o Ohiaiki, E hoomaka ana ma ke kahi o ka Kahawai
heia loi, ma kahi e pili ana i D. Malo, a me ma Loi puahe a holo ana, Ak. 50. Hiki 148 Kaulaha ma
ke D. Malo, Kum. 63 1/2, Hiki 203. Kaulaha ma ke Hilo, Kum. 25 1/2, Kum. 153 Kaulaha ma ka loi poalima
Akau. 68. Kum. 213, Kaulaha ma ka loi poalima, a hiki i kahi i hoomaka'i, Ka ili, 1 Roda, 6 Roda,

Ukumehame March. 1851.

L. S. Wa.

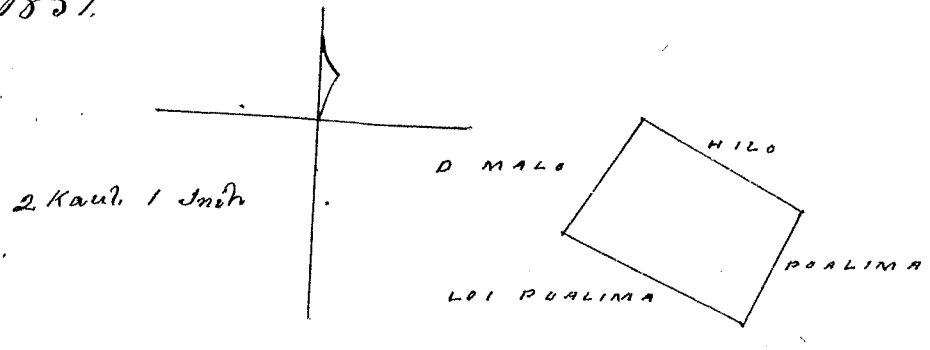

Uku Pau Loa # 2.

W. L. Lee
G. M. Robertson
S. Kekaulaha
D. H. Smith

Honolulu 25 Nov 1852.

Helu 6751 Aloi

Ukumehame Maui.

Ke ana ana i kekahi mau Aprana aina. Aloi, ma ka Ahupuaa. Ukumehame ma ka Moku-puni o Maui

Aprana II. He mau loi kalo ma ka ili o Puaaloa, E hoomaka ana ma ke kahi o ka Kahawai
heia aina, kahi i pili ai i ka aina, Kalua, a me ka auwai, a e holo ana, Kum. 80. Hiki. 317 Kaulaha
ma ke Kalua a hiki i ka auwai, Kum. 8 1/4, Kum. 177 Kaulaha ma ka auwai, Ak. 75 1/4, Kum. 342 Kaul.
ma ke Kahawai o Hamai, a hiki i ka auwai, Ak. 17 1/2, Hiki 149 Kaulaha ma ka auwai, a hiki i kahi
i hoomaka'i, Ka ili 1 Roda, 28 Roda,

Aprana III He mau loi kalo ma ka ili o Puaaloa, E hoomaka ana ma ke kahi o ka Kahawai, kahi e
pili ana i ka aina o Kahawai, a me ka auwai, a e holo ana, Kum. 77 1/4. Hiki 236 Kaulaha ma ke Kahawai
lii, Kum. 24. Kum. 169 Kaulaha, ma ke Kahawai, Ak. 69. Kum. 200 Kaulaha ma ke Kalua, Akau 9.
Hiki 139 Kaulaha, ma ka auwai, a hiki i kahi i hoomaka'i Ka ili 1 Roda 12 Roda.

Apana 11 He kula ma ka ili. Puwala, Chomaka ana ma ke kiki Kama Kikina. Keia aia ma kaahi i pili i ke kula a ma ke alanui e holo ai i Mailuku a e holo ana. Ak. $27\frac{1}{4}^\circ$ Hike 850 Kaula kahao ma Kula. Kem. $74\frac{1}{4}^\circ$ Hike 155 Kaulahao ma ke Kula. Ak. 16° Hike 138 Kaulahao ma ke Kula. Ak. 34° Hike 126 Kaulahao ma ke Kula. Ak. 16° Hike 970 Kaulahao ma ke Kula. Ak. 37° Hike 087 Kaulahao ma ke Kula. Ak. 50° Hike 090 Kaulahao ma ke Kula. Ak. 68° Hike 101 Kaul. ma ke Kula. Ak. 55° Hike 069 Kaulahao ma ke Puanai Kama. 87° Kem. 103 Kaulahao ma ke Puanai Kem. $63\frac{3}{4}^\circ$ Kem. 954 Kaulahao ma ke Puanai. Kama 47 Kem. 700 Kaulahao a hiki i ke alanui Kem. 53 Hike 560 Kaulahao ma e holo ana ma ke alanui, a hiki ma kaahi i hoomaka i Ka ili 4 Eka, 1 Ruda 26 Ruda.

Ukumehame March 1852.

L. S. Ua
Ma ana aia

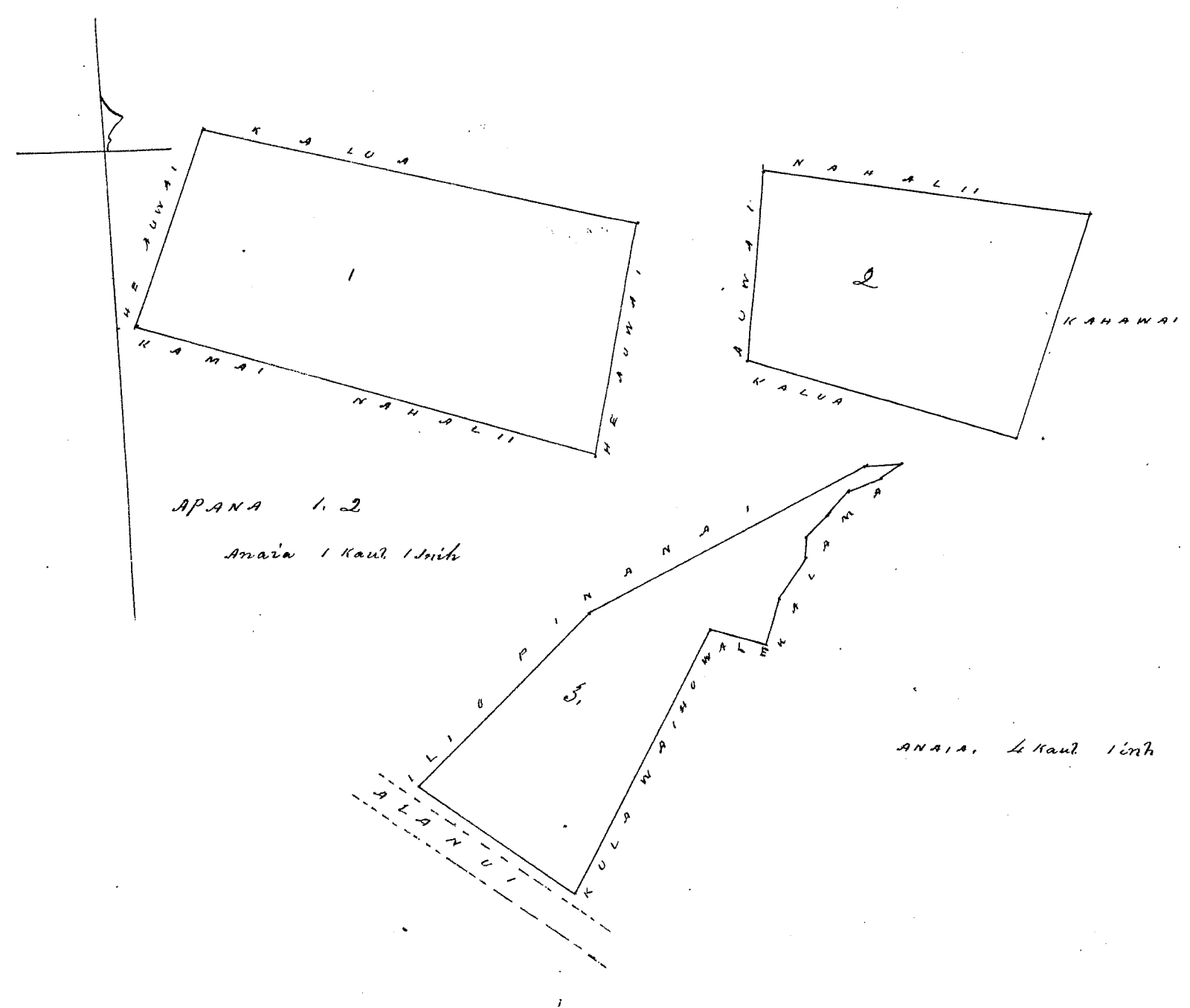

Uku Pau Loa / 6
 W. L. Kei
 G. M. Robertson
 J. Kaulahao
 C. H. Smith

Honolulu 26 Nov 1852

Kelli 8623 Kamakakihau Ukumehame Maui

Ke ana ana i ka kaahi Apana aia. Kamakakihau, ma ke Ahupuaa. Ukumehame i ka Mokup. Maui.

Apana 2. He aia kato ma ka ili o "Puwala", Chomaka ma ke kiki Akau Komohana. Keia aia ma kaahi i pili ia Opulua, kawa o Kulou e holo ana. Kem. 35° Kem. 474 Kaul. ma Opulua Kulou i Kalaitini Lapuwale. Kem. 43° Kem. 326 Kaulahao ma ke Kaulahao. Kem. 62° Hike 365 Kaul. ma Lapuwale Ak. $17\frac{1}{2}^\circ$ Hike 810 Kaul. ma Kahawai. Ak. $63\frac{3}{4}^\circ$ Kem. 080 Kaulahao ma Kulou, a hiki ma kaahi i hoomaka i Ka ili 1 Eka, 2 Ruda 22 Ruda

Ukumehame March 1851.

L. S. Ua.
Ma ana aia

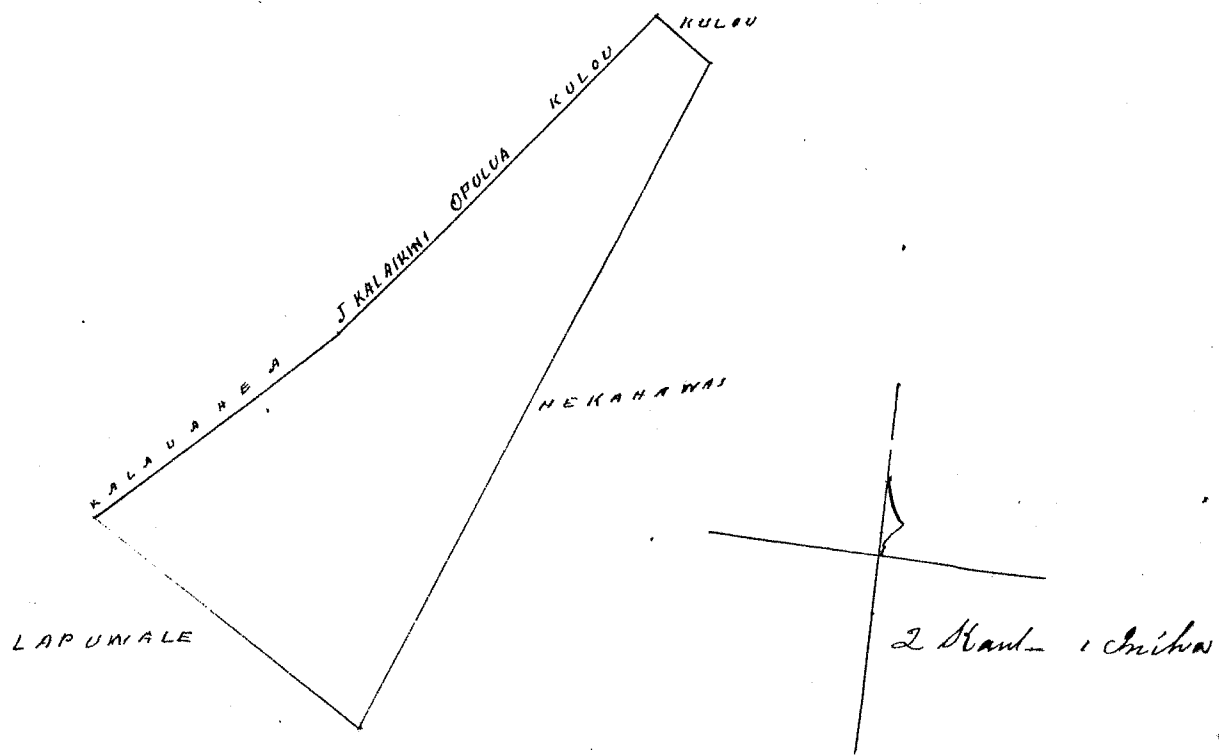

Uku Pau Loa / 5.

W. L. Lee
 G. M. Robertsow
 S. Akauahao
 J. H. Smith

Honolulu 26 Nov 1852.

Nellu 310 K. Pihanele

Ukumehame Maui.

Ke ana ana ina Apama aina o K. Pihanele ma na ili o "Kauli", a me "Uwai", ma ke Akupuaa o Ukumehame, ma ke Motupuni o Maui.

Apama 1. Ke aina kato o "Kauli". E hoomaka ana i kahi i pili ai, i ke Kahawai o pali, a holo aku: Akau 9° Komohana 751 Kaulahas ma ke pali, Akau 31° Heikina 208 Kaula'ao ma ke pali, Akau 51° Heikina 193 Kaul. ma ke pali, alaila Hem. 69 1/4. Komohana 268 Kaul. ma Kahawai, Hem. 36 Komohana 280 Kaul. ma Kahawai, Hem. 20° Hem. 269 Kaul. ma Kahawai, Hem. 7° Heik. 283 Kaul. ma Kahawai, Hem. 62 Heik. 383 Kaul. a hiki ma kahi i hoomaka'i, Eia ka ili 2 Eka, 2 Rudi, 13 Roda,

Apama 2, Aina kato o "Uwai" E hoomaka ana ia Keawe, o auwai a holo aku i, Hem. 58 1/2. Heik. 260 Kaul. ma ke Keawe, Ak. 13° Heik. 280 Kaul. ma Kahawai, Ak. 35° Hem. 112 Kaul. ma Kahawai, Akau 155 Kaul. ma Kahawai, Hem. 69° Hem. 255 Kaul. ma ke Keawe, Mautuole Poal Hem. 4° Heik. 291 Kaul. ma ke auwai, a hiki i kahi i hoomaka'i, Eia ka ili 1 Eka 1 Rudi 13 Roda,

Lahaina 8 Feb 1852.

L. S. Uai
 Mea ana aina

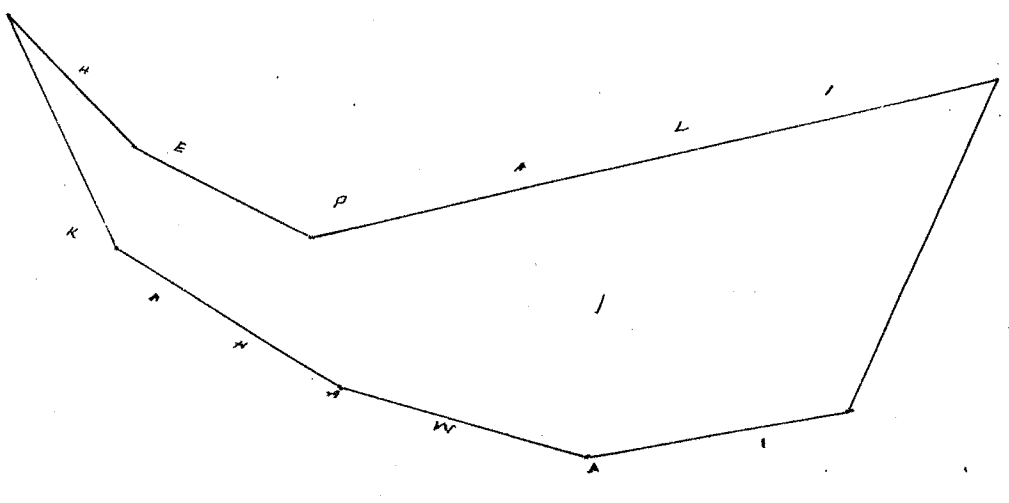
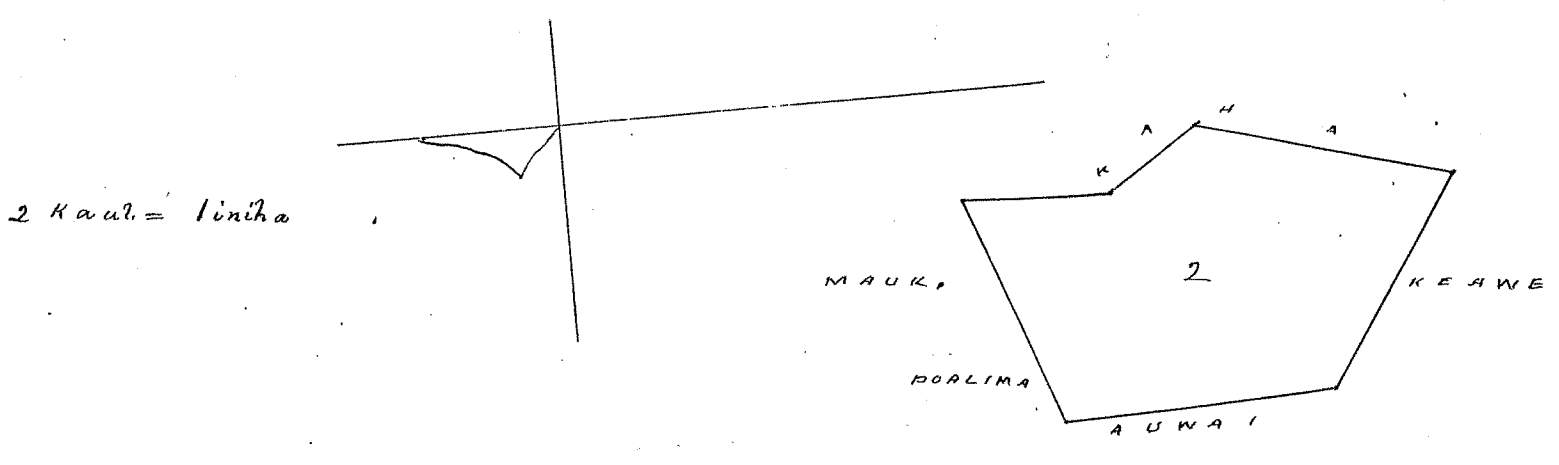

Uka Pau Loa #6

W. L. Lee
G. M. Robertson
J. H. Kaulahao
J. H. Smith

Honolulu 26 Nov. 1852

Kele 4417 Kewili

Maheo Maui

Apana I Ili Papaina. E hoomaka ke ana ma ke kahi Komoana o Kuamo. Ak. 55' Heke 30' Skh a hiki ma ke kahi Mewa o Kira. Ak. 55' Heke 270' Skh ma Kuamo. Ak. 59' Heke 88' Kaul. ma Kuamo Ak. 27 1/4' Kom. 80' Kaul. ma Kalua. Ak. 30' Kom. 62' Kaul. ma Paiki. Kom. 66 1/2' Kom. 157' Kaul. ma Paiki Kom. 28 1/4' Heke 90' Kaul. ma Poalima. Kom. 54' Kom. 100' Kaul. ma Poalima. Ak. 33' Kom. 113' Kaulahao ma Poalima Kom. 83' Kom. 57' Kaul. ma Poalima. Kom. 34 1/2' Heke. 67' Kaul. ma Poalima. Kom. 47 1/2' Kom. 113' Kaul. ma Poalima. Kom. 31 1/4' Heke 135' Kaul. ma Poalima a hiki ma kahi i hoomaka i a maloko oia anapuni. 45/100 Eka.

Apana II Ili Halepule. E hoomaka ke ana ma ke pahu aha o Ahihewa Ak. 28 1/4' Kom. 167' Kaul. ma Paahio Ak. 64 1/2' Heke 51' Kaul. ma Poalima. Kom. 31' Heke 155' Skh ma Kauli. Kom. 53' Kom. 56' Kaul. ma Ahihewa, a hiki ma ke pahu mewa, a maloko oia anapuni. 8/100 Eka.

Apana III Ili Waipae E hoomaka ke ana ma ke kahi Mikiina. Nov. Ap 2 Ak. 40 1/2' Heke. 359' Kaul. ma auwai. Ak. 50' Kom. 118' Kaul. ma Konoiki Kom. 59' Kom. 342' Skh ma Kauli. Kom. 38' Heke 217' Kaul. ma Nov. a hiki ma kahi i hoomaka i a maloko oia anapuni. 59/100 Eka.

Apana IIII Aole loa oia

Wailuku, July 9, 1852

John L. Swer.
Mau ana aino.

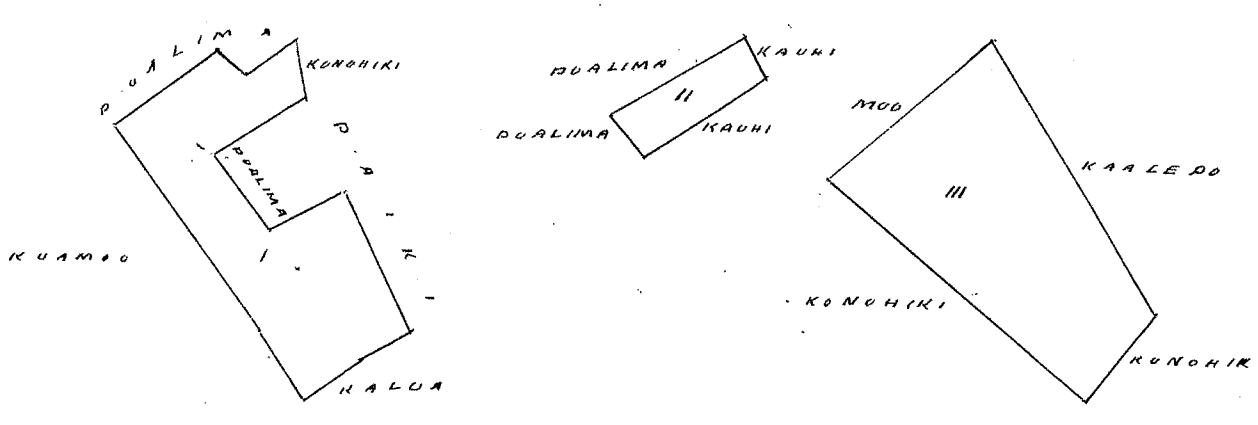

Ke 2 In. %

Uka Pau Loa #5

W. L. Lee
G. M. Robertson
J. H. Kaulahao
J. H. Smith

Honolulu 27 Oct. 1852.

Wella 2474 Keiki

Kaiehu Maui

Mahe I. Apawa I. Ili Kauwilaiki. E hoomaka ke ana ma ke kahi Hihina o Keia, e pili ana me Kahawai.
Ake. 68; Kom. 385 Kaul. ma Kahawai, Kom. 8; Hike. 210 Kaul. ma Poalima, Kom. 68; Hike. 385 Kaul. ma
Pali. Ake. 8; Kom. 210 Kaul. ma Komohiki, a hiki ma kahi i hoomaka'i, a maloko oia anapuni 7/100 Eka.

Apawa I. Mahele II Ili Kauwilaiki. E hoomaka ke ana ma ke kahi Hihina o Keia, mai ke
kahi Komohana Hema o Mahele I. Kom. 70; Kom. 118 Kaul. Kom. 70 1/2 Kom. 336 Kaul. ma Poalima,
Ake. 7; Kom. 243 Kaul. ma Keia, Ake. 77 3/4; Hike 300 Kaul. ma Komohiki, Kom. 15 1/4; Hike 200 Kaul
ma Poalima a hiki ma kahi i hoomaka'i, a maloko oia anapuni, 69/100 Eka.

Apawa II Ili Kaohi. E hoomaka ke ana ma ke kahi Hema o Keia, Ake. 11; Hike. 179 Kaul. ma
Kula. Ake. 77 Hike. 244 Kaul. ma Kula, Kom. 35; Hike 179 Kaul. ma Kula, Kom. 80; Kom. 380 Kaul. ma
Kula, a hiki ma kahi i hoomaka'i, a maloko oia anapuni 53/100 Eka.

John S. Gower.
Ma ana ana.

Waikuku, Aug 18, 1852

70
69
53
7.92

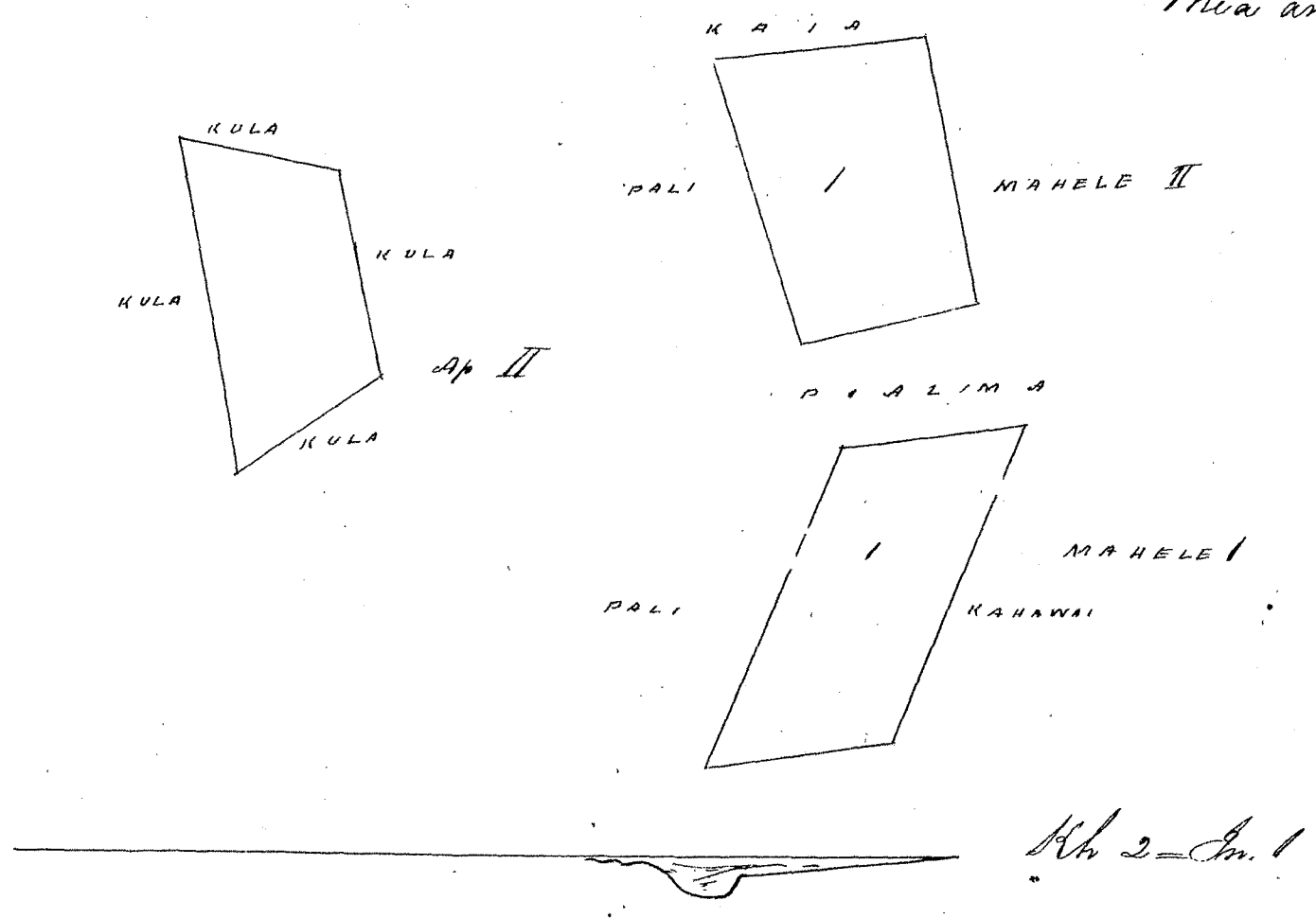

Whe Pau Loa # 6
W. L. Lee
G. M. Robertson
J. Kakaubakao
J. H. Smith

Honolulu 27 Oct 1852.

Wella 5521 Kakaikuaana

Kaamalahua Maui

Apawa 1. Ili Kapahi Komopou. E hoomaka ke ana ma ke kahi Akau e pili ana me Iwitia.
Kom. 47 Kom. 258 Kaul. a hiki ma kela awao, Kom. 23 3/4; Hike 331 Kaul. ma Pali; Ake. 8 1/2; Hike 145
Kaul. a hiki i kela awao Kaopu, Ake. 3; Hike. 356 Kaul. ma Kaopu, Ake. 44 3/4; Kom. 143 Kaul.
ma Komohiki, a hiki ma kahi i hoomaka'i, a maloko oia anapuni, 87/100 Eka.

Apawa 2. Ili Kalaula, Komopou. E hoomaka ke ana ma ke kahi Hema o Keia, Ake. 30 1/2;
Kom. 459 Kaul. ma Komohiki; Ake. 56 1/2; Hike 313 Kaul. ma Komohiki, Kom. 2 1/4; Kom. 565 Kaul. ma
Pali, a hiki ma kahi i hoomaka'i, a maloko oia anapuni, 73/100 Eka.

Apawa 3. Ili Kamania Komopou. E hoomaka ke ana ma ke kahi Hihina Hema o
Iwitia kahi Hihina Akau o Keia, Ake. 83 1/4; Kom. 397 Kaul. ma Iwitia Kom. 59 Kom. 152 Kaul.
a hiki i kela awao, Kom. 53 1/2; Hike 495 Kaul. ma Manoa o Pua, Kom. 51; Hike. 450 Kaul. ma
Hoilawa Ake. 18 3/4 Kom. 626 Kaul. ma ka Pali maluna a hiki ma kahi i hoomaka'i, a ma.

lōko oia anapuni 1²/₁₀₀ Eka.
 Apana I Na māhi ole oia
 Waiuku Aug 26, 1852

John S. Low,
 Mea ana oia,

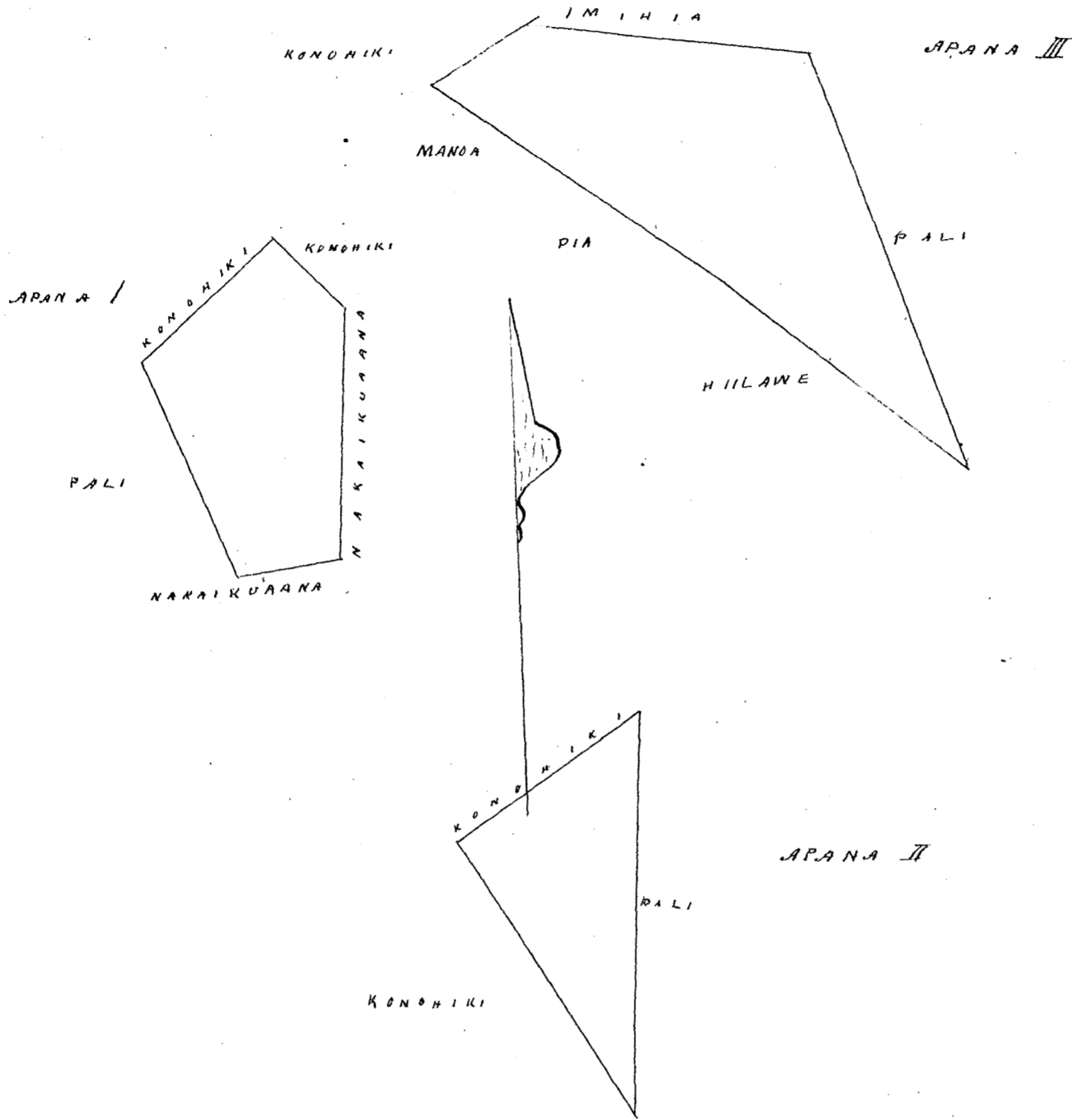

Waiuku Aug 26
 W. L. Lee
 G. M. Robertson
 S. Kaulahao
 J. H. Smith

Honolulu 27 Nov 1852.

Keolu 3258 Laka Waiuku Maui

Mahale I Ili Waiuku. Chomaka ke ana oia ke kiki Konoehana o Keia, Kom. 25.
 Heikina 338 Kaulahao ma Kula, Kom. 5 3/2. Heike. 213 Kaul. ma Pali, Ak. 65. Heike. 208 Kaul.
 ma Konoehana, Ak. 37 1/2, Kom. 130 Kaul. ma Poalima, Kom. 68 Kom. 122 Kaul. ma Poalima
 Ak. 21. Kom. 123 Kaul. ma ke Poalima, Ak. 75. Heike. 54 Kaul. ma Poalima, Ak. 18. Kom. 120
 Kaul. ma Poalima, Kom. 85 1/2, Kom. 80 Kaul. ma Kalamai, Ak. 6 3/4, Kom. 72 Kaul.
 ma Konoehana, Kom. 68, Kom. 203, Kaul. ma Konoehana, Kom. 85, Kom. 104 Kaul. ma Konoehana
 a hiki ma kahi i chomaka i, a maloko oia anapuni, 1 3/100 Eka.

Mahale II Ili Waiuku. Chomaka ke ana oia ke kiki Heikina o Mahale I,
 Ak. 80, Heike. 113 Kaul. a hiki oia ke kiki Konoehana o Keia, Ak. 22 3/4, Kom. 325 Kaul.
 ma Poalima, Ak. 83, Heike. 569, Kaul. ma Konoehana, Kom. 3 1/2, Heike. 139 Kaul.
 ma Konoehana o Kapulu, Kom. 13 1/2, Heike. 117 Kaul. ma Kaulapahi, Kom. 76 1/2, Kom. 491
 Kaulahao ma Konoehana a hiki i kahi i chomaka i, a maloko oia anapuni, 1 49/100 Eka.

Waialuku, Aug 12, 1852

John S. Gower
Mea ana aina

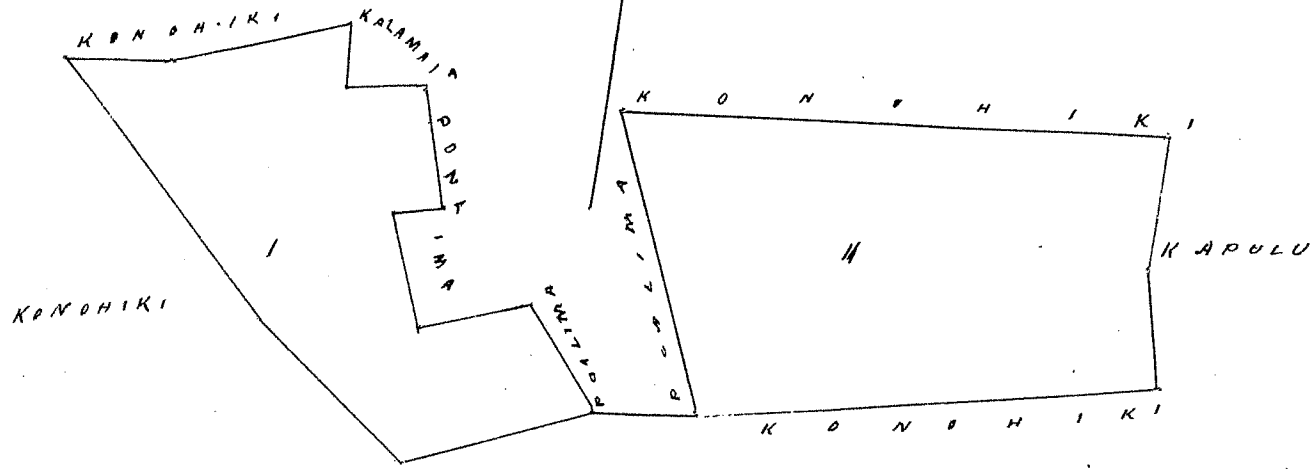

2 Kaul. 1 In.

Ulu Pan Lou # 6

W. L. Lee
G. M. Robertson
J. K. Kaulahoa
J. H. Smith

Honolulu 27 Oct 1852

5522
Hulu 5527 Kaopu

Hoamakuahoa Maui

Apana I. Ihi Papamuku Honopou, E hoamatea ke ana ma ke kahi Komohana o keia, e pili ana me
 Kaitiwaana, Hem. 13 3/4. Heike. 231 Kaul. ma Konehiki, Hem. 74. Heike. 417 Kaul. ma Konehiki, Ak. 55 3/4.
 Heike 341 Kaul. ma Kula, Ak. 50 1/2. Hem. 253 Kaul. ma Kula me Pali, Ak. 46. Hem. 520 Kaul. ma
 Kaitiwaana, Hem. 2. Hem. 356 Kaul. ma Kaitiwaana Hem. 8 1/2, Hem. 145 Kaul. ma ke
 Kaitiwaana, a hiki ma kahi i hoamatea i, a maloko ia anapuni, 2,65/100 Eka.

Apana II Ihi Halaua, Honopou, E hoamatea ke ana ma ke kahi Komohana o keia, e pili
 ana me Kaneloa, Ak. 76 3/4. Heike. 484 Kaul. ma Kaneloa, Ak. 54. Heike. 472 Kaul. ma Pali,
 Ak. 32. Hem. 272 Kaul. ma Pali, Hem. 70. Hem. 515 Kaul. ma Pali, Hem. 46. Hem. 493. Kaul. ma
 Pali, Hem. 49 1/2. Hem. 70 Kaul. ma Pali, Hem. 60 1/2, Hem. 117 Kaul. ma kea pili, a hiki ma kahi i
 hoamatea i, a maloko ia anapuni, 1 68/100 Eka.

John S. Gower
Mea ana aina

Waialuku, Aug 26, 1852,

2.65
1.68
4.33

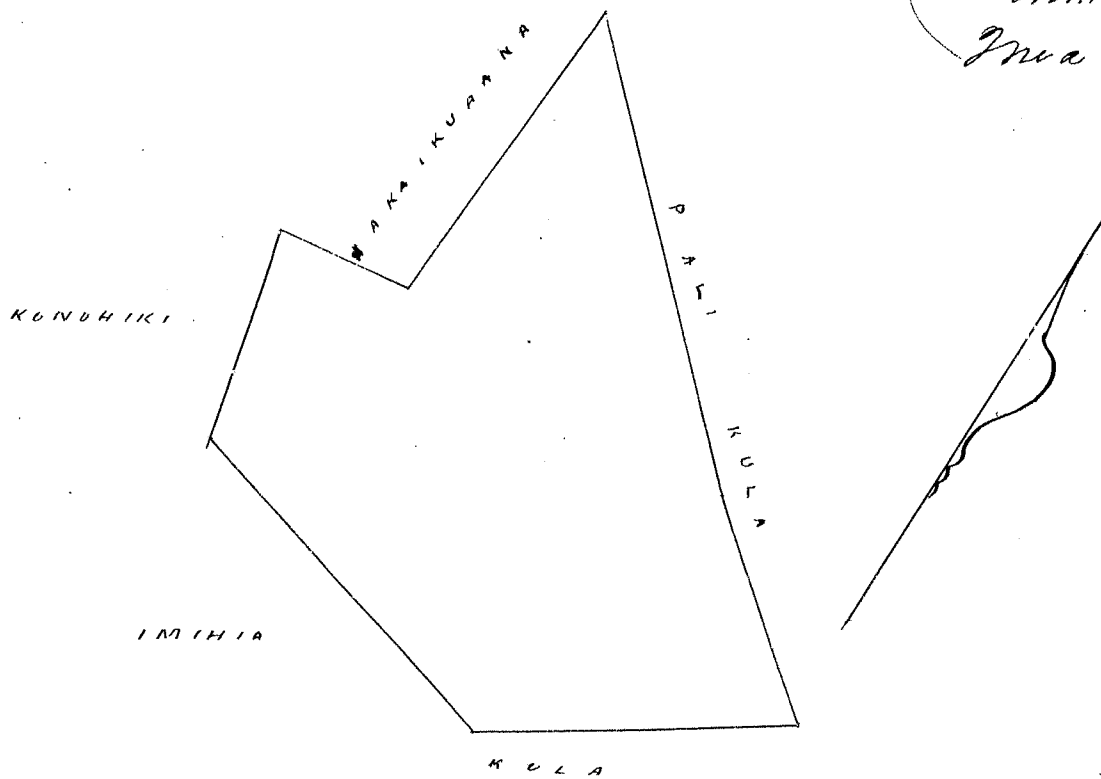

Kaul. 2 - Parika 1.

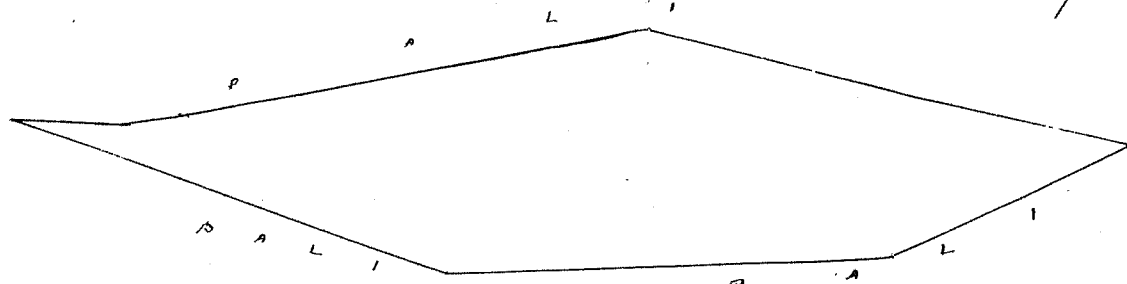

Uku Pau Loa # 7
W. L. Lee
G. M. Robertson
J. Hekeaulahao
J. H. Smith

Honolulu 27 Oct 1852

Kulu 3770 Paiki

Waiehu Maui.

Apana I. Ili Papaina. E hoomaka ke ana ma ke kahi Hikiina o Keia, e pili ana me Keoili
Ak. 38 3/4. Kom. 116 Kaul. ma Honohiki. Hem. 84. Kom. 65 Kaul. ma Honohiki. Ak. 23. Kom. 109 Kaul.
ma Laupahulu. Hem. 7 1/2. Kom. 217 Kaul. ma auwai. Hem. 35 1/2. Hiki. 269 Kaul. ma Pralima.
Ak. 66 1/2. Hiki 275 Kaul. ma Keoili. a hiki ma kahi i hoomaka i, a maloko oia anapuni. 5 1/100 Eka.

Apana II. Ili Koiaki. E hoomaka ke ana ma ke kahi Hikiina o Keia e pili ana me ke kahi
Hikiina o Anakalea. Hem. 56 1/4. Kom. 124 Kaul. ma Anakalea. Ak. 35 1/2. Kom. 45 Kaul. ma
Anakalea. Hem. 58 3/4. Kom. 97 Kaul. ma Anakalea. Akau 25. Komohana 46 Kaulahao ma
Anakalea. Ak. 82. Hiki 237 Kaul. ma Laupulu. a hiki ma kahi i hoomaka i, a maloko oia
anapuni. 11/100 Eka.

Apana III. Ili Ahuakalea. E hoomaka ke ana ma ke kahi Komohana Nema o Keia, e pili
ana me ke kahi Hikiina o Moo. Ak. 66 1/2. Hiki 103 Kaul. ma Kahuwai. Ak. 50. Kom. 71 Kaulahao ma
Kula. Nema 69. Komohana 91 Kaulahao ma Kula. Nema 14 1/4. Hikiina 23 Kaul. ma Moo. Ak. 69.
Hiki 33 Kaul. ma Moo. Hem. 13 1/4. Hikiina 44 Kaulahao ma Moo. a hiki ma kahi i hoomaka i,
a maloko oia anapuni. 6/100 Eka.

Apana IV & V Ua haalile via ia onau Apana.

Wailuku Aug 12. 1852.

John S. Gow.
Pua ana aima.

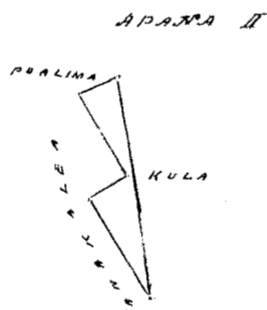
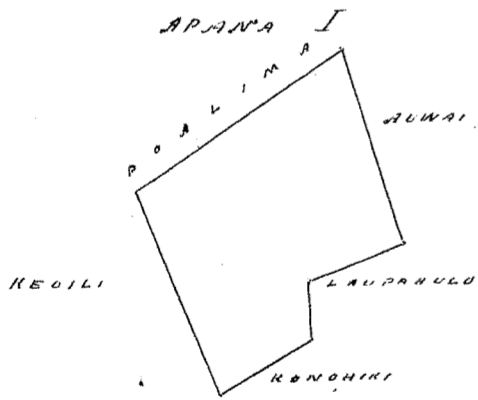

Kaul. 2 In 1/2

Uku Pau Loa # 5.
W. L. Lee
G. M. Robertson
J. H. Smith
J. Hekeaulahao

Honolulu. 27. Oct. 1852.

~~Helele 4444~~ Kaakua

Waikuu Maui

Apana I. Ili Papaina E hoomaka ke ana ma ke kiki Akau o Laupahulu, II
Hem. 67. Kom. 220 Kaul. ma Laupahulu, II Ak. 26 1/2. Kom. 134 Kaul. ma Keapu o Konoehiki, Ak. 76 1/4.
Hike 50. Kaul. ma Auwai, Hem. 22 Hike 80 Kaul. ma Poalima, Ak. 69 1/2. Hike 180 Kaul. ma Poalima
Hem. 16. Hike 34 Kaul. ma Kawaa, a hiki ma kahi i hoomaka'i, u maloko via anapuni 13/100 Eka,

Apana II Ili Papaina E hoomaka ke ana ma ke kiki o Kaakua, (Akau) Hem. 34 1/2 Hike 99 Kaul.
ma Kaakua, Ak. 54 1/2. Hike 62 Kaul. ma Kaakua, Ak. 3. Kom. 95 Kaul. ma Poalima, Hem. 62 1/4. Kom.
64 Kaul. ma Akihewa, a hiki ma kahi i hoomaka'i a maloko via anapuni 6/100 Eka,

Apana III Ili Papaina E hoomaka ke ana ma ke kiki Akau o Kawaa, Hem. 61 1/2, Kom. 75 Kaul.
ma Kawaa, Hem. 21 1/2, Hike 42 Kaul. ma Kawaa, Hem. 60 Kom. 38 Kaul. ma Kawaa, Ak. 42 1/2 Kom.
22 Kaul. ma Kawaa, Ak. 30. Kom. 106 Kaul. ma Poalima Ak. 63 1/2. Hike 111 Kaul. ma Auwai,
Hem. 43. Hike 90 Kaul. ma Ahi a hiki ma kahi i hoomaka'i a maloko via anapuni, 13/100 Eka,

Waialuku, July, 7, 1852

John S. Gower,
Mea ana aina.

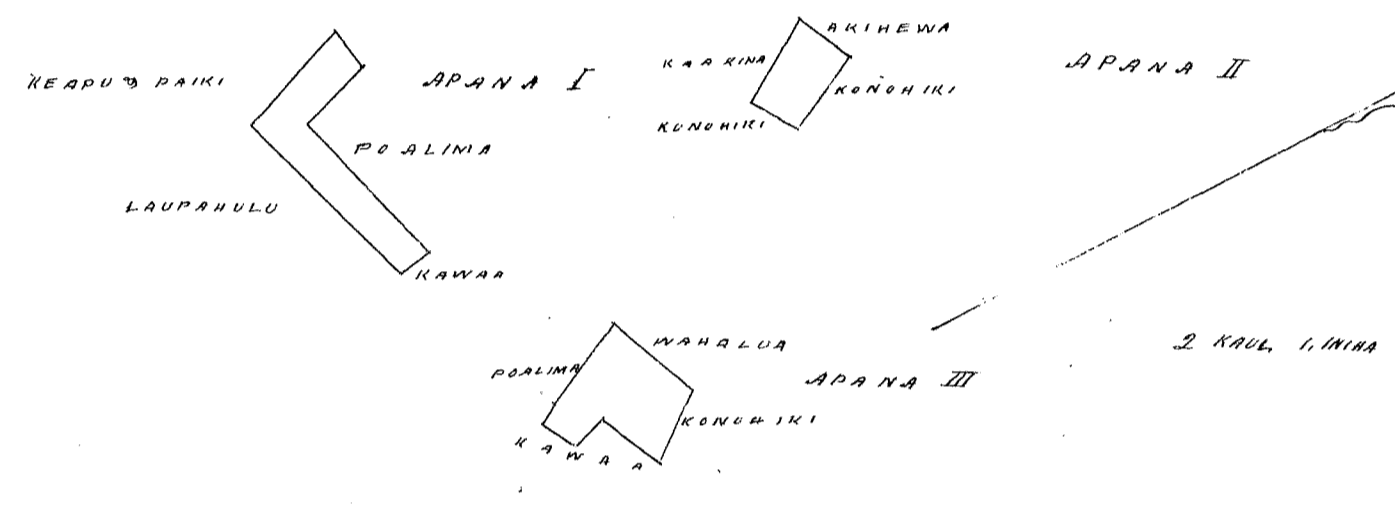

Wm. Pau Lee
W. L. Lee
G. M. Robertson
J. H. Smith
J. Kekaulaao

Honolulu, 27 Oct. 1852

~~Helele 4444~~ Kekaula

Waikuu Maui

Apana I. Mahale I. Ili Mookahi, E hoomaka ke ana ma ke kiki Sikiina o Kekahuna, Hem. 24.
Hike 88 Kaul. ma Poalima, Hem. 66 1/4. Kom. 84 Kaul. ma Pimaisawa, Ak. 50 1/2. Kom. 97 Kaul. ma Maikaaaloa
Ak. 70 1/2. Hike 88 Kaul. ma Kekahuna, a hiki ma kahi i hoomaka'i.

Mahale II E hoomaka ke ana ma ke kiki Sikiina o Maikaaaloa, Ak. 68. Hike 303 Kaul. ma Kea
Maikaaaloa Hem. 24 1/4. Hike 130 Kaul. ma Kea Loko, Hem. 97 3/4. Kom. 303 Kaul. ma Pimaisawa, Ak. 25.
Kom. 78 Kaul. ma Poalima, a hiki ma kahi i hoomaka'i a maloko via anapuni dua, 34/100 Eka,

Apana II Ili Kapoho E hoomaka ke ana ma ke kiki Akau o Kua, i pili ana me Kalua,
Akau 79 1/2. Hike 188 Kaul. ma Konoehiki, Akau. 6. Kom. 85 Kaul. ma Konoehiki, Hem. 79 1/2. Kom. 188 Kaul.
ma Kalua, Hem. 6. Hike 85 Kaul. ma Kalua, a hiki ma kea pahu muu, a maloko via anapuni 16/100 Eka,

Waialuku, July, 7, 1852,

John S. Gower
Mea ana aina

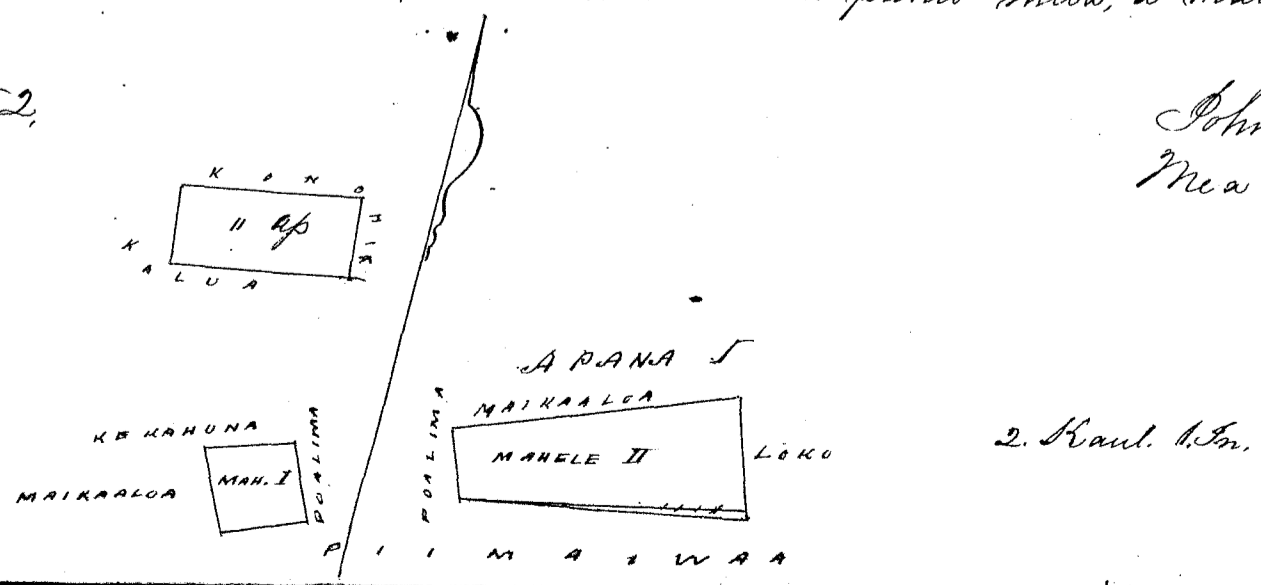

Uku Pau Loa / 4
W. L. Lee
S. M. Robertson
J. H. Smith
J. Kakaulaha

Honolulu 27 Oct 1852.

Kellu 590 B Ikiiki Momonouloa Waikea Kihata Hawaii

Apana 1. Pahale, E hoona ma ke kahi Hikinua maauka o keia pa. a e holo kama 130 Kom. (ma 70 paauku, meuee i ka lima akau, 15 paauku i ka pa. Ma 1.60 Kl. N.S.A 15' i ka pa) 2 1/2 Kaul. a hiki i kahi amahua oioi, o keia pa. - a me kama 12' 30 Kom. (Ma 50 N.S.A, 5' i ka pa Ma 80 N.S.A, 15' i ka pa. - Ma 1 Kl. N.S.A, 8' i ka pa. Ma 1.47 Kl. pili i ka pa, Ma 1.70 Kl. N.S.A, 10' i ka pa.) 235 Kaul. a me Akau 86' 45 Kom. (Ma 8' N.S.A, 8' kahi i ka pa ma ke alanui Kihata. Ma 1.22 Kl. pili i ka pa ma ke alanui.) 122 Kaul. a me Akau, 79 Kom. (Ma 60 N.S.A, 15' i ka pa. Ma 1 Kl. N.S.A, 12' i ka pa. Ma 1.70 Kl. pili i ka pa. - Ma 2.30 Kl. N.S.A, 2' pili i ka pa, kahi hualala poepoe.) 246 Kaul. a me Akau, 49' 15 Kom. Ma ka piko kope. N.S.A 10' pa kahi poepoe. Ma 60' pili i ka pa Ma ka lihi alanui, maauka, a hiki i ke kahi Kom. ma kahi, a me Akau, 25' Hike (Ma 1/2 Kl. pa i ka pa a e holo ana i loko, Ma kahi hoomaka a hiki i keia, Ma ka papahaku Kahiho Ka Mokuna, 5.48 Kaul. ma ka avas Kom. a hiki i kahi waiho wale ma wahi o keia pa. alaila, Akau 88' Hike, 84 Paauku, a hiki i ka pa, matala aku, Kom. 52, 30' Hike 24.7 Kaul. ma ka pa papahaku, a hiki i kahi i hoomaka'i Puni i ke Kauhiki 2 1/5 Eka.

Apana 2 Aina Kula Mahiai. E hoona ma ka wana o ma Kauhawai, elua e moana ma wa avas elua o keia aina e pili ana me ka aina i kapaia o Pauahi ka inoa, a e holo i uka, Ak. 30, 30 Hike 7' 100 Kaul. a me Akau, 10' Hike 1 1/2 Kaul. a me Akau, 3' Hike, 15' 100 Kaul. ma ka lihi kama o ke Kauhawai, i wana o keia a me Pauahi, a hiki i kahi i kupo ana i kahi Lavan Ohia nui, ma ka lima Akau o keia, alaila huli i ka kama, 83' Hike, 1 1/2 Kaul. ma ka avas maauka o keia e pili ana me ke ke Kauhiki, a hiki i ke Kauhawai, ma ka avas Hikinua o keia aina e pili ana me Momonouloa Hikinua, alaila huli i kahi holo ma ke Kauhawai, i wana o keia, me Momonouloa, Hikinua a me ke Kauhiki, a hiki i kahi i hoomaka'i, 3 1/2 Eka.

Maraki, 4, 1851

S. P. Kalamo,
ana aina.

